

PLEASE CHECK WWW.MOLEX.COM FOR LATEST PART INFORMATION

Part Number: [87537-8819](#)
Status: **Active**
Overview: EBBI™ 50D
Description: 1.27mm Pitch EBBI™ 50D Receptacle, Through Hole, Right Angle, Blind Mate, with Beveled Metal Pin and Plastic Peg, 0.76µm Gold (Au) Selective Plating, 68 Circuits, 1.70mm PC Tail Length, without Kapton Tape, Lead-Free

Documents:

[3D Model](#) [RoHS Certificate of Compliance \(PDF\)](#)
[Drawing \(PDF\)](#)

Agency Certification

CSA LR19980
 UL E29179

General

Product Family PCB Receptacles
 Series [87537](#)
 Application Board-to-Board, Signal
 Comments Lubricant at the ContactZ-Height: 3.00mm
 Overview [EBBI™ 50D](#)
 Product Name EBBI™
 UPC 822348542161

Physical

Circuits (Loaded) 68
 Circuits (maximum) 68
 Color - Resin Black
 Durability (mating cycles max) 2,000
 Flammability 94V-0
 Glow-Wire Compliant No
 Guide to Mating Part Yes
 Lock to Mating Part None
 Material - Metal Phosphor Bronze
 Material - Plating Mating Gold
 Material - Plating Termination Tin
 Material - Resin High Temperature Thermoplastic
 Net Weight 4.575/g
 Number of Rows 2
 Orientation Right Angle
 PC Tail Length 1.70mm
 PCB Locator Yes
 PCB Retention Yes
 PCB Thickness - Recommended 1.20mm
 Packaging Type Tray
 Pitch - Mating Interface 1.27mm
 Plating min - Mating 0.762µm
 Plating min - Termination 2.540µm
 Polarized to Mating Part Yes
 Polarized to PCB Yes
 Surface Mount Compatible (SMC) Yes
 Temperature Range - Operating -40°C to +105°C
 Termination Interface: Style Through Hole

Electrical

Current - Maximum per Contact 1A

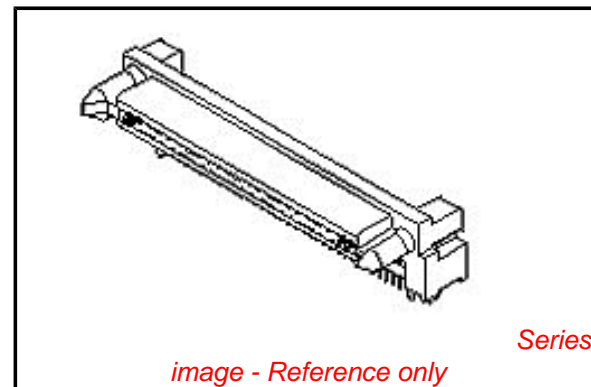

EU RoHS

ELV and RoHS Compliant
REACH SVHC Contains SVHC: No
Low-Halogen Status Low-Halogen

China RoHS



Need more information on product environmental compliance?

Email productcompliance@molex.com
 For a multiple part number RoHS Certificate of Compliance, [click here](#)

Please visit the [Contact Us](#) section for any non-product compliance questions.

Search Parts in this Series

[87537Series](#)

Mates With

[71661 EBBI™ Right Angle Blind Mate Plug](#),
[EBBI™ Vertical Blind Mate Plug](#)

Voltage - Maximum 30V

Solder Process Data

Duration at Max. Process Temperature (seconds) 5
Lead-free Process Capability SMC & Wave Capable (TH only)
Max. Cycles at Max. Process Temperature 1
Process Temperature max. C 265

Material Info

Reference - Drawing Numbers

Sales Drawing SD-87537-002

This document was generated on 07/04/2014

PLEASE CHECK WWW.MOLEX.COM FOR LATEST PART INFORMATION