

Piezo Switch for Explosive Environments



PSE M16 EX

Description

- Piezo switch certified according to ATEX and IECEx Assembly by mounting with nut
- Pins, crimp terminal male, plug-in connector

See below:

Approvals and Compliances

Characteristics

- Housing material types: aluminum, brass chrome-plated or stainless steel
- High reliability, long lifetime with more than 20 mill. actuations
- Easy to clean due to a tightly closed surface (IP 69K)
- for use in harsh environments (see technical data), in potentially explosive applications and environments where volatile fumes, gases and dust are present

References

- Alternative: Standard version
- Alternative: Other diameter

Weblinks

[html-datasheet](#), [General Product Information](#), [CAD-Drawings](#), [Product News](#), [Detailed request for product](#), [Microsite](#)

Technical Data

Electrical Data

Switching Function	N.O.
Switching Voltage	Ui max. 24 / 24 VAC/DC
Switching Current	Ii max. 40 mA
Rated Breaking Capacity (Temperature Class T5/T100°C)	Pi max. 0.96 W
Rated Breaking Capacity (Temperature Class T6/T85°C)	Pi max. 0.7 W
Lifetime	20 million actuations at Rated Switching Capacity
Switch Resistance OFF	> 10 kΩ
Switch Resistance ON	< 20 mΩ
Capacity	5 pF
N.O. Closing Impulse Duration	20- 1000 ms
Contact Configuration	free polarity

Mechanical Data

Actuating Force	≤ 3 N at ambient temperature
Actuating Travel	0.002 mm
Shock Protection	IK 02
Tightening Torque	2.5 Nm

Climatical Data

Operating Temperature	-20 to +60 °C
Storage Temperature	-20 to +60 °C
IP-Protection	IP 67 acc. to IEC 60529, IP 69K acc. to DIN 40050-9
Environmental Assessment	55°C / 93% r.h. acc. to DIN EN 60068-2-30
Salt Spray Test (acc. to DIN 50021-SS)	24 h / 48 h / 96 h Residence Time

Material





Housing (depending on type)	Stainless Steel, Aluminium anodized, Polyamide, Chromed Brass
-----------------------------	---

Approvals and Compliances

Detailed information on product approvals, code requirements, usage instructions and detailed test conditions can be looked up in [Details about Approvals](#)

Approvals

Approval Reference Type:

Approval Logo	Certification Body	Description
	EU	EMC: EMC directive 2004/108/EWG
	EU	ATEX Approval Test Report: SEV 13 ATEX 0170 IECEX SEV 13.0011
	EU	ATEX Approval Marking: Ex II 2 GD Ex ib IIC T6...T5 Gb Ex ib IIIC T85°C...T100°C Db
		MIL-STD Certificate Number: 202F Method 107G, 202F Method 204D, 202F Method 213B, 416D Method RS103, 810E Method 501.3, 810E Method 502.3, 810E Method 507.3 VDE Certificate Number: DIN EN 61000-4-2, DIN EN 61000-4-4

Application standards

Application standards where the product can be used

Organization	Design	Standard	Description
	Designed for applications acc.	IEC/UL 60950	IEC 60950-1 includes the basic requirements for the safety of information technology equipment.

Compliances

The product complies with following Guide Lines

Identification	Details	Initiator	Description
	RoHS	SCHURTER AG	EU Directive RoHS 2011/65/EU
	REACH	SCHURTER AG	On 1 June 2007, Regulation (EC) No 1907/2006 on the Registration, Evaluation, Authorization and Restriction of Chemicals 1 (abbreviated as "REACH") entered into force.

Dimension [mm]

PSE M16 with Pins

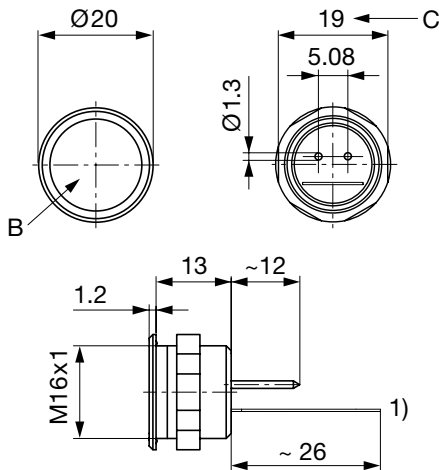

Legend:

1) = Type label

B = Actuating area

C = Width across flats

- Pins (with connection terminal 0701.9238)

Lettering:

- Either with/without lettering

- Position of the connections with respect to the position of the lettering is not defined

Dimension

PSE M16

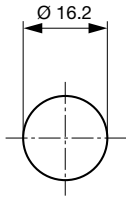

Drilling diagram

Lettering

The last three digits in the order number define the lettering:

001-076	Standard Lettering
101-	Customized Lettering

Lettering - Aluminium / Plastic Material

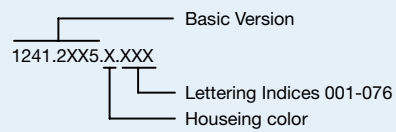



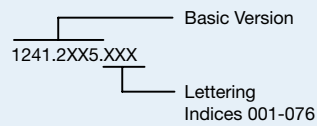

Lettering - Stainless Steel



Lettering Colour of Laser Lettering

Material	Lettering Colour	
Stainless Steel	black	Filled letters
Aluminum natural anodized	light grey	Filled letters (only after customer approval)
Aluminum coloured anodized	light grey	Filled letters

Order Index Lettering

Laser Marking			
001 = A	021 = U	041 = ÷	061 = EIN
002 = B	022 = V	042 = *	062 = AUS
003 = C	023 = W	043 = =	063 = AUF
004 = D	024 = X	044 = #	064 = AB
005 = E	025 = Y	045 = ↔	065 = ON
006 = F	026 = Z	046 = †	066 = OFF
007 = G	027 = 0	047 = →	067 = UP
008 = H	028 = 1	048 = ←	068 = DOWN
009 = I	029 = 2	049 = ↓	069 = HIGH
010 = J	030 = 3	050 = ↑	070 = LOW
011 = K	031 = 4	051 = %	071 = ON/OFF
012 = L	032 = 5	052 = √	072 = START
013 = M	033 = 6	053 = CTRL	073 = RESET
014 = N	034 = 7	054 = RETURN	074 = 
015 = O	035 = 8	055 = SHIFT	075 = 
016 = P	036 = 9	056 = LOCK	076 = 
017 = Q	037 = +	057 = STOP	077 = 
018 = R	038 = -	058 = ENTER	
019 = S	039 = .	059 = BACK	
020 = T	040 = x	060 = LINE	

All Variants

Mounting Diameter [mm]	Terminal	Housing Material	Colour of Housing	Config. Code	Order Number
16	Pins	Aluminum	gold	PSE M 16 EX EX	1241.2415.1
16	Pins	Aluminum	red	PSE M 16 EX EX	1241.2415.3
16	Pins	Aluminum	green	PSE M 16 EX EX	1241.2415.5
16	Pins	Aluminum	Alu natural	PSE M 16 EX EX	1241.2415.8

Annotation to the protection type:

- The explosion protected piezo switch element (PSE EX) has the function of a NO (normally open) switch.
- Permissible voltage and current of the PSE EX are limited, so that the PSE EX is intrinsically safe in accordance with EN60079-11 (see Technical Data).
- The use of the PSE EX is permitted in areas where the formation of explosive atmospheres caused by gases, fumes, mist or dust mixing with air occurs occasionally. The explosion protected PSE is classified according to EN 60079-0 in the device group II, category 2.

Attention:

- The permissible operating temperature is - 20°C to 60°C.- The approval will cease when the type label is removed.
- The switch has to be installed and used according to IEC/EN 60079-14 and IEC/EN 60079-25.

The listed item numbers represent a selection of the range of piezo switches. Other mounting diameters, materials, colors, connections and symbols are available on request. Special materials for use in salt and chlorinated environment on request.

The MOQ for standard laser lettering on standard variants is 10 pieces.

Availability for all products can be searched real-time:<https://www.schurter.com/en/Stock-Check/Stock-Check-SCHURTER>

Packaging unit 10 in cardboard box packed in air cushion bag with instruction manual



- Actuating elements in ESD safe packaging
- Screw nuts and sealing rings in a bag (enclosed in the box)

Accessories

Description



Connecting Terminal PSE
Connecting Terminal