



92x92x32 mm

San Ace 92 9G type

General Specifications

- Material Frame: Plastic (Flammability: UL 94V-0), Impeller: Plastic (Flammability: UL 94V-1)
- Expected life See the table below. (L10 life: 90% survival rate for continuous operation in free air at 60°C, rated voltage)
- Motor protection function Locked rotor burnout protection, Reverse polarity protection
For details, please refer to p. 529.
- Dielectric strength 50/60 Hz, 500 VAC, for 1 minute (between lead wire conductors and frame)
- Insulation resistance 10 MΩ or more with a 500 VDC megger (between lead wire conductors and frame)
- Sound pressure level (SPL) At 1 m away from the air inlet
- Storage temperature -30 to +70°C (Non-condensing)
- Lead wire ⊕Red ⊖Black or Blue (Sensor) Yellow
- Mass 170 g

Specifications

The models listed below **have ribs and pulse sensors**. For models without ribs, append "1" to the end of model numbers.

Model no.	Rated voltage [V]	Operating voltage range [V]	Rated current [A]	Rated input [W]	Rated speed [min ⁻¹]	Max. airflow [m ³ /min] [CFM]	Max. static pressure [Pa] [inchH ₂ O]	SPL [dB (A)]	Operating temperature [°C]	Expected life [h]		
9G0912A201	12	10.2 to 13.8	0.58	6.96	4300	2.5 88.3	115 0.462	44	-20 to +70	40000/60°C		
9G0912S201			0.38	4.56	3500	2.0 70.7	77 0.309	38				
9G0912H201			0.23	2.76	2850	1.59 56.2	51 0.205	32				
9G0912M201			0.13	1.56	2100	1.2 42.4	27 0.108	25				
9G0924A201	24	20.4 to 27.6	0.3	7.2	4300	2.5 88.3	115 0.462	44	-20 to +60		40000/60°C	
9G0924S201			0.19	4.56	3500	2.0 70.7	77 0.309	38				
9G0924H201			0.12	2.88	2850	1.59 56.2	51 0.205	32				
9G0924M201			0.08	1.92	2100	1.2 42.4	27 0.108	25				
9G0948A201	48	40.8 to 55.2	0.16	7.68	4300	2.5 88.3	115 0.462	44	-20 to +70			40000/60°C
9G0948S201			0.11	5.28	3500	2.0 70.7	77 0.309	38				
9G0948H201			0.08	3.84	2850	1.59 56.2	51 0.205	32				
9G0948M201			0.05	2.4	2100	1.2 42.4	27 0.108	25				

Other sensor specifications are available as options. Refer to the index (p. 549).

Airflow - Static Pressure Characteristics

9G0912A201 With pulse sensor

Operating voltage range

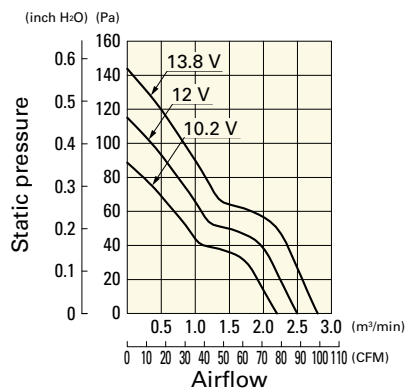

9G0912S201 With pulse sensor

Operating voltage range

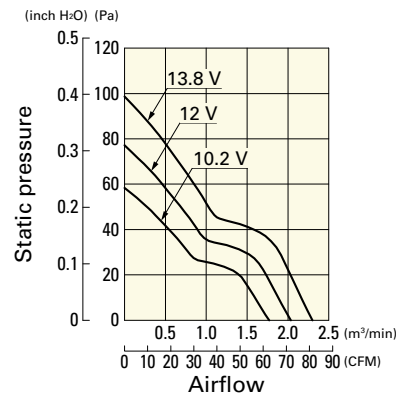

9G0912H201 With pulse sensor

Operating voltage range

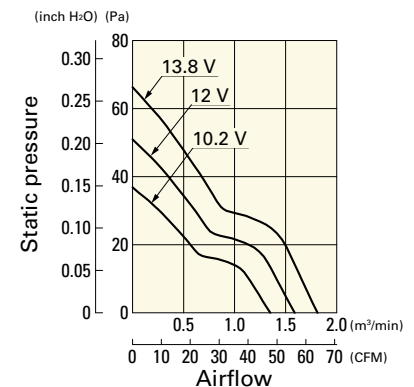

Airflow - Static Pressure Characteristics

9G0912M201 With pulse sensor

Operating voltage range

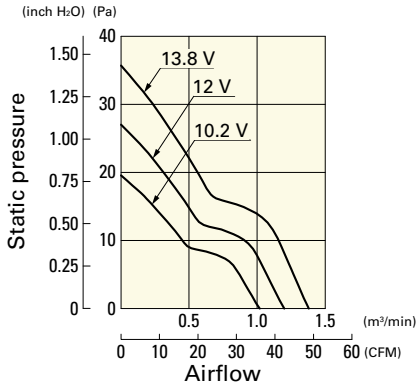

9G0924A201 With pulse sensor

Operating voltage range

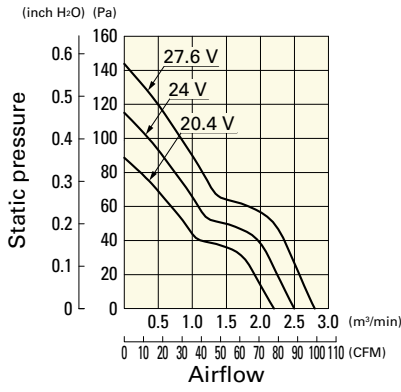

9G0924S201 With pulse sensor

Operating voltage range

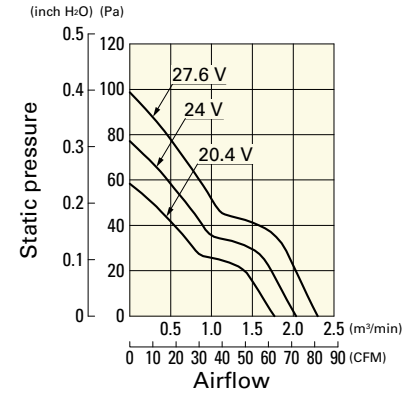

9G0924H201 With pulse sensor

Operating voltage range

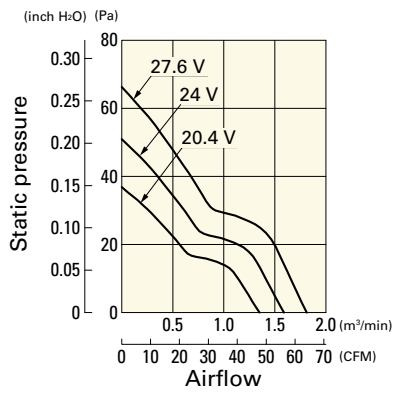

9G0924M201 With pulse sensor

Operating voltage range

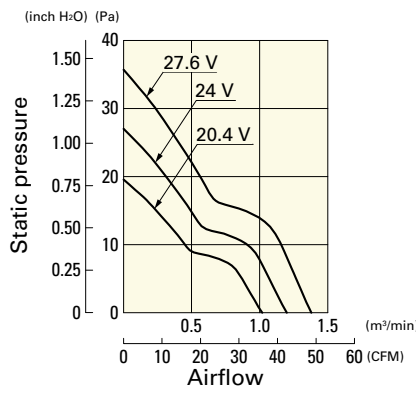

9G0948A201 With pulse sensor

Operating voltage range

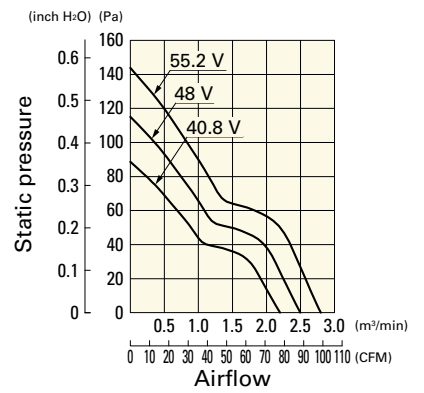

9G0948S201 With pulse sensor

Operating voltage range

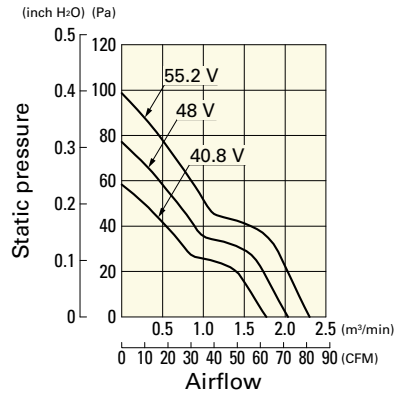

9G0948H201 With pulse sensor

Operating voltage range

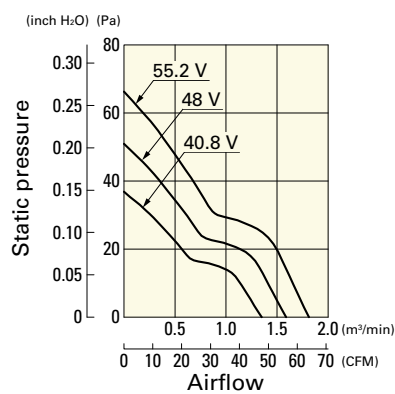

9G0948M201 With pulse sensor

Operating voltage range

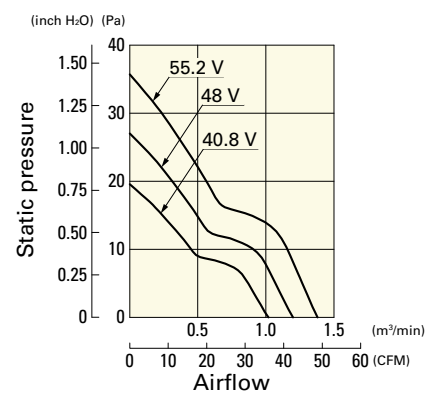

Dimensions (unit: mm) (With ribs)

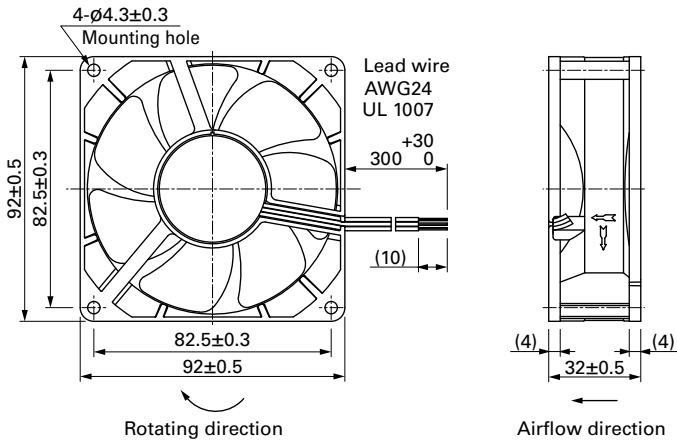

Reference Dimensions of Mounting Holes and Vent Opening (unit: mm)

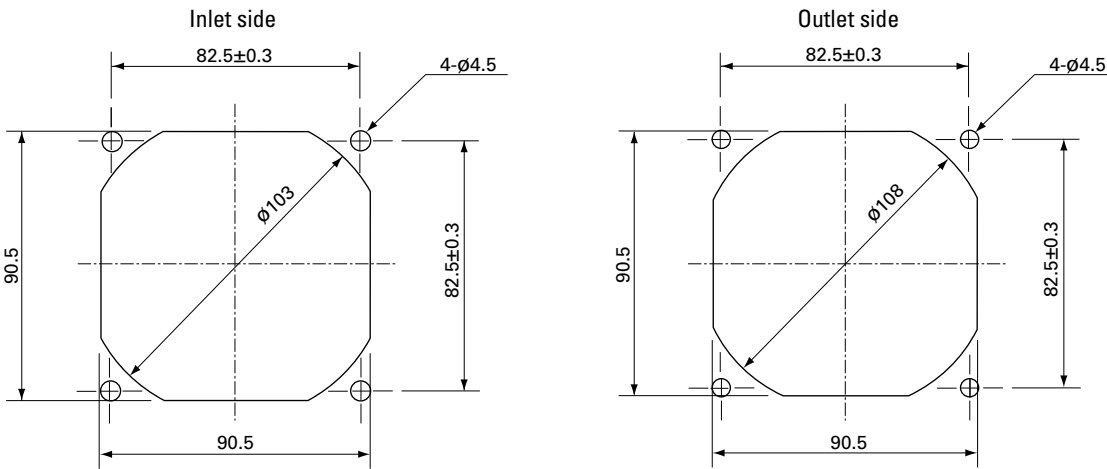

Options

Finger guards page: p. 513
 Model no.: 109-099C, 109-099E, 109-099H

Resin finger guards page: p. 520
 Model no.: 109-1001G

Resin filter kits page: p. 521
 Model no.: 109-1001F13 (13PPI), 109-1001F20 (20PPI),
 109-1001F30 (30PPI), 109-1001F40 (40PPI)