

PLEASE CHECK WWW.MOLEX.COM FOR LATEST PART INFORMATION

Part Number: [0015058218](#)
Status: **Active**
Description: 2.49mm (.098") Pitch Black Polyester IDT Cover, Feed-To, 21 Circuits

Documents:

[3D Model](#) [RoHS Certificate of Compliance \(PDF\)](#)
[Drawing \(PDF\)](#)

General

Product Family	Accessories
Series	7841
Component Type	Cover
Product Name	IDT (Insulation Displacement)

Physical

Circuits (Loaded)	21
Color - Resin	Black
Lock to Mating Part	No
Packaging Type	Bag

Material Info

Old Part Number	7841-B21B
-----------------	-----------

Reference - Drawing Numbers

Sales Drawing	SD-7841-****
---------------	--------------

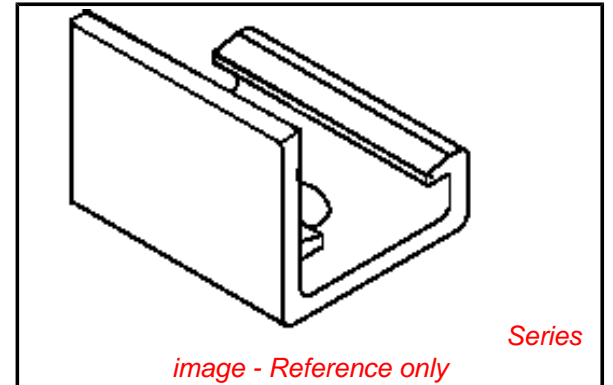

EU RoHS

**ELV and RoHS
Compliant**
**REACH SVHC
Not Reviewed**
**Low-Halogen Status
Not Reviewed**

China RoHS



**Need more information on product
environmental compliance?**

Email productcompliance@molex.com
 For a multiple part number RoHS Certificate of
 Compliance, [click here](#)

Please visit the [Contact Us](#) section for any
 non-product compliance questions.

Search Parts in this Series

7841Series