







Cylindrical 16-dia. Indicator

- Same basic design as the A16 Pushbutton Switch.

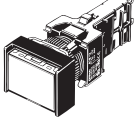

 Refer to *Safety Precautions for All Pushbutton Switches/ Indicators* and *Safety Precautions* on page 11.

List of Models

	Appearance	Model
Solder terminals	Rectangular 	M16-J
	Square 	M16-A
	Round 	M16-T
Voltage-reduction lighting		M16-□
Screw-less Clamp		M16-□

Button Colors

The button colors when the buttons are lit and when they are not lit are shown below. Use these colors as reference only. The actual colors may vary.

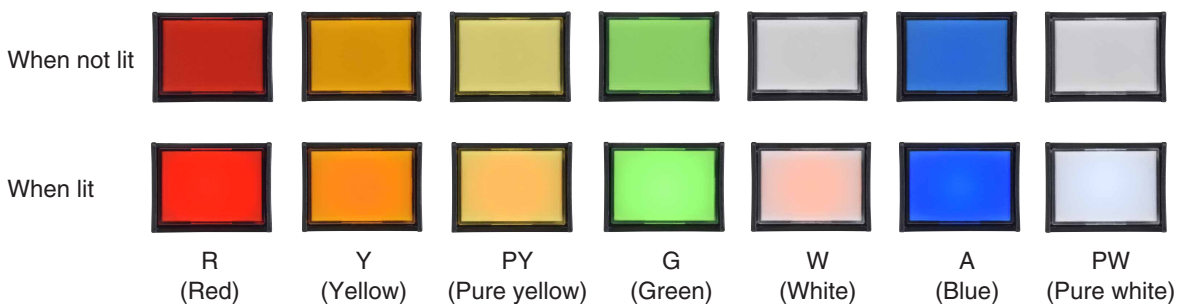

Model Number Structure

Model Number Legend The model numbers used to order sets of Units are illustrated below. One set comprises the Display, Case, Lamp, and Socket.

For information on combinations, refer to *Ordering Information* on the following pages.

(1)
(2)
(3)
(4)
(5)
M 1 6 5 - T R - 24D - S

(1) Degree of Protection

Symbol	Protection
No symbol	IP40
5	IP65 oil-resistant

(2) Shape of Display

Symbol	Shape
J	Rectangular
A	Square
T	Round

(3) Color of Display

Symbol	Color
R	Red
G	Green
Y	Yellow
PY	Pure yellow
W	White
PW	Pure white
A	Blue

• Color illuminated models are also available (see page 4).
• Order the parts separately.

(4) Light Source

Symbol	Type	Operating voltage	Rated voltage
5	Incandescent lamp	5 VAC/VDC	6 VAC/VDC
12		12 VAC/VDC	14 VAC/VDC
24		24 VAC/VDC	28 VAC/VDC
5D	LED	5 ±5% VDC	5 VDC
12D		12 ±5% VAC/VDC	12 VAC/VDC
24D		24 ±5% VAC/VDC	24 VAC/VDC

Voltage Reduction Unit (24-V Built-in LED)

Symbol	Type	Operating voltage	Rated voltage
T1	LED	100/110 VAC/VDC	110 VAC/VDC
T2		200/220 VAC/VDC	220 VAC/VDC

• Solder terminals are available only with 100-V models.
• Screw-less clamp connectors are used for 200-V models.

(5) Terminal Type

Symbol	Terminal type
No symbol	Solder terminals
S	Screw-less Clamp

Sets Select an Operation Unit Set (Operation Unit and Case) and a Socket Unit Set (Lamp and Socket Unit).

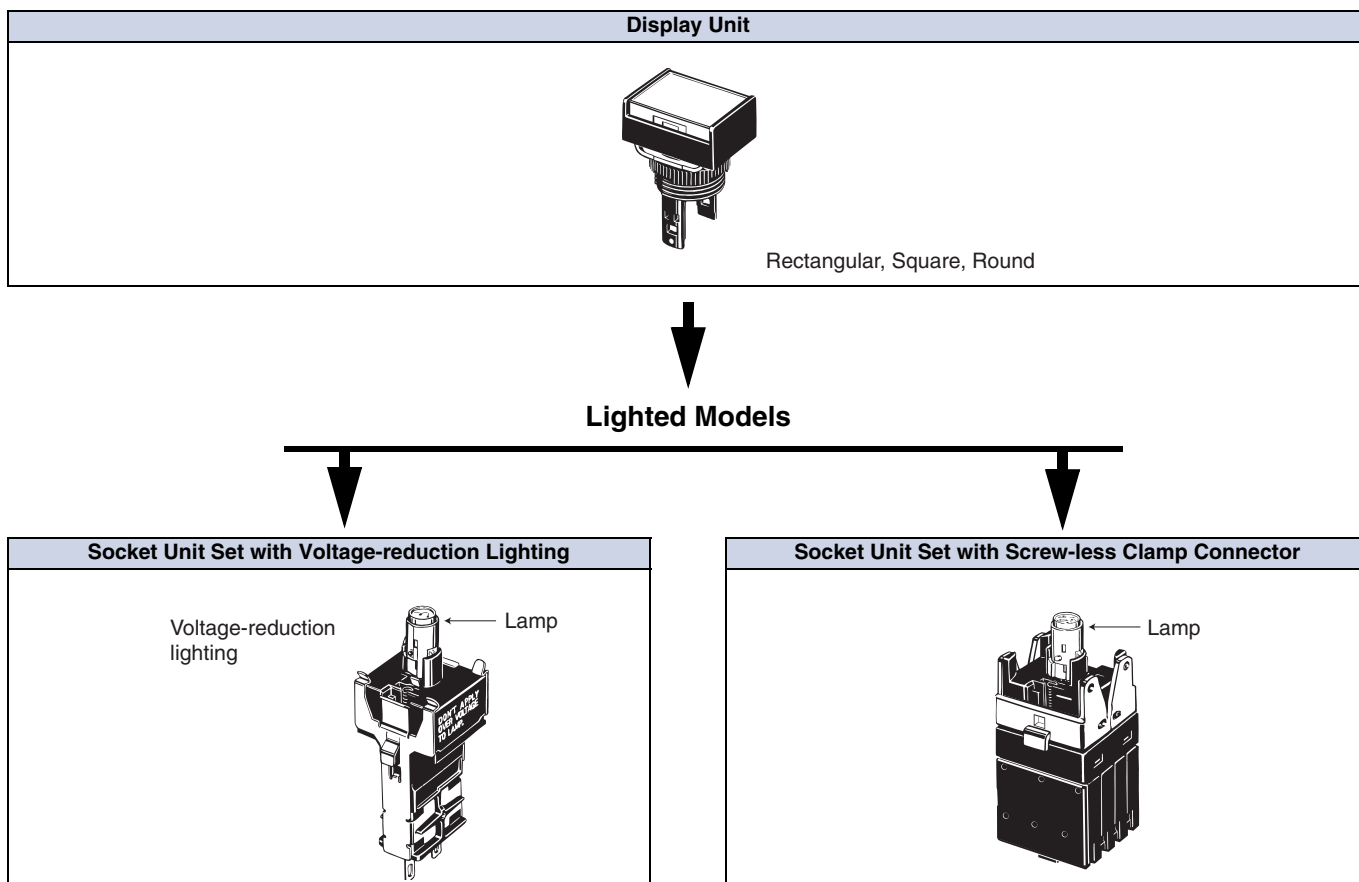

Ordering Information

Ordering as a Set The model numbers used to order sets of Units are given in the following tables. One set comprises the Display, Case, Lamp, and Socket.

M16□-J (Rectangular) Models

Solder Terminal Models

Appearance	Lighting	Degree of protection	IP40	IP65 oil-resistant	Display color symbol *
 Rectangular (M16-J)	LED without Voltage Reduction Unit	5 VDC	M16-J□-5D	M165-J□-5D	R: red Y: yellow G: green A: blue W: white PY: pure yellow PW: pure white
		12 VAC/VDC	M16-J□-12D	M165-J□-12D	
		24 VAC/VDC	M16-J□-24D	M165-J□-24D	
	Incandescent lamp	5 VAC/VDC	M16-J□-5	M165-J□-5	R: red Y: yellow G: green A: blue W: white PY: pure yellow
		12 VAC/VDC	M16-J□-12	M165-J□-12	
		24 VAC/VDC	M16-J□-24	M165-J□-24	

* Enter the desired color symbol into □ in the model number.

M16□-A (Square) Models

Solder Terminal Models

Appearance	Lighting	Degree of protection	IP40	IP65 oil-resistant	Display color symbol *
 Square (M16-A)	LED without Voltage Reduction Unit	5 VDC	M16-A□-5D	M165-A□-5D	R: red Y: yellow G: green A: blue W: white PY: pure yellow PW: pure white
		12 VAC/VDC	M16-A□-12D	M165-A□-12D	
		24 VAC/VDC	M16-A□-24D	M165-A□-24D	
	Incandescent lamp	5 VAC/VDC	M16-A□-5	M165-A□-5	R: red Y: yellow G: green A: blue W: white PY: pure yellow
		12 VAC/VDC	M16-A□-12	M165-A□-12	
		24 VAC/VDC	M16-A□-24	M165-A□-24	

* Enter the desired color symbol into □ in the model number.

M16□-T (Round) Models

Solder Terminal Models

Appearance	Lighting	Degree of protection	IP40	IP65 oil-resistant	Display color symbol *
 Round (M16-T)	LED without Voltage Reduction Unit	5 VDC	M16-T□-5D	M165-T□-5D	R: red Y: yellow G: green A: blue W: white PY: pure yellow PW: pure white
		12 VAC/VDC	M16-T□-12D	M165-T□-12D	
		24 VAC/VDC	M16-T□-24D	M165-T□-24D	
	Incandescent lamp	5 VAC/VDC	M16-T□-5	M165-T□-5	R: red Y: yellow G: green A: blue W: white PY: pure yellow
		12 VAC/VDC	M16-T□-12	M165-T□-12	
		24 VAC/VDC	M16-T□-24	M165-T□-24	

Note: Neon lamps are not available with models that are ordered as a set. They must be ordered individually if required.



* Enter the desired color symbol into □ in the model number.

Individual models: Refer to pages 4 to 7.
(The Display, Lamp, Case, and Switch can be ordered separately.)

- Accessories, replacements, and tools: Refer to the A16.
- Ratings and characteristics: Refer to the A16.
- Dimensions: Refer to pages 9 to 10.

Ordering Information

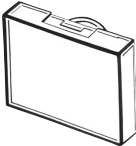
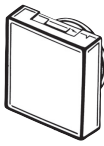
Ordering IndividuallyDisplays, Cases, Lamps, and Sockets can be ordered separately. Combinations that are not available as sets can be created using individual parts. Also, store the parts as spares for maintenance and repairs.

Display (Refer to page 6.)		
Rectangular 	Square 	Round 

Note: Use IP40 Displays in combination with IP40 Cases and use IP65 Displays in combination with IP65 Cases.
The Display has a legend plate built in.

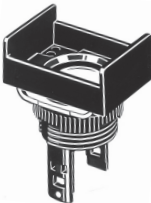

Case (Refer to page 7.)

Note: Display Units, which are combinations of Displays and Cases, are also available.



Lighted Models

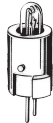

Lamp (Refer to page 7.)	
LED 	Incandescent Lamp 



Socket (Refer to page 7.)
Solder Terminals (Without Voltage Reduction Unit)

Note: Socket Units, which are combinations of Lamps and Sockets, are also available.

- For colored illumination, order the Display, Case, Lamp, and Socket Unit separately.

Ordering Information

Sets..... Sets that combined a Display and Cases are also available.

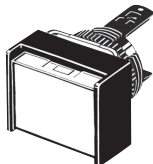
Display Set

Appearance	Classification		Model
	IP40	Rectangular (2-way guard)	A16-J□M
		Square (2-way guard)	A16-A□M
		Round (projecting model)	A16-T□M
	Oil-resistant IP65	Rectangular (2-way guard)	A165-J□M
		Square (2-way guard)	A165-A□M
		Round (projecting model)	A165-T□M

Insert one of the following symbols into the box in the model number.

Symbol	Color	Remarks
R	Red	LED and incandescent lamps
Y	Yellow	
PY	Pure yellow	
A	Blue	
W	White*	
GY	Green	LED only
G	Green	Incandescent only

* Use this pushbutton color if the illumination color of the LED is white or pure white.

Socket Unit Sets with Incandescent Lamps

Appearance	Classification		Model
	5 V	Solder terminals	M16-5
	12 V		M16-12
	24 V		M16-24

Socket Unit Sets with LEDs

Appearance	Classification	Model
	Solder terminals	M16-1-2

Socket Unit Sets with Voltage-reduction Lighting (Solder Terminals)

Appearance	Classification	Model
	100/110 VAC/VDC	M16-1-T1

Note: The LED has 24-VAC/VDC circuit built in.

Socket Unit Sets with Screw-less Clamp Connectors

Appearance	Classification		Model	
	Display	No voltage-reduction lighting	M16-1-2-S	
		Voltage-reduction lighting (See note.)	100/110 VAC/VDC	M16-1-T1-S
			200/220 VAC/VDC	M16-1-T2-S

Note: 1. The LED built into the 100-V model is 24 VAC/VDC.

2. The LED built into the 200-V model is high-intensity 24 VAC/VDC.

Insert symbols into the boxes with circled numbers.

1

Symbol	Color
R	Red
Y	Yellow
A	Blue
W	White
G	Green

2







Symbol	Type	Operating voltage
5D	LED	5 VDC
12D		12 VAC/VDC
24D		24 VAC/VDC

Ordering Information







Ordering IndividuallyDisplays, Cases, Lamps, and Sockets can be ordered separately. Combinations that are not available as sets can be created using individual parts. Also, store the parts as spares for maintenance and repairs.

Display

For LED-lighted Models

Sealing	IP40			IP65 oil-resistant		
	Rectangular	Square	Round	Rectangular	Square	Round
Appearance						
Color of Display						
Red	A16L-JR	A16L-AR	A16L-TR	A165L-JR	A165L-AR	A165L-TR
Yellow	A16L-JY	A16L-AY	A16L-TY	A165L-JY	A165L-AY	A165L-TY
Pure yellow	A16L-JPY	A16L-APY	A16L-TPY	A165L-JPY	A165L-APY	A165L-TPY
Green	A16L-JGY	A16L-AGY	A16L-TGY	A165L-JGY	A165L-AGY	A165L-TGY
White	A16L-JW	A16L-AW	A16L-TW	A165L-JW	A165L-AW	A165L-TW
Blue	A16L-JA	A16L-AA	A16L-TA	A165L-JA	A165L-AA	A165L-TA

Incandescent Lamps (With the exception of green, the Units are the same as for LEDs.)

Sealing	IP40			IP65 oil-resistant		
	Rectangular	Square	Round	Rectangular	Square	Round
Appearance						
Color of Display						
Red	A16L-JR	A16L-AR	A16L-TR	A165L-JR	A165L-AR	A165L-TR
Yellow	A16L-JY	A16L-AY	A16L-TY	A165L-JY	A165L-AY	A165L-TY
Pure yellow	A16L-JPY	A16L-APY	A16L-TPY	A165L-JPY	A165L-APY	A165L-TPY
Green	A16L-JG	A16L-AG	A16L-TG	A165L-JG	A165L-AG	A165L-TG
White	A16L-JW	A16L-AW	A16L-TW	A165L-JW	A165L-AW	A165L-TW
Blue	A16L-JA	A16L-AA	A16L-TA	A165L-JA	A165L-AA	A165L-TA

Ordering set combinations: Refer to page 3.

- Accessories, replacements, and tools: Refer to the A16.
- Ratings and characteristics: Refer to the A16.
- Dimensions: Refer to pages 9 to 10.

Ordering Information

Ordering Individually Displays, Cases, Lamps, and Sockets can be ordered separately. Combinations that are not available as sets can be created using individual parts. Also, store the parts as spares for maintenance and repairs.

Lamp LED

Color	Operating voltage	High intensity 		
		5 VDC	12 VAC/VDC	24 VAC/VDC
Red		A16-5DSR	A16-12DSR	A16-24DSR
Yellow		A16-5DSY	A16-12DSY	A16-24DSY
Green		A16-5DSG	A16-12DSG	A16-24DSG
White *		A16-5DSW	A16-12DSW	A16-24DSW
Blue		A16-5DA	A16-12DA	A16-24DA
Pure white		A16-5DPW	A16-12DPW	A16-24DPW

* Use the white LED when the required illumination color is white or pure yellow.

Incandescent Lamp

Appearance	Operating voltage	Model
	5 VAC/VDC	A16-5
	12 VAC/VDC	A16-12
	24 VAC/VDC	A16-24

Case

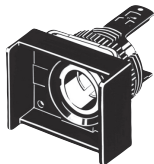
Appearance	Classification		Model number
	IP40	Rectangular	A16-CJM
		Square	A16-CAM
		Round	A16-CTM
	IP65 oil-resistant	Rectangular	A165-CJM
		Square	A165-CAM
		Round	A165-CTM

Socket

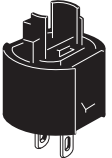
Appearance	Classification			Model number
 Solder terminals	Solder terminals			M16-0
	PCB terminals			M16-0P
	Screw-Less Clamp			M16-S
	Solder terminals	Voltage-reduction lighting	100 V	M16-T1
	Screw-less Clamp		100 V	M16-T1-S
			200 V	M16-T2-S

Ordering set combinations: Refer to page 3.

- Accessories, replacements, and tools: Refer to the A16.
- Ratings and characteristics: Refer to the A16.
- Dimensions: Refer to pages 9 to 10.

Specifications

Approved Standard Ratings

UL, cUL (File No. E76675)

LED: 24 VDC max.

Incandescent lamp: 24 VDC/VAC max.

Note: Certification has been obtained for the Socket Unit.

For detailed information on individual products that have received certification, consult your supplier.

Ratings

Ambient operating temperature	-10°C to 55°C (with no icing or condensation)
Ambient operating humidity	35% to 85%RH
Ambient storage temperature	-25°C to 65°C (with no icing or condensation)

Super-bright LED

Rated voltage	Rated current	Operating voltage	Built-in limiting resistance
5 VDC	8 mA	5 VDC \pm 5%	Red, yellow, white: 300 Ω Green, blue, pure white: 160 Ω
12 VAC/VDC		12 VAC/VDC \pm 5%	Red, yellow, white: 1 k Ω Green, blue, pure white: 910 Ω
24 VAC/VDC		24 VAC/VDC \pm 5%	2.4 k Ω

Incandescent Lamp

Rated voltage	Rated current	Operating voltage
6 VAC/VDC	60 mA	5 VAC/VDC
14 VAC/VDC	40 mA	12 VAC/VDC
28 VAC/VDC	24 mA	24 VAC/VDC

Characteristics

Screw-less Clamp

Item	Type	Screw-less Clamp			
Recommended wire size		0.5 mm ² twisted wire or 0.8 mm-dia. solid wire			
Usable wires and tensile strength	Twisted wire	0.3 mm ²	0.5 mm ²	0.75 mm ²	1.25 mm ²
	Solid wire	0.5 mm dia.	0.8 mm dia.	1.0 mm dia.	---
	Tensile strength	10 N	20 N	30 N	40 N
Length of exposed wire		10 \pm 1 mm			
Compliant standards		JIS C 2811 Terminal Blocks for Industrial Use			

Dimensions (Refer to the A16 for details of panel cutout dimensions.)

(Unit: mm)

Rectangular

M16□-J

Solder terminals

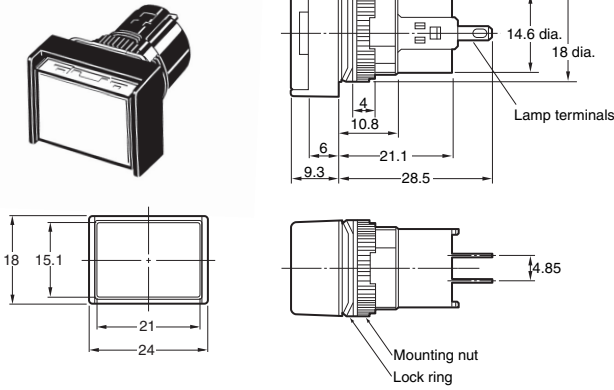

Square

M16□-A

Solder terminals

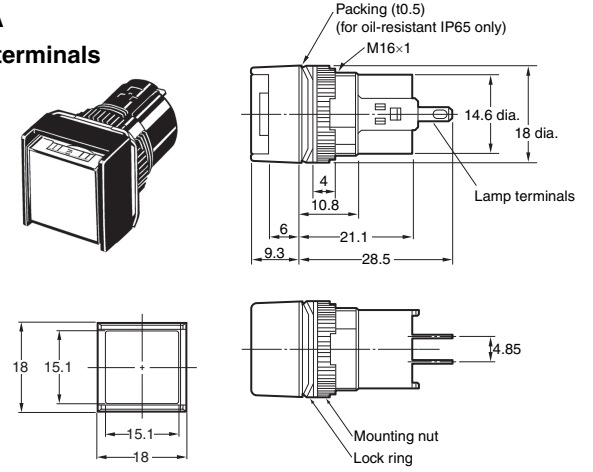

Round

M16□-T

Solder terminals

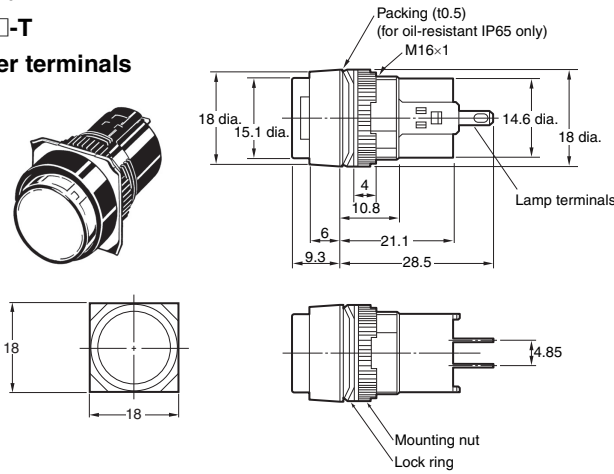

Terminal Hole Dimensions

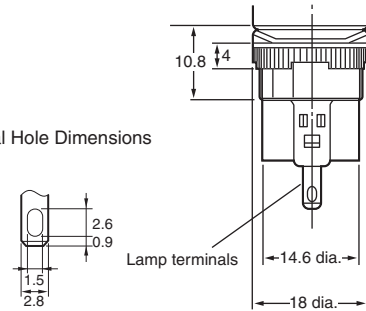

Dimensions

Rectangular

M16□-J□-T1

Voltage-reduction lighting,
solder terminals

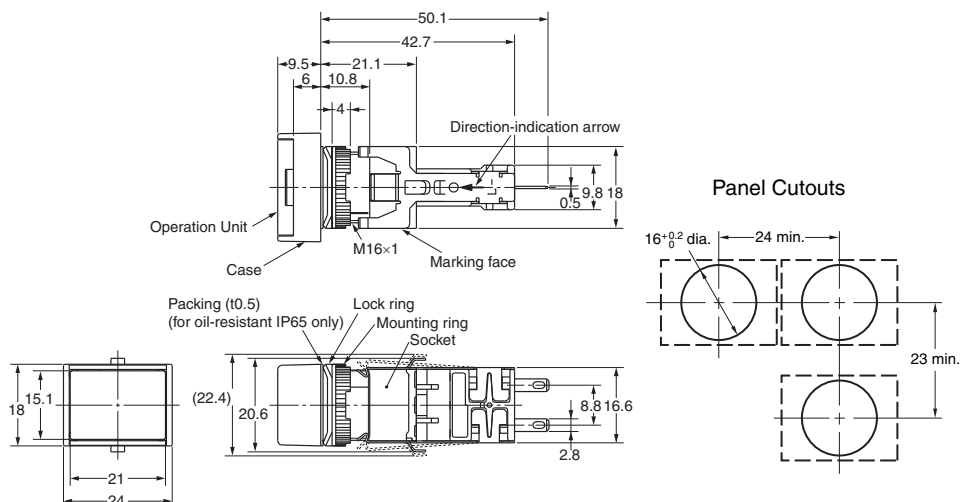
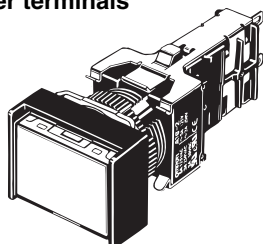

Rectangular

M16□-J□-S

Screw-less Clamp

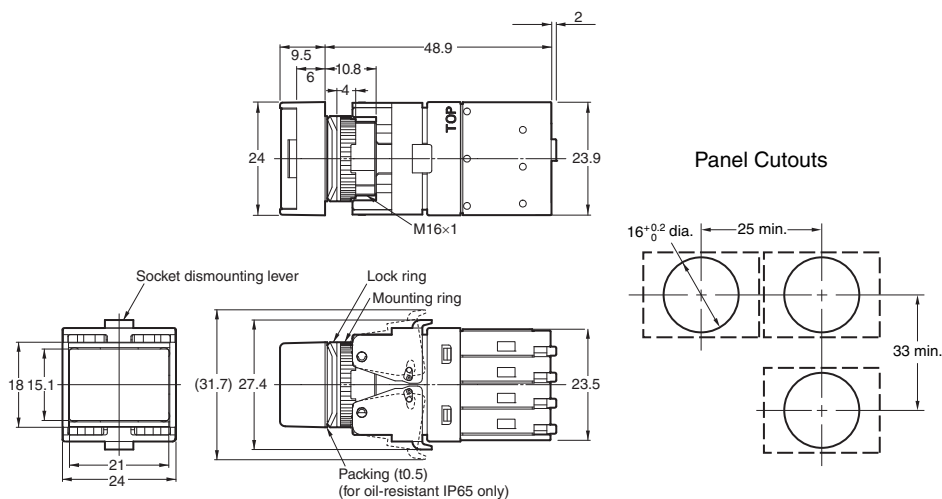
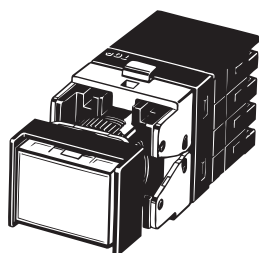

Dimensions

(All units are in millimeters unless otherwise indicated.)

Terminal Arrangement

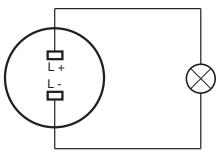
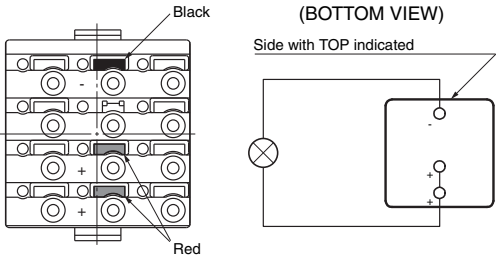
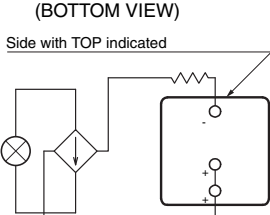
Solder Terminals	Screw-less Clamp	Voltage-reduction Lighting
<p>(BOTTOM VIEW)</p>  <p>The L+ is not shown on the Socket Unit.</p>	<p>(BOTTOM VIEW)</p> <p>Side with TOP indicated</p> 	<p>(BOTTOM VIEW)</p> <p>Side with TOP indicated</p>  <p>Models with voltage-reduction lighting have a circuit to reduce voltage built in.</p>

Accessories, Replacements, and Tools

The accessories, replacements, and tools are also used with the A16 Pushbutton Switch. Refer to the A16 datasheet.

Safety Precautions

Refer to *Safety Precautions for All Pushbutton Switches/Indicators* and *Safety Precautions for the A16*.

Precautions for Correct Use

Mounting

- When mounting the Case onto the Socket Unit, ensure that the orientation is correct. Perform mounting with the dimple on the Case and the TOP mark on the Socket Unit facing in the same direction.

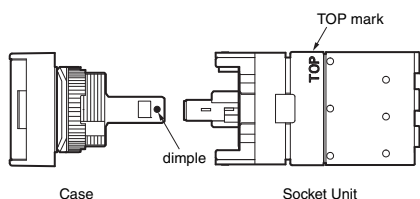

Wiring

- When using stranded wire, gather the ends of the strands together before wiring.
- When wiring, insert the wire until it comes into contact with something. After wiring is completed, pull on the wires to confirm that they are connected securely.
- After wiring, ensure that continuous pressure is not applied to the terminals.
- Refer to internal connections diagrams and confirm the terminal numbers before performing wiring.

Screw-less Clamps

Mounting Procedure

- Strip a length of 10 mm off the end of the wire (allowable range: 10 ± 1 mm).
- Bunch wire strands together and straighten them.
- Insert the wire into the insertion hole while pressing the release button at the side of the hole. (Using a precision screwdriver is recommended.)
- Let go of the release button to lock the wire into place.
- After locking, pull on the wire gently to confirm that it is securely locked.

Removing Procedure

- Remove wires by pulling them while pressing the release button.

Note: When reusing wires that have already been locked, cut off the end of the wire and strip the wire again before using.

Terms and Conditions Agreement

Read and understand this catalog.

Please read and understand this catalog before purchasing the products. Please consult your OMRON representative if you have any questions or comments.

Warranties.

(a) Exclusive Warranty. Omron's exclusive warranty is that the Products will be free from defects in materials and workmanship for a period of twelve months from the date of sale by Omron (or such other period expressed in writing by Omron). Omron disclaims all other warranties, express or implied.

(b) Limitations. OMRON MAKES NO WARRANTY OR REPRESENTATION, EXPRESS OR IMPLIED, ABOUT NON-INFRINGEMENT, MERCHANTABILITY OR FITNESS FOR A PARTICULAR PURPOSE OF THE PRODUCTS. BUYER ACKNOWLEDGES THAT IT ALONE HAS DETERMINED THAT THE PRODUCTS WILL SUITABLY MEET THE REQUIREMENTS OF THEIR INTENDED USE.

Omron further disclaims all warranties and responsibility of any type for claims or expenses based on infringement by the Products or otherwise of any intellectual property right. (c) Buyer Remedy. Omron's sole obligation hereunder shall be, at Omron's election, to (i) replace (in the form originally shipped with Buyer responsible for labor charges for removal or replacement thereof) the non-complying Product, (ii) repair the non-complying Product, or (iii) repay or credit Buyer an amount equal to the purchase price of the non-complying Product; provided that in no event shall Omron be responsible for warranty, repair, indemnity or any other claims or expenses regarding the Products unless Omron's analysis confirms that the Products were properly handled, stored, installed and maintained and not subject to contamination, abuse, misuse or inappropriate modification. Return of any Products by Buyer must be approved in writing by Omron before shipment. Omron Companies shall not be liable for the suitability or unsuitability or the results from the use of Products in combination with any electrical or electronic components, circuits, system assemblies or any other materials or substances or environments. Any advice, recommendations or information given orally or in writing, are not to be construed as an amendment or addition to the above warranty.

See <http://www.omron.com/global/> or contact your Omron representative for published information.

Limitation on Liability; Etc.

OMRON COMPANIES SHALL NOT BE LIABLE FOR SPECIAL, INDIRECT, INCIDENTAL, OR CONSEQUENTIAL DAMAGES, LOSS OF PROFITS OR PRODUCTION OR COMMERCIAL LOSS IN ANY WAY CONNECTED WITH THE PRODUCTS, WHETHER SUCH CLAIM IS BASED IN CONTRACT, WARRANTY, NEGLIGENCE OR STRICT LIABILITY.

Further, in no event shall liability of Omron Companies exceed the individual price of the Product on which liability is asserted.

Suitability of Use.

Omron Companies shall not be responsible for conformity with any standards, codes or regulations which apply to the combination of the Product in the Buyer's application or use of the Product. At Buyer's request, Omron will provide applicable third party certification documents identifying ratings and limitations of use which apply to the Product. This information by itself is not sufficient for a complete determination of the suitability of the Product in combination with the end product, machine, system, or other application or use. Buyer shall be solely responsible for determining appropriateness of the particular Product with respect to Buyer's application, product or system. Buyer shall take application responsibility in all cases.

NEVER USE THE PRODUCT FOR AN APPLICATION INVOLVING SERIOUS RISK TO LIFE OR PROPERTY OR IN LARGE QUANTITIES WITHOUT ENSURING THAT THE SYSTEM AS A WHOLE HAS BEEN DESIGNED TO ADDRESS THE RISKS, AND THAT THE OMRON PRODUCT(S) IS PROPERLY RATED AND INSTALLED FOR THE INTENDED USE WITHIN THE OVERALL EQUIPMENT OR SYSTEM.

Programmable Products.

Omron Companies shall not be responsible for the user's programming of a programmable Product, or any consequence thereof.

Performance Data.

Data presented in Omron Company websites, catalogs and other materials is provided as a guide for the user in determining suitability and does not constitute a warranty. It may represent the result of Omron's test conditions, and the user must correlate it to actual application requirements. Actual performance is subject to the Omron's Warranty and Limitations of Liability.

Change in Specifications.

Product specifications and accessories may be changed at any time based on improvements and other reasons. It is our practice to change part numbers when published ratings or features are changed, or when significant construction changes are made. However, some specifications of the Product may be changed without any notice. When in doubt, special part numbers may be assigned to fix or establish key specifications for your application. Please consult with your Omron's representative at any time to confirm actual specifications of purchased Product.

Errors and Omissions.

Information presented by Omron Companies has been checked and is believed to be accurate; however, no responsibility is assumed for clerical, typographical or proofreading errors or omissions.