

High Performance, Microminiature Circular Connectors

HR25 Series

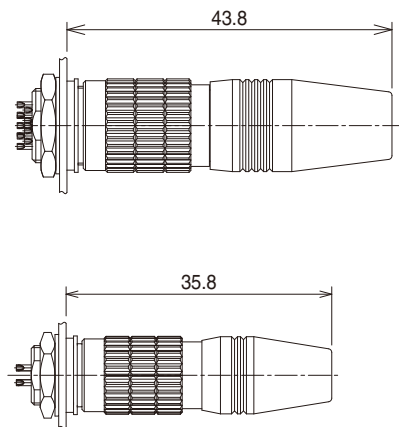

Mated dimensions



Diagrams of Connectors in Combination

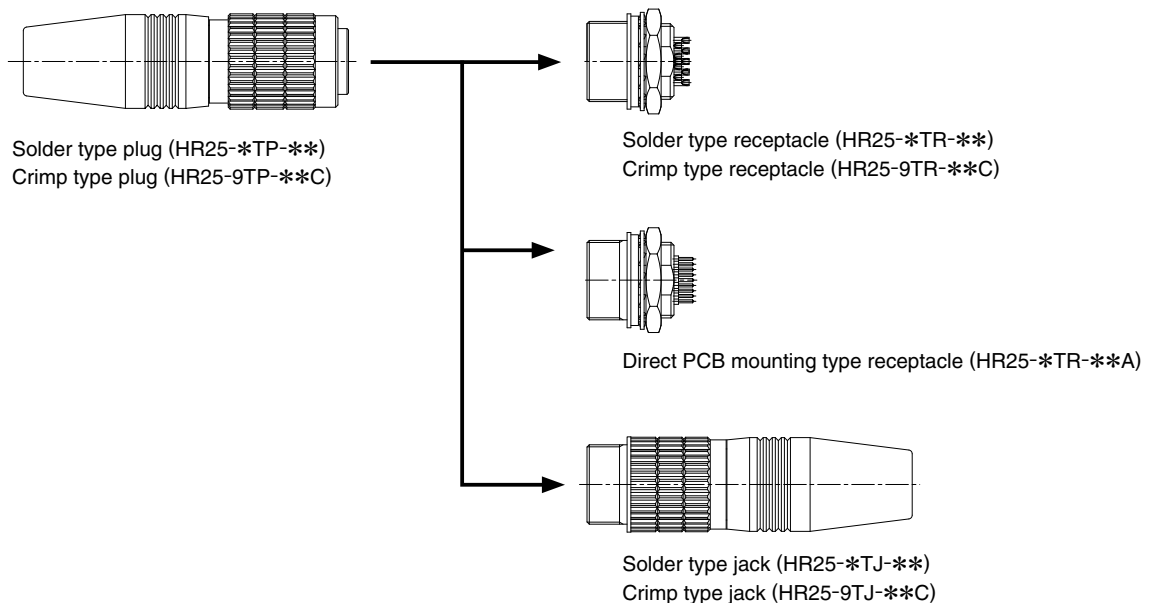

Features

1. Small, high density design

Maximum plug outer diameter : 4, 6, 8 contacts : $\phi 10.5$

12, 16, 20 contacts : $\phi 12.5$

Designed with Hirose technology to be small, compact connectors with a low profile.

2. Wide range of product variations

Number of contacts : 4, 6, 8, 12, 16, 20

Connector styles : Plug, jack, receptacle

Termination style : Solder, crimp (Additionally, a direct PCB mounting style is also available for receptacles.)

Contact gender : Plug, receptacle, and jack connectors are available configured either way with male or female contacts.

3. Shielded design

The connector's metal shell design is an optimal choice for devices that require EMI shielding.

4. RoHS compliant

All materials and substances used to produce this product comply with RoHS standards.

Product Specifications

Ratings	Rated current	1A	Operating temperature range	-25°C to +85°C
	Rated voltage	30V AC, 42V DC	Storage temperature range	-10°C to +60°C

Items	Specifications	Conditions
1.Contact resistance	30 mΩ min.	Measured at DC 1A
2.Insulation resistance	1,000 MΩ min.	Measured at DC 100 V
3.Withstanding Voltage	No flashover or dielectric breakdown.	AC 100 V for one minute
4.Vibration resistance	No electrical discontinuity for 10 μs or greater.	10 to 55 Hz/cycle, amplitude: 0.75 mm, 3 axis directions, 2 hours each direction
5.Shock resistance	No electrical discontinuity for 10 μs or greater.	Acceleration: 490 ms ² , duration: 11 ms, 3 axis directions, 3 cycles each direction.
6.Mating Cycles	Contact resistance: 50 mΩ max.	1,000 times
7.Temperature cycle	Insulation resistance: 1,000 MΩ min.	-55°C: 30 minutes → Normal temperature: 10 to 15 minutes → 85°C: 30 minutes → Normal temperature: 10 to 15minutes, left for 5 cycles
8.Moisture resistance	Insulation resistance: 5 MΩ min. (at high humidity) 50 MΩ min (when dry)	Temperature: 40°C, relative humidity: 90 to 95%, left for 96 hours

Material

Item	Material	Finish	Remarks
Plug/jack	Plated shell	Zinc alloy	Nickel plated
	Insulator	PPS resin	UL94V-0
	Gasket, boot	Ethylene-propylene rubber	
	Contact	Phosphor bronze	Gold plated
Receptacle	Plated shell	Zinc ally	Nickel plated
	Insulator	PPS resin	UL94V-0
	Contact	Phosphor bronze	Gold plated
	Gasket	Ethylene-propylene rubber	

Product Number Structure

HR25 - 9 T P - 20 P C ()**

① ② ③ ④ ⑤ ⑥ ⑦ ⑧

① Model name : HR25 Series
② Shell size : The shell size is the outer diameter of the mating end of the plug.
③ Locking mechanism T : Screw-lock
④ Connector type P : Plug R : Receptacle J : Jack
⑤ Number of contacts
⑥ Contact type: S : Female contact P : Male contact
⑦ Contact termination method: None : Solder termination C : Crimp termination A : PCB dip termination
⑧ Other specifications: A two-digit number is added to indicate other specifications than ① to ⑦ shown above.

■ Plug

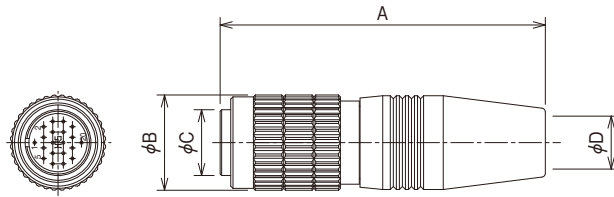

● Solder type

Unit: mm

Part No.	HRS No.	No. of contacts	A	φB	φC	φD	Weight
HR25-7TP-4P(72)	125-0001-8 72	4	35	10.5	6.7	5	8g
HR25-7TP-4S(72)	125-0002-0 72						
HR25-7TP-6P(72)	125-0003-3 72	6					
HR25-7TP-6S(72)	125-0004-6 72						
HR25-7TP-8P(72)	125-0005-9 72	8					
HR25-7TP-8S(72)	125-0006-1 72						
HR25-9TP-12P(72)	125-0101-2 72	12	43	12.5	8.7	7	13g
HR25-9TP-12S(72)	125-0102-5 72						
HR25-9TP-16P(74)	125-0103-8 74	16					
HR25-9TP-16S(73)	125-0104-0 73						
HR25-9TP-20P(72)	125-0105-3 72	20					
HR25-9TP-20S(73)	125-0106-6 73						

● Crimp type

Unit: mm

Part No.	HRS No.	No. of contacts	A	φB	φC	φD	Weight
HR25-9TP-12PC(72)	125-0401-6 72	12	43	12.5	8.7	7	12g
HR25-9TP-12SC(72)	125-0402-9 72						
HR25-9TP-16PC(72)	125-0403-1 72	16					
HR25-9TP-16SC(72)	125-0404-4 72						
HR25-9TP-20PC(72)	125-0405-7 72	20					
HR25-9TP-20SC(72)	125-0406-0 72						

■ Receptacle

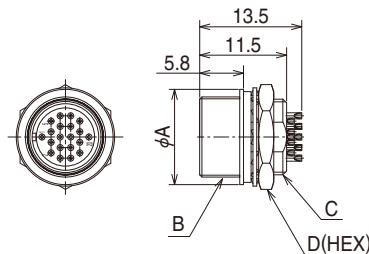

● Solder type

Unit: mm

Part No.	HRS No.	No. of contacts	φA	B	C	D	Weight
HR25-9TR-4S(73)	125-0007-4 73	4	10.6	M8.5×0.5	M8×0.5	10	3g
HR25-9TR-4P(73)	125-0008-7 73						
HR25-9TR-6S(73)	125-0009-0 73	6					
HR25-9TR-6P(73)	125-0010-9 73						
HR25-9TR-8S(73)	125-0011-1 73	8					
HR25-9TR-8P(73)	125-0012-4 73						
HR25-9TR-12S(71)	125-0107-9 71	12	12.6	M10.5×0.5	M10×0.75	12	4g
HR25-9TR-12P(71)	125-0108-1 71						
HR25-9TR-16S(71)	125-0109-4 71	16					
HR25-9TR-16P(71)	125-0110-3 71						
HR25-9TR-20S(71)	125-0111-6 71	20					
HR25-9TR-20P(71)	125-0112-9 71						

● Crimp type

Unit: mm

Part No.	HRS No.	No. of contacts	A	Weight
HR25-9TR-12SC(71)	125-0407-2 71	12	11.5	3g
HR25-9TR-12PC(71)	125-0408-5 71		13	
HR25-9TR-16SC(71)	125-0409-8 71	16	11.5	
HR25-9TR-16PC(71)	125-0410-7 71		13	
HR25-9TR-20SC(71)	125-0411-0 71	20	11.5	
HR25-9TR-20PC(71)	125-0412-2 71		13	

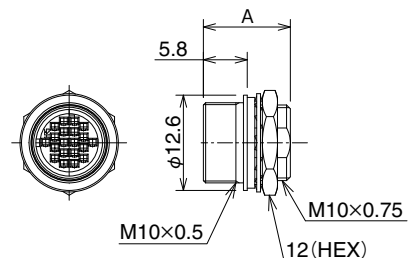

■ Receptacle

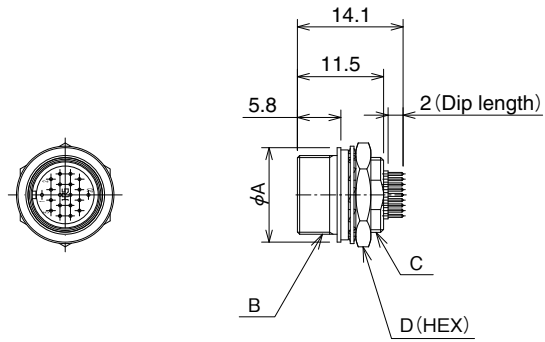

● Direct PCB mounting type

Unit: mm

Part No.	HRS No.	No. of contacts	φA	B	C	D	Weight
HR25-7TR-4SA(73)	125-0019-3 73	4	10.6	M8.5×0.5	M8×0.5	10	3g
HR25-7TR-4PA(73)	125-0020-2 73						
HR25-7TR-6SA(73)	125-0021-5 73	6					
HR25-7TR-6PA(73)	125-0022-8 73						
HR25-7TR-8SA(73)	125-0023-0 73	8					
HR25-7TR-8PA(73)	125-0024-3 73						
HR25-9TR-12SA(71)	125-0119-8 71	12	12.6	M10.5×0.5	M10×0.75	12	4g
HR25-9TR-12PA(71)	125-0120-7 71						
HR25-9TR-16SA(71)	125-0121-0 71	16					
HR25-9TR-16PA(71)	125-0122-2 71						
HR25-9TR-20SA(71)	125-0123-5 71	20					
HR25-9TR-20PA(71)	125-0124-8 71						

■ Jack

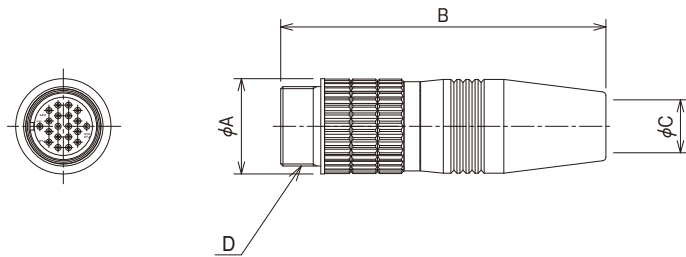

● Solder type

Unit: mm

Part No.	HRS No.	No. of contacts	φA	B	φC	D	Weight
HR25-7TJ-4S(72)	125-0013-7 72	4	10.6	35	5	M8.5×0.5	8g
HR25-7TJ-4P(72)	125-0014-0 72						
HR25-7TJ-6S(72)	125-0015-2 72	6					
HR25-7TJ-6P(72)	125-0016-5 72						
HR25-7TJ-8S(72)	125-0017-8 72	8					
HR25-7TJ-8P(72)	125-0018-0 72						
HR25-9TJ-12S(72)	125-0113-1 72	12	12.6	43	7	M10.5×0.5	12g
HR25-9TJ-12P(72)	125-0114-4 72						
HR25-9TJ-16S(72)	125-0115-7 72	16					
HR25-9TJ-16P(72)	125-0116-0 72						
HR25-9TJ-20S(73)	125-0117-2 73	20					
HR25-9TJ-20P(72)	125-0118-5 72						

● Crimp type

Unit: mm

Part No.	HRS No.	No. of contacts	φA	B	φC	D	Weight
HR25-9TJ-12SC(72)	125-0413-5 72	12	12.6	43	7	M10.5×0.5	12g
HR25-9TJ-12PC(72)	125-0414-8 72						
HR25-9TJ-16SC(72)	125-0415-0 72	16					
HR25-9TJ-16PC(72)	125-0416-3 72						
HR25-9TJ-20SC(72)	125-0417-6 72	20					
HR25-9TJ-20PC(72)	125-0418-9 72						

■ Crimp-style contacts

● Male Contacts

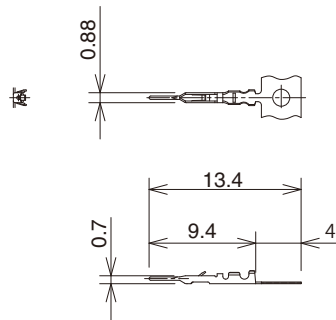

● Female Contacts

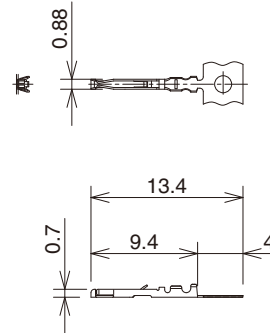

Type	Part No.	HRS No.	Suitable Wire
Loose contacts	HR25-PC-111	125-0419-1	AWG#30
Reel contacts	HR25-PC-211	125-0420-0	

Note: 1. Please use wire with a outer jacket diameter of 0.71mm or less.
 2. Loose contacts come in packages of 100 pcs.
 Reel contacts come in reels of 10,000 pcs.

Type	Part No.	HRS No.	Suitable Wire
Loose contacts	HR25-SC-111	125-0421-3	AWG#30
Reel contacts	HR25-SC-211	125-0422-6	

Note: 1. Please use wire with a outer jacket diameter of 0.71mm or less.
 2. Loose contacts come in packages of 100 pcs.
 Reel contacts come in reels of 10,000 pcs.

◆ Applicable Tools

Type	Item	Part No.	HRS No.	Applicable Contacts	Applicable Wire and Applicable Cable Diameter
Manual	Manual crimping tool	HR25-TA3032HC	150-0207-3	HR25-PC-111 HR25-SC-111	AWG#30
Auto	Auto crimping machine body	CM-105	901-0005-4	-	-
	Applicator	AP105-HR25-1	901-2040-6	HR25-PC-211 HR25-SC-211	AWG#30
	Cable crimping tool	HR10A-TC-02	150-0041-2	-	$\phi 5$ 、 $\phi 7$
	Extractor	HR25-TP	150-0091-0	-	-

◆ Assembly Tools

Use of the following assembly tools will simplify the process of disassembling and assembling the connectors for the cable assembly.

Part No.	HRS No.	Suitable Connectors and Uses
HR25-7TP-T01	150-0082-0	For HR25-7TP wiring and P shell unit tightening
HR25-9TP-T01	150-0080-4	For HR25-9TP wiring and P shell unit tightening
HR25-7TJ-T01	150-0089-9	For HR25-7TJ wiring and J shell unit tightening
HR25-9TJ-T01	150-0090-8	For HR25-9TJ wiring and J shell unit tightening

◆ Cable Assembly Procedures

- The outline of wiring work for this diagram uses the soldered type as an example.
The jack side is also based on the work outline of the plug; however, the receptacle side does not require a special work outline and has been omitted because of this.

● Construction Diagram

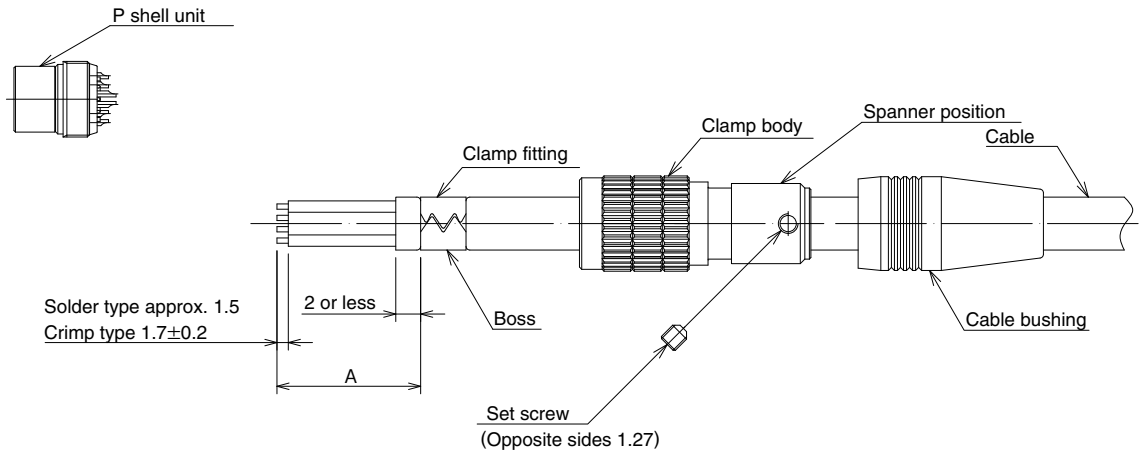

Table 1

Shell size	Soldered type A dimensions	Crimp type A dimensions	Spanner spacing	Tightening torque
7	10mm	-	8mm	1N · m
9	19mm	15mm	10mm	1N · m

○ Work Operation Procedures

1. With regard to cables, the wire to be used should have a conductor with a nominal cross-sectional area of 0.08 mm² (AWG#28) or less in a finished form suited to each size.
2. First pass the cable bushing and the plug body in order over the cable, then cut the end at the dimensions indicated in the above diagram.
3. Mount the P shell unit in the wiring jig and perform the solder wiring.
4. Use the cable crimping jig (HR10A-TC-02) to fix the clamp fitting to the cable.
5. After performing the wiring, tighten the plug body to the screw portion of the P shell unit using the specified torque (in the above table).
6. Tighten the set screw so that the tip of the set screw falls into one of the two bosses of the clamp fitting. Note that the tightening torque of the set screw is from 0.3 to 0.4 Nm.
7. Put the cable bushing over the plug body and complete the work.
Note that the use of paint lock (e.g., Locktight 263 manufactured by HENKEL JAPAN LTD.) is recommended on the screw portion to prevent loosening of the P shell unit.

The aforementioned work procedure is for the soldered type. In the case of the crimp-style type, Steps 1 and 3 are changed as follows:

1. With regard to cables, the wire to be used should have a conductor with a nominal cross-sectional area of 0.05 mm² (AWG#30) in a finished form suited to each size.
3. Crimp a suitable crimp terminal to the conductor portion of the cable, then fit into the housing of the P shell unit.

Mounting Hole Dimensions Diagram

Mounting hole dimensions are indicated as viewed from the engagement side.

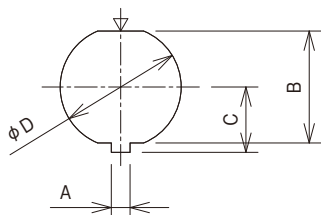

Lock System	Screw Lock Type	
Shell Size	Size 7	Size 9
Diagram Symbol		
A	1.55 ^{+0.05} / ₀	1.55 ^{+0.05} / ₀
B	7.25 ^{+0.03} / _{-0.02}	9.25 ^{+0.03} / _{-0.02}
C	4.4 ^{+0.1} / ₀	5.4 ^{+0.1} / ₀
D	8 ^{+0.05} / ₀	10 ^{+0.05} / ₀
Mounting Panel Thickness	0.7 ~ 2	0.7 ~ 2

Note: The ∇ mark indicates the engagement guide key position.

Receptacle Dip Post Configuration Dimensions

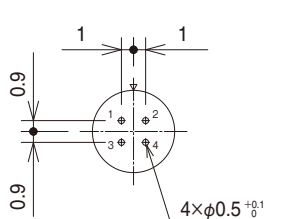

Size 7, 4 conductors

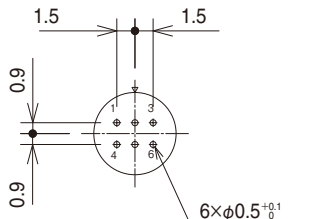

Size 7, 6 conductors

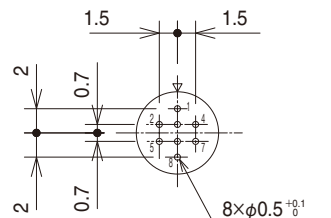

Size 7, 8 conductors

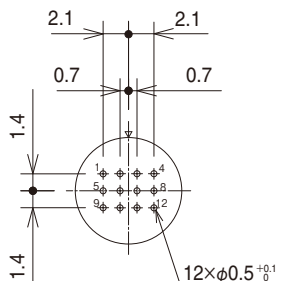

Size 9, 12 conductors

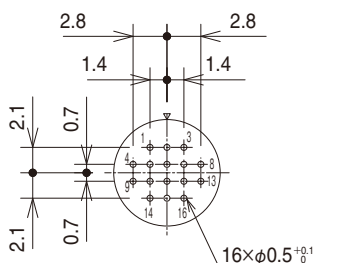

Size 9, 16 conductors

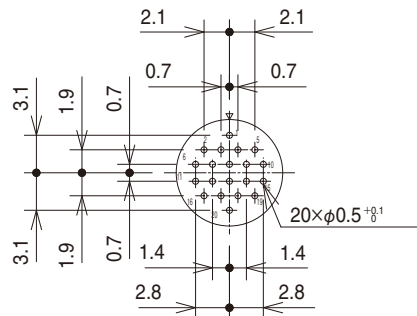

Size 9, 20 conductors

Note:

1. The above diagrams are viewed from the engagement side of the socket insert (i.e., the wiring side of the pin insert).
2. The ∇ mark of the above diagrams indicates the engagement guide key position.
3. A tolerance of ± 0.05 is recommended for dimensions without indication.

◆ Contact Configuration and Basic Specifications

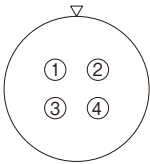
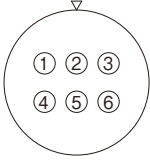
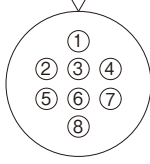
Shell size	Size 7		
Contact configuration			
Number of contacts	4	6	8
Withstand voltage	100V AC for 1 minute		
Current capacity	1 A		
Insulation resistance	1,000 MΩ or greater		
Contact resistance	30 mΩ		
Solder pot inside diameter	0.5 mm dia.		

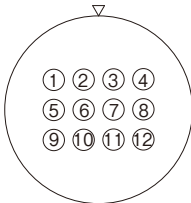
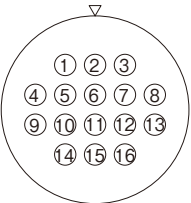
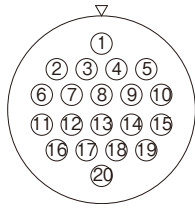
Shell size	Size 9		
Contact configuration			
Number of contacts	12	16	20
Withstand voltage	100V AC for 1 minute		
Current capacity	1 A		
Insulation resistance	1,000 MΩ or greater		
Contact resistance	30 mΩ		
Solder pot inside diameter	0.5 mm dia.		

Note:

1. The above diagrams are viewed from the engagement side of the socket insert (i.e., the wiring side of the pin insert).
2. The ▽ mark of the above diagrams indicates the engagement guide key position.
3. The withstand voltage indicates the test voltage value. For regular use the voltage used should be less than 30 V AC or 42 V DC.
4. The current capacity of the crimp terminals indicates the value when using wire of AWG#30.
5. The insulation resistance indicates a value when measured at 100 V DC.

◆ Precautions

1. Switch off the power of the circuit before disconnecting or plugging-in the connectors.
2. Use connectors with socket contacts at the power side of the circuit.
3. Make sure that the coupling is in completely cocked position.
4. Cable clamping, cable rotation, and other forces may vary with the cable construction. Please make sure that your cable is suitable for use with these connectors before usage and production.



HIROSE ELECTRIC CO.,LTD.

2-6-3,Nakagawa Chuoh,Tsuzuki-Ku,Yokohama-Shi 224-8540,JAPAN
 TEL: +81-45-620-3526 Fax: +81-45-591-3726
<http://www.hirose.com>
<http://www.hirose-connectors.com>