

PLEASE CHECK WWW.MOLEX.COM FOR LATEST PART INFORMATION

Part Number: [0923150425](#)
Status: **Active**
Overview: [Picoflex Ribbon-Cable Connectors](#)
Description: Picoflex PF-50 IDT-to-IDT, 4 Circuits, 0.25m Length

Documents:

[3D Model](#) [Product Specification PS-99020-0011 \(PDF\)](#)
[Drawing \(PDF\)](#) [RoHS Certificate of Compliance \(PDF\)](#)

General

Product Family	Cable Assemblies
Series	92315
Application Tooling Part Link	62100-6000
Application Tooling Part Link	62100-6010
Assembly Configuration	Dual Ended Connectors
Connector to Connector	Picoflex IDT-to-IDT
Overview	Picoflex Ribbon-Cable Connectors
Product Name	Picoflex
UPC	800754779654

Physical

Cable Length	0.25m
Circuits (Loaded)	4
Color - Resin	Natural
Gender	Female-Female
Lock to Mating Part	None
Material - Metal	Phosphor Bronze
Material - Plating Mating	Tin
Material - Plating Termination	Tin
Material - Resin	Polyester
Net Weight	2.270/g
Packaging Type	Bag
Pitch - Mating Interface	1.27mm
Plating min - Mating	2.032µm
Plating min - Termination	2.032µm
Single Ended	No
Termination Interface: Style	IDT or Pierce
Waterproof / Dustproof	No
Wire Insulation Diameter	N/A
Wire Size AWG	28
Wire/Cable Type	PVC, Ribbon Cable

Electrical

Current - Maximum per Contact	1.2A
Shielded	No
Voltage - Maximum	250V

Material Info

Reference - Drawing Numbers

Product Specification	PS-99020-0011
Sales Drawing	SD-92315-001

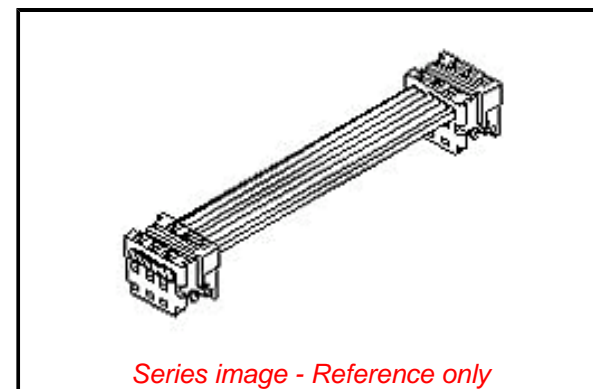

Series image - Reference only

EU ELV

Not Relevant

EU RoHS

Compliant

REACH SVHC

Not Contained Per
-ED/01/2018 (15
January 2018)

Halogen-Free

Status

Not Low-Halogen

Need more information on product environmental compliance?

Email productcompliance@molex.com
Please visit the [Contact Us](#) section for any non-product compliance questions.

China ROHS	Green Image
ELV	Not Relevant
RoHS Phthalates	Not Contained

Search Parts in this Series

[92315 Series](#)

Mates With

Picoflex PF-50 Header [90325](#) , [90800](#) , [90779](#) , [90715](#) , [90814](#)