

PLEASE CHECK WWW.MOLEX.COM FOR LATEST PART INFORMATION

Part Number: [51052-0900](#)
Status: **Active**
Description: 2.50mm Pitch Cable Holder, Vertical, for Ribbon Cable, 9 Circuits

Documents:

[3D Model](#) [Product Specification PS-51052-002 \(PDF\)](#)
[Drawing \(PDF\)](#) [RoHS Certificate of Compliance \(PDF\)](#)
[Product Specification PS-51052-001 \(PDF\)](#)

General

Product Family Ribbon Cable / Wire Trap Connectors
 Series [51052](#)
 Component Type One Piece
 Glow-Wire Compliant No
 Product Name Board-In, Cable Holder
 UPC 800753574526

Physical

Circuits (Loaded) 9
 Color - Resin Natural
 Entry Angle Vertical
 Lock to Mating Part None
 Material - Plating Mating N/A
 Material - Resin Nylon
 Net Weight 306.000/mg
 Number of Rows 1
 PCB Retention Yes
 PCB Thickness - Recommended 1.60mm
 Packaging Type Bag
 Pitch - Mating Interface 2.50mm
 Pitch - Termination Interface 2.50mm
 Polarized to Mating Part N/A
 Polarized to PCB No
 Stackable No
 Surface Mount Compatible (SMC) No
 Temperature Range - Operating -40°C to +105°C
 Wire Insulation Diameter 1.70mm max.
 Wire Size AWG 24, 26
 Wire/Cable Type Ribbon Cable

Electrical

Current - Maximum per Contact N/A
 Voltage - Maximum N/A

Material Info

Reference - Drawing Numbers

Product Specification PS-51052-001, PS-51052-002, RPS-51052-003
 Sales Drawing SD-51052-**00, SD-51052-001

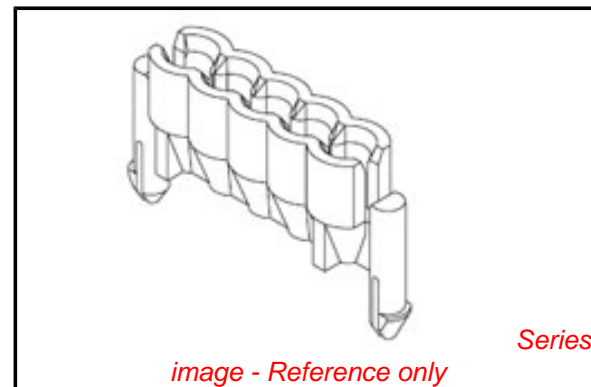

EU RoHS

ELV and RoHS Compliant
REACH SVHC Contains SVHC: No
Low-Halogen Status Low-Halogen

China RoHS



Need more information on product environmental compliance?

Email productcompliance@molex.com
 For a multiple part number RoHS Certificate of Compliance, [click here](#)

Please visit the [Contact Us](#) section for any non-product compliance questions.

Search Parts in this Series

[51052Series](#)

Mates With

N/A

Use With

Topcoated Ribbon Cable