

PLEASE CHECK WWW.MOLEX.COM FOR LATEST PART INFORMATION

Part Number: [043860022](#)
Status: **Active**
Overview: [Modular Jacks and Plugs](#)
Description: [Modular Jack, Right Angle, Low Profile, Inverted, Lightpipes, 6/6, Unshielded](#)

Documents:

[3D Model](#) [Packaging Specification PK-43860-004 \(PDF\)](#)
[Drawing \(PDF\)](#) [RoHS Certificate of Compliance \(PDF\)](#)
[Product Specification PS-43860-003 \(PDF\)](#)

Agency Certification

CSA LR19980
 UL E107635

General

Product Family [Modular Jacks/Plugs](#)
 Series [43860](#)
 Comments [Polysulfone Lightpipes](#)
 Component Type [PCB Jack](#)
 Magnetic [No](#)
 Overview [Modular Jacks and Plugs](#)
 Performance Category [3](#)
 Power over Ethernet (PoE) [N/A](#)
 Product Name [RJ11](#)
 UPC [800756499086](#)

Physical

Boot Color [N/A](#)
 Color - Resin [Black](#)
 Durability (mating cycles max) [500](#)
 Flammability [94V-0](#)
 Inverted / Top Latch [Yes](#)
 Jack Height [13.21mm](#)
 Keying to Mating Part [None](#)
 Lightpipes/LEDs [Lightpipes](#)
 Material - Metal [Phosphor Bronze](#)
 Material - Plating Mating [Gold](#)
 Material - Plating Termination [Tin](#)
 Material - Resin [High Temperature Thermoplastic, Polysulfone](#)
 Net Weight [2.757/g](#)
 Orientation [Right Angle \(Side Entry\)](#)
 PCB Locator [Yes](#)
 PCB Retention [Yes](#)
 PCB Thickness - Recommended [1.57mm](#)
 Packaging Type [Tube](#)
 Panel Mount [Without Flange](#)
 Pitch - Mating Interface [1.02mm](#)
 Pitch - Termination Interface [1.02mm](#)
 Plating min - Mating [1.270µm](#)
 Plating min - Termination [2.540µm](#)
 Ports [1](#)
 Positions / Loaded Contacts [6/6](#)
 Surface Mount Compatible (SMC) [No](#)
 Temperature Range - Operating [-40°C to +85°C](#)
 Termination Interface: Style [Through Hole](#)
 Waterproof / Dustproof [No](#)
 Wire/Cable Type [N/A](#)

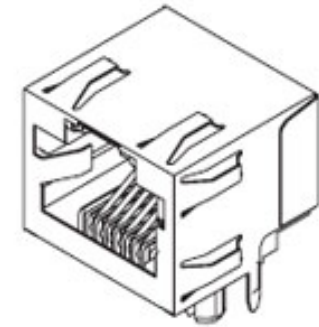

Series image - Reference only

EU ELV

Not Relevant

EU RoHS

Compliant

REACH SVHC

Not Contained Per -
 ED/21/2016 (20 June
 2016)

Halogen-Free

Status

Not Low-Halogen

**Need more information on product
 environmental compliance?**

Email productcompliance@molex.com
 Please visit the [Contact Us](#) section for any
 non-product compliance questions.

China ROHS

ELV

Green Image

Not Relevant

Search Parts in this Series

[43860 Series](#)

Mates With

[FCC 68 Plugs](#)

Electrical

Current - Maximum per Contact	1.5A
Grounding to PCB	No
Grounding to Panel	None
Shielded	No
Voltage - Maximum	150V AC (RMS)

Solder Process Data

Lead-freeProcess Capability	WAVE
-----------------------------	------

Material Info**Reference - Drawing Numbers**

Packaging Specification	PK-43860-004
Product Specification	PS-43860-003
Sales Drawing	SD-43860-001

This document was generated on 07/11/2016

PLEASE CHECK WWW.MOLEX.COM FOR LATEST PART INFORMATION