

# 2mm Hard Metric Connectors

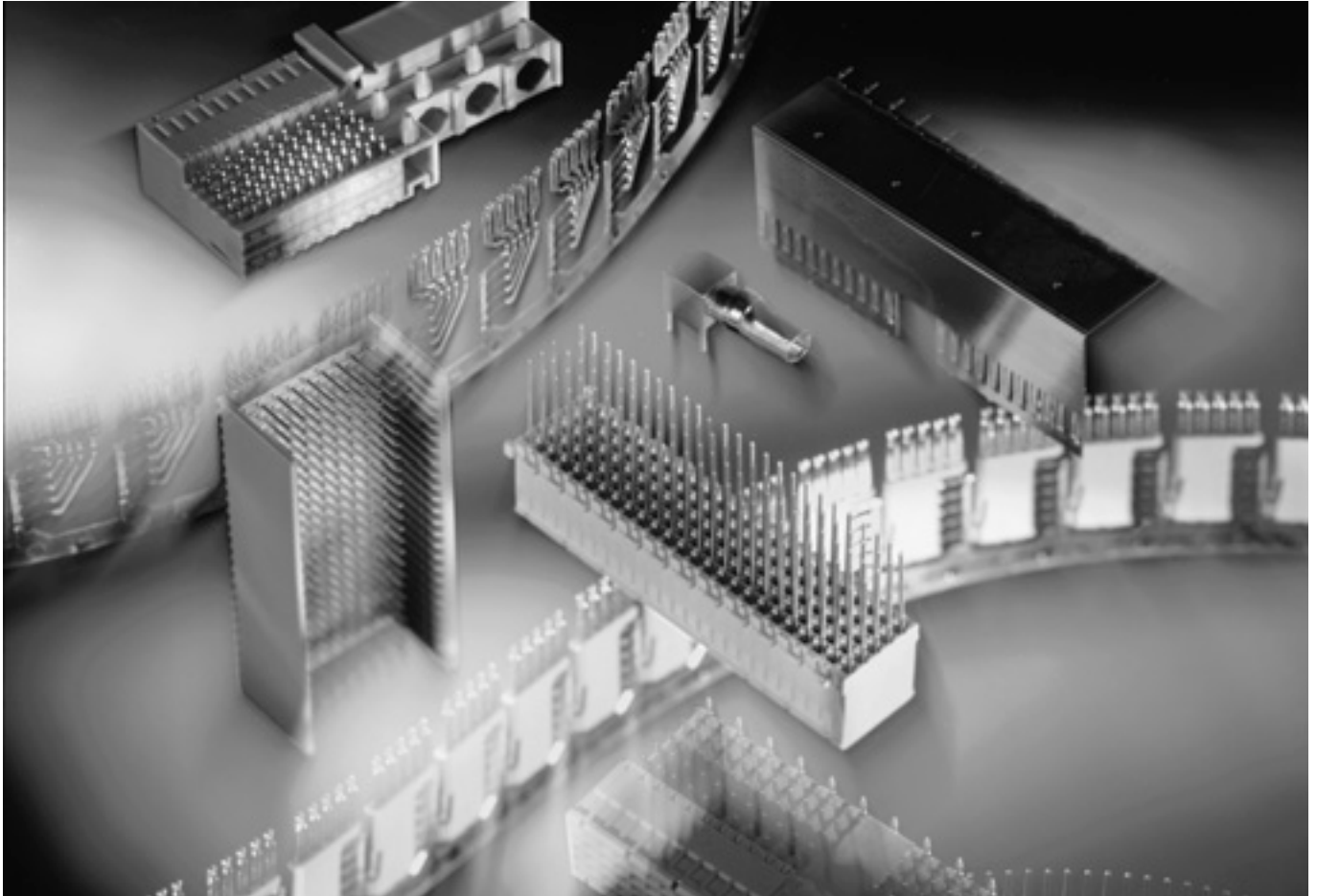

**ERmet**<sup>®</sup>

Acc. To IEC 61076-4-101

**Online Catalog** Updates of this catalog will be made available on the web: <http://Connect.ERNI.com/ERmet.ssi>

## Table Of Contents

ERmet 2mm Hard Metric Connectors	73
Product Overview	74
Complementary Components	78
Comparison Of 2.0 mm Connectors	79
Comparison Of 2.0 mm Connector Lines	80
Application Notes	81
Product Features	82
Design Requirements For Printed Circuit Boards	84
Alignment Tolerance	85
Midplane and Stacking Applications	85
Shroud Selection Information	86
Ordering Information	87
Mechanical Specifications And Performance	89
Electrical And Mechanical Characters For Power Modules	90
7-Row Electrical Performance	93
High Frequency Characteristics	93
7-Row Electrical Performance	94
10-Row Electrical Performance	95
High Frequency Characteristics	95
10-Row Electrical Performance	96
Approval Certificates, Performance Levels And Ordering Information	97
Right Angle Female Connectors Type A For Daughter Cards	98
Vertical Male Connectors Type A For Backplanes	100
Vertical Female Connectors Type A	105
Right Angle Female Connectors Type B For Daughter Cards	109
Vertical Male Connectors Type B For Backplanes	112
Vertical Female Connectors Type B	118
Right Angle Female Connectors Type AB For Daughter Cards	123
Vertical Male Connectors Type AB For Backplanes	126
Right Angle Female Connectors Type C For Daughter Cards	128
Vertical Male Connectors Type C For Backplanes	130
Vertical Female Connectors Type C	133
Right Angle Female Connectors Type D For Daughter Cards	137
Vertical Male Connectors Type D For Backplanes	139
Vertical Female Connectors Type D	141
Right Angle Female Connectors Type E For Daughter Cards	143
Vertical Male Connectors Type E For Backplanes	145
Vertical Female Connectors Type E	147
Right Angle Female Connectors Type DE For Daughter Cards	149
Vertical Male Connectors Type DE For Backplanes	151
Right Angle Female Connectors Type F For Daughter Cards	153
Vertical Male Connectors Type F For Backplanes	155
Vertical Female Connectors Type F	157
Right Angle Female Connectors Type L For Daughter Cards	159
Vertical Male Connectors Type L For Backplanes	161
Right Angle Female Connectors Type M For Daughter Cards	163
Vertical Male Connectors Type M For Backplanes	165
Right Angle Female Connectors Type N For Daughter Cards	167
Vertical Male Connectors Type N For Backplanes	169
Shrouds Type A For Backplanes	171
Shrouds Type B For Backplanes	174
Shrouds Type C For Backplanes	178

## Table Of Contents

Shrouds Type AB For Backplanes .....	180
Shrouds Type D For Backplanes .....	184
Shrouds Type E For Backplanes .....	186
Shrouds Type F For Backplanes .....	188
Right Angle Female Monoblock Modules .....	190
Vertical Male Monoblock Modules .....	192
Right Angle Male Power Modules For Daughter Cards .....	194
Vertical Female Power Modules For Backplanes .....	196
Dust Covers For Type A, B, AB, D, E and DE .....	198
Coding Keys .....	200
Guide Pin For ERmet 10 Row Type D .....	201
Special Contacts For Type L, M And N .....	202
Modular press-fit tools for male and female connectors .....	203
Press-In-Tools For The Female Connectors .....	204
Press-In-Tools For The Male Connectors .....	205
Toolholder .....	205
3U CompactPCI® Daughter Card Layout .....	206
3U CompactPCI® Backplane Layout .....	207
6U CompactPCI® Daughter Card Layout .....	208
6U CompactPCI® Backplane Layout .....	209
9U 10-Row 2mm Daughter Card Layout .....	210
9U 10-Row 2mm Backplane Layout .....	211
IEEE 1301 Daughter Cards for IEC 61076-4-101 2mm HM Connectors .....	212
IEEE 1301 Backplane Layouts For IEC 61076-4-101 2mm HM Connectors .....	213
VME64 Extensions Daughter Card .....	214
VME64 Extensions Backplane .....	215
64 Bit CompactPCI® System Slot Pin Assignments .....	216
64 Bit CompactPCI® Peripheral Slot Pin Assignments .....	217
32 Bit CompactPCI® System Slot Pin Assignments .....	218
32 Bit CompactPCI® Peripheral Slot Pin Assignments .....	219
cPCI Computer Telephony P4 Pin Assignments .....	220
cPCI Computer Telephony Safety Classifications for J4/P4 .....	221
cPCI Computer Telephony P5 Pin Assignments .....	222
cPCI Computer Telephony Safety Classifications for J5/P5 .....	223
PXI Generic Peripheral Slot Pinout .....	224
VME64x on CompactPCI® J4/P4 and J5/P5 Pin Assignments .....	227
PMC Mezzanine Card I/O Pin Assignments .....	228
Single PMC's I/O Signal Mapping to CompactPCI® 3U J2 Connector .....	228
PMC Mezzanine Card I/O Pin Assignments .....	229
IP Mezzanine Module I/O Pin Assignments .....	230
Bellcore Lubrication .....	232
Glossary Of Terminology .....	233
ERNI Customer Request Form .....	236
Applications .....	239
Right Angle Male Connectors Type A for Daughter Cards .....	240
Right Angle Male Connectors Type A for Daughter Cards Ordering Information .....	241
Right Angle Male Connectors Type B for Daughter Cards .....	242
Right Angle Male Connectors Type b for Daughter Cards Ordering Information .....	243
Right Angle Male Connectors Type b for Daughter Cards Other Lengths Ordering Information .....	244
Right Angle Male Connectors Type C for Daughter Cards .....	246
Right Angle Male Connectors Type C for Daughter Cards Ordering Information .....	247

## ERmet 2mm Hard Metric Connectors

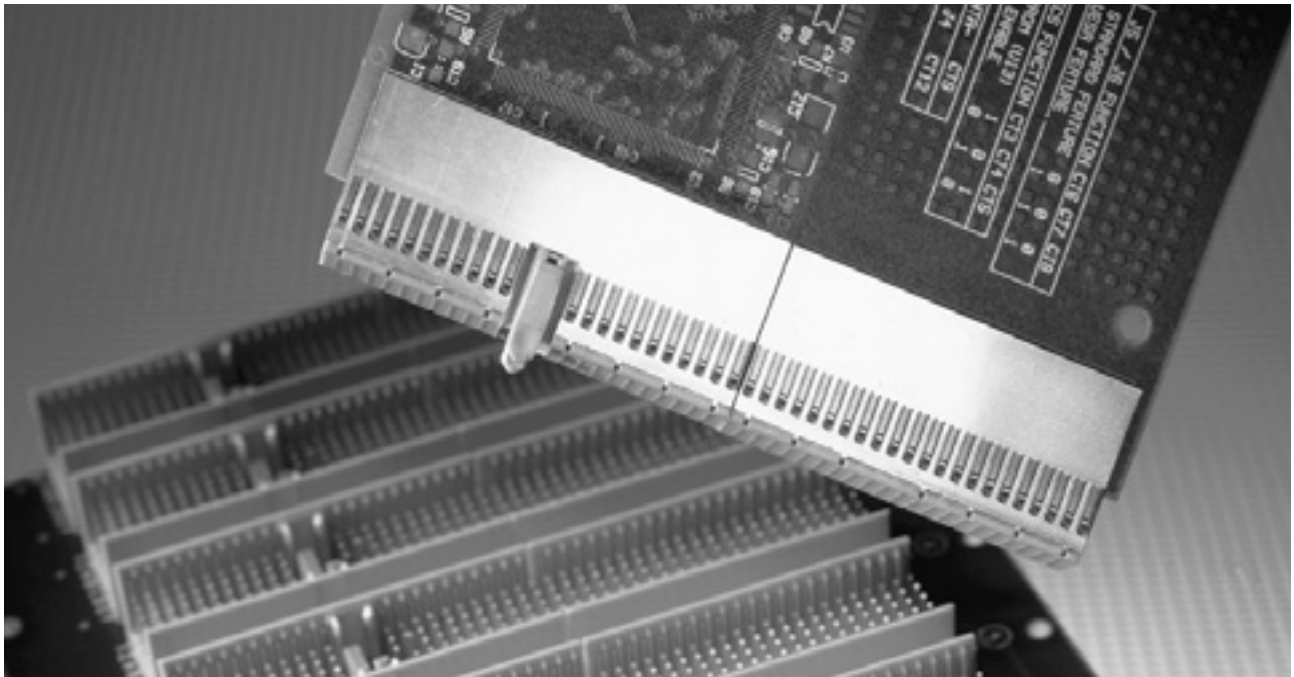

### Introduction

The ERmet 2mm H.M. connector line from ERNI offers unparalleled performance and flexibility for today's high performance circuit designs. Since its introduction in 1993, this product line has expanded and now offers almost every module configuration possible in a board to backplane interconnect system. Standard and reverse configurations are available including shielded vertical females, stacking designs, stamped power connectors and cable systems. This connector system has now become the standard for board to backplane applications.

The ERmet 2mm H.M. connector system has achieved widespread acceptance and popularity as the interconnect system chosen for CompactPCI. It is also widely used by OEMs serving the telecommunications and networking industry segments. It has achieved this unparalleled acceptance due to its high frequency performance, its wide selection of modular components and its cost-benefit ratio. This connector is supported by one of the industry's most comprehensive international connector standards, IEC 61076-4-101.

Whether you are developing a new backplane, a high performance CPU or I/O card or integrating a sophisticated hybrid system, ERNI has anticipated your needs. The ERNI team stands ready to partner with you to develop the most efficient solution to your design challenge.

### Features

- Modular connectors with 2.0 mm signal contact pitch for backplanes and daughter cards.
- High density board to backplane connector system.
- Up to 8 signal rows plus two shield rows for optimum performance.
- Three levels of sequential mating for front or rear hot swap applications. 1.5 mm increments.
- 15 standard contacts available for any pin loading requirement.
- Complete line of complementary accessories to include stamped power connectors, color coded coding keys, latching shrouds, cable connectors, ground return shields, high frequency, and high power contacts.
- Superior female connector contact design provides a uniform signal path.
- Comply to the international standard IEC 61076-4-101.
- For networking, telecommunications, high performance computing and other demanding applications.

## Product Overview

ERmet 2mm H.M. connectors are a versatile, cost-effective board-to-backplane solution for today's high performance, high density applications.

The ERmet 2mm H.M. line consists of 26 different module types including matching shrouds for midplane, stacking and cable applications, cable connectors, power modules, upper and lower ground return shields, coding keys and

cable latches.

For circuit design versatility, the connectors are offered with a selection of contacts including signal, high power, high frequency and coaxial. They are available in 50mm, 44 mm, 38 mm, and 25mm modules for end-to-end stacking without contact loss. The dual beam female contact design provides equalized signal path lengths which

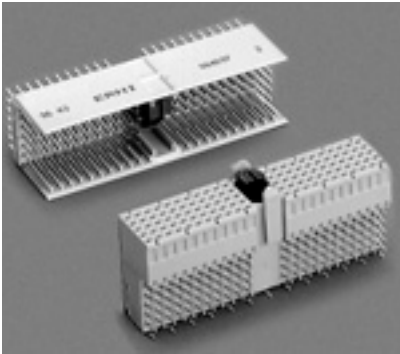

### Type A Connector

- 110 signal contacts.
- 44 shield contacts.
- 50 mm long including the multifunction area for coding keys.
- Integral pre-alignment guide and polarizing pins.
- Optional locating pegs for printed circuit board (PCB) mounting.
- 3 contact lengths for sequential mating.

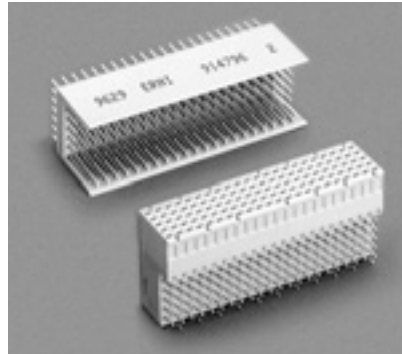

### Type B Connector

- 125, 110 and 95 signal contacts.
- 50 shield contacts.
- 50 mm, 44 mm and 38 mm long without the multifunction area.
- 3 contact lengths for sequential mating.

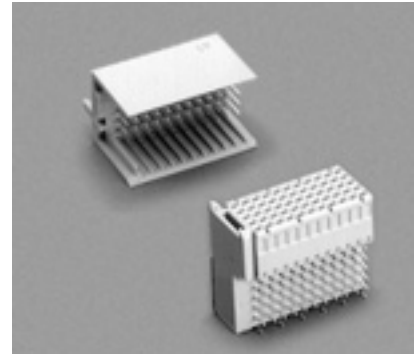

### Type C Connector

- 55 signal contacts.
- 22 shield contacts.
- 25 mm long.
- For end positions only.
- Pre-alignment guide pins.
- Optional locating pegs for printed circuit board (PCB) mounting.
- 3 contact lengths for sequential mating.

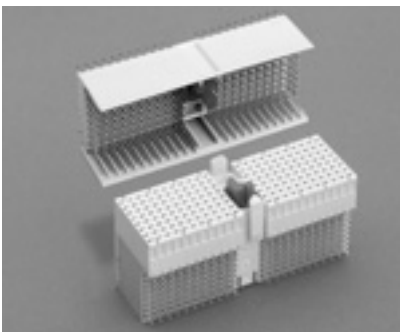

### Type D Connector

- 176 signal contacts.
- 44 shield contacts.
- 50 mm long including the multifunction area for coding keys.
- Integral pre-alignment guide and polarizing pins.
- Optional locating pegs for printed circuit board (PCB) mounting.
- Positions for optional early mate ground pin.
- 3 contact lengths for sequential mating.

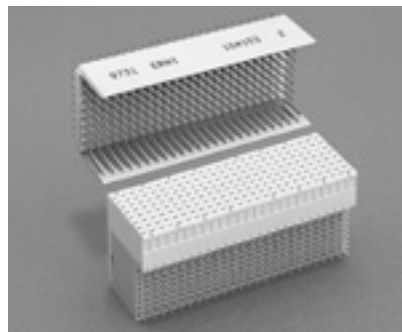

### Type E Connector

- 200 signal contacts.
- 50 shield contacts.
- 50 mm long without the multifunction area.
- 3 contact lengths for sequential mating.

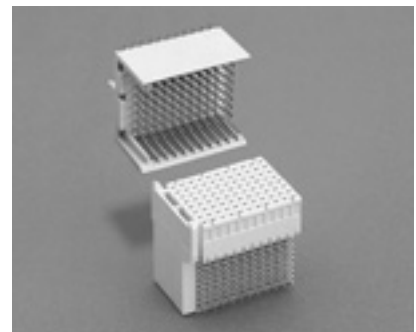

### Type F Connector

- 88 signal contacts.
- 22 shield contacts.
- 25 mm long.
- For end positions only
- Pre-alignment guide pins.
- Optional locating pegs for printed circuit board (PCB) mounting.
- 3 contact lengths for sequential mating.

## Product Overview

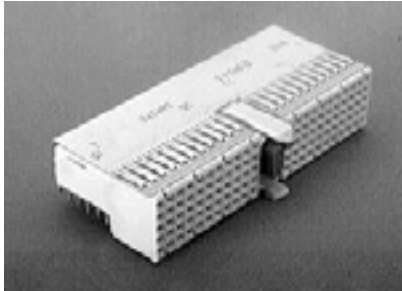

### Type A Ground Return Shield

- Upper and lower shields for Type A connectors.
- Upper shield available integrated with female connector or as separate component.

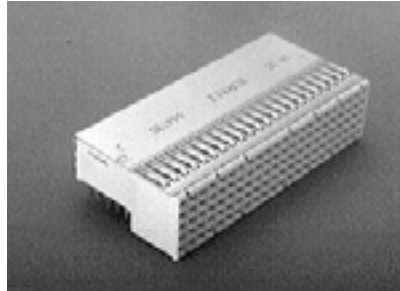

### Type B Ground Return Shield

- Upper and lower shields for the Type B female connectors.
- Upper shield available integrated with female connector or as separate component.

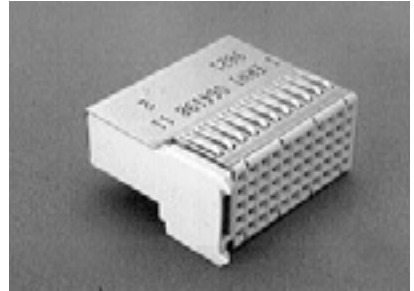

### Type C Ground Return Shield

- Upper and lower shields for Type C and M connectors.
- Upper shield available integrated with female connector or as separate component.



### Type D Ground Return Shield

- Upper and lower shields for Type D connectors.
- Upper shield available integrated with female connector or as separate component.

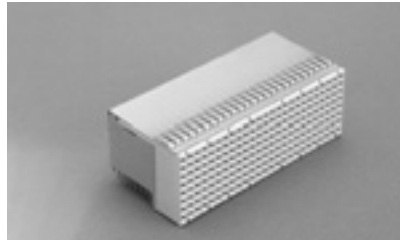

### Type E Ground Return Shield

- Upper and lower shields for the Type E female connectors.
- Upper shield available integrated with female connector or as separate component.

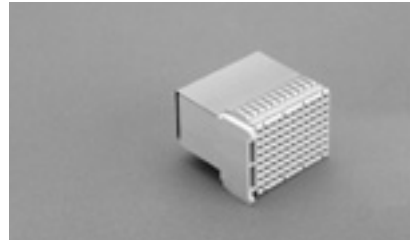

### Type F Ground Return Shield

- Upper and lower shields for Type F connectors.
- Upper shield available integrated with female connector or as separate component.

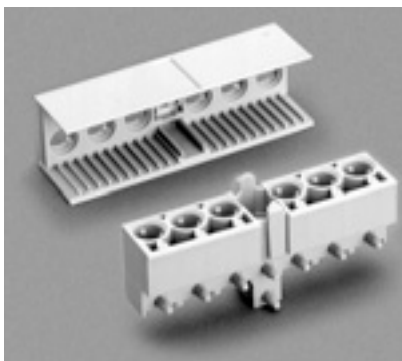

### Type L Connector

- 6 special contact cavities.
- 50 mm long.
- Multifunction area for coding keys.
- Integral pre-alignment guide and polarizing pins.
- Optional locating pegs for printed circuit board (PCB) mounting.

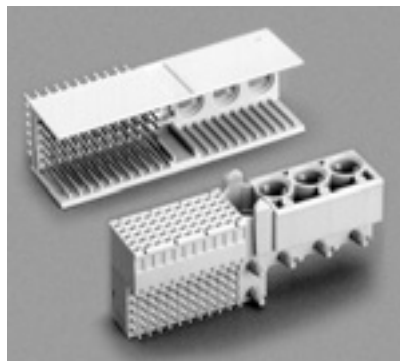

### Type M Connector

- 3 special contact cavities.
- 55 signal contacts.
- 50 mm long.
- Multifunction area for coding keys.
- Integral pre-alignment guide and polarizing pins.
- Optional locating pegs for printed circuit board (PCB) mounting.



### Type N Connector

- 3 special contact cavities.
- 25 mm long.
- For end positions only
- Pre-alignment guide pins.
- Optional locating pegs for printed circuit board (PCB) mounting.

## Product Overview

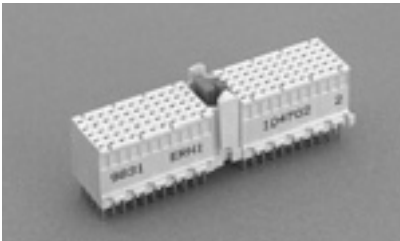

### Type A Vertical Female Connector

- 110 signal contacts.
- 44 shield contacts.
- 50 mm long including the multifunction area for coding keys.
- Pre-alignment guide and integral polarizing pins.
- Optional shields.
- Extended terminals and spacers available.

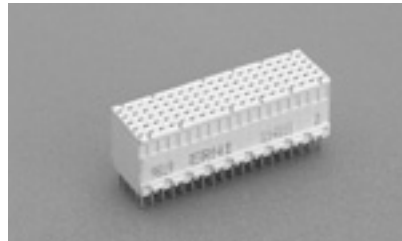

### Type B Vertical Female Connector

- 125, 110 and 95 signal contacts.
- 50, 44 and 38 shield contacts.
- 50 mm, 44 mm and 38 mm long without a multifunction area.
- Optional shields.
- Extended terminals and spacers available.

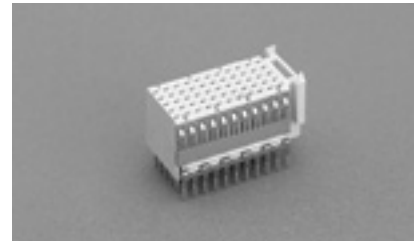

### Type C Vertical Female Connector

- 55 signal contacts.
- 22 shield contacts.
- 25 mm long.
- For end positions only
- Pre-alignment guide pins.
- Optional locating pegs for printed circuit board (PCB) mounting.
- Optional shields.
- Extended terminals and spacers available.

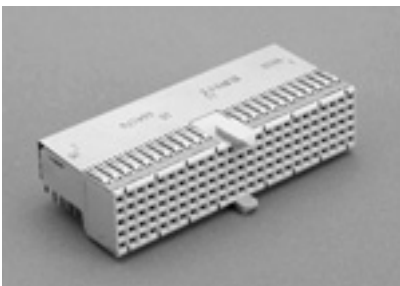

### Type AB25 Right Angle Female

- 125 signal contacts.
- 44 shield contacts.
- 50 mm long.
- Integral prealignment guide and polarizing pins.
- AB compatible males also available.

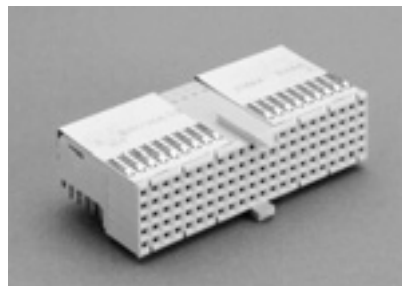

### Type AB22 Right Angle Female

- 110 signal contacts.
- 40 shield contacts.
- 44 mm long.
- Integral prealignment guide and polarizing pins.
- AB compatible males also available.

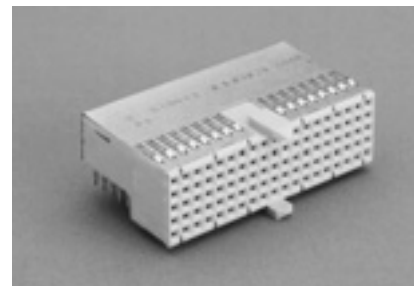

### Type AB19 Right Angle Female

- 95 signal contacts.
- 32 shield contacts.
- 38 mm long.
- Integral prealignment guide and polarizing pins.
- AB compatible males also available.

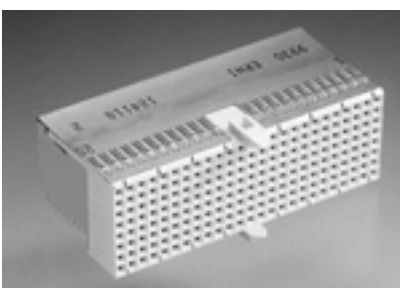

### Type DE Right Angle Female

- 200 signal contacts.
- 50 shield contacts.
- 50 mm long.
- Integral prealignment guide and polarizing pins.
- DE compatible males also available.

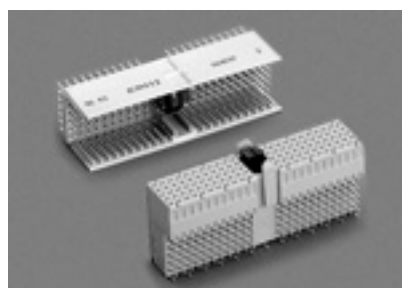

### Connector Coding System

- Up to 70 unique male and female coding keys.
- For use in the multifunction center of the Type A, D, L and M male or female connectors.
- Low cost, industry standard design.
- Easy snap-in installation – no epoxy adhesive required.
- Bright colors for quick visual identification conform to industry standard.
- Crush resistant construction, exceeds IEC requirements.



## Product Overview

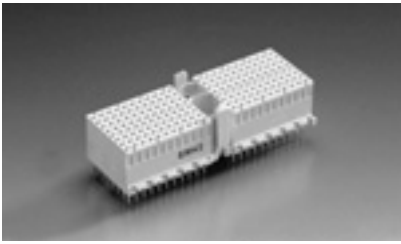

### Type D Vertical Female Connector

- 176 signal contacts.
- 44 shield contacts.
- 50 mm long including the multifunction area for coding keys.
- Pre-alignment guide and integral polarizing pins.
- Optional shields.

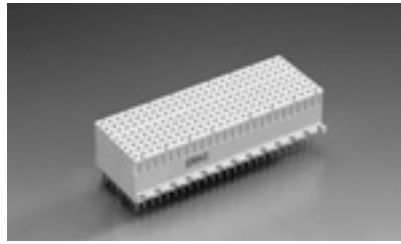

### Type E Vertical Female Connector

- 200 signal contacts.
- 50 shield contacts.
- 50 mm long without a multifunction area.
- Optional shields.

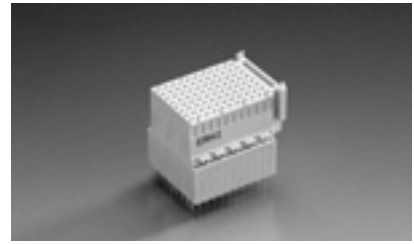

### Type F Vertical Female Connector

- 88 signal contacts.
- 22 shield contacts.
- 25 mm long.
- For end positions only
- Pre-alignment guide pins.
- Optional shields.



## Complementary Components

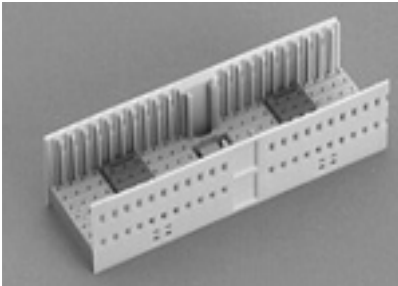

### Type A Shroud

- 4 heights for printed circuit boards (PCBs) 1.6 to 6.0 mm thick.
- 50 mm and 38 mm long.
- Multifunction area for coding keys.

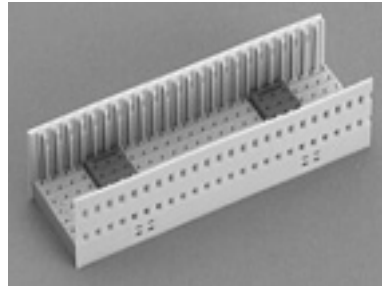

### Type B Shroud

- 4 heights for printed circuit boards (PCBs) 1.6 to 6.0 mm thick.
- 50 mm, 44 mm and 38 mm long.

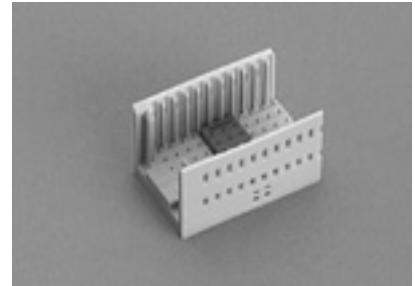

### Type C Shroud

- 4 heights for printed circuit boards (PCBs) 1.6 to 6.0 mm thick.
- 25 mm long.
- For end positions only.

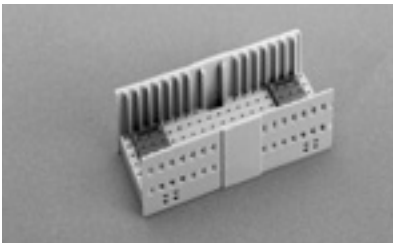

### Type AB 19 & AB 25 Shroud

- 38 mm and 50 mm respectively.
- Integral pre-alignment and guide pins.
- 4 heights for printed circuit boards (PCBs) 1.6 to 6.0 mm thick.

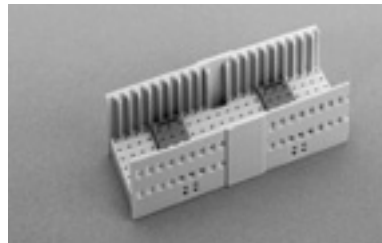

### Type AB 22 Shroud

- 44 mm long.
- Integral pre-alignment and guide pins.
- 4 heights for printed circuit boards (PCBs) 1.6 to 6.0 mm thick.

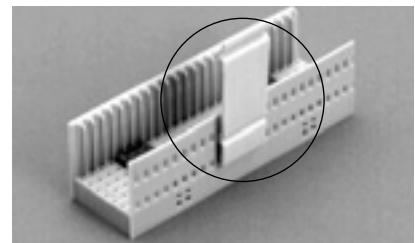

### Optional Latch Arm

- Can be added to standard ERmet shroud body.
- Spring action latch.
- Easy installation, no tools required.

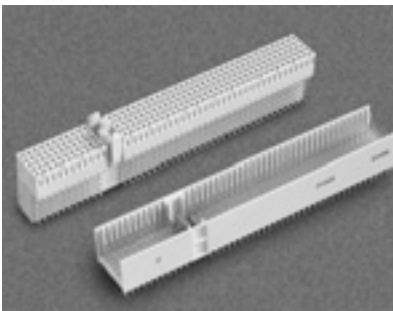

### Monoblock Modules

- Male and Female monoblock modules.
- Optional integrated coding keys for 3.3V, 5.0V or Telecom applications.
- Multifunction area for coding keys.
- Available in a variety of configurations 94 or 100 mm long.

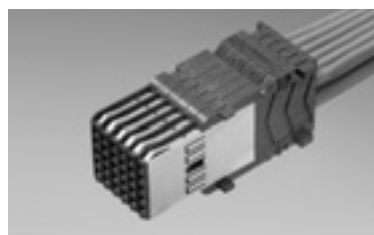

### Cable System

- Compatible with ERmet latching shrouds.
- 1 x 7 or 1 x 5 stackable housings can be joined together.
- Maintains "z" and "f" row shield path.
- High frequency contact design.
- Molded strain relief.

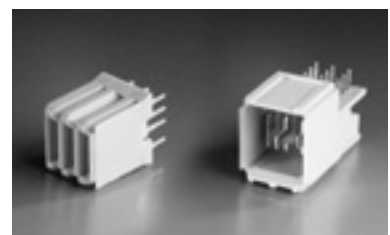

### Male & Female Power Module

- Closed entry female connector for backplane.
- 3 pin levels for sequential mating.
- 8 ampere, per contact.
- Pressfit, flat rock assembly.

## Comparison Of 2.0 mm Connectors

### A 2.0 mm Connector For CompactPCI Needs To Be Different. Here's Why.

When you're choosing a 2.0 mm connector for your product, it pays to give your choice a little extra thought. Just knowing a connector is a 2.0 mm connector is not enough – there are really three distinctly separate and non-intermateable connector lines. They are the Futurebus style, the HDM style and the Hard Metric style, such as the ERmet 2mm H.M. from ERNI for CompactPCI architecture.

All three connector systems use a 2.0 mm grid and are offered in modular formats, but there the similarity ends. Each line has different printed circuit board hole sizes, contact sizes, shield configurations, keying methods and electrical characteristics. In short, there are very few similarities beyond the 2.0 mm grids they share.

All three 2.0 mm connector designs consist of multi-row pin headers on the backplane, right angle female connectors on the daughter card and a 2.0 mm grid spacing. One immediate difference is in terminal area design. The HDM style has exposed terminals on the right angle daughter card female connector, while the Futurebus and Hard Metric designs have encapsulated terminals. The 5+2 row Hard Metric backplane connector is 3.0 mm more narrow than the 5+2 row Futurebus connector. The 7 (5+2) row Hard Metric connector is more narrow even than the 6 row HDM connector. The Hard Metric design preserves more space on the backplane for components that must be placed between the connectors.

The mating distances also differ between the three product lines. Mating distance is measured from the rear edge of the daughter card to the front surface of the backplane when the daughter card is fully seated. The Futurebus mating distance is 10 mm, while the mating distance for both Hard Metric and HDM is 12.5 mm. The 12.5 mm measurement is important because it matches the mating distance of the established DIN 41612 connectors and the 2.5 mm IEC 61076-4-100 connector.

Matching mating distances allows industries that use Euro-card packaging (IEC 273 or IEEE 1101 or 1101.10) to build systems that combine the popular 96 pin DIN connectors and the newer Hard Metric and HDM connectors. This supports legacy architectures while allowing the addition of new features that require the greater signal density of 2.0 mm connectors. The VME64 Extensions committee chose the Hard Metric connector system for the P0/J0 connector because of this advantage.

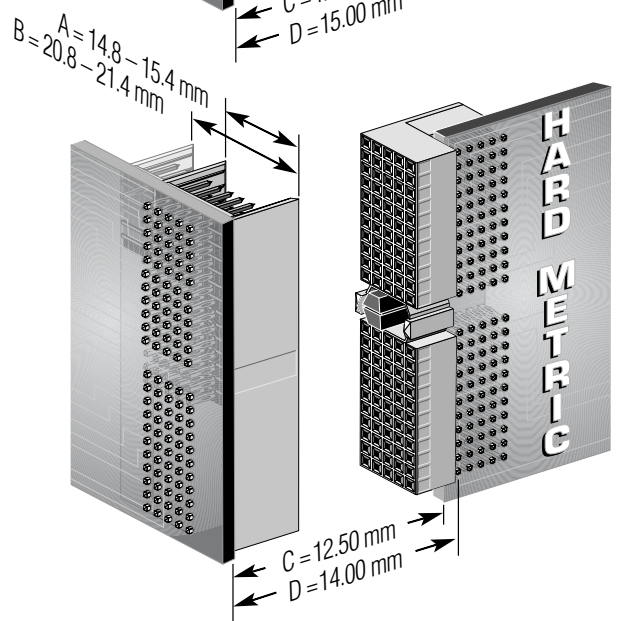
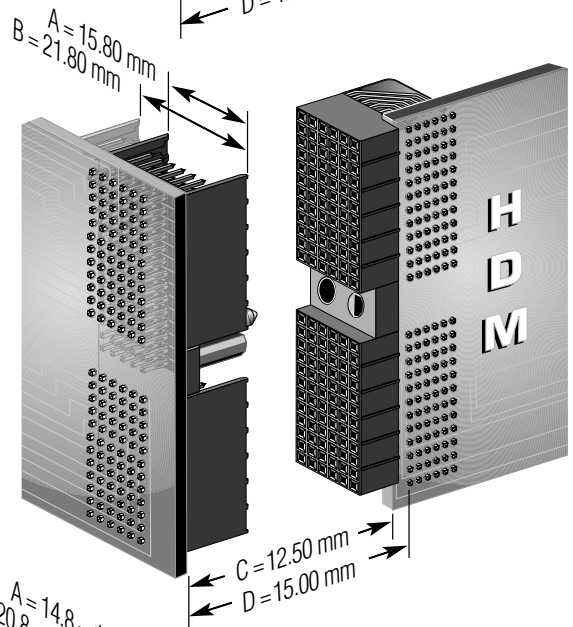
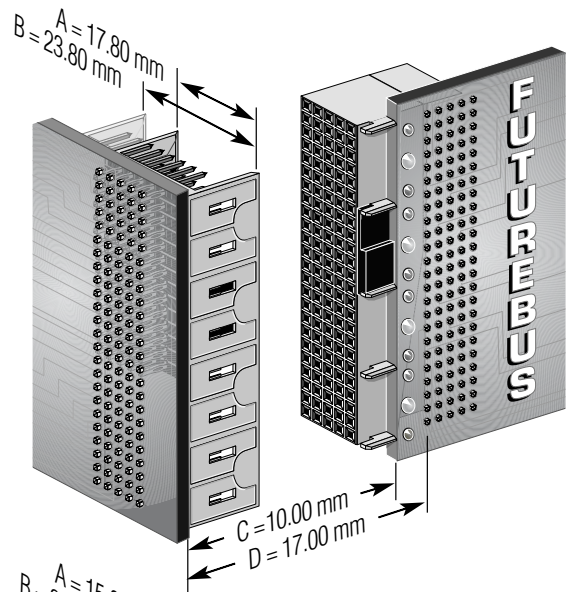

ERmet 2.0mm

\*Trademark of Teradyne Corporation

ERmet 2mm H.M. Connectors

## Comparison Of 2.0 mm Connector Lines

		Connector Lines		
Design Criteria HDM™		ERNI Futurebus 5+2/8+2	Hard Metric	
General Specification		Proprietary	IEC 1076-4-104	IEC 61076-4-101
Number of Rows (Signal and Ground)		6*	5+2	5+28+2
Total Contacts Per Linear Inch		76	88	88/127
Number of Standard Modules		3	7	6/15
Width of Male Housing		15.8 mm	17.8 mm	15.4 mm – 21.4 mm
Distance from Daughter Card Edge to Row A		250 mm	7.00 mm	1.50 mm
Mated Distance from Backplane Front to Row A		15.0 mm	17.0 mm	14.0 mm
Signal Mating Levels / Step Distance		3 levels, 0.50 mm each	5 levels, 0.75 mm each	3 levels 1.50 mm each
EMI Shielding		Yes	Yes <sup>+</sup>	Yes
Extended Guidance Features		See footnote <sup>+++</sup>	Add-On Module <sup>+</sup>	Integrated
Coding Locations		See footnote <sup>+++</sup>	Integrated	Integrated
Coding Combinations Per Location		8	3	70
Reverse Connector Configuration Vertical Male		Yes	Yes	Yes
Standard Connector Configuration Vertical Female		Yes	Yes <sup>+</sup>	Yes <sup>+</sup>
Power Contact Modules		Yes	Yes	Yes
Coaxial Contact Modules		Yes	Yes	Yes
Maximum Contact Resistance of Mated Pair		40 mΩ	50 mΩ	20 mΩ
Propagation Delay (max.) <sup>++</sup>		235 ps	210 ps	135 ps/190 ps
PCB Plated Hole Size		0.70 mm	0.70 mm	0.60 mm
Press-Fit Termination	Daughter Card	Yes	Yes	Yes
	Backplane	Yes	Yes	Yes

\* Shield Pins Implemented Through Signal Pins

+ Not Defined in (IEC) Specification

++ Published Industry Test Results

+++ Integrated in Header and add-on module for female

## Application Notes

The ERmet 2mm H.M. connector system now consists of two basic signal module configurations. The original 5+2 design and the newer 8+2 design for higher pin count requirements. Both connector systems consist of a daughter card mounted, right angle female connector featuring the high performance, low skew patented ERmet leaf contact design and a versatile vertical male header mounted on the backplane. Additionally, this arrangement is particularly effective for midplane application and makes sequential mating easy.

ERNI can provide 15 standard pins in any row or position required for your design. This allows for three levels of sequential mating in both the front and rear of the backplane, as well as two shorter terminal lengths for applications which don't require rear feed through pins.

For midplane and rear I/O applications, ERNI offers complementary 2.0 mm shrouds, vertical female connectors, cable connectors and latch accessories which are used in conjunction with the long terminal lengths (R1, R2 and R3).

Specific contact loading configurations have already been defined for standard applications and special needs like live insertion on CompactPCI. However, to specify a custom loading configuration, use the ERNI customer request forms located in the back of the catalog. A form is provided for the 5+2 configuration and another form is available for the 8+2 configuration.

### Features

- 3 step lengths in 1.5 mm increments ensure dependable sequential mating.
- Both front and rear mating areas meet the same IEC performance level.
- 15 pin lengths defined by IEC 61076-4-101.
- Long terminal contacts (R1, R2 and R3) require the use of rear shrouds.

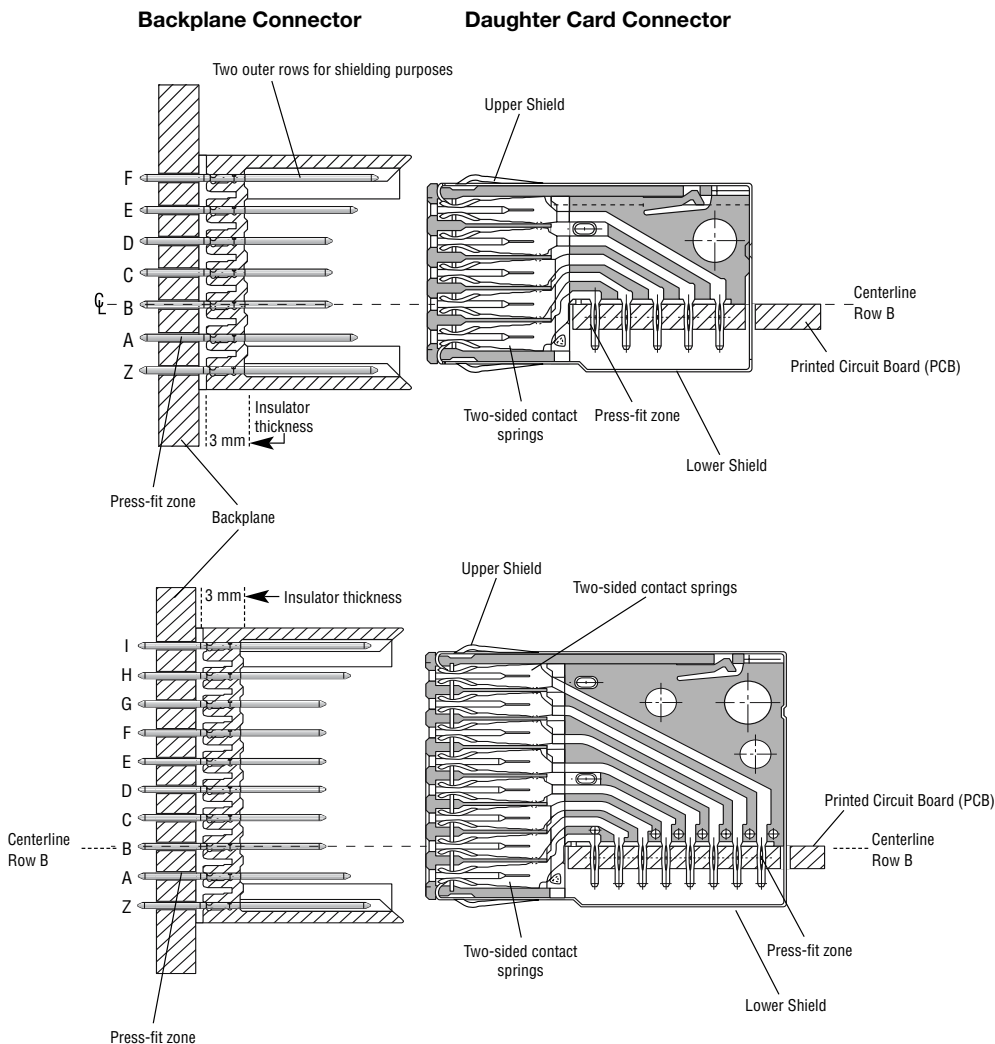

## Product Features

### AB Alignment Option (features)

The IEC 61076-4-101 connector standard only provides for connector Types A, B, C, D, E, F, L, M and N. Many customers require a connector with the density of a Type B (25 columns) and with the pre-alignment guide pins of the Type A, D, L and M connectors. This became a particular issue within the CompactPCI computer architecture for rear plug in applications where only B connectors were being used. The problem is that if a plug in card only utilizes Type B connectors, the cards will not have adequate vertical alignment even in the most carefully constructed subrack. The result can be pin stubbing and ultimately serious damage to both the backplane connectors and the female connectors on the daughter cards. For our customers who need a solution to this situation or who need the additional 15 pins that a Type B connector provides, but who also need the vertical alignment that the pre-alignment guide pins afford, ERNI has developed the Type AB connector. This new AB design, which does not allow for coding keys, is now required for rP3 and rP5 shrouds by the current draft PICMG Core specification (draft 3.0).

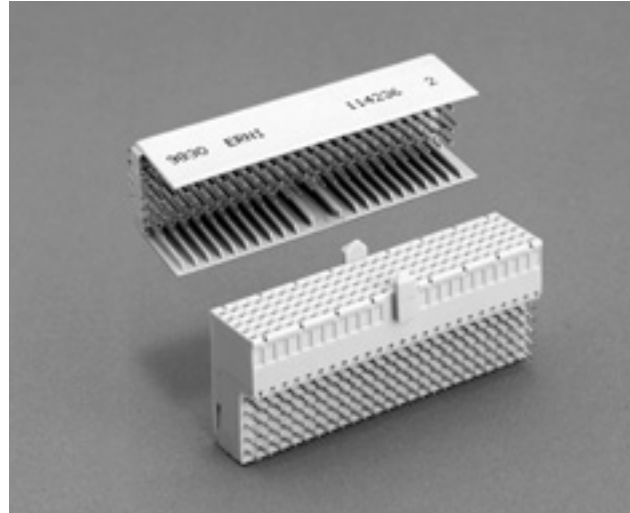

### Coding Keys

CompactPCI® supports both conventional 5.0 V logic and 3.3 V logic. To prevent damage to the system resulting from incorrect insertion of cards with differing logic, coding keys are snapped into the multi-functional area of the male and female connector. This is done with the use of a plastic tool after the connector has been pressed in. The unique, bright color of the coding pairs allows for quick and easy visual identification and differentiation. For the 5.0 V logic, CompactPCI® use brilliant blue coding keys, 3.3 V logic use cadmium yellow and Telecom applications use strawberry red. The IEC 61076-4-101 standard defines a unique configuration and color for 70 different coding keys. The ERNI design has special integral supports that exceed the IEC requirements.

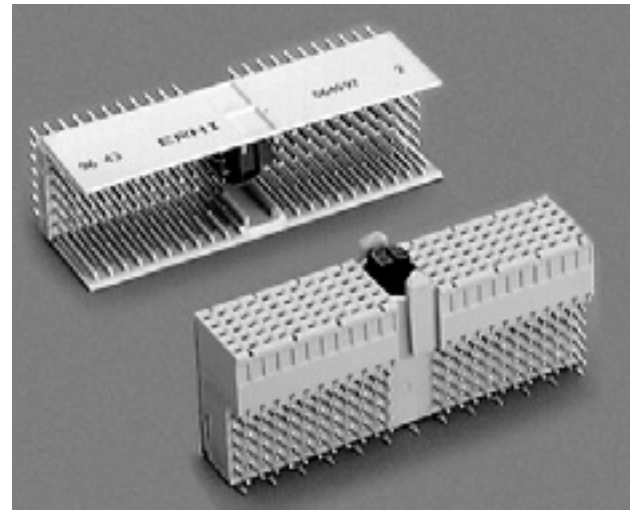
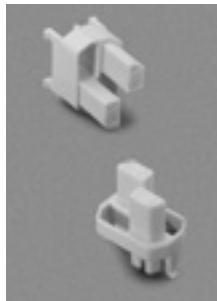

**Male Contact Range**

The ERmet 2mm H.M. Connector System has one of the longest wipe areas of any connector system as defined in IEC 61076-4-101. This ensures reliable contact mating even under adverse mating conditions. Features include:

- 2.5 mm minimum wipe length for all three contact lengths.
- The required wipe length for rear applications may be achieved by selecting the proper rear shroud height for the backplane thickness.
- IEC standardization completely defines tip blade and contact geometry, thus ensuring intermatability.

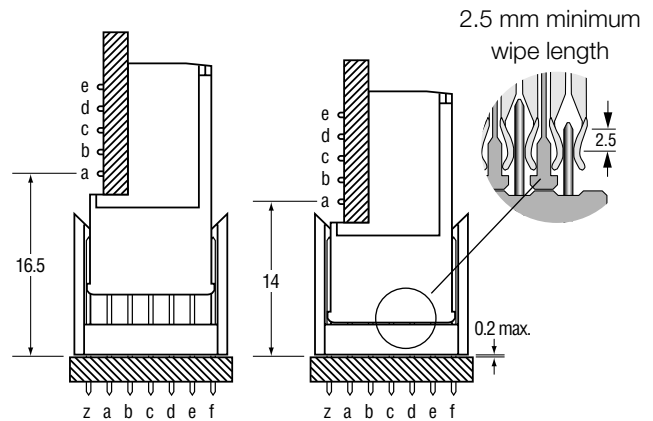

**Relation To IEEE 1101.10 And IEC 297.3**

The ERmet 2mm H.M. Connector System has been chosen by the PICMG for the CompactPCI bus architecture and the VITA Standards Organization for the VME64 Extensions, PO/JO connector. Both of these applications require this connector to be used in 0.8" wide slots in accordance with IEC 297.3 and IEEE 1101.10 mechanical chassis requirements. This chassis system defines the daughter card location within the card slot, relative to the interboard separation planes. When the ERmet Connector System is used within such a chassis system, the dimensions shown in the drawing will be observed. ERNI has designed the lower shield to

avoid any interference with the interboard separation plane. This ensures that the daughter card and shield assembly will not snag or interfere with high components in the adjacent slot during installation or removal.

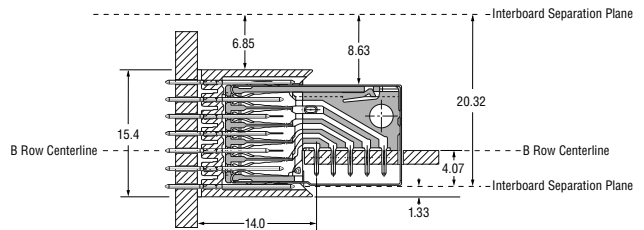

**Male Contact Selection Options**

The ERmet 2mm H.M. Connector System offers 15 standard contact lengths that utilize the proven pressfit assembly technique. Within the 15 contact lengths are 3 mating levels, achievable on both the plug-in and rear I/O side. Note you always keep 1.5 mm spacing between levels, for enhanced sequential mating.

On the plug-in side, the 3 contact levels are: 8.2 mm, 9.7 mm and 11.2 mm. On the rear I/O side there are 5 pressfit terminal length options: P1, P2, R1, R2, and R3. The P1 and P2 terminal lengths are for standard backplane applications with terminal lengths of 3.7 mm and 4.5 mm respectively. The R1, R2 and R3 terminal lengths are for rear I/O applications with lengths of 13.0 mm, 14.5 mm and 16.0 mm respectively. The optimum terminal length is determined by the printed circuit board thickness, rear shroud height and the desired mating level.

For contact plating information, refer to the Mechanical Specifications. To specify custom loading configurations, use the ERNI Customer Request Form.

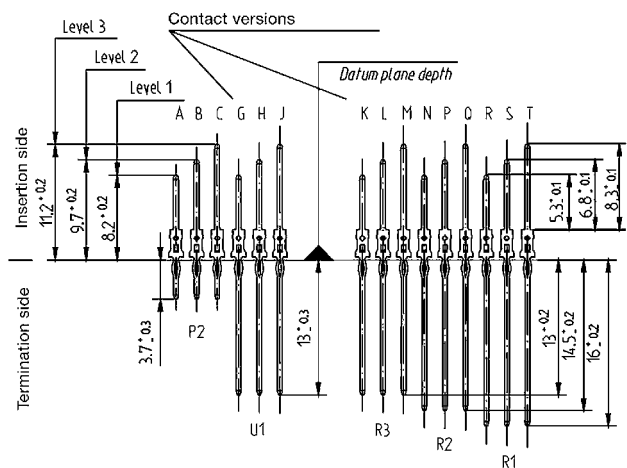

## Compliant Pressfit Pins

The ERmet 2mm H.M. connector line utilizes the proven pressfit assembly method. This design was chosen because it is an efficient assembly method that offers a number of benefits over soldering including higher reliability, easier inspection and repairability, and easier installation. In addition, the pressfit method avoids exposing the high layer count printed circuit boards (PCBs) to the additional thermal stress of soldering.

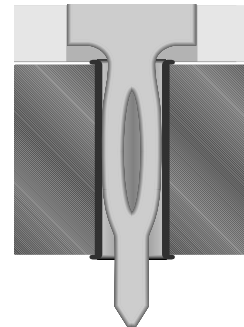

## Design Requirements For Printed Circuit Boards

### Plated Through-hole For Pressfitting Signal Contacts, Power Contacts And Shielding Contacts

All ERmet 5+2 row and 8+2 row signal contacts are pressfit. In addition, the bladed ERmet power connectors are also pressfit and share the same board plated hole requirements as the male and female signal connectors. The ERmet 2mm H.M. Connectors have been used successfully with reflowed tin-lead, plated tin-lead, immersion tin, organic coatings over bare copper and immersion gold hole plating regimes. The hole recommendations and press in force information shown in this catalog are for reflowed tin-lead and plated tin-lead. Additional test data for other hole plating regimes are available through customer service.

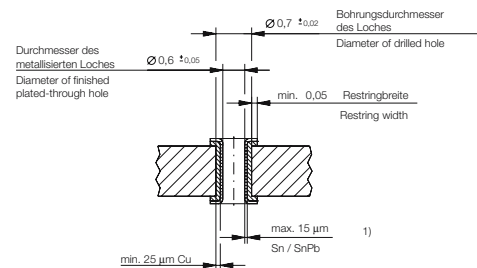

### Plated Through-hole For Pressfitting High-current Contacts (Special Contacts For Modules L, M And N)

The ERmet Type L, M and N connectors have provisions for high frequency coaxial and high current circular contacts. These contacts have a variety of different plated through-hole requirements. For these, please consult ERNI Customer Service.

However, ERNI does offer both 20 Amp and 40 Amp high power pressfit contacts for the L, M, and N connectors, which have the specific plated through-hole requirements shown to the right.

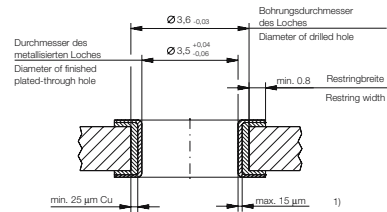
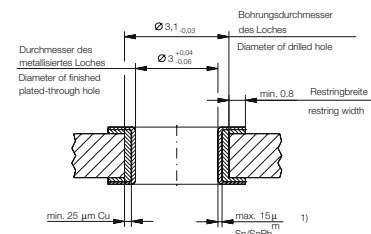

### Maximum Circuit Density

The dense ERmet 2.0 mm grid spacing utilizes a 0.6 mm plated through via. This via diameter, together with an appropriate plated annular ring, leaves a 1.0 mm minimum space between adjacent annular rings for trace routing. This space allows for either two equally spaced conductor traces of 0.2 mm (.008") wide or three equally spaced conductors 0.14 mm (.006") wide, as shown in the drawing to the right. This layout can be used to bus two or three rows of the connector on each layer respectively. Many designers bus each row on a separate layer with a ground or power layer between for best signal integrity.

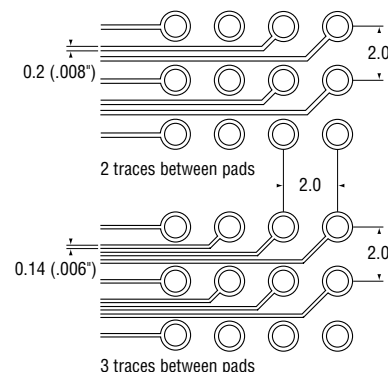

## Alignment Tolerance

The pre-alignment pins ensure accurate alignment, eliminating the possibility of pin stubbing on the female insulator. When modules with the pre-alignment feature are used, the following mating tolerances can be accommodated:

- Up to 2.0 mm of vertical or horizontal misalignment.
- Up to 2 degrees of vertical or horizontal angular inclination.

### Allowed Misalignment

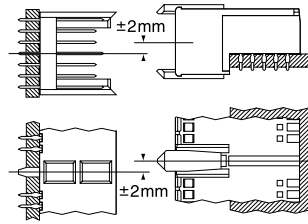

### Allowed Angular Inclination

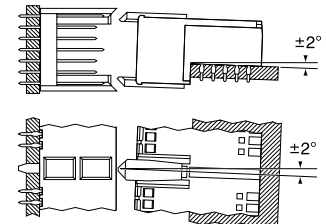

## Midplane and Stacking Applications

### Midplane – inline

The most common configuration for mid plane application: is to have a rear shroud over long terminals. The rear shroud is oriented so that the shroud's "a" row lines up with the "a" row of the male connector on the front side of the backplane. In this configuration, the card guides in the front of the backplane line up exactly with those behind the backplane.

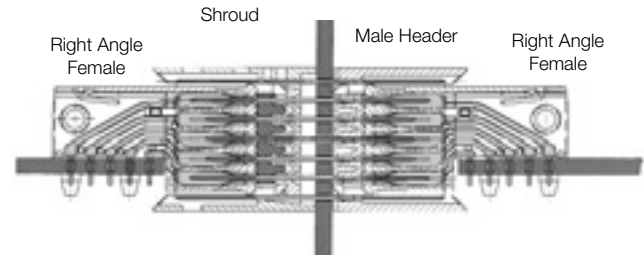

### Midplane – out of line

This less common configuration has the "a" row of the shroud aligned with the "e" row of the male connector on the front side of the backplane. In this configuration, the card that plugs into the rear side has the same appearance as the board that plugs into the front side of the backplane. This usually requires a more complex card guide arrangement than the inline configuration.

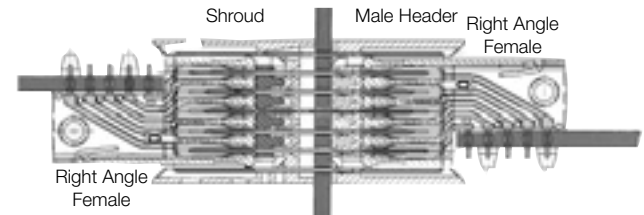

### Parallel stacking

This configuration has a vertical female connector on a mezzanine board mating into a rear shroud on the rear of a backplane. This is a very popular method often used to connect two or more slots with a PCB which is parallel to the backplane. This is a common solution for switched fabrics such as Raceway or for modular dedicated bused lines such as a special processor to board memory bus. The ERmet vertical female is also available with long tails to allow two levels of stacking. The ERNI vertical female has shields so all male pins can be contacted. Vertical females with long terminals are available for additional levels of stacking.

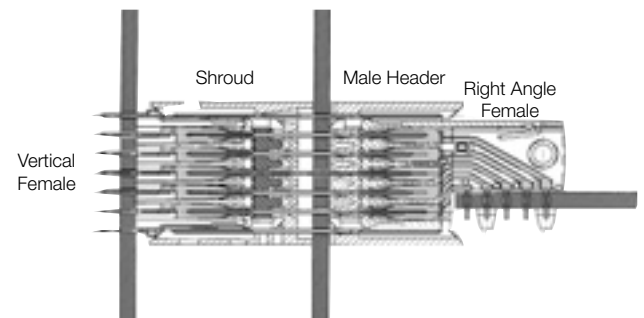

### Cable I/O

All ERmet rear shrouds can be fitted with optional latch arms. This can be done during backplane assembly or later by the end customer. The latch arms allow the ERmet 2mm cable connector to be retained by the shroud. The ERmet 2mm cable system also mates with the "z" and "f" shield rows. This cable system is a very flexible method for taking high speed signals from one backplane to elsewhere in a system or even to an adjacent backplane.

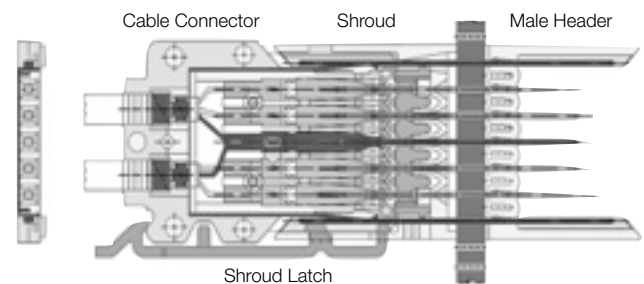



## Shroud Selection Information

After the backplane has been designed and its final overall thickness is determined, it is often challenging to select the proper shroud. Furthermore, a design may specify sequential mating in the rear which requires several different terminal lengths.

To accommodate a wide range of backplane thicknesses and up to 3 rear mating levels, ERNI offers shrouds with 4 different base thicknesses. Which base thickness you select depends on both the backplane thickness and the number of terminal lengths you need. Note that due to the extremely long contact wipe length (2.5 mm), several different combinations of pin terminal lengths and shroud base thicknesses may be used to achieve the same functional result.

The chart at right shows for each of the four shroud base thicknesses, which connector terminal lengths (R1, R2 or R3) may be used for any specific backplane thickness (1.5 mm to 8.0 mm).

### Examples:

- For a backplane thickness of 2.5 mm and the need to accommodate all three rear mating lengths (terminals R1, R2 and R3), a shroud base thickness of 6.1 mm must be used.
- With a 5.0 mm thick backplane and a shroud with a 5.3 mm base thickness, only the R1 and R2 terminal length pins may be used. The R3 terminal would be too short to ensure the proper wipe length for reliable mating.
- With a 3.0 mm thick backplane and a shroud with a 5.3 mm base thickness any R1, R2 and R3 terminal length pin may be used.

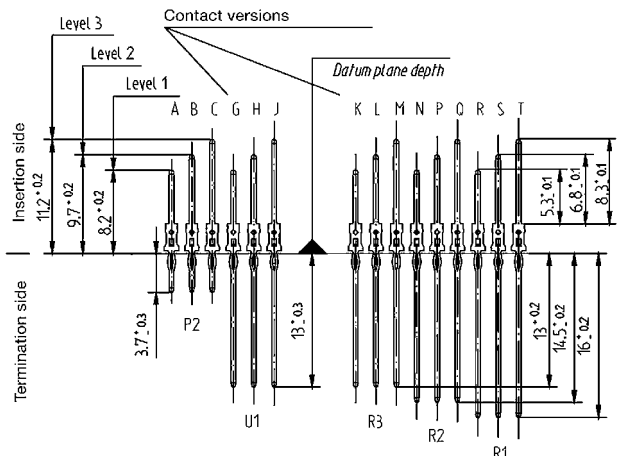
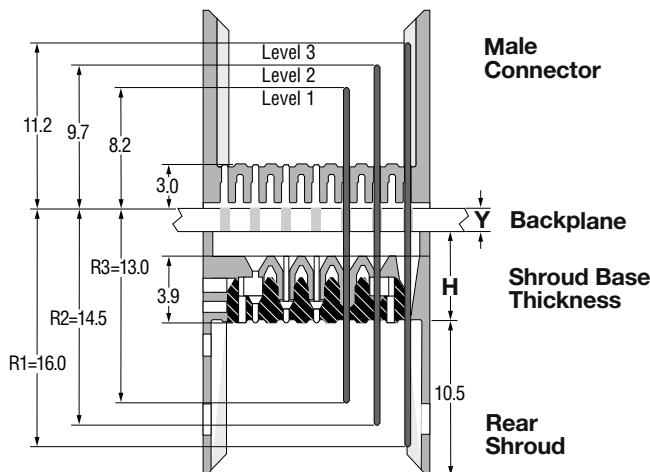
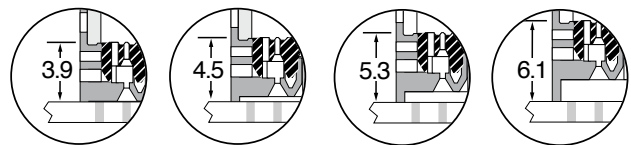
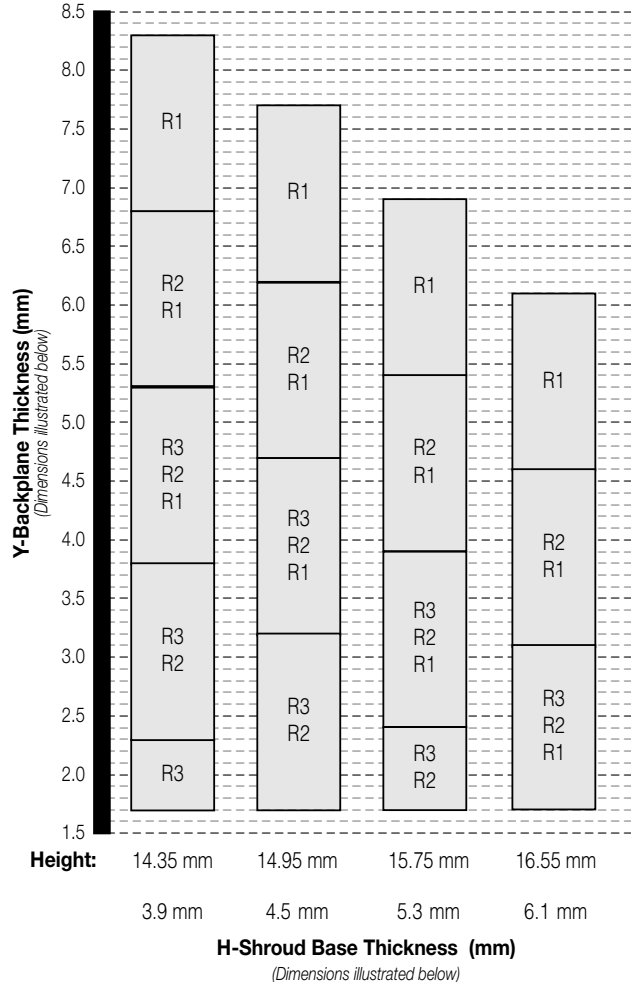

## Ordering Information

### Shroud Selection Chart

Description	Base Thickness (mm)	Length (A) (mm)	Shroud Part #	Tool for Press* Assembly
Type A25 Shroud <b>CompactPCI®</b> rP1 and rP4 positions	3.9	49.9	114436	914070
	4.5	49.9	054795	914070
	5.3	49.9	054794	914070
	6.1	49.9	054793	914070
Type A19 Shroud	3.9	37.9	NA	914079
	4.5	37.9	923109	914079
	5.3	37.9	923108	914079
	6.1	37.9	923107	914079
Type AB25 Shroud	3.9	49.9	114482	914690
	4.5	49.9	114483	914690
	5.3	49.9	114484	914690
	6.1	49.9	114485	914690
Type AB22 Shroud <b>CompactPCI®</b> rP2 and rP5 positions	3.9	43.9	114425	914691
	4.5	43.9	114426	914691
	5.3	43.9	114427	914691
	6.1	43.9	114428	914691
Type AB19 Shroud <b>CompactPCI®</b> rP3 position	3.9	37.9	114487	914692
	4.5	37.9	114488	914692
	5.3	37.9	114489	914692
	6.1	37.9	114490	914692
Type B25 Shroud	3.9	49.9	114437	914069
	4.5	49.9	054797	914069
	5.3	49.9	054798	914069
	6.1	49.9	054799	914069
Type B22 Shroud	3.9	43.9	114619	914083
	4.5	43.9	064692	914083
	5.3	43.9	064693	914083
	6.1	43.9	064694	914083
Type B19 Shroud	3.9	37.9	114618	914084
	4.5	37.9	064622	914084
	5.3	37.9	064623	914084
	6.1	37.9	064624	914084
Type C11 Shroud	3.9	24.55	114438	914068
	4.5	24.55	064172	914068
	5.3	24.55	064171	914068
	6.1	24.55	064170	914068
Tool for Manual Assembly	–	–	064202	–
Latch Arm	–	–	064219	–
Replacement Locking Wafers	–	–	–	054521

Dimensions shown are for reference purposes only. All dimensions are in millimeters (mm) unless otherwise noted.

\*The tools are the same tools used to pressfit the equivalent male connectors. The tools listed will only accommodate pins extending no more than 8.7 mm from the inside floor of the shroud. Calculated as follows: [8.7 mm > 16.0 mm – (BP thickness (mm) + shroud base thickness (mm))]

## Connector System Modularity And Configuration

### Modularity

The ERmet 2mm H.M. connector has been designed in accordance with IEC 61076-4-101, with eleven basic connector types: A, B, AB, C, D, E, DE, F, L, M and N. These connectors can be assembled end to end in a great variety of combinations but certain guidelines must be followed: You cannot mix 5+2 and 8+2 versions except under some very special situations.

Type B connectors cannot be used alone. A Type B connector must be used in conjunction with a module containing a pre-alignment guide such as connector types A, AB, C, L, M or N.

Type E connectors cannot be used alone. A Type E connector must be used in conjunction with a module containing a pre-alignment guide such as connector types D, DE or F.

Type C, N and F connectors must be assembled at the lower end of a connector stack.

Each end of the connector is designed so that the modules "nest" together. This provides additional support for the side walls and makes for a very neat appearance.

When shrouds are used on the rear side of a backplane, care must be taken to align the shrouds properly. The correct orientation will depend upon the configuration of the rear plug in cards. For most applications following the "inline" configuration, the rear shrouds will have the convex end detail facing down which is opposite to the arrangement depicted in the detailed drawing on this page. The "a" row of the shroud will match the "a" row of the male connector.

### Male Connector Stacking And Connector End Details

The ERmet 2mm H.M. Connector System is a modular system designed to be assembled on a 2.0 mm grid. The connectors are designed with a unique locking feature which ties the sidewalls together. This ensures that any stress is shared across an entire connector stack when assembled as a group. The connector's convex top end and concave bottom end fit together, maintaining the dense 2.0 mm grid. The bottom of the VME64 Extensions JO connector is the one exception. It is molded flat across as it is not designed for modular stacking and would otherwise interfere with the DIN 41612 connectors. It can be used in a modular stacking configuration but will not benefit from interlocking sidewalls.

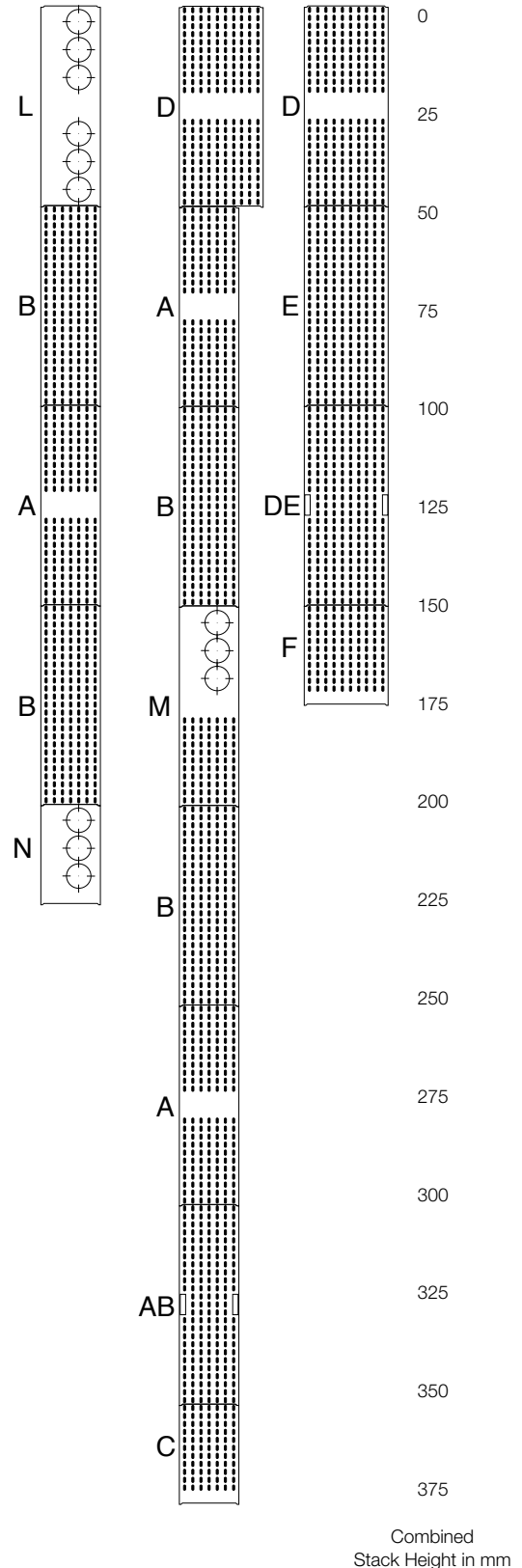
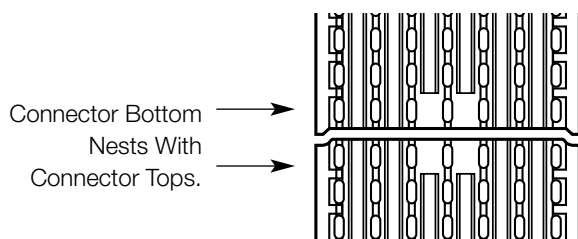

## Mechanical Specifications And Performance

### General Connector Specifications

Connector Pitch		20 mm
Temperature Range		-55°C to +125°C
Performance level 3 per 61076-4-101		≥ 50 mating cycles
Performance level 2 per IEC 61076-4-101		≥ 250 mating cycles
Performance level 1 per IEC 61076-4-101		≥ 500 mating cycles
Pressfit pin insertion (male or female)	0.55 mm hole	36 Newtons (N) typical
	0.65 mm hole	25 Newtons (N) typical
Contact Normal Force		0.8 Newtons (N)/contact
Insulation Resistance IEC 5122 Test 3a	Contact	10 <sup>4</sup> MΩ min @ 100DC
	Shield	10 <sup>4</sup> MΩ min @ 100 DC
Mating and with drawal force per IEC 5127, Test 13a	Contact	n x 0.75 Newtons (N) maximum (n=number of contacts)
	Ground pin to shield	n x 1 Newtons (N) maximum (n=number of contacts)
Withdrawal force per contact IEC 5127, Test 16e	Contact	0.15 Newtons (N) minimum
	Ground pin to shield	0.15 Newtons (N) minimum
Contact insertion force (per pin) IEC 3525 paragraph 3.222		36.3 Newtons (N) average (male or female)
Flammability		UL 94 V-0
Hole requirements for daughter card and backplane		0.6 mm ± 0.05 mm after plating
Contact Resistance per IEC 5122 Test 2a		20 m Ω maximum

### Male Contact and Housings

Housing Material (8+2) and (5+2)		PBT 30% Glass filled
Temperature Rating Per IEC 512		CTI 275 / CTI 175 M
Contact Material		Phosphor bronze
Contact Plating/Performance Level P1, P2	Contact area	Gold plated
	Compliant area	Sn
	Rear terminal	Sn
Contact Plating/Performance Level R1, R2 R3	Contact area	Gold plated
	Rear terminal	Gold plated

### Right Angle Female Contact and Housings

Housing Material (8+2)		LCP 30% glass filled
Housing Material (5+2)		PBT 30% Glass filled
Wafer (8+2) and (5+2)		PBT 30% Glass filled
Comperative figur of voltage IEC 112		CTI 275
Contact Material		Phosphor bronze
Contact Plating/Performance Level	Contact area	Gold plated
	Compliant area	Sn
Contact Normal Force		0.8 Newtons (N)/contact

### Vertical Females

Wafer (8+2) and (5+2) Material		LCP 30% Glass filled
Comperative figur of voltage IEC 112		CTI 275
Contact Material		Phosphor bronze
Contact Plating/Performance Level	Contact area	Gold plated
	Compliant area	Sn
	Extended Terminals	Gold plated

## Electrical And Mechanical Characters For Power Modules

### Ground Return Shields for Right Angle Female Connectors

Base material		Copper alloy
Contact plating per IEC 512Test 9A	Contact fingers	Gold plated
Performance level 2per IEC 61076-4-101		≥ 20 mating cycles
Hole requirements for daughter card		0.6 ±0.05 mm after plating

### Ground Return Shields for Vertical Female Connectors

Base material		Copper alloy
Contact plating per IEC 512Test 9A	Contact fingers	Gold plated
Terminal plating per IEC 512Test 9A	Extended terminals	Gold plated
Performance level 2per IEC 61076-4-101		≥ 20 mating cycles
Hole requirements for daughter card		0.6 ±0.05 mm after plating

### Shrouds

Temperature range		-55°C to +125°C
Housing material		PBT 30% glass filled
Flammability		UL 94 V-O

### Coding Keys

Temperature range		-55°C to +125°C
Housing material		Polycarbonate 30% glass filled
Flammability		UL 94 HB
Mechanical strength		≥ 300 Newtons (N)
Weight		0.3 Grams (G) average

### Latch Arm

Temperature range		-65°C to +125°C
Housing material		LCP 200 30% glass filled
Flammability		UL 94 V-O

### Cable Connectors

Female contact housing	Material	30% glass filled LCP
	Flammability	UL94VO
Over molding	Material	30% glass filled LCP
	Flammability	UL94VO
Locking combs	Material	30% glass filled LCP
Total weight of plastic material		1.0 grams
Shield	Material	phosphor bronze
	Plating	Gold plated
Contact	Material	phosphor bronze
	Plating	Gold plated

## Electrical And Mechanical Characters For Power Modules

	Standard	Male Power Module	Female Power Modul
<b>Technical Data</b>			
Climate Category	DIN EN 60068-1 test b	-55/125/56	-55/125/56
Bearing and operating temperature area		-55/125 °C	-55/125 °C
Current rating	IEC 60512 test 5b	By ambient temperature: 20 °C 9.0 A 70 °C 7.0 A 100 °C 4.5 A	By ambient temperature: 20 °C 9.0 A 70 °C 7.0 A 100 °C 4.5 A
Air- and creepage distance		2.6 mm	2.6 mm
Comperative figur of voltage	IEC 112	CTI-275	CTI-275
Voltage rating	DIN VDE 0110	Has to be determined according to client-specific using case (degree of environmental pollution) according to VDE 0110	Has to be determined according to client-specific using case (degree of environmental pollution) according to VDE 0110
Dielectric strength	IEC 60512 test 4a	contact – contact 1000 V	contact – contact 1000 V
Contact resistance	IEC 60512 test 2a	< 15 mΩ	< 15 mΩ
Insulation resistance	IEC 60512 test 3a	> 10 <sup>4</sup> MΩ	> 10 <sup>4</sup> MΩ
Vibration	IEC 60512 test 6d	10 – 2000 Hz 20 g	10 – 2000 Hz 20 g
Contact disturbance (while vibration shine)	IEC 60512 test 2e	< 1 μs	< 1 μs
Shock halvesine	IEC 60512 test 6c	50 g 11 ms	50 g 11 ms
Contact disturbance (while shock halvesine)	IEC 60512 test 2e	< 1 μs	< 1 μs
Mechanical operation 207 standard (mating cycles)	IEC 60512 test 9a	> 250	> 250
Insertion and withdrawal force	IEC 60512 test 13b	4 N max.	4 N max.
Gauge retention force	IEC 60512 test 16e	0.20 N min.	0.20 N min.
<b>Process-conditions</b>			
Warning		soldering of press-fit connectors not to be recommended	soldering of press-fit connectors not to be recommended

## Electrical And Mechanical Characters For Power Modules

	<b>Standard</b>	<b>Male Power Module</b>	<b>Female Power Modul</b>
<b>Materials</b>			
Housing: plastic material (symbol)		PBT	PBT
CTI value	IEC 112	CTI 275	CTI 275
UL flam rating		UL 94 V-0	UL 94 V-0
<b>Contact and mating area</b>			
Base material		Cu-alloy	Cu-alloy
Plating		Gold plated	Gold plated
<b>Termination area</b>			
Base material		Cu-alloy	Cu-alloy
Plating		Sn	Sn
<b>Environment compatibility</b>			
recycling		no flame-retardent additives, no toxic additives allow easy recycling	
<b>Product-licenses and customer specified tests</b>			
UL		in preparation	in preparation
CSA		in preparation	in preparation

## 7-Row Electrical Performance

The ERmet line of 2mm H.M. connectors set a new, higher standard for 2.0 mm electrical performance. A collection of test reports is available which completely characterizes the connectors' mechanical and high frequency performance. In addition, ERNI can provide a SPICE (Simulator Program for Integrated Circuit Emulation) model to customers, utilizing advanced circuit simulation methods.

In the Time Domain Reflectometry (TDR) plot shown below, note the connector exhibits an almost ideal, 50 ohm characteristic impedance. This smooth, discontinuity-free, impedance progression is due, in part, to both the uniform contact spacing and constant cross section, as well as the uniform dielectric constant. This is a result of the encapsulated terminals of the right angle female connector.

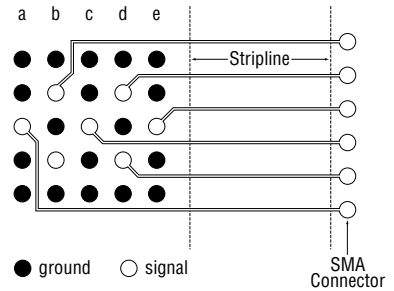
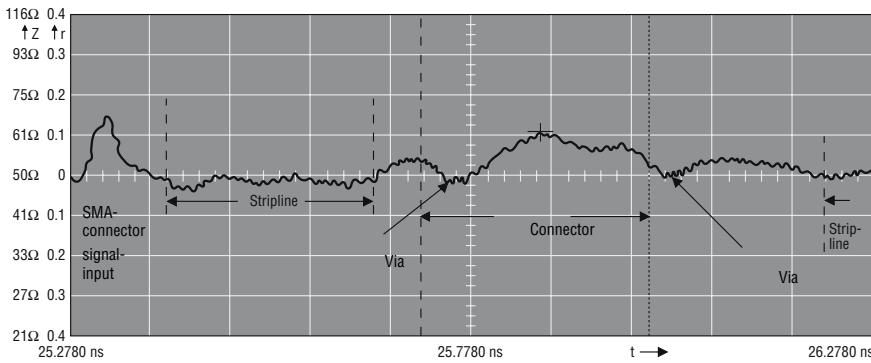

TDR plot showing the impedance progression from a 2mm H.M. connector. Signal ground pattern as shown.

## High Frequency Characteristics

The chart below summarizes the electrical characteristics of a test board with similar pin assignments. Note the remarkably low propagation delay (132 ps) and low total skew (a-e = 46 ps).

These factors, combined with the low capacitance and low inductance of the connector, make the ERmet 2mm H.M. Connector the best choice for demanding, high speed applications.

parameter	connector pin row				
	a	b	c	d	e
capacitance C (f = 100 MHz)	2.5 pF	2.8 pF	2.9 pF	3.1 pF	3.2 pF
inductance L (f = 100 MHz)	6.8 nH	7.6 nH	8.3 nH	8.7 nH	10.5 nH
characteristic impedance	52 Ω	52 Ω	53 Ω	53 Ω	57 Ω
propagation delay*	111 ps (86) ps	119 ps (94) ps	126 ps (101) ps	141 ps (116) ps	157 ps (132) ps
signal skew	8 ps   9 ps   14 ps   15 ps maximum 46 ps				
crosstalk (f = 100 MHz)	← 57 dB →		← 53 dB →		
Reflection factor (50 Ω and f = 100 MHz)	0.02	0.02	0.03	0.03	0.065
VSWR (f = 100 MHz)	1.04	1.04	1.06	1.06	1.14
Reflection loss [dB] (f = 100 MHz)	34	34	30.5	30.5	24

\* The higher value of the propagation delay is measured from solder-side to solder-side (rear side). The value in parenthesis is calculated from component-side to component-side (front side).

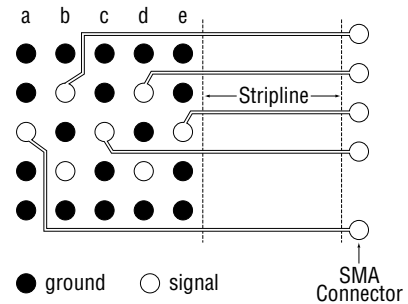

The measurement values are based on this pin configuration.



## 7-Row Electrical Performance

The specifications for contact current rating, dielectric withstanding voltages and creepage and clearance distances are all dependent on the contact loading configuration. For example, if contacts are loaded in a “chessboard pattern,” each contact can carry more current than if every contact is loaded.

**Current Rating For Various Contact Mounting Configurations**

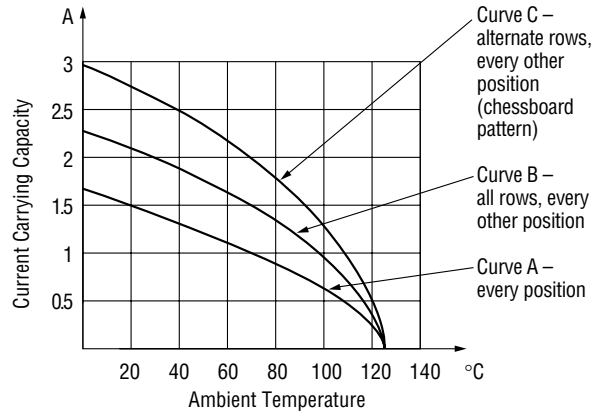

Dielectric Withstanding Voltage				
Contact/Contact:				
Row Designation		Fully Loaded	Every Other Position	Chessboard Pattern
Row a + c + e	Within the row	750V <sub>eff</sub>	1500V <sub>eff</sub>	–
Row b + d	Between the rows	1500V <sub>eff</sub>	1500V <sub>eff</sub>	–
Row a + b + c	Within the row	750V <sub>eff</sub>	1500V <sub>eff</sub>	1500V <sub>eff</sub>
Row a + b + c + d	Between the rows	750V <sub>eff</sub>	750V <sub>eff</sub>	1200V <sub>eff</sub>
Row a + b + c + d + e				
Contact to grounding rows or shielding frame: 750V <sub>eff</sub>				

Creepage Distances And Clearances Dependent On Contact Layout							
Contact/Contact:							
Row Designation		Fully Loaded		Every Other Position		Chessboard Pattern	
		Backplane Male Connector	Daughter Card Female Connector	Backplane Male Connector	Daughter Card Female Connector	Backplane Male Connector	Daughter Card Female Connector
Row a + c + e	Within the row	0.8	0.6	2.5	2.5	–	–
Row b + d	Between the rows	2.5	2.5	2.5	2.5	–	–
Row a + b + c	Within the row	0.8	0.6	2.5	2.5	2.5	2.5
Row a + b + c + d	Between the rows	0.8	0.6	0.8	0.6	1.5	1.2
Row a + b + c + d + e							
Creepage and clearance distances for contacts in the outer contact rows (A and E) to shielding rows (optional) is 0.8 mm.							

## 10-Row Electrical Performance

The ERmet line of 2mm H.M. connectors set a new, higher standard for 2.0 mm electrical performance. A collection of test reports is available which completely characterizes the connectors' mechanical and high frequency performance. In addition, ERNI can provide a SPICE (Simulator Program for Integrated Circuit Emulation) model to customers, utilizing advanced circuit simulation methods.

In the Time Domain Reflectometry (TDR) plot shown below, note the connector exhibits an almost ideal, 50 ohm characteristic impedance. This smooth, discontinuity-free, impedance progression is due, in part, to both the uniform contact spacing and constant cross section, as well as the uniform dielectric constant. This is a result of the encapsulated terminals of the right angle female connector.

## High Frequency Characteristics

The chart below summarizes the electrical characteristics of a test board with similar pin assignments.

low inductance of the connector, make the ERmet 2mm H.M. Connector the best choice for demanding, high speed applications.

These factors, combined with the low capacitance and

parameter	connection pin row							
	a	b	c	d	e	f	g	h
capacitance C [pF] f = 300 MHz	1.9	2.3	2.5	2.7	2.8	2.8	3.7	4.0
inductance L [nH] f = 100 MHz	5.4	6.3	6.9	7.5	8.1	8.9	11.9	15.5
characteristic impedance $z = \sqrt{L/C}$	53	52	53	53	54	56	57	62
propagation delay [ps]	110	120	130	140	150	160	175	190
signal skew [ps]	10		10		10		15	
	10			10			15	
crosstalk [dB] f=300 MHz	34.9		32.7		30.2		-28.61	
Reflection factor 50 Ohm f = 300 MHz	0.03	0.02	0.02	0.03	0.04	0.06	0.06	0.11
VSWR f = 300 MHz	1.06	1.04	1.04	1.06	1.08	1.13	1.13	1.25
Reflection loss [dB] f = 300 MHz	30.5	34.0	34.0	30.5	28.0	24.4	24.4	19.2

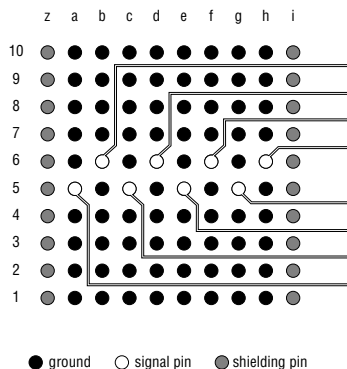

The measurement values are based on this pin configuration.

## 10-Row Electrical Performance

The specifications for contact current rating, dielectric withstanding voltages and creepage and clearance distances are all dependent on the contact loading configuration. For example, if contacts are loaded in a “chessboard pattern,” each contact can carry more current than if every contact is loaded.

**Current Rating For Various Contact Mounting Configurations**

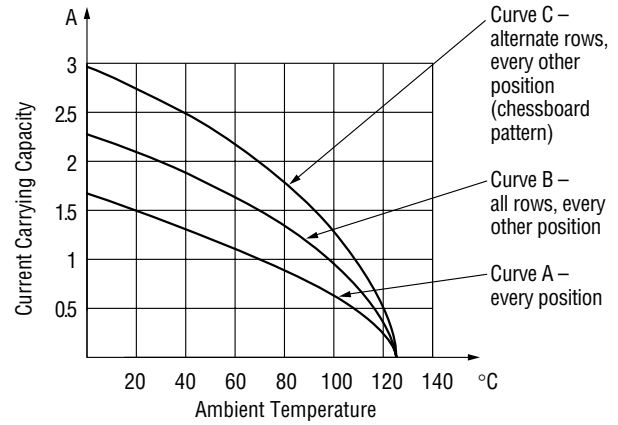

Dielectric Withstanding Voltage				
Contact/Contact:				
Row Designation		Fully Loaded	Every Other Position	Chessboard Pattern
Row a+c+e+g	Within the row	750V <sub>eff</sub>	1500V <sub>eff</sub>	–
Row b+d+f+h	Between the rows	1500V <sub>eff</sub>	1500V <sub>eff</sub>	–
Row a+b+c	Within the row	750V <sub>eff</sub>	1500V <sub>eff</sub>	1500V <sub>eff</sub>
Row a+b+c+d				
Row a+b+c+d+e				
Row a+b+c+d+e+f	Between the rows	750V <sub>eff</sub>	750V <sub>eff</sub>	1200V <sub>eff</sub>
Row a+b+c+d+e+f+g				
Row a+b+c+d+e+f+g+h				
Contact to grounding rows or shielding frame: 750V <sub>eff</sub>				

Creepage Distances And Clearances Dependent On Contact Layout							
Contact/Contact:							
Row Designation		Fully Loaded		Every Other Position		Chessboard Pattern	
		Backplane Male Connector	Daughter Card Female Connector	Backplane Male Connector	Daughter Card Female Connector	Backplane Male Connector	Daughter Card Female Connector
Row a+c+e+g	Within the row	0.8	0.6	2.5	2.5	–	–
Row b+d+f+h	Between the rows	2.5	2.5	2.5	2.5	–	–
Row a+b+c	Within the row	0.8	0.6	2.5	2.5	2.5	2.5
Row a+b+c+d							
Row a+b+c+d+e							
Row a+b+c+d+e+f	Between the rows	0.8	0.6	0.8	0.6	1.5	1.2
Row a+b+c+d+e+f+g							
Row a+b+c+d+e+f+g+h							
Creepage and clearance distances for contacts in the outer contact rows (A and E) to shielding rows (optional) is 0.8 mm.							

## Approval Certificates, Performance Levels And Ordering Information

### Approval Certificates

**UL** Approved by the American approvals authority (Underwriters Laboratories Inc.) File number E 84703.

**CSA** Tested and found in compliance with the requirements of the Canadian Standards Association (CSA). File numbers LR 62504.

**ISO 9001** All ERmet connectors are designed and produced in fully approved ERNI ISO 9001 facilities.

**Bellcore GR 1217 CORE** ERmet connectors are available that meet the requirements of Bellcore GR-1217-CORE for large systems in uncontrolled environments.

**ECTF** ERmet connectors are also available to meet the requirements of the Enterprise Computer Telephony Forum's (ECTF) H.110 specification.

**IEC 917 And IEC 61076-4-101** The ERmet Connector System meets the requirements of IEC 61076-4-101 which was developed in accordance with the requirements of IEC 917 the standard for for Hard Metric mounting systems.

**IEEE 1301 And IEEE 1101 And IEEE 1101.10** ERmet connectors were developed to meet the demanding board to backplane physical architecture of IEEE 1301 and have been adapted to meet the requirements of IEEE 1101 and IEEE 1101.10.

**PICMG** ERmet connectors have been adapted to meet the requirements of the CompactPCI specification as defined by the PICMG. Special length connectors with the required loading have been molded and assembled for these applications. Type AB connectors have been developed for rear transition card applications.

### Performance Levels

207 Conforms to the requirements of IEC 61076-4-101 performance level 2 ( $\geq 250$  mating cycles) in the contact area.

For detailed information, see Mechanical Specifications and Performance.

201 Conforms to the requirements of IEC 61076-4-101 performance level 2 ( $\geq 250$  mating cycles) in both contact and terminal areas.

For additional performance levels, consult ERNI Customer Service.

### Ordering Information

All ERNI ERmet 2mm H.M. Connectors for CompactPCI and VME64 Extensions are assigned a six digit part number. The following pages contain part numbers, along with product descriptions of many popular ERNI 2mm H.M. Connectors, complementary components, application, repair and installation tooling. In addition to the configurations listed in this catalog, others are available. Please consult ERNI customer service for more information.

## Right Angle Female Connectors Type A For Daughter Cards

110 signal contacts  
50 mm with multifunction block (for positioning and coding)

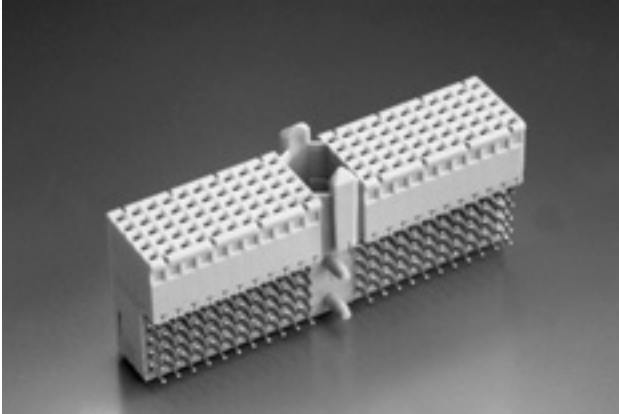

The ERmet type A female connector provides 110 contacts in a 5 row x 25 position (3 positions used by multifunction cavity), fully loaded configuration. This connector is used in the J1 and J4 positions of the CompactPCI® daughter card. The connector is designed for gas tight, pressfit installation and is provided in two different configurations: with integrated upper ground return shields and without integrated upper ground return shields. Lower ground return shields are available separately.

The ERmet type A female connector has a multifunction cavity that incorporates pre-alignment guides and accepts optional coding keys. This connector is designed to be used alone or in conjunction with either a type B, C, L, M or N ERmet connector. The type A female is also available with a locating and strain relief peg that helps secure the connector to the printed circuit board (PCB).

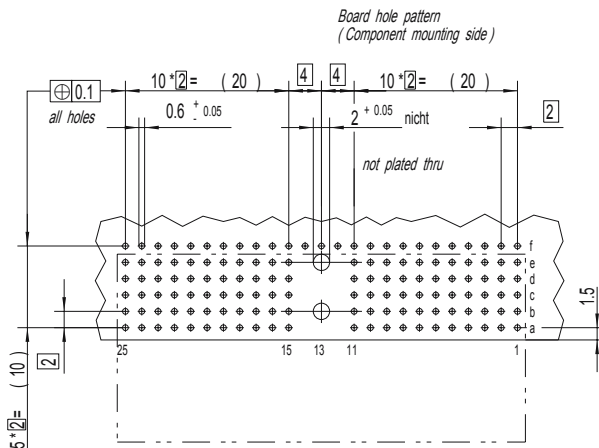
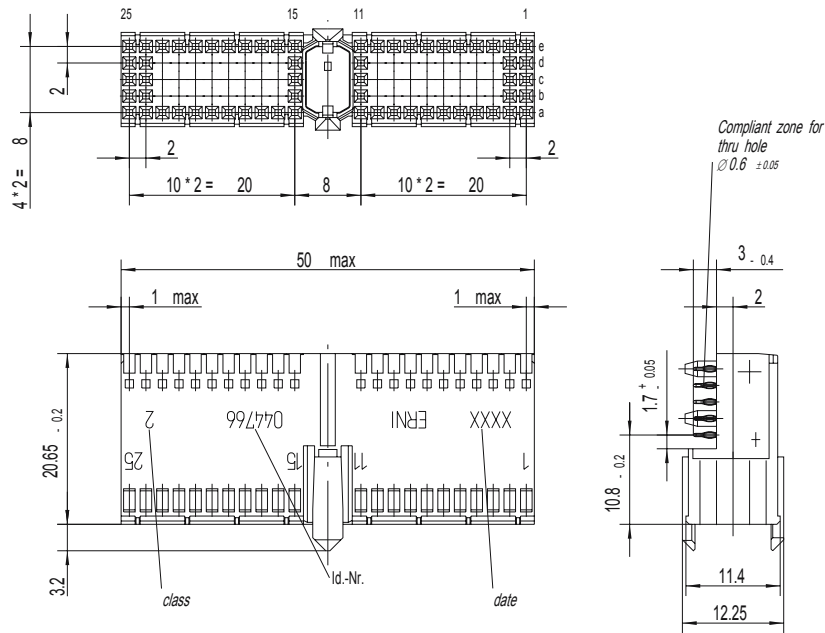

### Dimensional drawings and board hole pattern



Note: The numbering on the connectors themselves is in accordance with the IEC 61076-4-101 standard. All dimensions in mm.

# Right Angle Female Connectors Type A For Daughter Cards

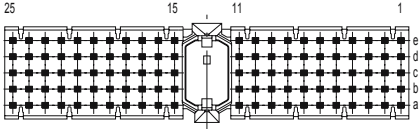
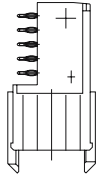
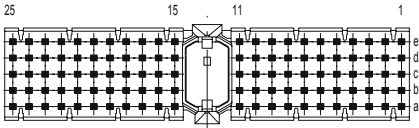
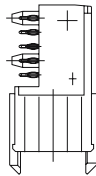
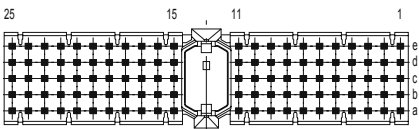
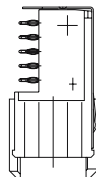
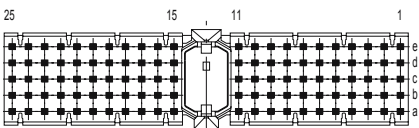
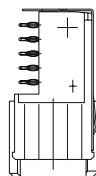
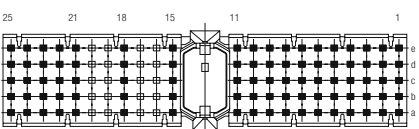
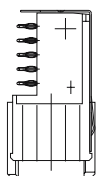
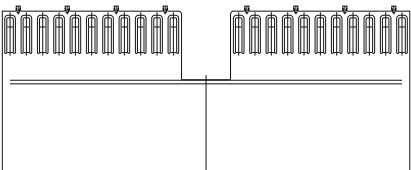
## Ordering Information

Configuration	Used For	No. of Pins	Part Number
Type A Without Shield, Without Peg  	<b>CompactPCI™</b> J1, J4	110	<b>044146</b>
Type A Without Shield, With Peg  		110	<b>044766</b>
Type A With Shield, Without Peg  	<b>CompactPCI™</b> J1, J4	110	<b>064176</b>
Type A With Split Shield, Partially Loaded  	<b>ECTF™</b> J4 Telecom	80	<b>104512</b>
Type A With Split Shield, Partially Loaded  	<b>ECTF™</b> rJ4 Telecom	80	<b>104697</b>
Lower Shield For Type A And AB  	<b>CompactPCI™</b> J1, J4		

# Vertical Male Connectors Type A For Backplanes

110 signal contacts  
50 mm with multifunction block (for positioning and coding)

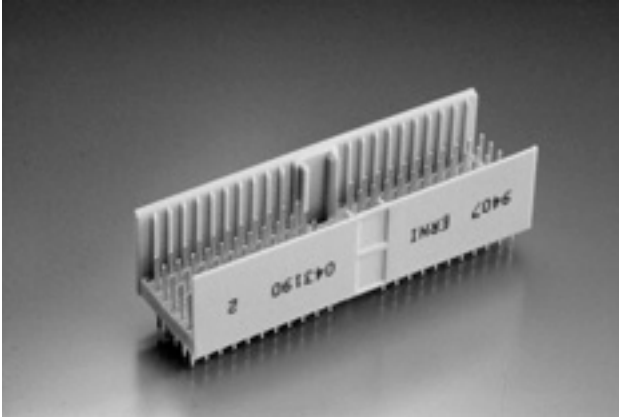

The ERmet type A vertical male connector provides 110 signal contacts and 44 ground shield contacts in 5+2 row x 25 position (3 positions used by multifunction cavity), fully loaded configuration. This connector is used in the P1 and P4 positions of a CompactPCI® backplane. With 15 different standard pin lengths to choose from, this is one of the most versatile connectors available. The connector is designed for gas tight pressfit installation.

The ERmet type A male connector has a multifunction cavity that incorporates pre-alignment guides and accepts optional coding keys. This connector is designed to be used alone or in conjunction with either type B, C, L, M or N ERmet connectors.

## Dimensional drawings and board hole pattern

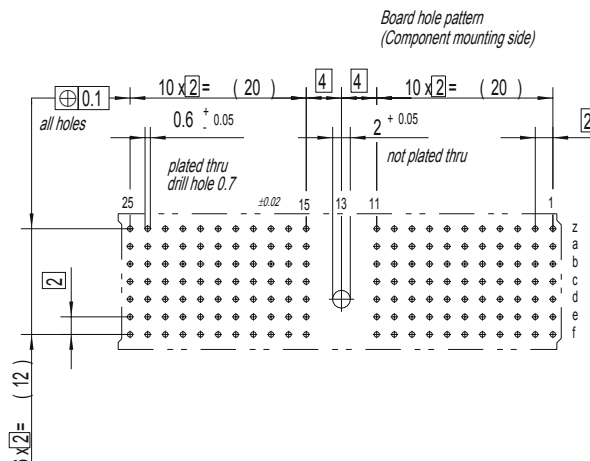
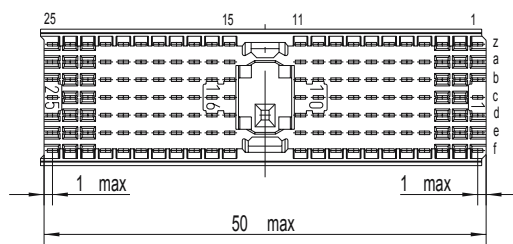
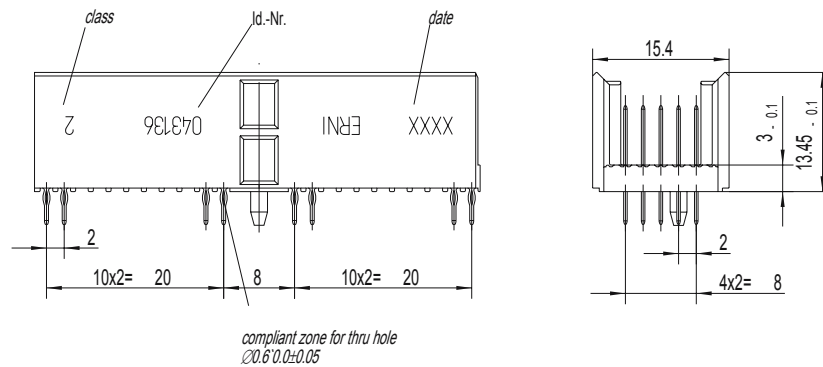

Note: The numbering on the connectors themselves is in accordance with the IEC 61076-4-101 standard. All dimensions in mm.

# Vertical Male Connectors Type A For Backplanes

## Ordering Information

Configuration	Used For	No. of Pins	Part Number
<p>Type A With Peg</p>		110	<b>043136</b>
<p>Type A With Peg</p>		110	<b>043190</b>
<p>Type A With Peg And Extended Terminals For Shrouding</p>		110	<b>043477</b>
<p>Type A Without Peg</p>		110	<b>044148</b>
<p>Type A With Peg</p>		110	<b>044149</b>

### Contact versions

ERNI can accommodate any pattern of male connector contact loading.

For shield rows z and f (7 row connectors) or z and y (10 row connectors), level 3 contacts should be specified. For rear I/O and shrouds, choose contacts with the R1, R2 or R3 terminal length. Each contact has a unique letter designation. Use this letter designation when filling in the contact loading requirements on the ERNI Customer Request Form.

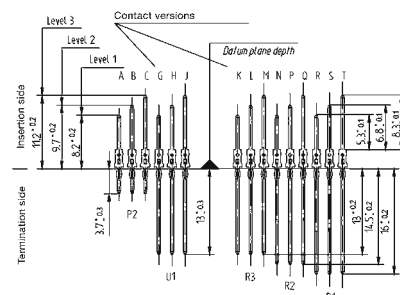



# Vertical Male Connectors Type A For Backplanes

## Ordering Information

Configuration	Used For	No. of Pins	Part Number
<p>Type A With Peg</p>		154	<b>053007</b>
<p>Type A With Peg And Extended Terminals For Shrouding</p>		154	<b>054034</b>
<p>Type A With Peg And Extended Terminals For Shrouding</p>		154	<b>054185</b>
<p>Type A With Peg</p>		154	<b>054528</b>
<p>Type A With Peg</p>	<p><b>CompactPCI™</b></p> <p>P1 Per PICMG 2.0 R2.1</p>	154	<b>064097</b>

### Contact versions

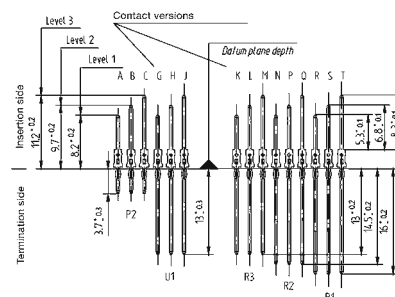

ERNI can accommodate any pattern of male connector contact loading.

For shield rows z and f (7 row connectors) or z and y (10 row connectors), level 3 contacts should be specified. For rear I/O and shrouds, choose contacts with the R1, R2 or R3 terminal length. Each contact has a unique letter designation. Use this letter designation when filling in the contact loading requirements on the ERNI Customer Request Form.

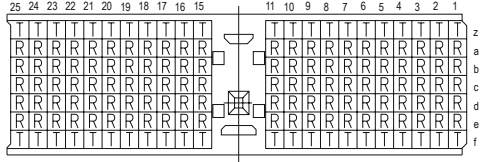
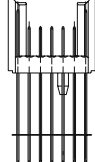
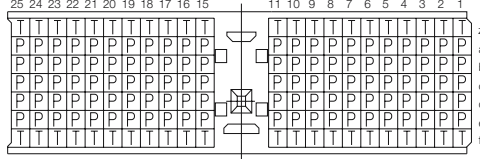
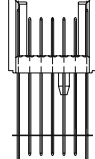
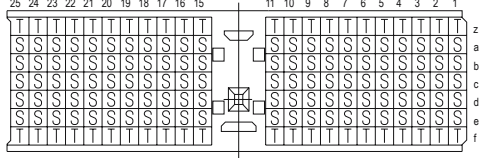
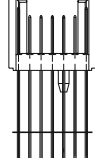
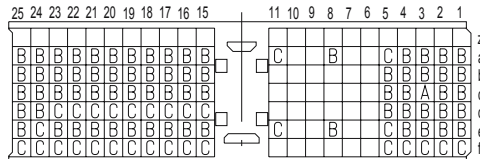

# Vertical Male Connectors Type A For Backplanes

## Ordering Information

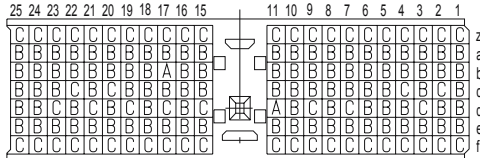
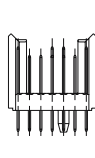
Configuration	Used For	No. of Pins	Part Number
Type A With Peg And Extended Terminals For Shrouding  	<b>CompactPCI™</b>  P4	154	<b>064688</b>
Type A With Peg And Extended Terminals For Shrouding  	<b>CompactPCI™</b>  P4	154	<b>103968</b>
Type A With Peg And Extended Terminals For Shrouding  	<b>CompactPCI™</b>  P4	154	<b>103975</b>
Type A Without Peg  	<b>ECTF™</b> <small>European Connector Technology Forum</small>  P4 Telecom	100	<b>923160</b>
Type A With Peg  	<b>CompactPCI™</b>  P1	154	<b>923190</b>

### Contact versions

ERNI can accommodate any pattern of male connector contact loading.

For shield rows z and f (7 row connectors) or z and y (10 row connectors), level 3 contacts should be specified. For rear I/O and shrouds, choose contacts with the R1, R2 or R3 terminal length. Each contact has a unique letter designation. Use this letter designation when filling in the contact loading requirements on the ERNI Customer Request Form.

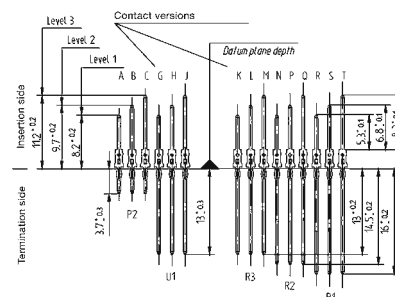

# Vertical Male Connectors Type A For Backplanes

## Ordering Information

Configuration	Used For	No. of Pins	Part Number	
Type A With Peg And Extended Terminals For Shrouding 	<b>CompactPCI™</b>	P1 Special	154	<b>923197</b>
Type A Without Peg And With Extended Terminals 	<b>ECTF™</b>	P4 Telecom	100	<b>923212</b>
Type A Without Peg And With Extended Terminals 	<b>CompactPCI™</b>	P1	154	<b>923342</b>
Type A With Extended Terminals For Shrouding 	<b>CompactPCI™</b>	P4	132	<b>923347</b>

### Contact versions

ERNI can accommodate any pattern of male connector contact loading.

For shield rows z and f (7 row connectors) or z and y (10 row connectors), level 3 contacts should be specified. For rear I/O and shrouds, choose contacts with the R1, R2 or R3 terminal length. Each contact has a unique letter designation. Use this letter designation when filling in the contact loading requirements on the ERNI Customer Request Form.

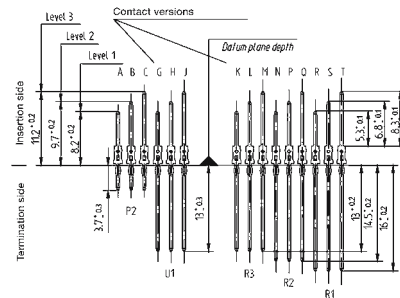

## Vertical Female Connectors Type A

110 signal contacts  
 50 mm with multifunction block (for positioning and coding)

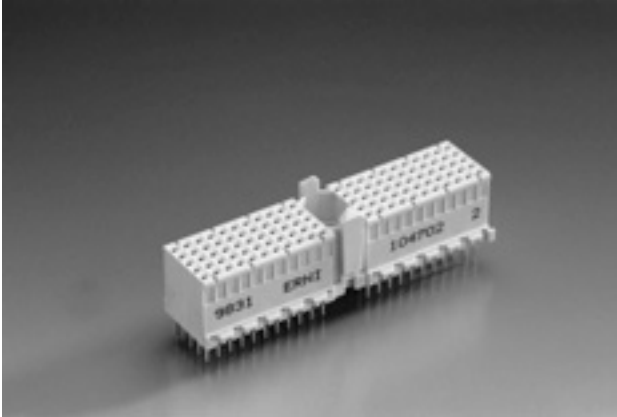

The ERmet type A vertical female connector provides 110 contacts in a 5 row x 22 position fully loaded configuration. Versions with optional “z” and “f” row shields are available as well as extended terminals for use in stacking applications with rear shrouds.

Two spacer heights are also available: 3.1 mm and 9.6 mm to provide additional component clearance.

The ERmet type A female connector has a multifunctional cavity that incorporates pre-alignment pins and optional coding keys. The pressfit terminals provide a convenient and reliable gas tight connection.

This connector may be used alone or in conjunction with Type B and C vertical female connectors.

### Dimensional drawings and board hole pattern

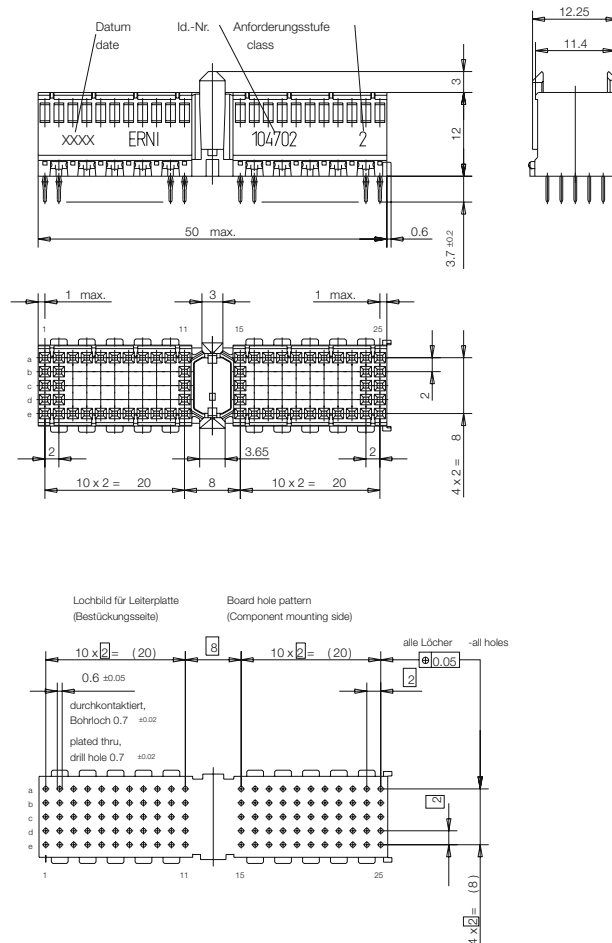

Note: The numbering on the connectors themselves is in accordance with the IEC 61076-4-101 standard. All dimensions in mm.

# Vertical Female Connectors Type A

## \* Termination + Board To Board Distance

### Version Without Shield

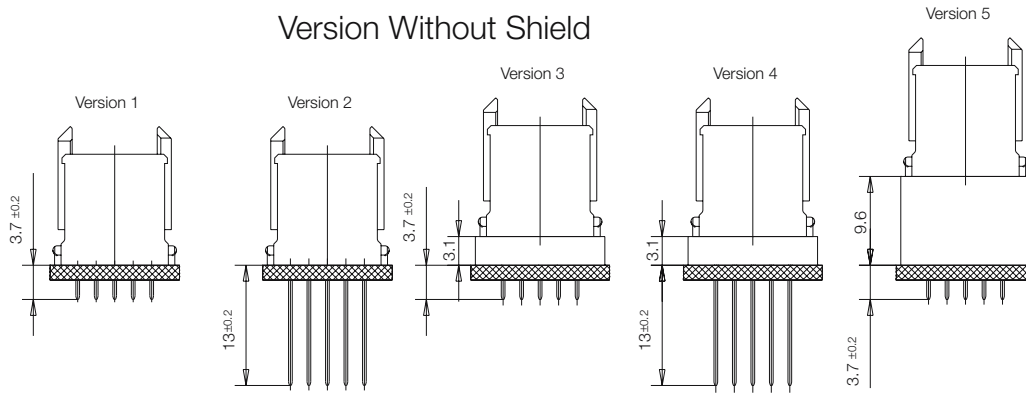

Version	Board To Board Distance *
1	15-16.5
2	15-16.5
3	18.4-20
4	18.4-20
5	25-26.5

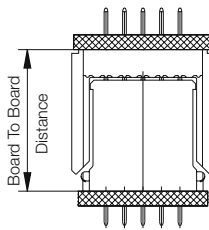

\* based on contact level 1  
 other board to board distances for remaining levels on request  
 (Please contact our Customer Service)

### Version With Shield

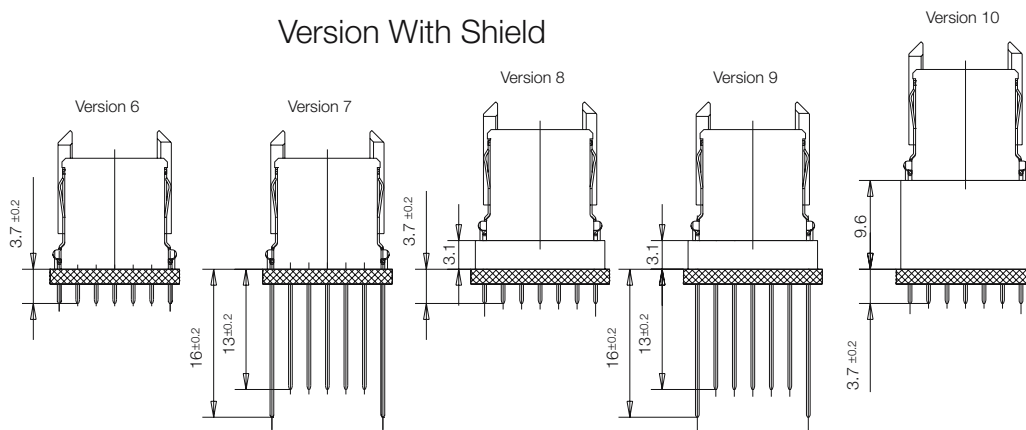

Version	Board To Board Distance *
6	15-16.5
7	15-16.5
8	18.4-20
9	18.4-20
10	25-26.5

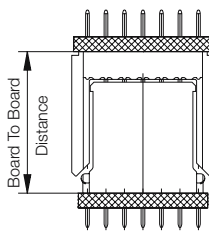

\* based on contact level 1  
 other board to board distances for remaining levels on request  
 (Please contact our Customer Service)

Note: All dimensions in mm.

## Vertical Female Connectors Type A

### Ordering Information

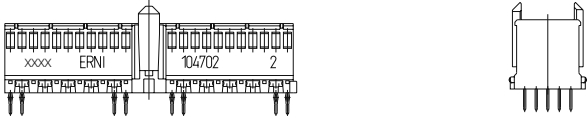
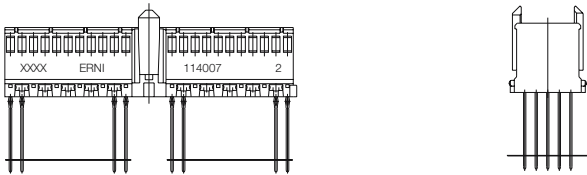
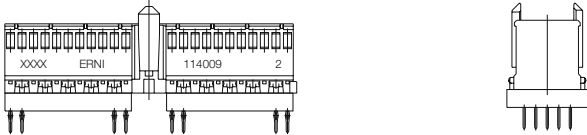
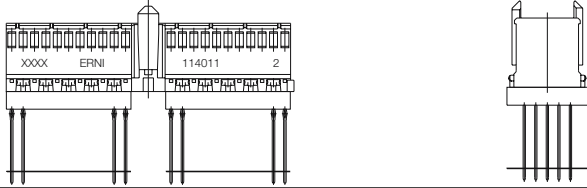
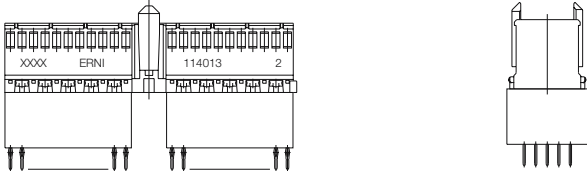
Configuration	Used For	No. of Pins	Part Number
Type A Without Shield, Without Peg Version 1 * 		110	<b>104702</b>
Type A Without Shield, Without Peg Version 2 * 		110	<b>114007</b>
Type A Without Shield, Without Peg Version 3 * 		110	<b>114009</b>
Type A Without Shield, Without Peg Version 4 * 		110	<b>114011</b>
Type A Without Shield, Without Peg Version 5 * 		110	<b>114013</b>

# Vertical Female Connectors Type A

## Ordering Information

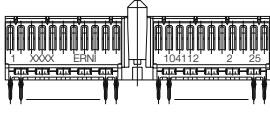
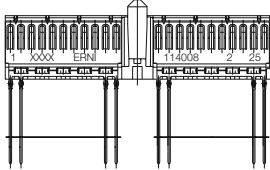
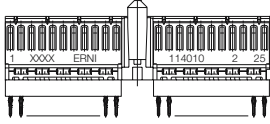
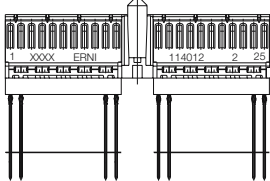
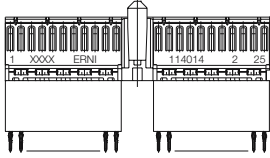
Configuration	Used For	No. of Pins	Part Number
Type A With Shield, Without Peg Version 6 * 		110	<b>104112</b>
Type A With Shield, Without Peg Version 7 * 		110	<b>114008</b>
Type A With Shield, Without Peg Version 8 * 		110	<b>114010</b>
Type A With Shield, Without Peg Version 9 * 		110	<b>114012</b>
Type A With Shield, Without Peg Version 10 * 		110	<b>114014</b>

## Right Angle Female Connectors Type B For Daughter Cards

125 signal contacts  
50 mm without multifunction block

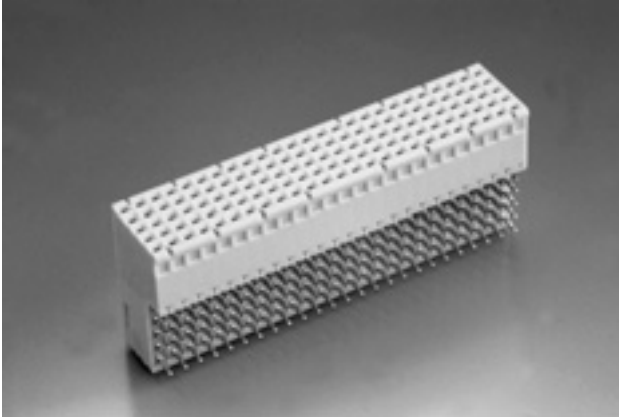

The ERmet type B female connector provides 125 contacts in a 5 row x 25 position fully loaded configuration.

The connector is designed for gas tight, pressfit installation and is provided in two different configurations: with integrated ground return shields and without integrated upper ground return shields. Lower ground return shields are available separately.

The ERmet type B female connector has an uninterrupted pin field with no multifunction cavity. This connector is not designed to be used alone, but is intended to be used in conjunction with either a type A, C, L, M or N ERmet connector.

### Dimensional drawings and board hole pattern

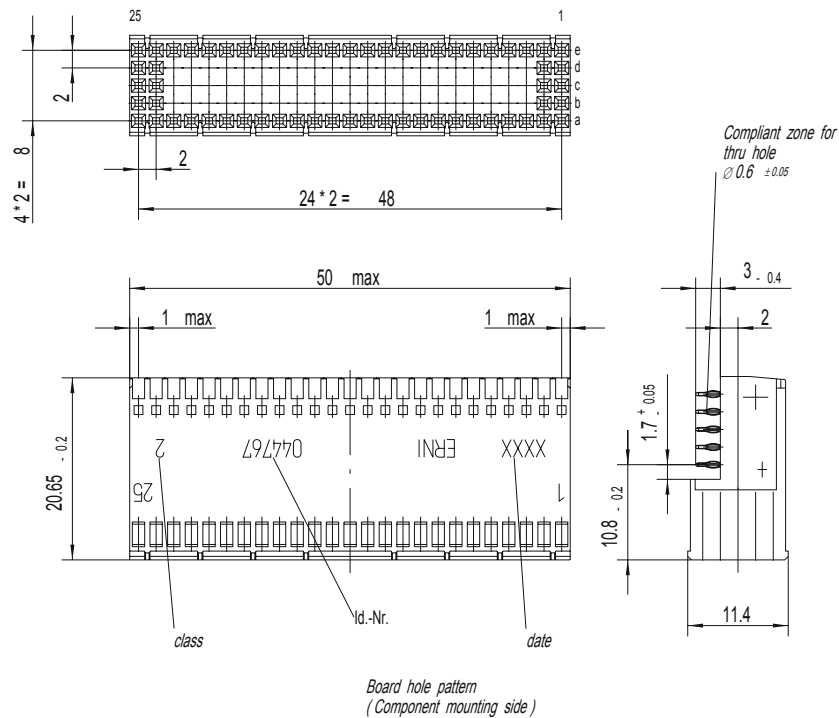

Note: The numbering on the connectors themselves is in accordance with the IEC 61076-4-101 standard. All dimensions in mm.



# Right Angle Female Connectors Type B For Daughter Cards

## Ordering Information

Configuration	Used For	No. of Pins	Part Number
Type B Without Shield, Without Peg 		125	<b>044767</b>
Type B With Upper Shield, Without Peg 		125	<b>064179</b>
Type B Without Shield, Without Peg 	<b>CompactPCI™</b> J2, J5	110	<b>914797</b>
Type B With Upper Shield 	<b>CompactPCI™</b> J2, J5	110	<b>064785</b>
Type B Without Shield, Without Peg 	<b>CompactPCI™</b> J3	95	<b>914794</b>
Type B With Upper Shield 	<b>CompactPCI™</b> J3	95	<b>064784</b>

## Right Angle Female Connectors Type B For Daughter Cards

### Ordering Information

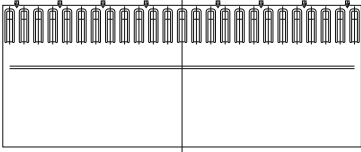
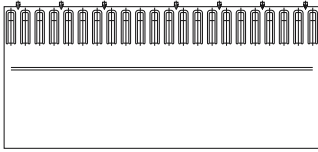
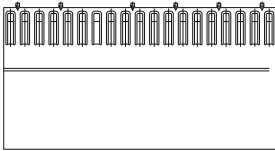
Configuration	Used For	No. of Pins	Part Number
Lower Shield For Type B 			044452
Lower Shield For Type B 	<b>CompactPCI™</b>	J2, J5	064783
Lower Shield For Type B 	<b>CompactPCI™</b>	J3	064782

## Vertical Male Connectors Type B For Backplanes

125 signal contacts  
50 mm without multifunction block

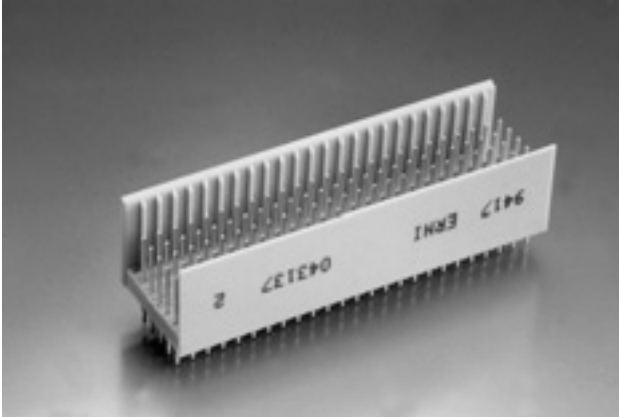

The ERmet CompactPCI type B vertical male connector provides 125 signal contacts and 50 ground shield contacts in a 5+2 row x 25, fully loaded configuration. With 15 different standard pin lengths to choose from, this is one of the most versatile connectors available. The connector is designed for gas tight pressfit installation.

The ERmet type B vertical male connector has an uninterrupted pin field with no multifunction cavity. This connector is not designed to be used alone, but it is intended to be used in conjunction with either a type A, C, L, M or N ERmet connector.

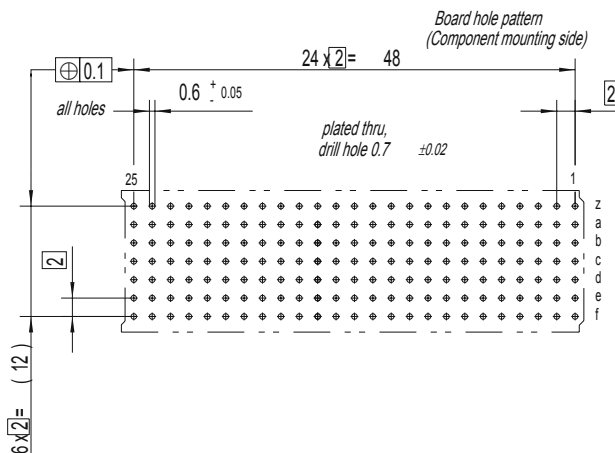
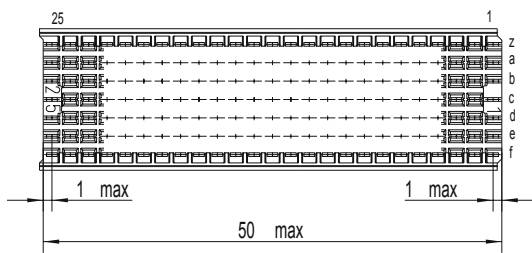
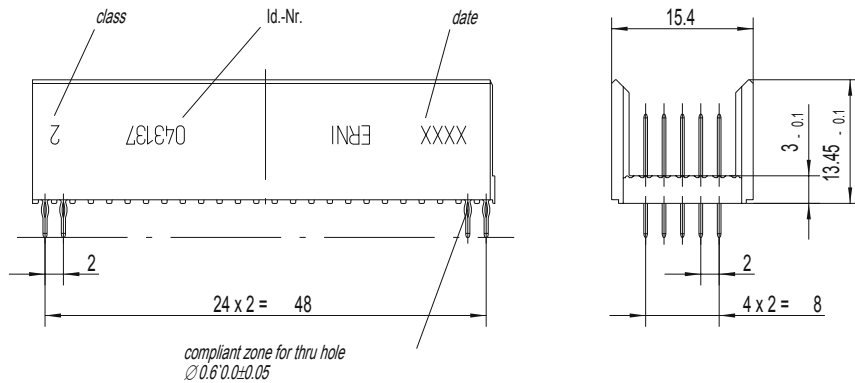

### Dimensional drawings and board hole pattern



Note: The numbering on the connectors themselves is in accordance with the IEC 61076-4-101 standard. All dimensions in mm.

# Vertical Male Connectors Type B For Backplanes

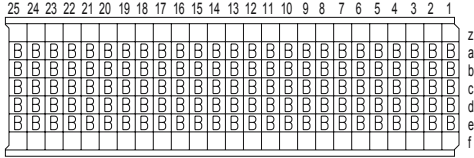
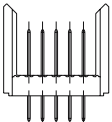
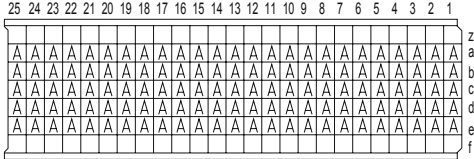
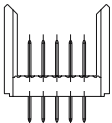
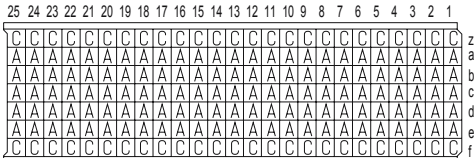
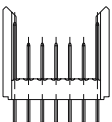
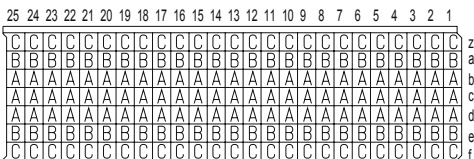
## Ordering Information

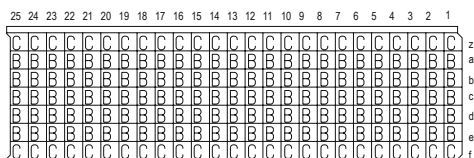
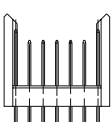
Configuration	Used For	No. of Pins	Part Number
Type B 		125	<b>043137</b>
Type B 		125	<b>053088</b>
Type B 		175	<b>053008</b>
Type B 		175	<b>054293</b>
Type B 		175	<b>054392</b>

### Contact versions

ERNI can accommodate any pattern of male connector contact loading.

For shield rows z and f (7 row connectors) or z and y (10 row connectors), level 3 contacts should be specified. For rear I/O and shrouds, choose contacts with the R1, R2 or R3 terminal length. Each contact has a unique letter designation. Use this letter designation when filling in the contact loading requirements on the ERNI Customer Request Form.

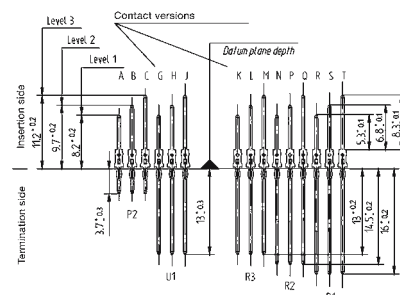

# Vertical Male Connectors Type B For Backplanes

## Ordering Information

Configuration	Used For	No. of Pins	Part Number	
<p>Type B With Extended Terminals</p>		125	<b>043476</b>	
<p>Type B With Extended Terminals</p>		175	<b>054186</b>	
<p>Type B With Extended Terminals</p>		175	<b>064522</b>	
<p>Type B</p>	<b>CompactPCI™</b>	P2, P5	154	<b>914796</b>
<p>Type B</p>	<b>ECTF™</b> <small>European Connector Technology Forum</small>	P5 Telecom	154	<b>923162</b>

### Contact versions

ERNI can accommodate any pattern of male connector contact loading.

For shield rows z and f (7 row connectors) or z and y (10 row connectors), level 3 contacts should be specified. For rear I/O and shrouds, choose contacts with the R1, R2 or R3 terminal length. Each contact has a unique letter designation. Use this letter designation when filling in the contact loading requirements on the ERNI Customer Request Form.

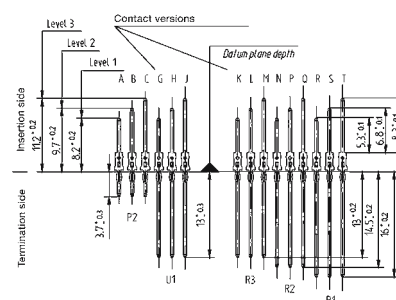

# Vertical Male Connectors Type B For Backplanes

## Ordering Information

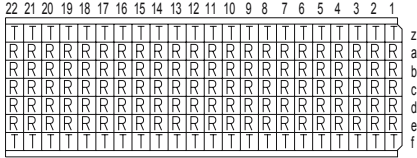
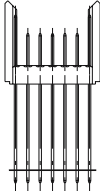
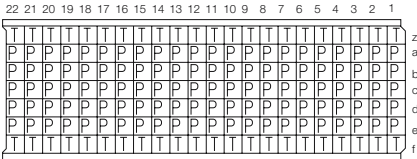
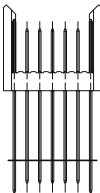
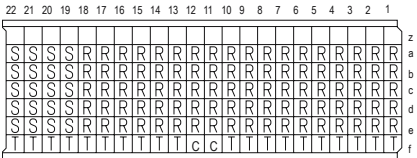
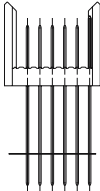
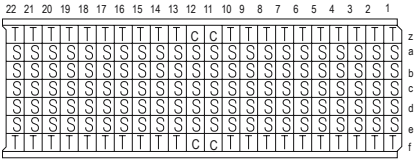
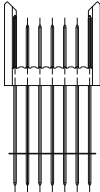
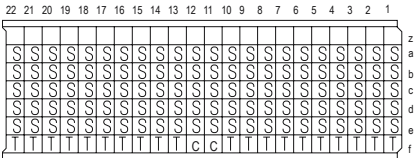
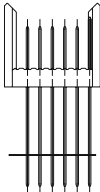
Configuration	Used For	No. of Pins	Part Number
Type B With Extended Terminals  	<b>CompactPCI™</b>  P2, P5	154	<b>064690</b>
Type B With Extended Terminals For Shrouding  	<b>CompactPCI™</b>  P2	154	<b>923131</b>
Type B (AB Compatible) With Extended Terminals For Shrouding  	<b>ECTF™</b> <small>Enhanced Connector Technology Form</small>  P5 Telecom	132	<b>923339</b>
Type B (AB Compatible) With Extended Terminals For Shrouding  	<b>CompactPCI™</b>  P2	154	<b>923340</b>
Type B (AB Compatible) With Extended Terminals For Shrouding  	<b>CompactPCI™</b>  P2	132	<b>923345</b>

### Contact versions

ERNI can accommodate any pattern of male connector contact loading.

For shield rows z and f (7 row connectors) or z and y (10 row connectors), level 3 contacts should be specified. For rear I/O and shrouds, choose contacts with the R1, R2 or R3 terminal length. Each contact has a unique letter designation. Use this letter designation when filling in the contact loading requirements on the ERNI Customer Request Form.

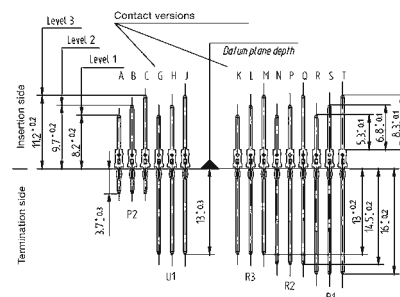

# Vertical Male Connectors Type B For Backplanes

## Ordering Information

Configuration	Used For	No. of Pins	Part Number	
<p>Type B</p>	<b>CompactPCI™</b>	P3	133	<b>103670</b>
<p>Type B With Extended Terminals</p>	<b>CompactPCI™</b>	P3	133	<b>914793</b>
<p>Type B With Extended Terminals For Shrouding</p>	<b>CompactPCI™</b>	P3	133	<b>923132</b>
<p>Type B (AB Compatible) With Extended Terminals For Shrouding</p>	<b>CompactPCI™</b>	P3	133	<b>923341</b>
<p>Type B (AB Compatible) With Extended Terminals For Shrouding</p>	<b>CompactPCI™</b>	P3	114	<b>923346</b>

### Contact versions

ERNI can accommodate any pattern of male connector contact loading.

For shield rows z and f (7 row connectors) or z and y (10 row connectors), level 3 contacts should be specified. For rear I/O and shrouds, choose contacts with the R1, R2 or R3 terminal length. Each contact has a unique letter designation. Use this letter designation when filling in the contact loading requirements on the ERNI Customer Request Form.

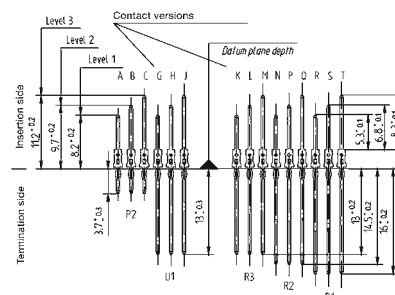

# Vertical Male Connectors Type B For Backplanes

## Ordering Information

Configuration	Used For	No. of Pins	Part Number
Type B		112	064766

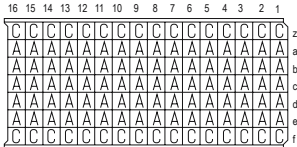

### Contact versions

ERNI can accommodate any pattern of male connector contact loading. For shield rows z and f (7 row connectors) or z and y (10 row connectors), level 3 contacts should be specified. For rear I/O and shrouds, choose contacts with the R1, R2 or R3 terminal length. Each contact has a unique letter designation. Use this letter designation when filling in the contact loading requirements on the ERNI Customer Request Form.

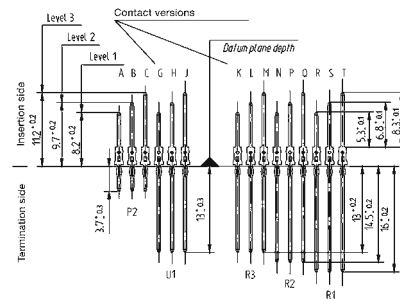



# Vertical Female Connectors Type B

125 signal contacts  
50 mm without multifunction block

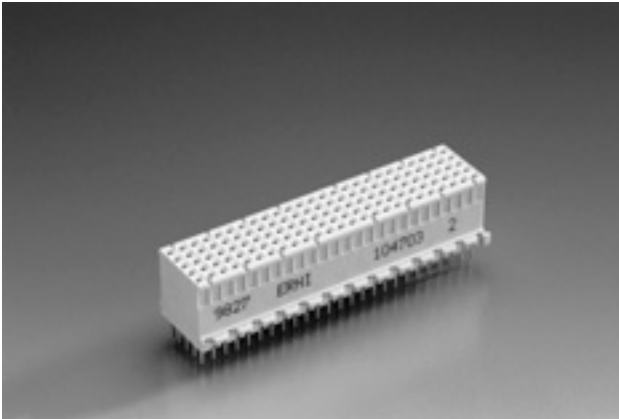

The ERmet type B vertical female connector provides 125 contacts in a 5 row x 25 position fully loaded configuration. Versions with optional “z” and “f” row shields are available as well as extended terminals for use in stacking applications with rear shrouds.

Two spacer heights are also available: 3.1 mm and 9.6 mm to provide additional component clearance.

The ERmet type B vertical female connector has an uninterrupted contact field and no multifunction cavity. This connector is not designed to be used alone, but is intended to be used with either a Type A or C female ERmet connector.

## Dimensional drawings and board hole pattern

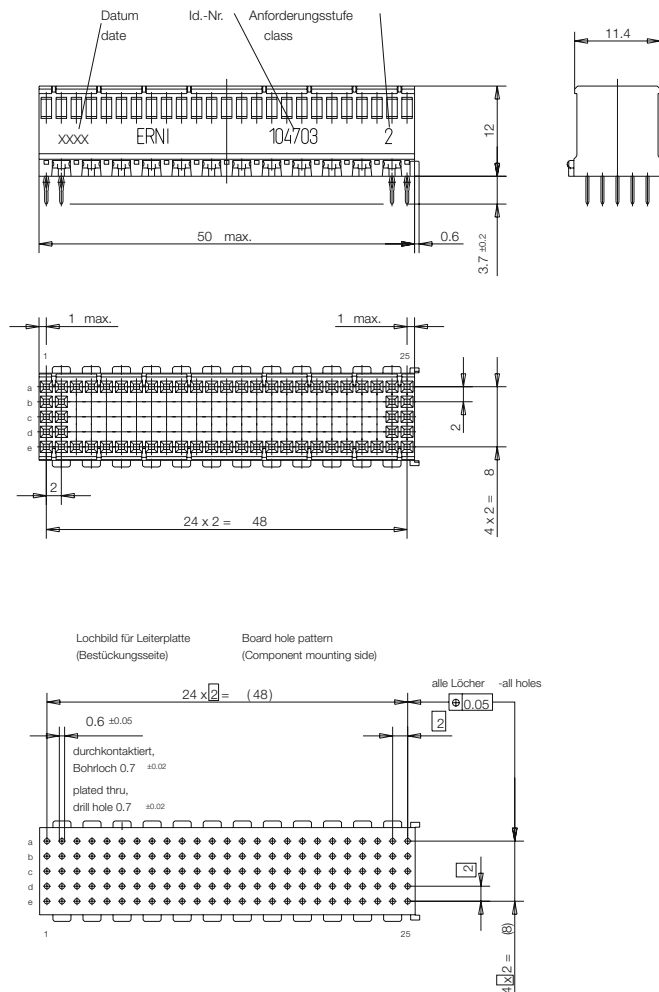

Note: The numbering on the connectors themselves is in accordance with the IEC 61076-4-101 standard. All dimensions in mm.

# Vertical Female Connectors Type B

## \* Termination + Board To Board Distance

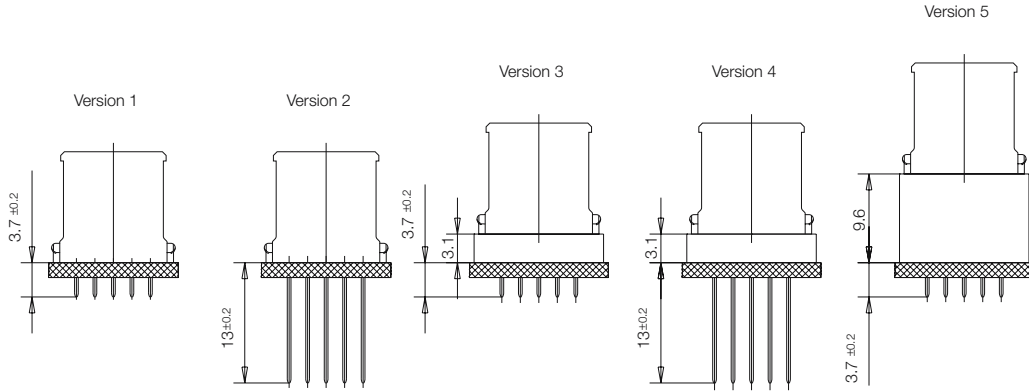

Version	Board To Board Distance *
1	15-16.5
2	15-16.5
3	18.4-20.0
4	18.4-20.0
5	25-26.5

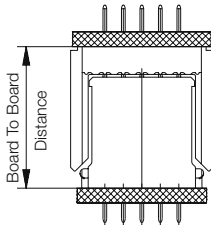

\* based on contact level 1  
 other board to board distances for remaining levels on request  
 (Please contact our Customer Service)

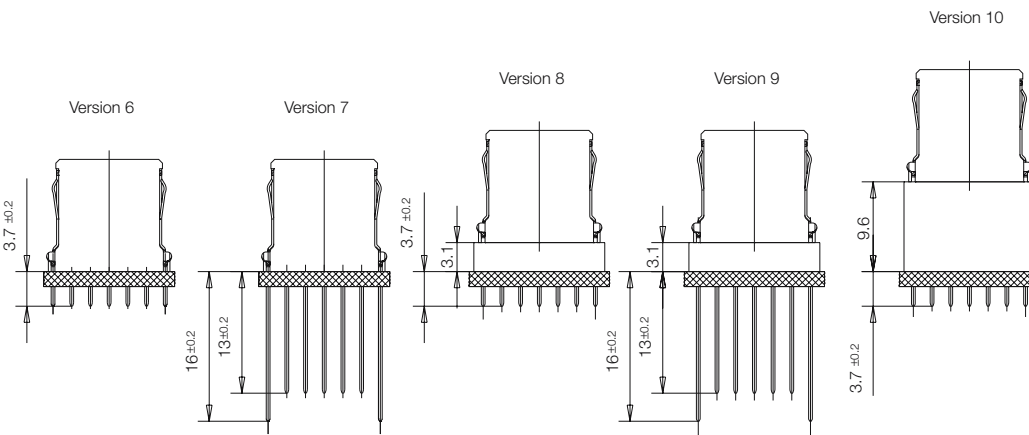

Version	Board To Board Distance *
6	15-16.5
7	15-16.5
8	18.4-20.0
9	18.4-20.0
10	25-26.5

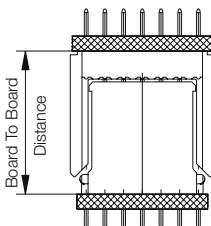

\* based on contact level 1  
 other board to board distances for remaining levels on request  
 (Please contact our Customer Service)

Note: All dimensions in mm.

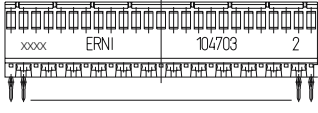
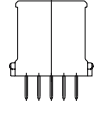
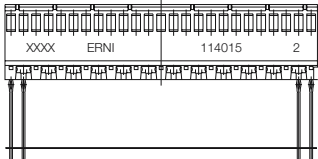
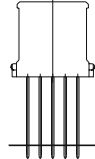
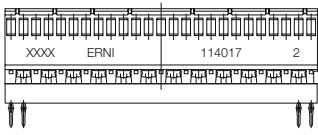
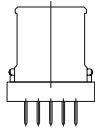
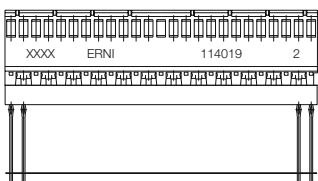
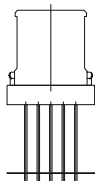
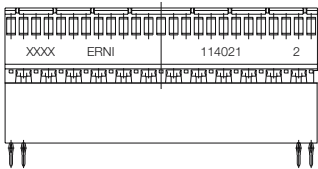
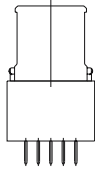

## Vertical Female Connectors Type B

### Ordering Information

Configuration	Used For	No. of Pins	Part Number
Type B Without Shield, Without Peg Version 1 *  		125	<b>104703</b>
Type B Without Shield, Without Peg Version 2 *  		125	<b>114015</b>
Type B Without Shield, Without Peg Version 3 *  		125	<b>114017</b>
Type B Without Shield, Without Peg Version 4 *  		125	<b>114019</b>
Type B Without Shield, Without Peg Version 5 *  		125	<b>114021</b>



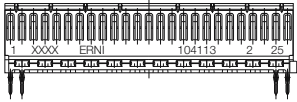
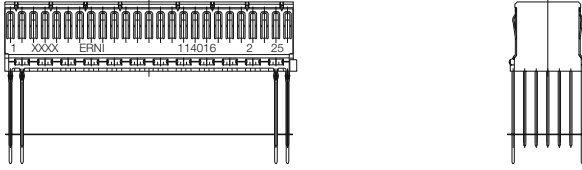
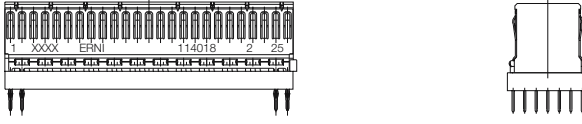
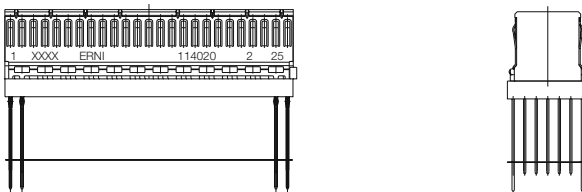
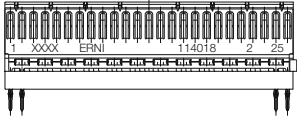
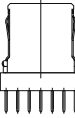
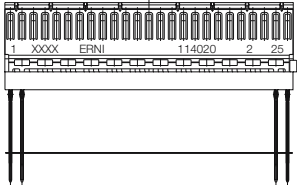

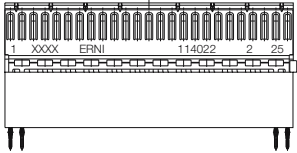
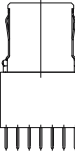

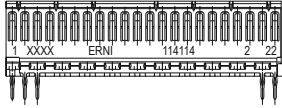

## Vertical Female Connectors Type B

### Ordering Information

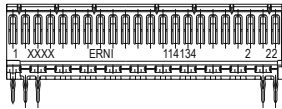
Configuration	Used For	No. of Pins	Part Number
Type B With Shield, Without Peg Version 6 *  		125	<b>104113</b>
Type B With Shield, Without Peg Version 7 *  		125	<b>114016</b>
Type B With Shield, Without Peg Version 8 *  		125	<b>114018</b>
Type B With Shield, Without Peg Version 9 *  		125	<b>114020</b>
Type B With Shield, Without Peg Version 10 *  		125	<b>114022</b>

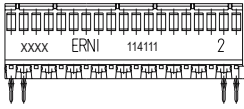
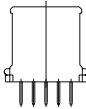
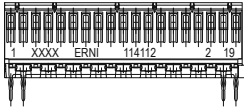
## Vertical Female Connectors Type B

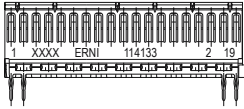
### Ordering Information

Configuration	Used For	No. of Pins	Part Number
Type B With Shield, Without Peg Version 6 *			
 		110	<b>114114</b>
Type B With F-row Shield, Without Peg Version 6 *	<b>CompactPCI™</b>		
 	P2 / P4	110	<b>114134</b>
Type B Without Shield, Without Peg Version 1 *			
 		95	<b>114111</b>
Type B With Shield, Without Peg Version 6 *			
 		95	<b>114112</b>
Type B With F-row Shield, Without Peg Version 6 *	<b>CompactPCI™</b>		
 	P2 / P4	95	<b>114133</b>

## Right Angle Female Connectors Type AB For Daughter Cards

125 signal contacts  
50 mm without multifunction block

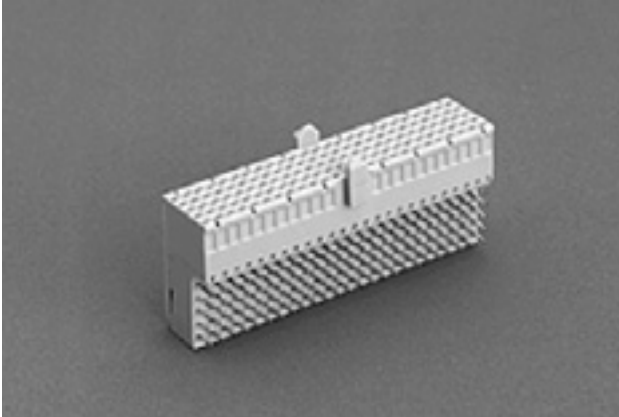

The ERmet type AB female connector provides 125 contacts in a 5 row x 25 fully loaded configuration, 110 contacts in a 5 row x 22 position fully loaded configuration or 95 pins in a 5 row x 19 position configuration. The 19 position connector is used in the rJ3 location and the 22 position connector is used in the rJ2 and rJ5 locations of the CompactPCI® rear transition card. The connector is designed for gas tight, pressfit installation and is provided in two different configurations: with integrated ground return shields and without integrated upper ground return shields. Lower ground return shields are available separately.

The ERmet type AB female connector has an uninterrupted pin field with no multifunction cavity but does have integral pre-alignment guides. This connector can be used alone or in conjunction with either a type A, B or C ERmet connector. This connector will provide the necessary alignment for rear transition applications.

### Dimensional drawings and board hole pattern

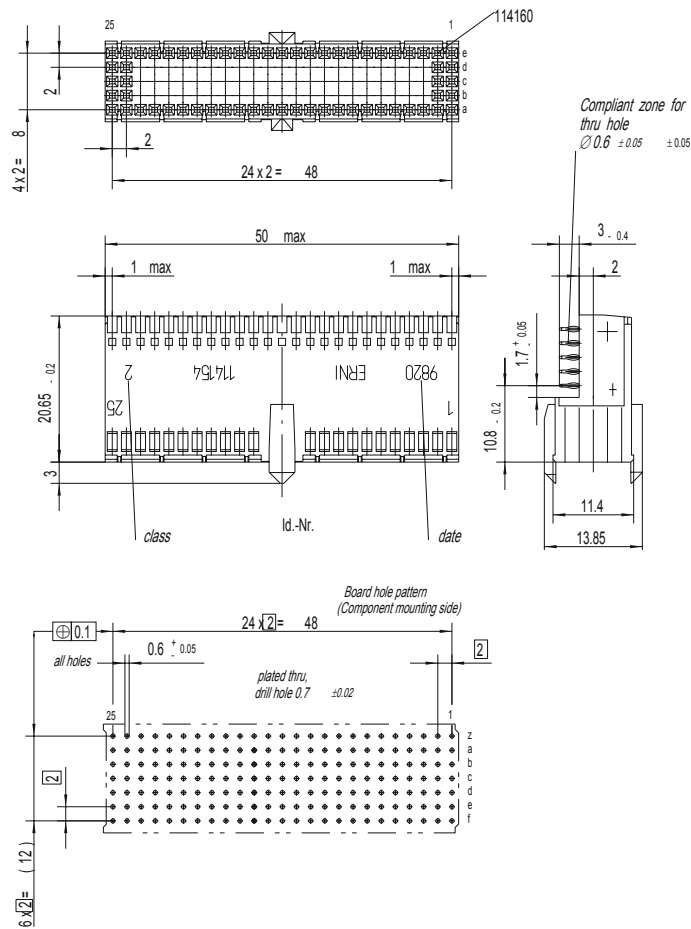

Note: The numbering on the connectors themselves is in accordance with the IEC 61076-4-101 standard. All dimensions in mm.

# Right Angle Female Connectors Type AB For Daughter Cards

## Ordering Information

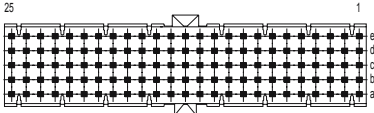
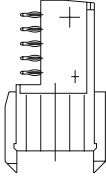
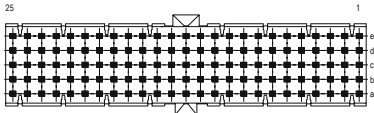
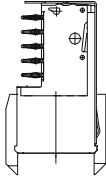
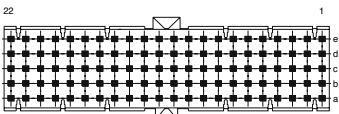
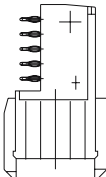
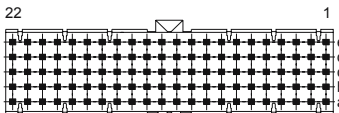
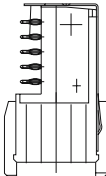
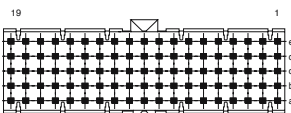
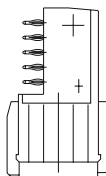
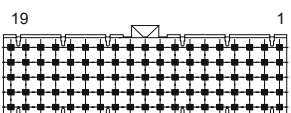
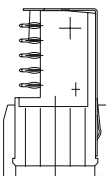
Configuration	Used For	No. of Pins	Part Number	
Type AB Without Shield, Without Peg  		125	<b>114154</b>	
Type AB With Shield, Without Peg  		125	<b>114538</b>	
Type AB Without Shield, Without Peg  	<b>CompactPCI™</b>	rJ2, rJ5	110	<b>104933</b>
Type AB With Shield, Without Peg  	<b>CompactPCI™</b>	rJ2, rJ5	110	<b>114809</b>
Type AB Without Shield, Without Peg  	<b>CompactPCI™</b>	rJ3	95	<b>114529</b>
Type AB With Shield, Without Peg  	<b>CompactPCI™</b>	rJ3	95	<b>114810</b>

## Right Angle Female Connectors Type AB For Daughter Cards

### Ordering Information

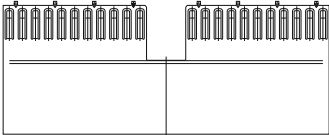
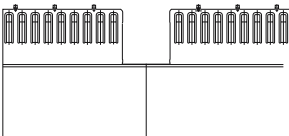
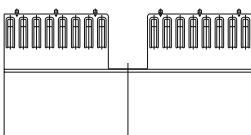
Configuration	Used For	No. of Pins	Part Number
Lower Shield For Type A And AB 			<b>044446</b>
Lower Shield For Type A And Type AB 			<b>114231</b>
Lower Shield For Type A And Type AB 			<b>923110</b>



## Vertical Male Connectors Type AB For Backplanes

125 signal contacts  
50 mm without multifunction block

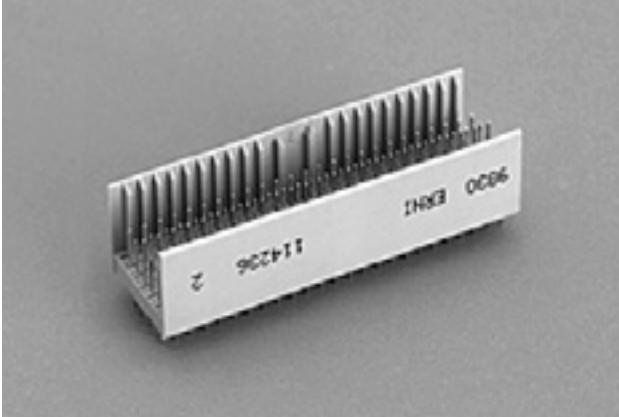

The ERmet type AB vertical male connector provides 125 signal contacts and 44 ground shield contacts in 5+2 row x 25 position, fully loaded configuration. This connector is used in the P1 and P4 positions of a CompactPCI® backplane. With 15 different standard pin lengths to choose from, this is one of the most versatile connectors available. The connector is designed for gas tight pressfit installation. The ERmet type AB male connector has an uninterrupted pin field with pre-alignment guides, but does not accept coding keys. This connector can be used alone, or it can be used with either type A, C, L, M or N ERmet connectors.

### Dimensional drawings and board hole pattern

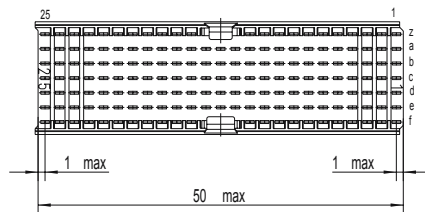
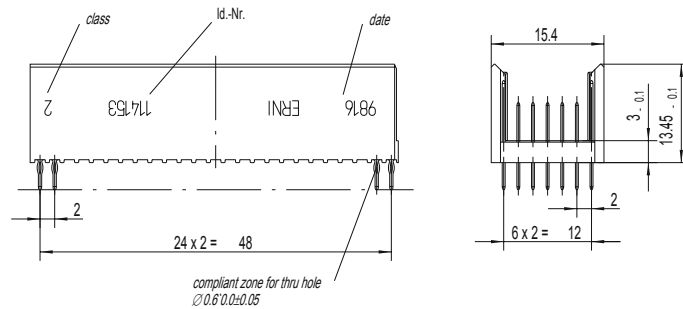

Lochbild fuer Leiterplatte  
(Bestueckungsseite)

Board hole pattern  
(Component mounting side)

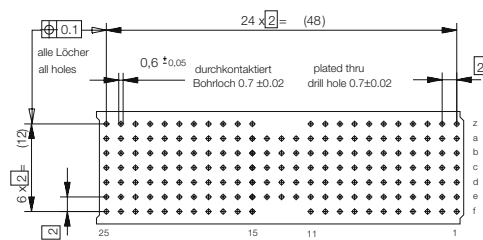

Note: The numbering on the connectors themselves is in accordance with the IEC 61076-4-101 standard. All dimensions in mm.

# Vertical Male Connectors Type AB For Backplanes

## Ordering Information

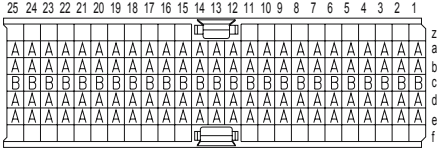
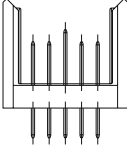
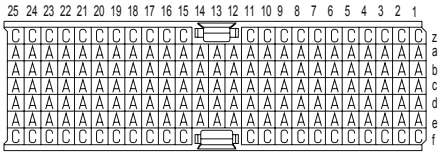
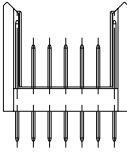
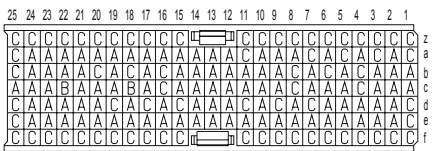
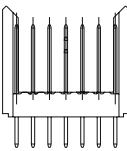
Configuration	Used For	No. of Pins	Part Number
Type AB Without Shield, Without Peg  		125	114236
Type AB With Shield, Without Peg  		169	114153
Type AB With Shield, Without Peg  		169	114539

### Contact versions

ERNI can accommodate any pattern of male connector contact loading. For shield rows z and f (7 row connectors) or z and y (10 row connectors), level 3 contacts should be specified. For rear I/O and shrouds, choose contacts with the R1, R2 or R3 terminal length. Each contact has a unique letter designation. Use this letter designation when filling in the contact loading requirements on the ERNI Customer Request Form.

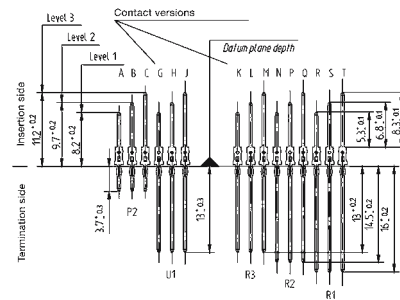

## Right Angle Female Connectors Type C For Daughter Cards

55 signal contacts  
25 mm extension module



The ERmet type C female connector provides 55 contacts in a 5 row x 11 position fully loaded configuration.

The connector is designed for gas tight, pressfit installation and is provided in two different configurations: with integrated upper ground return shields and without integrated upper ground return shields. Lower ground return shields are available separately.

The ERmet type C female connector has pre-alignment guides. This connector can be used alone or in conjunction with either a type A, B, L, M or N ERmet connector, however, it can only be installed at the lower end of a connector row.

The type C female is also available with a locating and strain relief peg that helps secure the connector to the printed circuit board (PCB).

### Dimensional drawings and board hole pattern

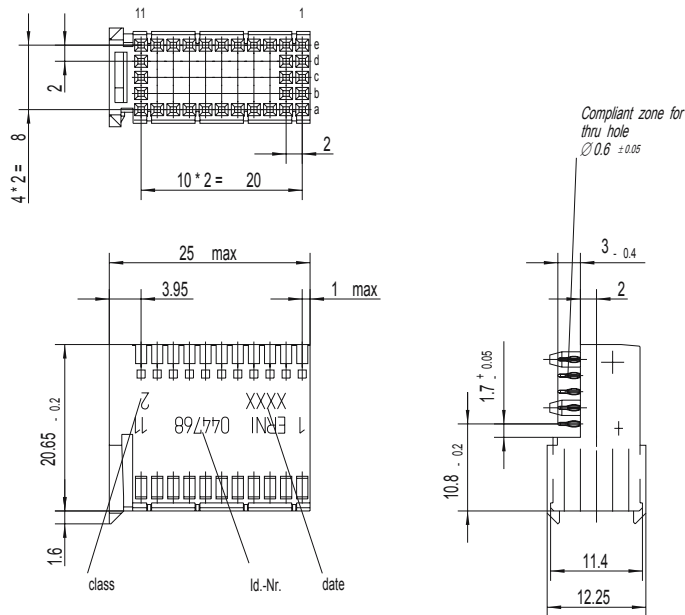

Board hole pattern  
(Component mounting side)

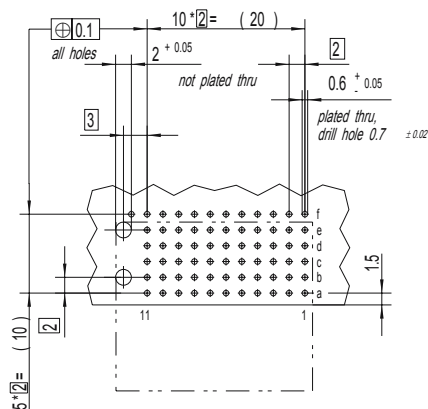

Note: The numbering on the connectors themselves is in accordance with the IEC 61076-4-101 standard. All dimensions in mm.

## Right Angle Female Connectors Type C For Daughter Cards

### Ordering Information

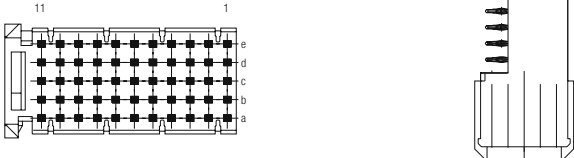
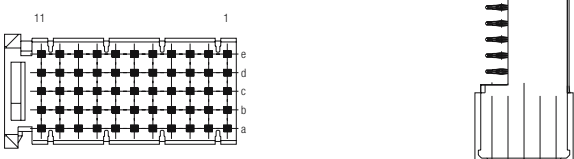
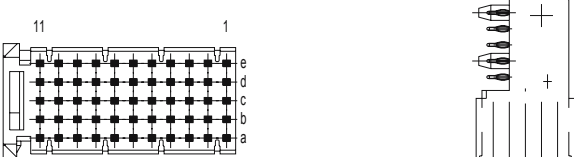
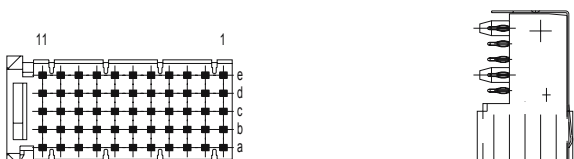
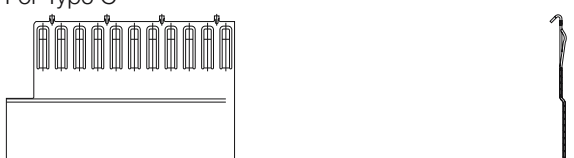
Configuration	Used For	No. of Pins	Part Number
Type C Without Shield, Without Peg 		55	<b>044145</b>
Type C With Shield, Without Peg 		55	<b>064198</b>
Type C Without Shield, With Peg 		55	<b>044768</b>
Type C With Shield, With Peg 		55	<b>064556</b>
Lower Shield For Type C 			<b>044458</b>

ERmet 2.0mm

## Vertical Male Connectors Type C For Backplanes

55 signal contacts  
25 mm extension module



The ERmet type C vertical male connector provides 55 signal contacts and 22 ground shield contacts in 5+2 row x 11 position, fully loaded configuration. With 15 different standard pin lengths to choose from, this is one of the most versatile connectors available. The connector is designed for gas tight pressfit installation.

The ERmet type C vertical male connector incorporates pre-alignment guides but has no multi function cavity. This connector is designed to be used alone or in conjunction with either type B, L, M or N ERmet connectors, however it can only be installed at the lower end of a connector row.

### Dimensional drawings and board hole pattern

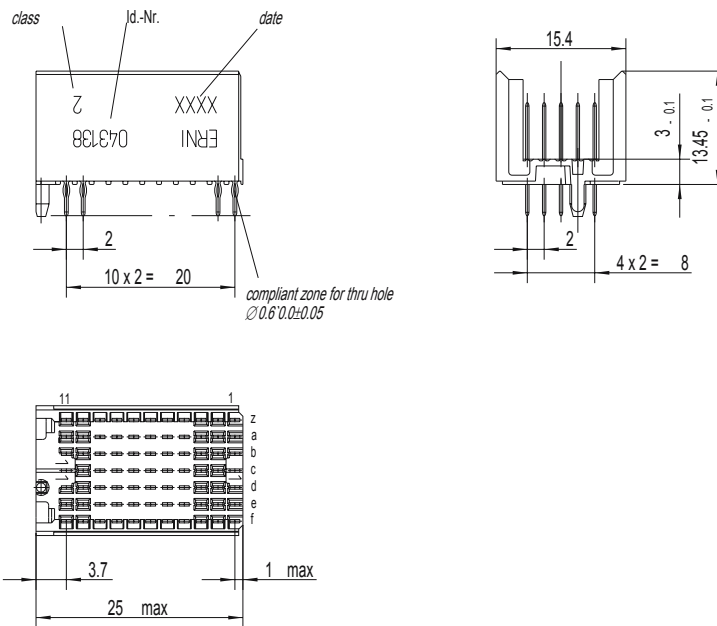

Board hole pattern  
(Component mounting side)

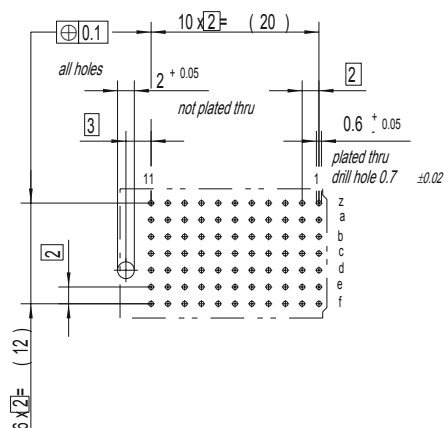

Note: The numbering on the connectors themselves is in accordance with the IEC 61076-4-101 standard. All dimensions in mm.

# Vertical Male Connectors Type C For Backplanes

## Ordering Information

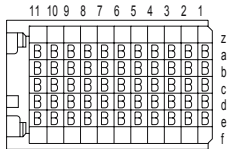
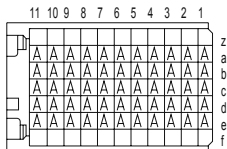
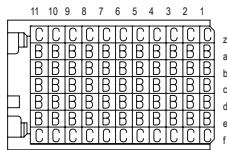
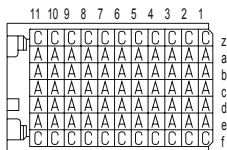
Configuration	Used For	No. of Pins	Part Number
Type C Without Shield, With Peg 		55	<b>043138</b>
Type C Without Shield, With Peg 		55	<b>044147</b>
Type C With Shield, Without Peg 		77	<b>054546</b>
Type C With Shield, With Peg 		77	<b>053009</b>

### Contact versions

ERNI can accommodate any pattern of male connector contact loading. For shield rows z and f (7 row connectors) or z and y (10 row connectors), level 3 contacts should be specified. For rear I/O and shrouds, choose contacts with the R1, R2 or R3 terminal length. Each contact has a unique letter designation. Use this letter designation when filling in the contact loading requirements on the ERNI Customer Request Form.

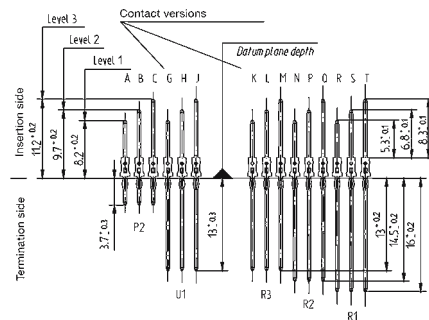

# Vertical Male Connectors Type C For Backplanes

## Ordering Information

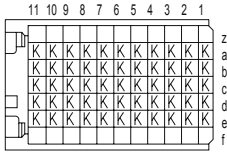
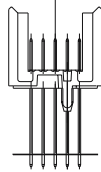
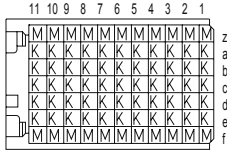
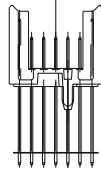
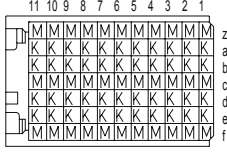
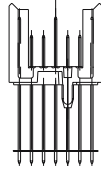
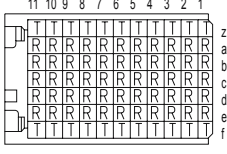
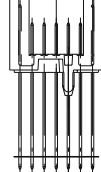
Configuration	Used For	No. of Pins	Part Number
Type C Without Shield, With Peg And With Extended Terminals  		55	<b>054129</b>
Type C With Shield, With Peg And With Extended Terminals  		77	<b>064550</b>
Type C With Shield, With Peg And With Extended Terminals  		77	<b>064572</b>
Type C With Shield, With Peg And With Extended Terminals  		77	<b>103926</b>

### Contact versions

ERNI can accommodate any pattern of male connector contact loading. For shield rows z and f (7 row connectors) or z and y (10 row connectors), level 3 contacts should be specified. For rear I/O and shrouds, choose contacts with the R1, R2 or R3 terminal length. Each contact has a unique letter designation. Use this letter designation when filling in the contact loading requirements on the ERNI Customer Request Form.

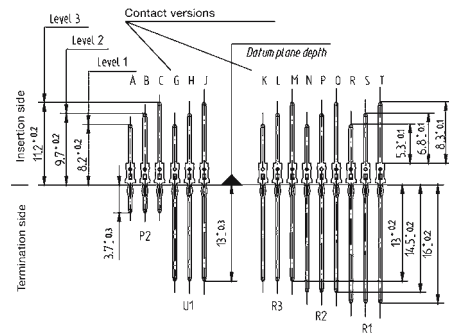

# Vertical Female Connectors Type C

55 signal contacts  
25 mm extension module

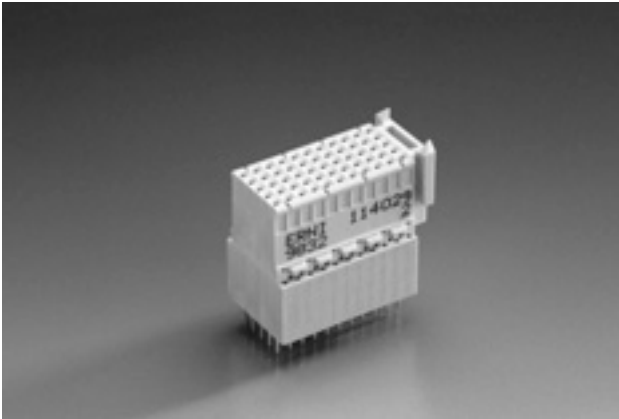

The ERmet type C vertical female connector provides 55 contacts in a 5 row x 11 position fully loaded configuration. Versions with optional “z” and “f” row shields are available as well as extended terminals for use in stacking applications with rear shrouds.

Two spacer heights are also available: 3.1 mm and 9.6 mm to provide necessary component clearance.

The ERmet type C vertical female has no multifunctional cavity but is equipped with pre-alignment guides. The pressfit terminals provide a convenient and reliable gas tight connection.

This connector may be used alone or in conjunction with either a type A or B vertical female connector, however it can only be installed at the lower end of a connector row.

## Dimensional drawings and board hole pattern

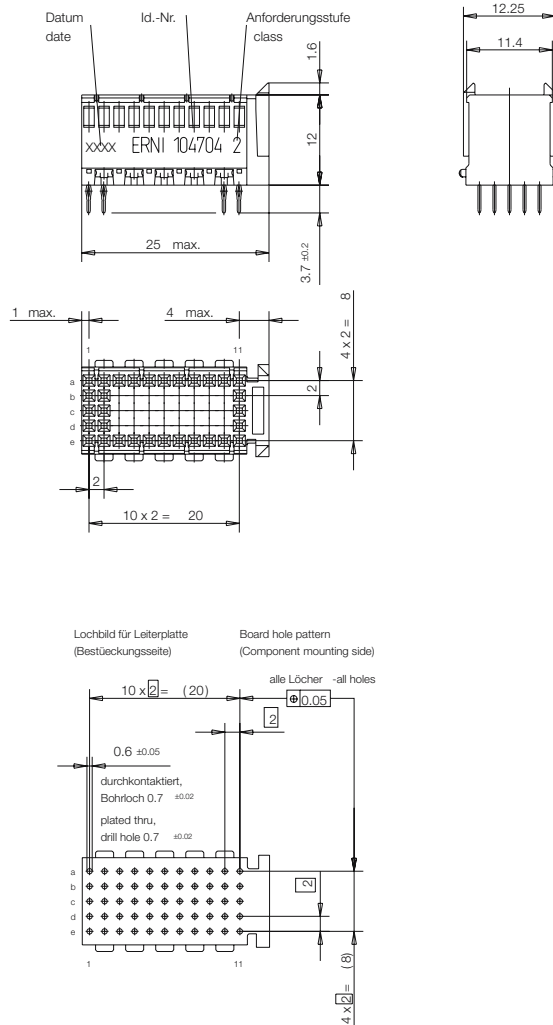

Note: The numbering on the connectors themselves is in accordance with the IEC 61076-4-101 standard. All dimensions in mm.



# Vertical Female Connectors Type C

## \* Termination + Board To Board Distance

### Version Without Shield

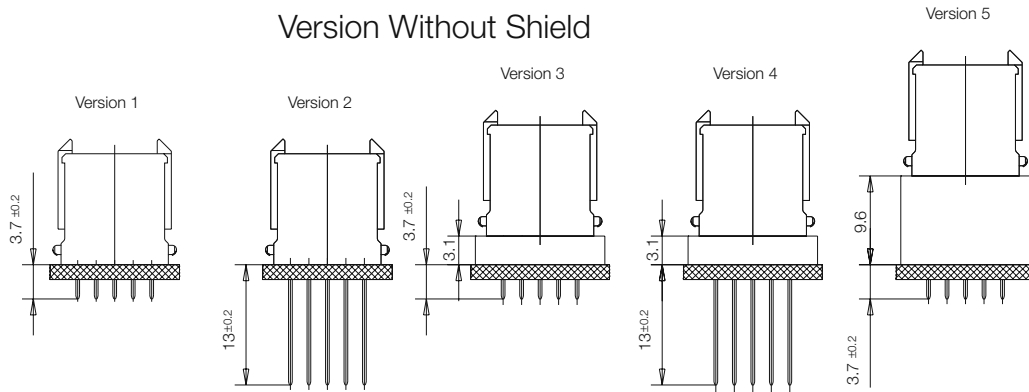

Version	Board To Board Distance *
1	15-16.5
2	15-16.5
3	18.4-20
4	18.4-20
5	25-26.5

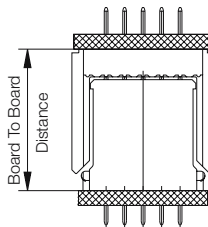

\* based on contact level 1  
 other board to board distances for  
 remaining levels on request  
 (Please contact our Customer Service)

### Version With Shield

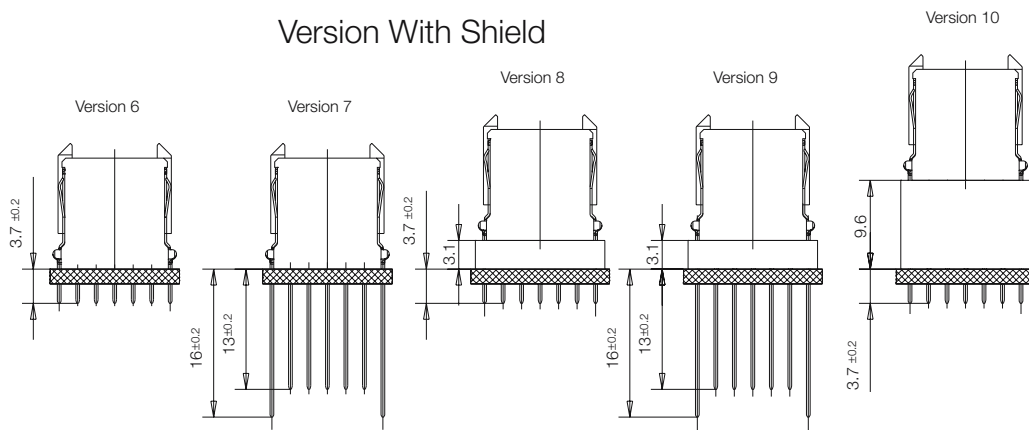

Version	Board To Board Distance *
6	15-16.5
7	15-16.5
8	18.4-20
9	18.4-20
10	25-26.5

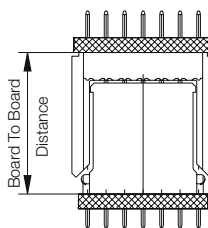

\* based on contact level 1  
 other board to board distances for  
 remaining levels on request  
 (Please contact our Customer Service)

Note: All dimensions in mm.



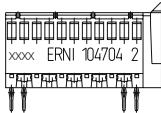
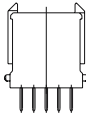
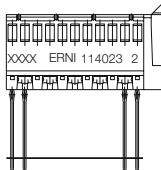
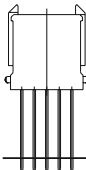
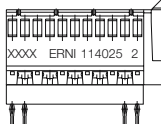
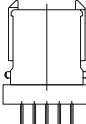
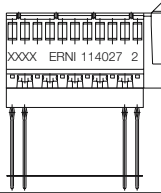
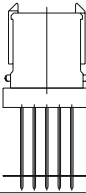
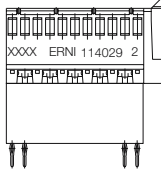
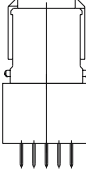

## Vertical Female Connectors Type C

### Ordering Information

Configuration	Used For	No. of Pins	Part Number	
Type C Without Shield, Without Peg Version 1 *			55	<b>104704</b>
Type C Without Shield, Without Peg Version 2 *			55	<b>114023</b>
Type C Without Shield, Without Peg Version 3 *			55	<b>114025</b>
Type C Without Shield, Without Peg Version 4 *			55	<b>114027</b>
Type C Without Shield, Without Peg Version 5 *			55	<b>114029</b>

## Vertical Female Connectors Type C

### Ordering Information

Configuration	Used For	No. of Pins	Part Number
Type C With Shield, Without Peg Version 6 * 		55	<b>104114</b>
Type C With Shield, Without Peg Version 7 * 		55	<b>114024</b>
Type C With Shield, Without Peg Version 8 * 		55	<b>114026</b>
Type C With Shield, Without Peg Version 9 * 		55	<b>114028</b>
Type C With Shield, Without Peg Version 10 * 		55	<b>114030</b>

## Right Angle Female Connectors Type D For Daughter Cards

176 signal contacts  
50 mm with multifunction block (for positioning and coding)

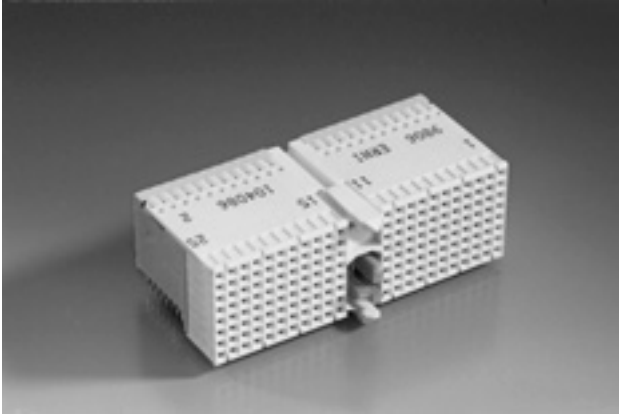

The ERmet type D female connector provides 176 signal contacts and 44 ground shield contacts in a 8 row x 25 position (3 positions used by multifunction cavity), fully loaded configuration.

The connector provides for a gas tight, pressfit installation and is designed for two different configurations: with integrated upper ground return shields and without integrated upper ground return shields.

The ERmet type D female connector has a multifunction cavity that incorporates pre-alignment guides and accepts optional coding keys. This connector is designed to be used by itself or in conjunction with either a type E or F ERmet 2mm H.M. connector.

The type D female is also available with locating and strain relief peg that helps secure the connector to the printed circuit board (PCB).

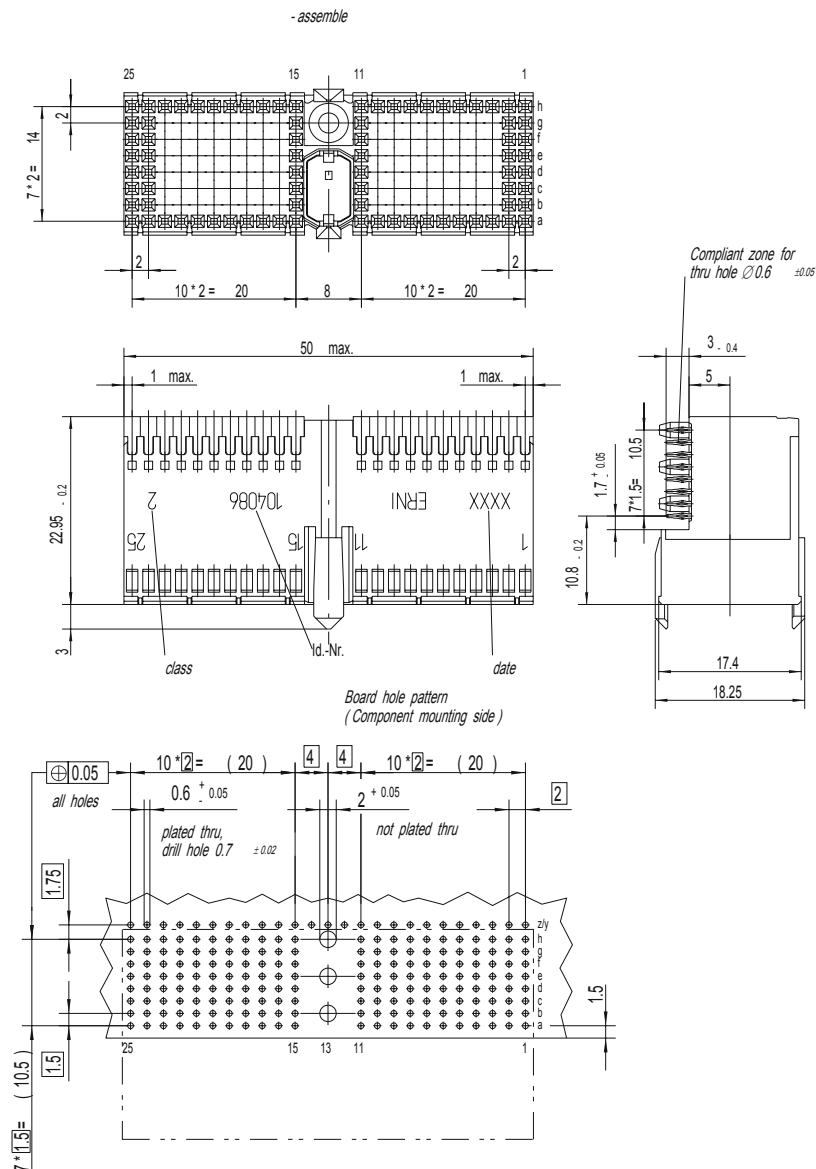

### Dimensional drawings and board hole pattern



Note: The numbering on the connectors themselves is in accordance with the IEC 61076-4-101 standard. All dimensions in mm.

# Right Angle Female Connectors Type D For Daughter Cards

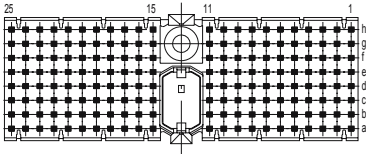
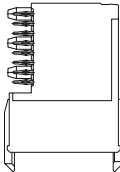
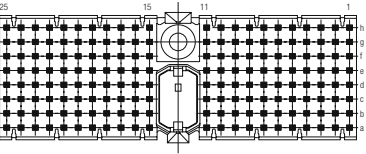
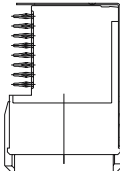
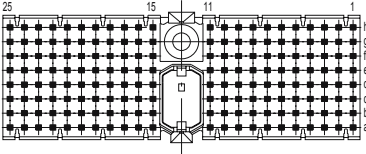
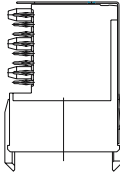
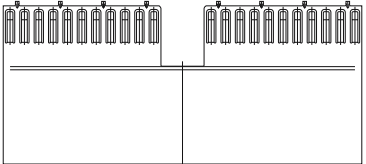
## Ordering Information

Configuration	Used For	No. of Pins	Part Number
<p>Type D Without Shield, With Peg</p>  		176	<b>104086</b>
<p>Type D With Shield, Without Peg</p>  		176	<b>104935</b>
<p>Type D With Upper Shield, With Peg</p>  		176	<b>104415</b>
<p>Lower Shield For Type D And DE</p>  			<b>103847</b>

# Vertical Male Connectors Type D For Backplanes

176 signal contacts  
 50 mm with multifunction block (for positioning and coding)

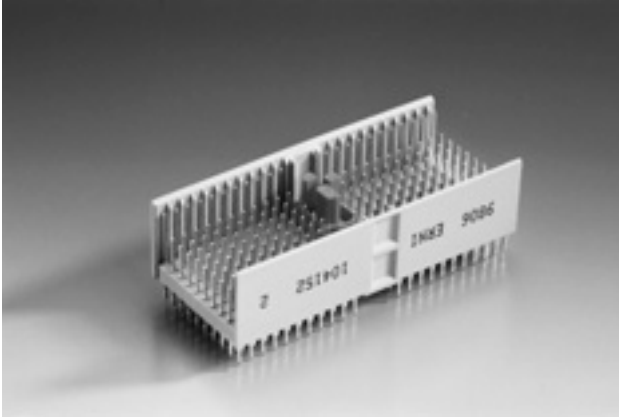

The ERmet type D vertical male connector provides up to 176 signal contacts and 44 ground shield contacts in 8+2 row x 25 position (3 positions used by multifunction cavity), fully loaded configuration. With 15 different standard pin lengths to choose from, this is one of the most versatile connectors available. The connector is designed for gas tight pressfit installation.

The ERmet type D male connector has a multifunction cavity that incorporates pre-alignment guides and accepts optional coding keys. This connector is designed to be used alone or in conjunction with either type E, DE or F ERmet 2mm H.M. connectors.

## Dimensional drawings and board hole pattern

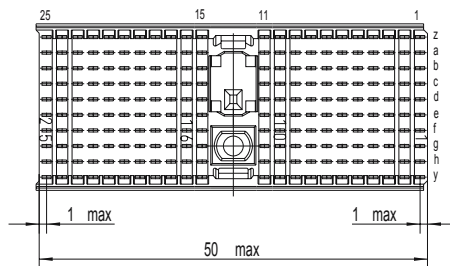
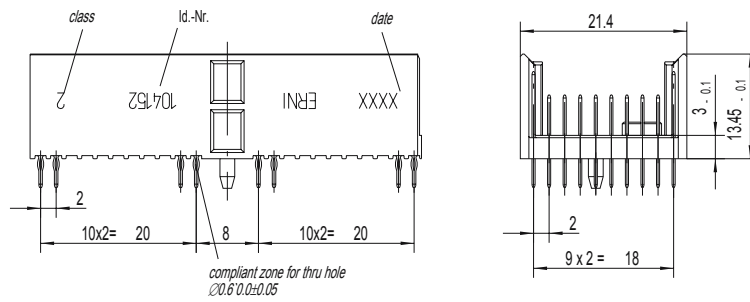

Lochbild fuer Leiterplatte (Bestueckungsseite)

Board hole pattern (Component mounting side)

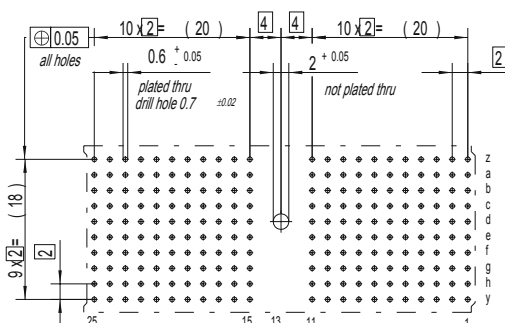

Note: The numbering on the connectors themselves is in accordance with the IEC 61076-4-101 standard. All dimensions in mm.

# Vertical Male Connectors Type D For Backplanes

## Ordering Information

Configuration	Used For	No. of Pins	Part Number
Type D With Peg 		220	<b>104152</b>
Type D With Peg 		220	<b>104517</b>
Type D With Peg and Extended Terminals 		220	<b>933008</b>

### Contact versions

ERNI can accommodate any pattern of male connector contact loading.

For shield rows z and f (7 row connectors) or z and y (10 row connectors), level 3 contacts should be specified. For rear I/O and shrouds, choose contacts with the R1, R2 or R3 terminal length. Each contact has a unique letter designation. Use this letter designation when filling in the contact loading requirements on the ERNI Customer Request Form.

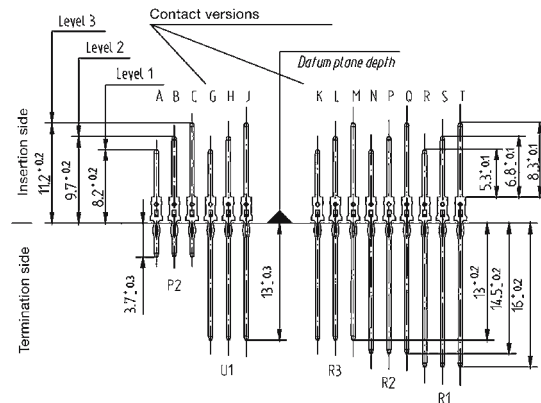

## Vertical Female Connectors Type D

176 signal contacts  
50 mm with multifunction block (for positioning and coding)

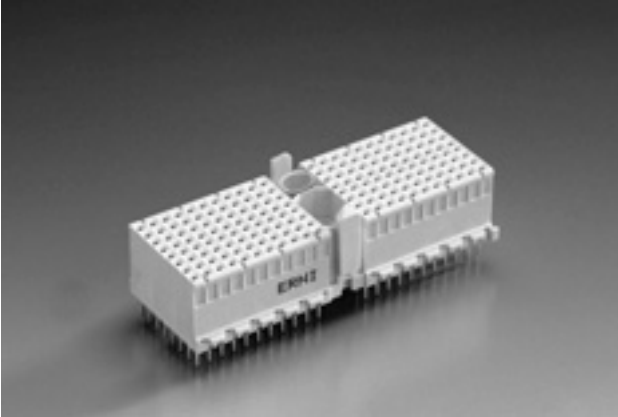

The ERmet type D vertical female connector provides 176 signal contacts in a 8 row x 25 position (3 positions used by multifunction cavity), fully loaded configuration.

The connector provides for a gas tight, pressfit installation and is designed for two different configurations: with and without integrated ground return shields.

The ERmet type D vertical female connector has a multifunction cavity that incorporates pre-alignment guides and accepts optional coding keys. This connector is designed to be used by itself or in conjunction with either a type E or F ERmet 2mm H.M. connector.

### Dimensional drawings and board hole pattern

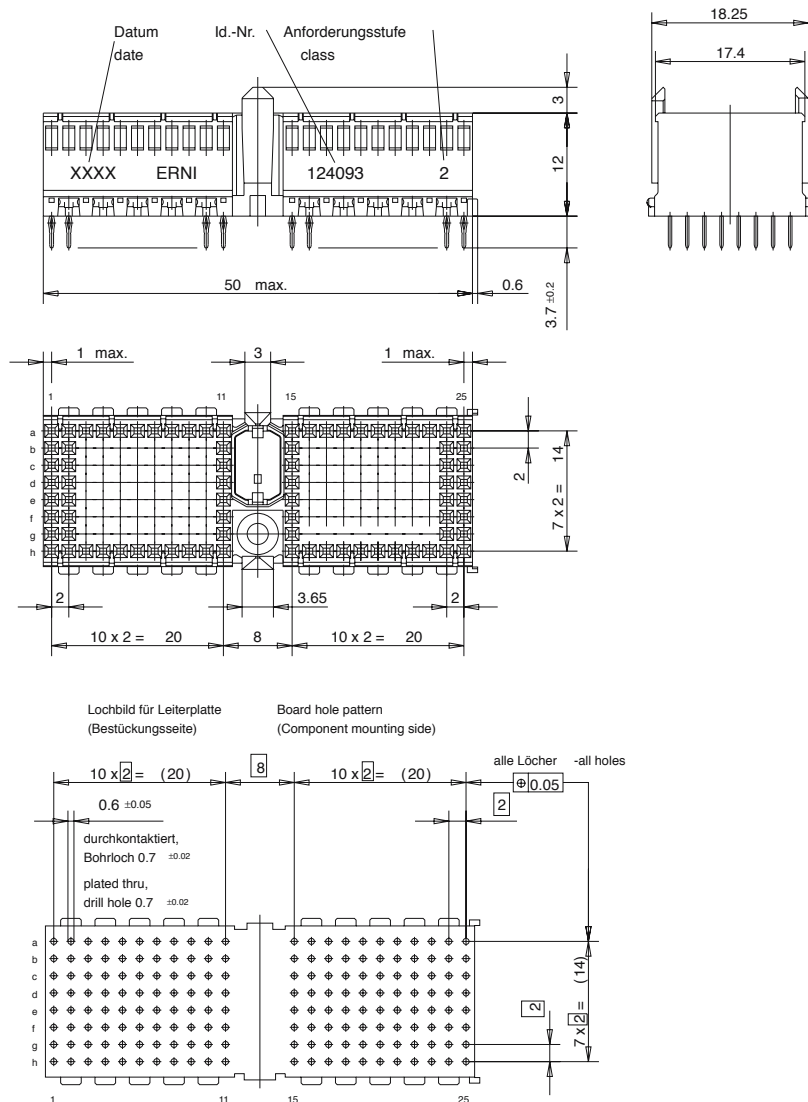

Note: The numbering on the connectors themselves is in accordance with the IEC 61076-4-101 standard. All dimensions in mm.



## Vertical Female Connectors Type D

### Ordering Information

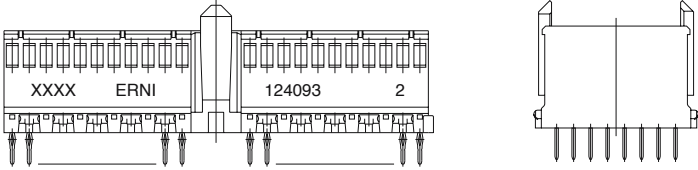
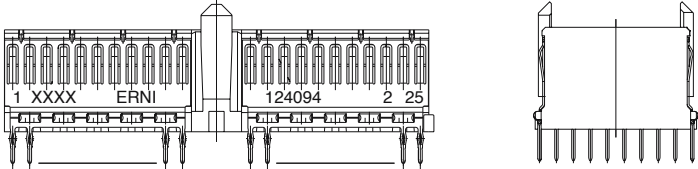
Configuration	Used For	No. of Pins	Part Number
Type D Without Shield, Without Peg		176	<b>124093</b>
Type D With Shield, Without Peg		176	<b>124094</b>

## Right Angle Female Connectors Type E For Daughter Cards

200 signal contacts  
50 mm without multifunction block



The ERmet type E female connector provides 200 signal contacts and 50 ground shield contacts in a 8 row x 25 position fully loaded configuration. These connectors are also available in an 8+2 row x 22 positions and 8+2 row x 19 positions.

The connector provides for a gas tight, pressfit installation and is designed for two different configurations: with integrated upper ground return shields and without integrated upper ground return shields.

The ERmet type E female connector has an uninterrupted pin field with no multifunction cavity. This connector is not designed to be used alone, but is intended to be used in conjunction with either a type D, DE or F ERmet 2mm H.M. connector.

### Dimensional drawings and board hole pattern

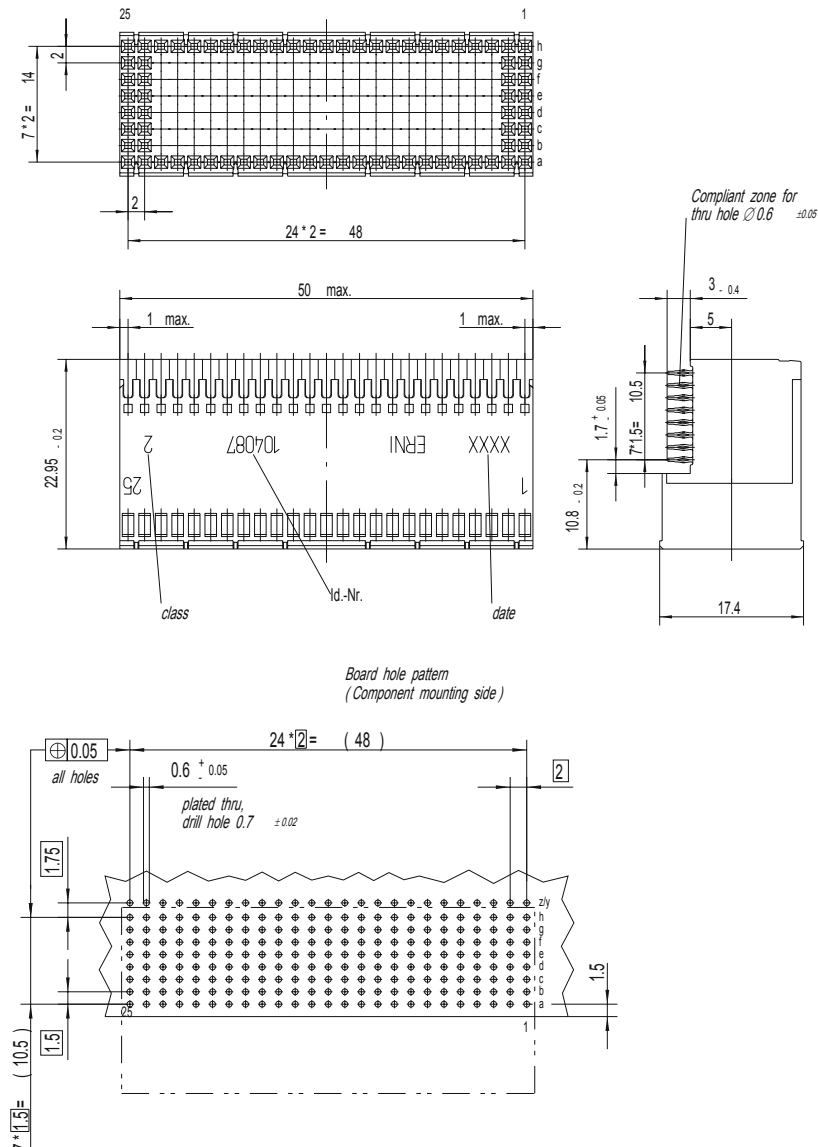

Note: The numbering on the connectors themselves is in accordance with the IEC 61076-4-101 standard. All dimensions in mm.

# Right Angle Female Connectors Type E For Daughter Cards

## Ordering Information

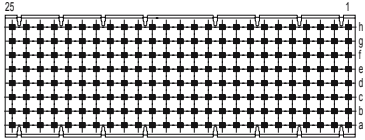
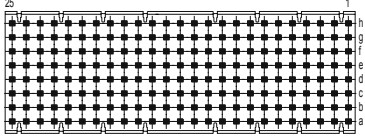
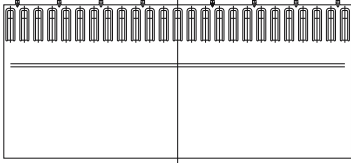
Configuration	Used For	No. of Pins	Part Number
Type E Without Shield, Without Peg		200	<b>104087</b>
Type E With Upper Shield, Without Peg		200	<b>104416</b>
Lower Shield For Type E			<b>103849</b>

## Vertical Male Connectors Type E For Backplanes

200 signal contacts  
50 mm without multifunction block

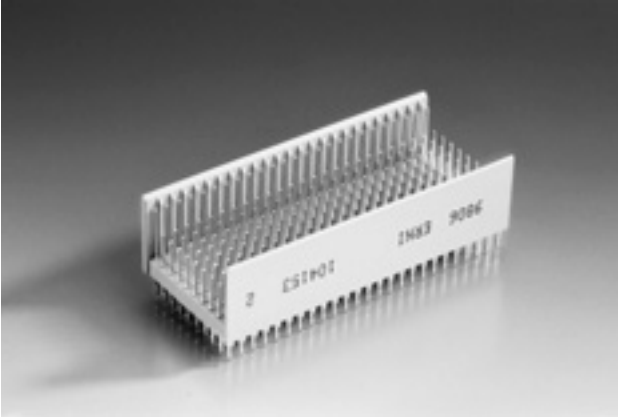

The ERmet type E vertical male connector provides 200 signal contacts and 50 ground shield contacts in an 8+2 row x 25 position fully loaded configuration. This connector is also available in an 8+2 row x 22 positions and 8+2 row x 19 positions. With 15 different standard pin lengths to choose from, this is one of the most versatile connectors available. The connector is designed for gas tight pressfit installation.

The ERmet type E vertical male connector has an uninterrupted pin field with no multifunction cavity. This connector is not designed to be used alone, but is intended to be used in conjunction with either type D, DE or F ERmet 2mm H.M. connectors.

### Dimensional drawings and board hole pattern

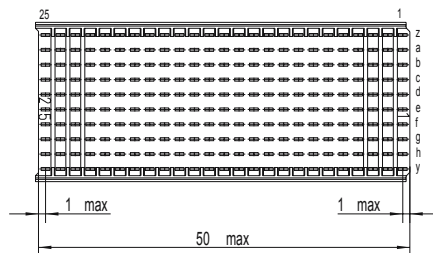
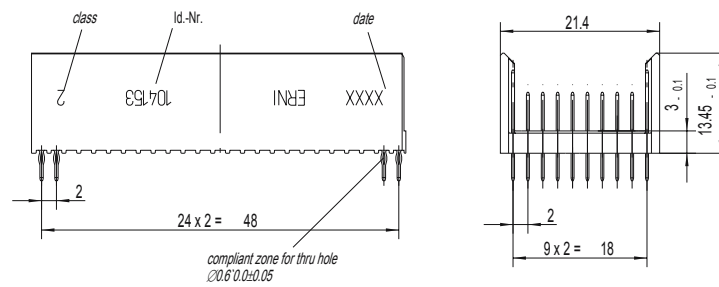

Board hole pattern  
(Component mounting side)

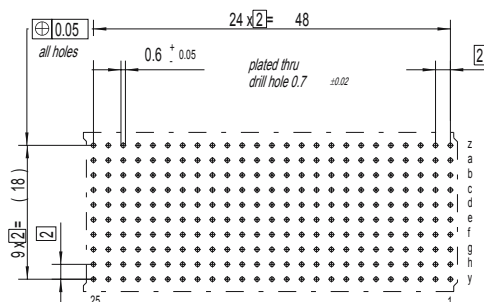

Note: The numbering on the connectors themselves is in accordance with the IEC 61076-4-101 standard. All dimensions in mm.

# Vertical Male Connectors Type E For Backplanes

## Ordering Information

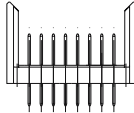
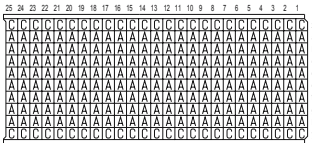
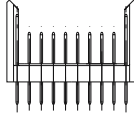
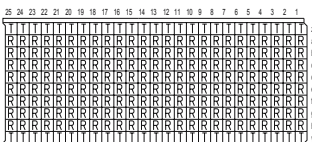
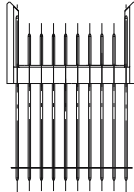
Configuration	Used For	No. of Pins	Part Number
Type E Without Peg  		200	<b>104518</b>
Type E Without Peg  		250	<b>104153</b>
Type E Without Peg, With Extended Terminals  		250	<b>933007</b>

### Contact versions

ERNI can accommodate any pattern of male connector contact loading. For shield rows z and f (7 row connectors) or z and y (10 row connectors), level 3 contacts should be specified. For rear I/O and shrouds, choose contacts with the R1, R2 or R3 terminal length. Each contact has a unique letter designation. Use this letter designation when filling in the contact loading requirements on the ERNI Customer Request Form.

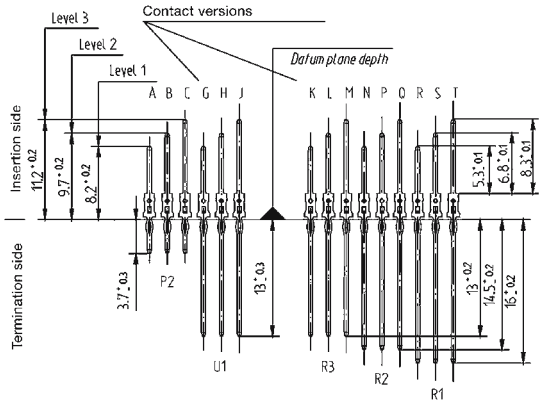

# Vertical Female Connectors Type E

200 signal contacts  
50 mm without multifunction block



The ERmet type E vertical female connector provides 200 signal contacts in a 8 row x 25 position fully loaded configuration.

The connector provides for a gas tight, pressfit installation and is designed for two different configurations: with and without integrated ground return shields.

The ERmet type E vertical female connector has an uninterrupted pin field with no multifunction cavity. This connector is not designed to be used alone, but is intended to be used in conjunction with either a type D or F ERmet 2mm H.M. connector.

## Dimensional drawings and board hole pattern

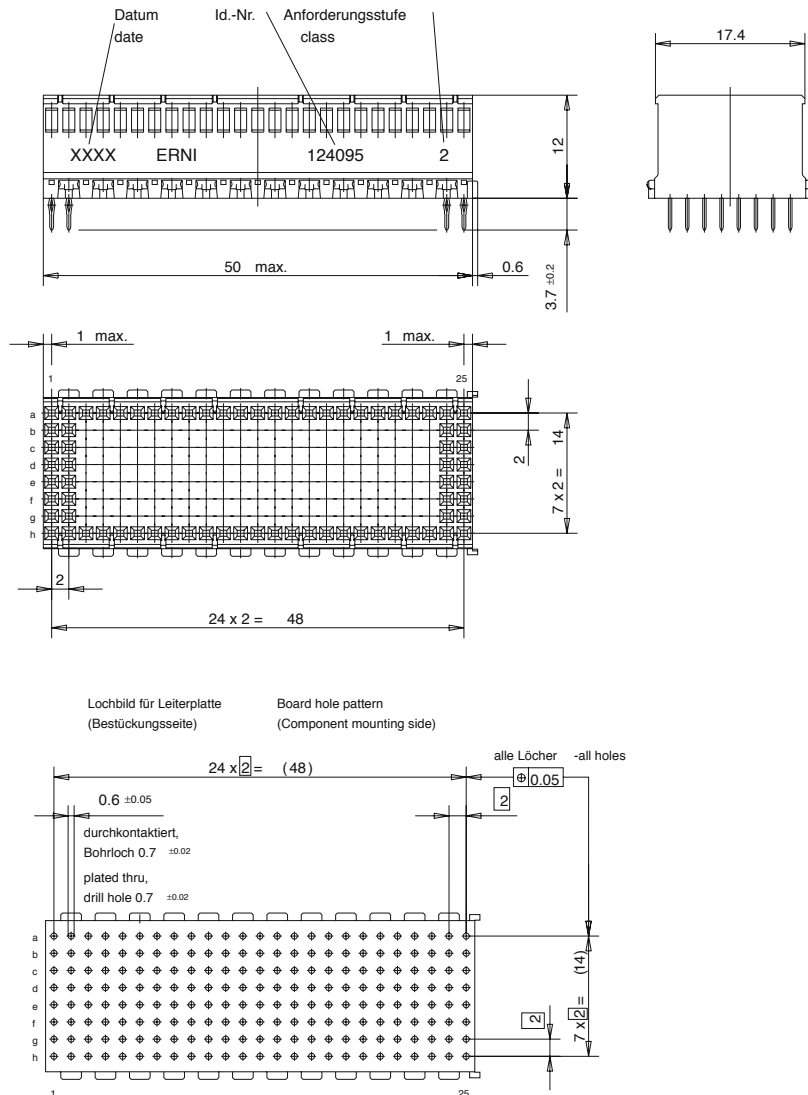

Note: The numbering on the connectors themselves is in accordance with the IEC 61076-4-101 standard. All dimensions in mm.

# Vertical Female Connectors Type E

## Ordering Information

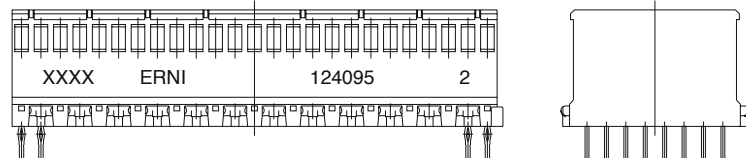
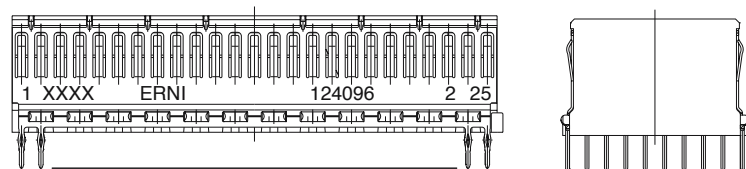
Configuration	Used For	No. of Pins	Part Number
<p>Type E Without Shield, Without Peg</p> 		200	<b>124095</b>
<p>Type E With Shield, Without Peg</p> 		200	<b>124096</b>

## Right Angle Female Connectors Type DE For Daughter Cards

200 signal contacts  
50 mm without multifunction block

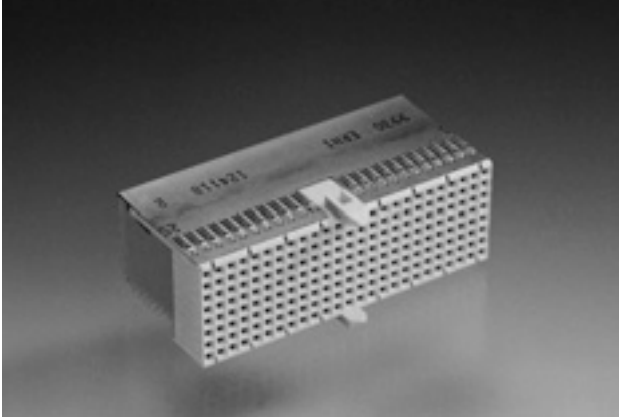

The ERmet type DE female connector provides 200 signal contacts and 25 ground shield contacts in an 8 row x 25 position fully loaded configuration.

The connector provides for a gas tight, pressfit installation and is designed for two different configurations: with integrated upper ground return shields and without integrated upper ground return shields.

The ERmet type DE female connector has an uninterrupted pin field and integral pre-alignment guide. This connector can be used alone or in conjunction with type D, E or F ERmet 2mm H.M. connector.

### Dimensional drawings and board hole pattern

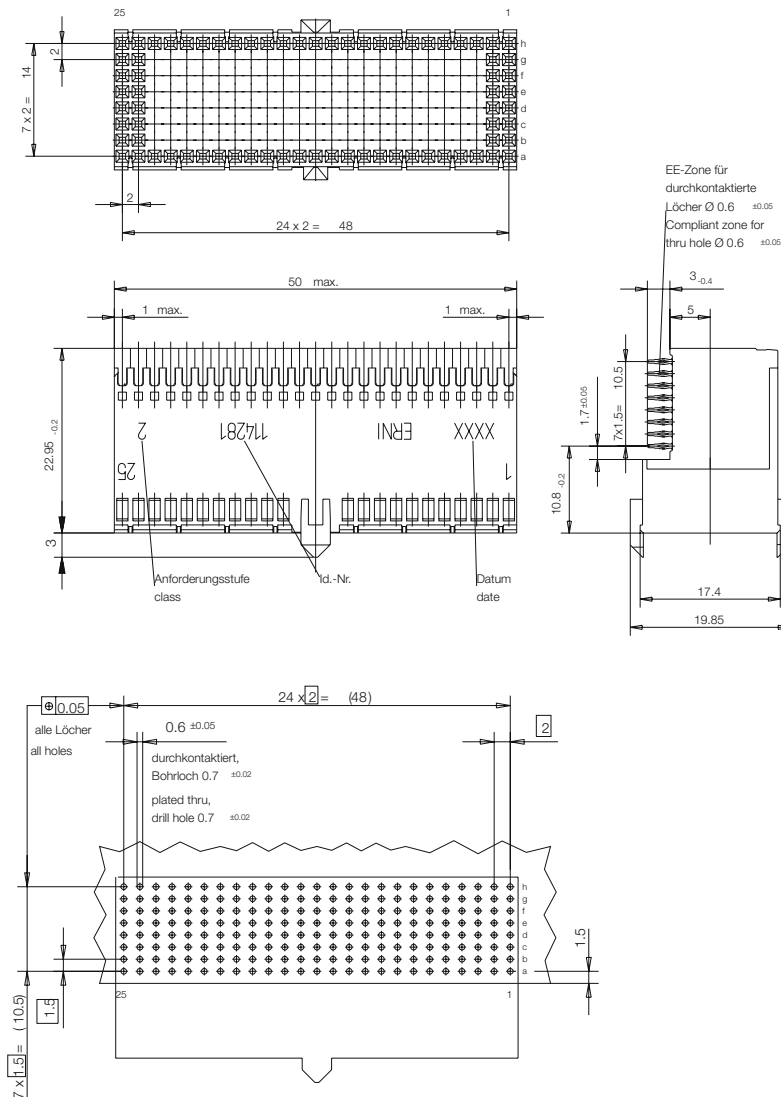

Note: The numbering on the connectors themselves is in accordance with the IEC 61076-4-101 standard. All dimensions in mm.



# Right Angle Female Connectors Type DE For Daughter Cards

## Ordering Information

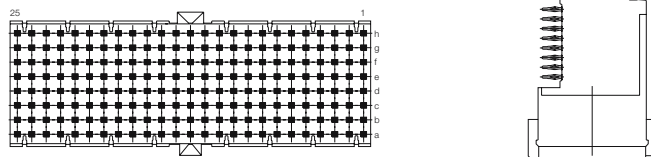
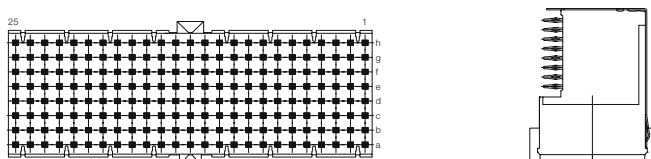
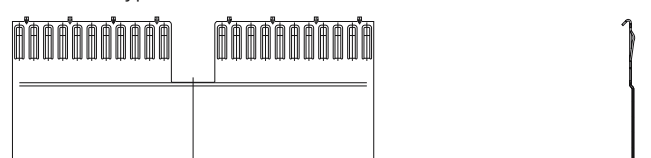
Configuration	Used For	No. of Pins	Part Number
<p>Type DE Without Shield, Without Peg</p> 		200	114281
<p>Type DE With Shield, Without Peg</p> 		200	124118
<p>Lower Shield For Type D And DE</p> 			103847

## Vertical Male Connectors Type DE For Backplanes

200 signal contacts  
50 mm without multifunction block

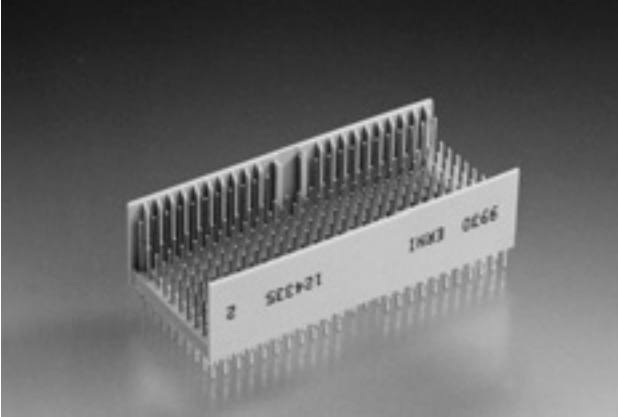

The ERmet type DE vertical male connector provides 200 signal contacts and 44 ground shield contacts in a 8+2 row x 25 position fully loaded configuration. With 15 different standard pin lengths to choose from, this is one of the most versatile connectors available. The connector is designed for gas tight pressfit installation.

The ERmet type DE vertical male connector has an uninterrupted pin field with pre-alignment guides but does not accept coding keys. This connector can be used alone, or it can be used with either type D or F ERmet connectors.

### Dimensional drawings and board hole pattern

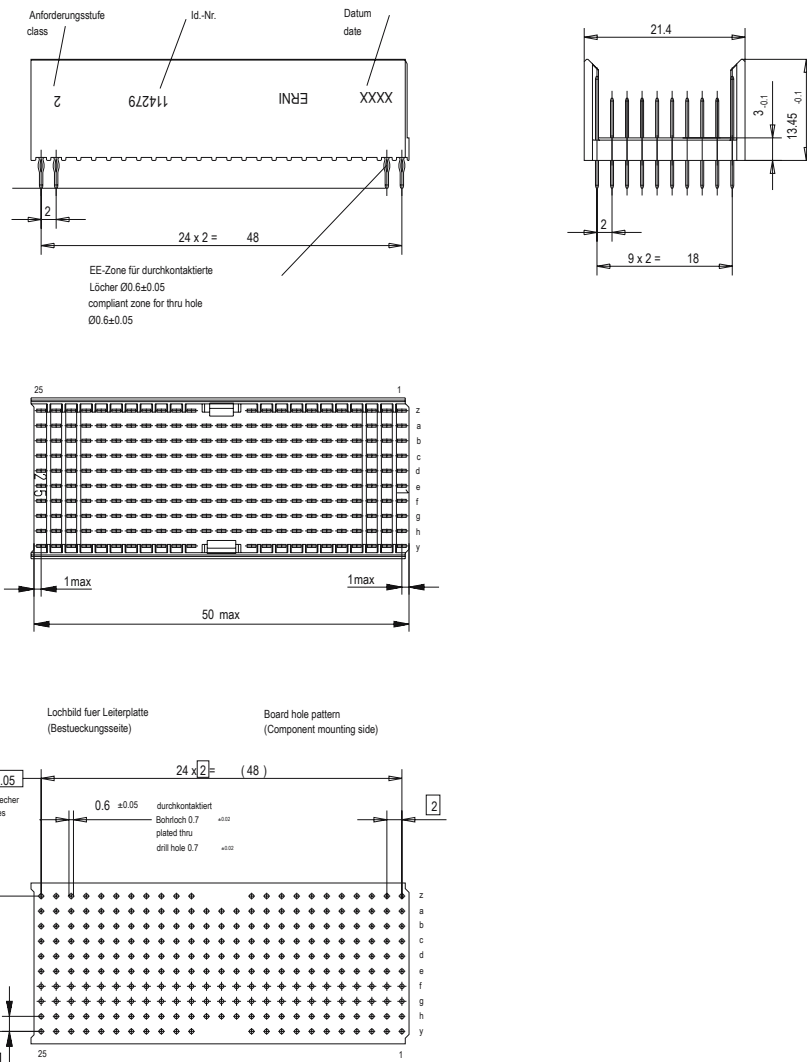

Note: The numbering on the connectors themselves is in accordance with the IEC 61076-4-101 standard. All dimensions in mm.

# Vertical Male Connectors Type DE For Backplanes

## Ordering Information

Configuration	Used For	No. of Pins	Part Number
Type DE Without Peg 		244	<b>114279</b>
Type DE Without Peg 		200	<b>124335</b>

### Contact versions

ERNI can accommodate any pattern of male connector contact loading.  
 For shield rows z and f (7 row connectors) or z and y (10 row connectors), level 3 contacts should be specified. For rear I/O and shrouds, choose contacts with the R1, R2 or R3 terminal length. Each contact has a unique letter designation. Use this letter designation when filling in the contact loading requirements on the ERNI Customer Request Form.

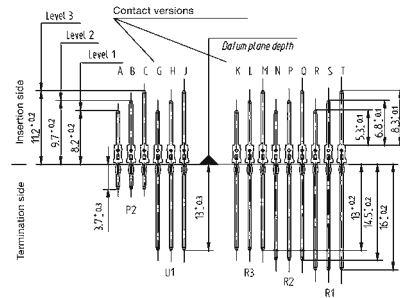

## Right Angle Female Connectors Type F For Daughter Cards

88 signal contacts  
25 mm extension module

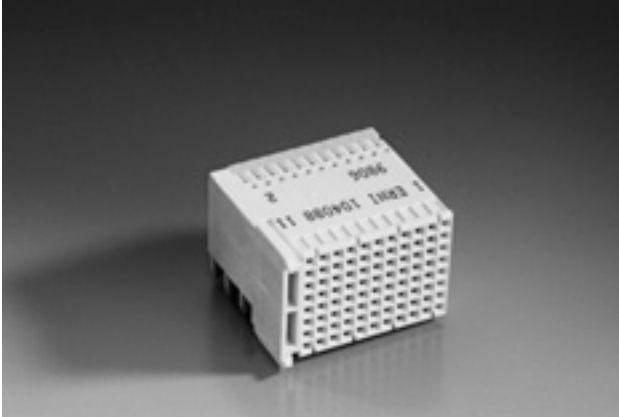

The ERmet type F female connector provides 88 signal contacts and 22 ground shield contacts in an 8 row x 11 position fully loaded configuration.

The connector provides for a gas tight, pressfit installation and is designed for two different configurations: with and without integrated ground return shields.

The ERmet type F female connector has integral pre-alignment guides but no multifunction cavity.

The type F female is also available with optional locating and strain relief pegs that help secure the connector to the printed circuit board (PCB). This connector is designed to be used alone or with either type D, DE or E ERmet connectors, however it can only be installed at the lower end of a connector field.

### Dimensional drawings and board hole pattern

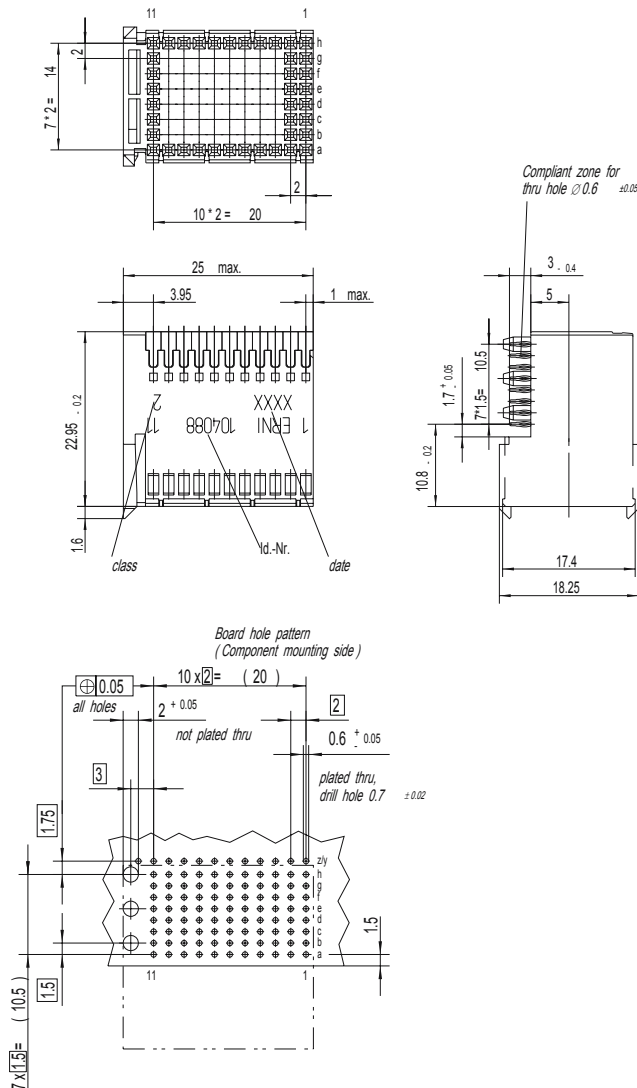

Note: The numbering on the connectors themselves is in accordance with the IEC 61076-4-101 standard. All dimensions in mm.

# Right Angle Female Connectors Type F For Daughter Cards

## Ordering Information

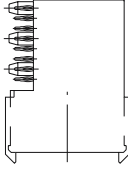
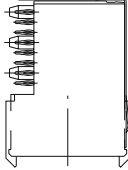
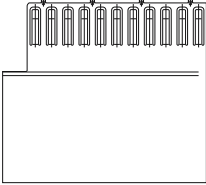
Configuration	Used For	No. of Pins	Part Number
Type F Without Shield, With Peg		88	<b>104088</b>
Type F With Shield, With Peg		88	<b>104417</b>
Lower Shield For Type F			<b>103851</b>

## Vertical Male Connectors Type F For Backplanes

88 signal contacts  
25 mm extension module

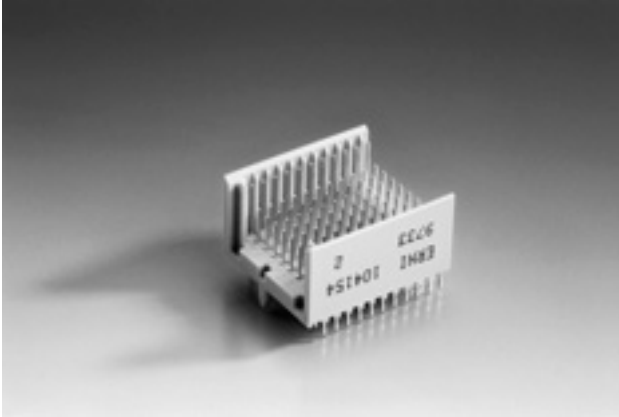

The ERmet type F vertical male connector provides 88 signal contacts and 22 ground shield contacts in a 8+2 row x 11, fully loaded configuration. With 15 different standard pin lengths to choose from, this is one of the most versatile connectors available. The connector is designed for gas tight pressfit installation.

The ERmet type F vertical male connector incorporates pre-alignment guides but has no multifunction cavity. This connector is designed to be used alone. The type F connector can also be used in conjunction with either a type D, E, or DE ERmet connector, however, it can only be installed at the lower end of a connector row.

### Dimensional drawings and board hole pattern

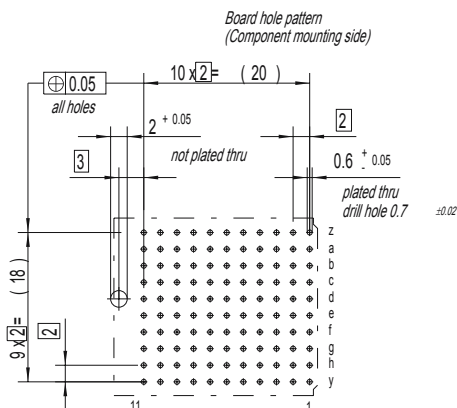
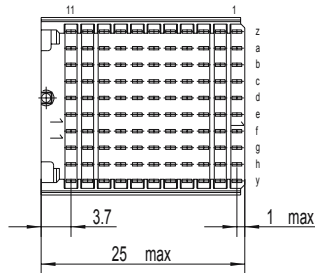
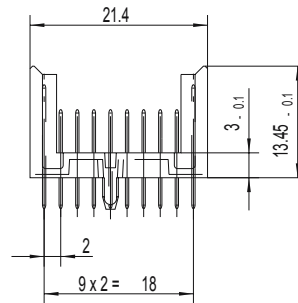
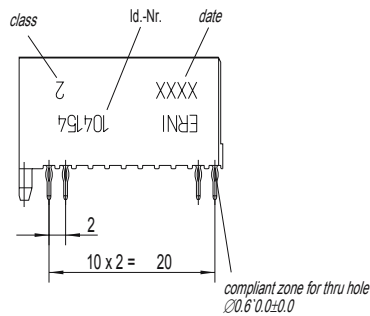

Note: The numbering on the connectors themselves is in accordance with the IEC 61076-4-101 standard. All dimensions in mm.

# Vertical Male Connectors Type F For Backplanes

## Ordering Information

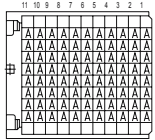
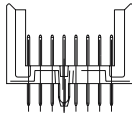
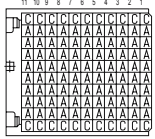
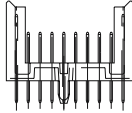
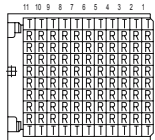
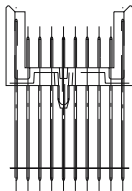
Configuration	Used For	No. of Pins	Part Number
Type F With Peg  		88	<b>104519</b>
Type F With Peg  		110	<b>104154</b>
Type F With Peg And Extended Terminals  		110	<b>933006</b>

### Contact versions

ERNI can accommodate any pattern of male connector contact loading. For shield rows z and f (7 row connectors) or z and y (10 row connectors), level 3 contacts should be specified. For rear I/O and shrouds, choose contacts with the R1, R2 or R3 terminal length. Each contact has a unique letter designation. Use this letter designation when filling in the contact loading requirements on the ERNI Customer Request Form.

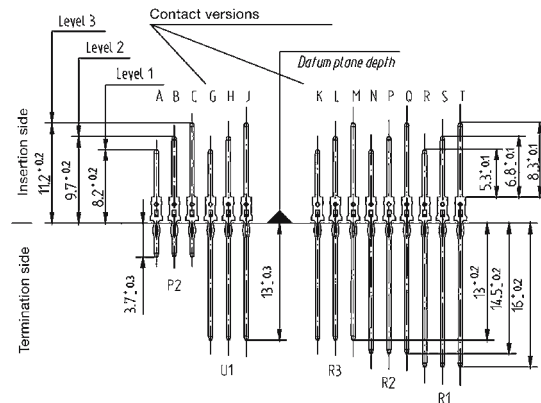

## Vertical Female Connectors Type F

88 signal contacts  
25 mm extension module

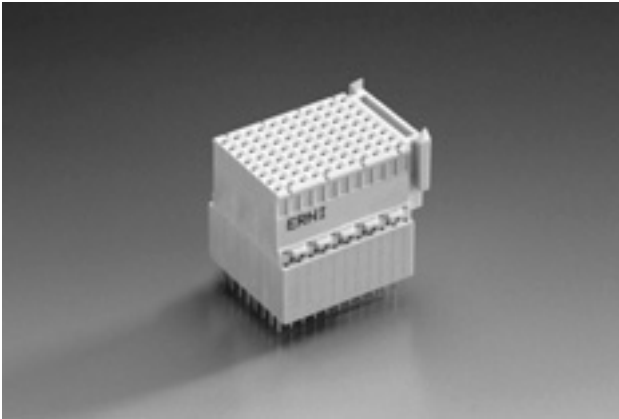

The ERmet type F vertical female connector provides 88 signal contacts and in an 8 row x 11 position fully loaded configuration.

The connector provides for a gas tight, pressfit installation and is designed for two different configurations: with and without integrated ground return shields.

The ERmet type F vertical female connector has integral pre-alignment guides but no multifunction cavity. This connector is designed to be used alone or with either type D or E ERmet connectors, however it can only be installed at the lower end of a connector field.

### Dimensional drawings and board hole pattern

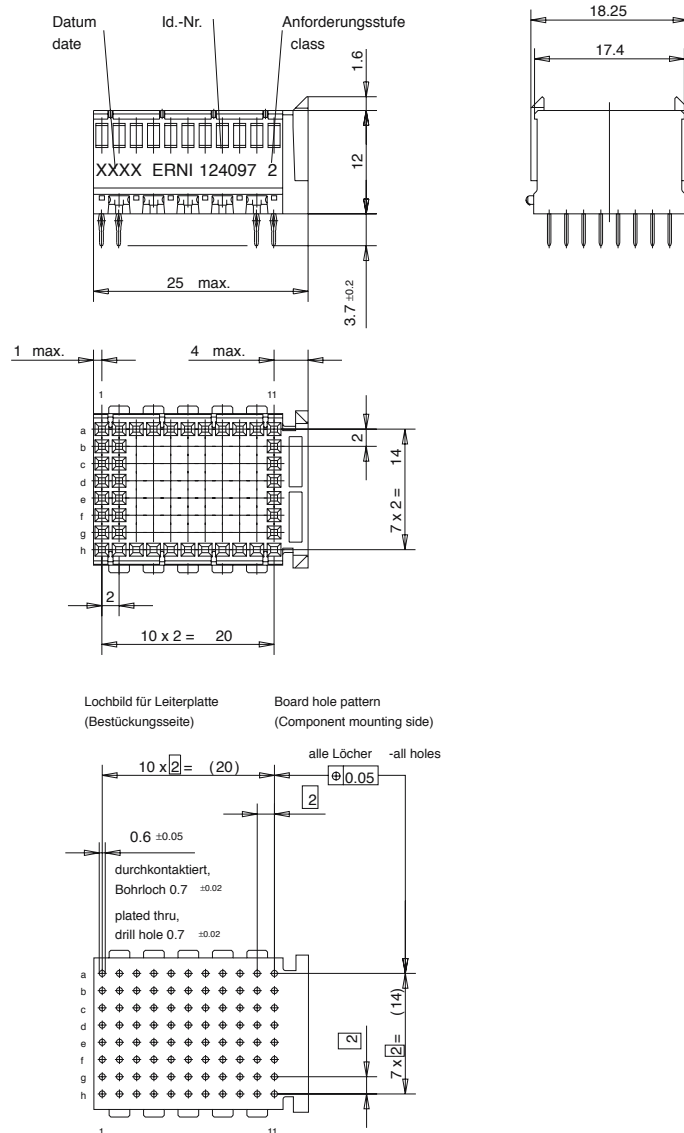

Note: The numbering on the connectors themselves is in accordance with the IEC 61076-4-101 standard. All dimensions in mm.



## Vertical Female Connectors Type F

### Ordering Information

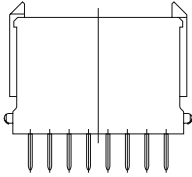
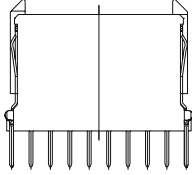
Configuration	Used For	No. of Pins	Part Number
Type F Without Shield, Without Peg		88	<b>124097</b>
Type F With Shield, Without Peg		88	<b>124098</b>



## Right Angle Female Connectors Type L For Daughter Cards

### Ordering Information

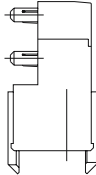
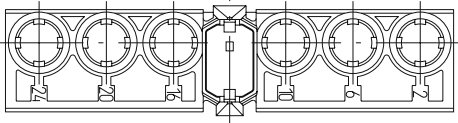
Configuration	Used For	No. of Pins	Part Number
Type L with 6 cavities for special contacts			<b>044579</b>
			

## Vertical Male Connectors Type L For Backplanes

6 special contacts  
50 mm with multifunction block

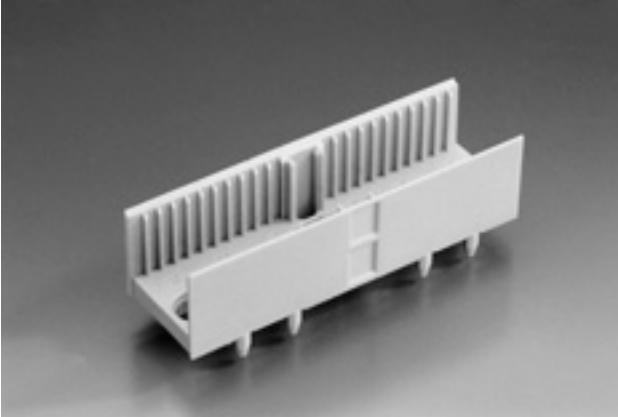

The ERmet type L male connector is an insulation body that could be loaded with up to 6 special power or coax contacts in a fully loaded configuration. The ERmet type L male connector has a multifunction cavity that incorporates pre-alignment guides and accepts optional coding keys. This connector is designed to be used alone or in conjunction with either a type B, C, M, or N ERmet connector. The type L male is available with a locating peg that helps secure the connector to the printed circuit board (PCB).

### Dimensional drawings and board hole pattern

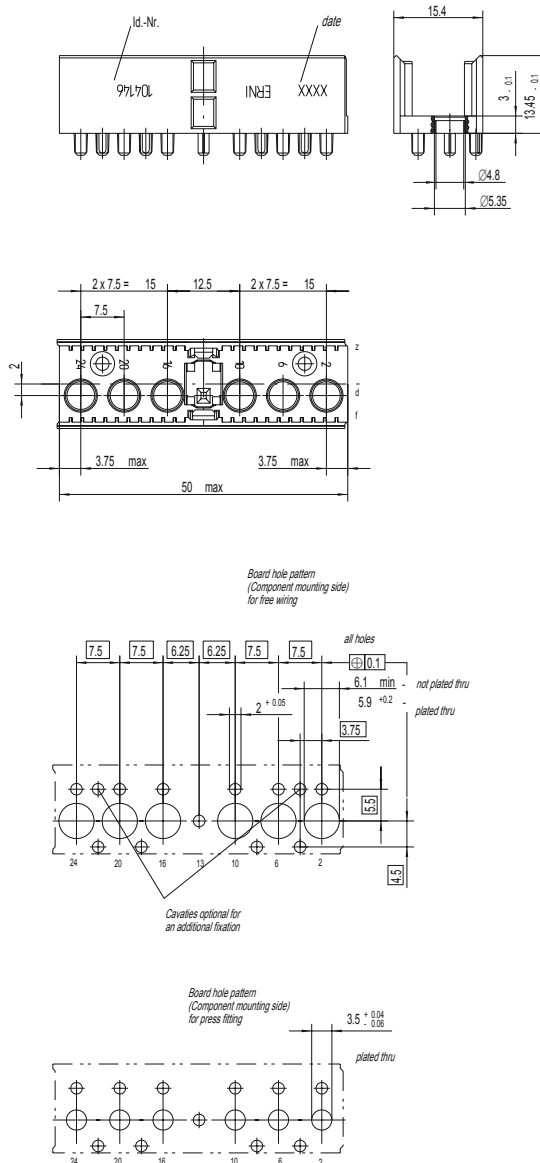

Note: The numbering on the connectors themselves is in accordance with the IEC 61076-4-101 standard. All dimensions in mm.

# Vertical Male Connectors Type L For Backplanes

## Ordering Information

Configuration	Used For	No. of Pins	Part Number
Type L with 6 cavities for special contacts			104146

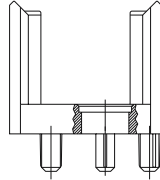
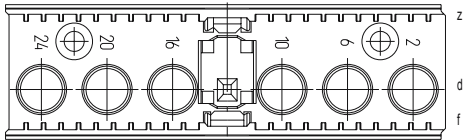

### Contact versions

ERNI can accommodate any pattern of male connector contact loading.  
 For shield rows z and f (7 row connectors) or z and y (10 row connectors), level 3 contacts should be specified. For rear I/O and shrouds, choose contacts with the R1, R2 or R3 terminal length. Each contact has a unique letter designation. Use this letter designation when filling in the contact loading requirements on the ERNI Customer Request Form.

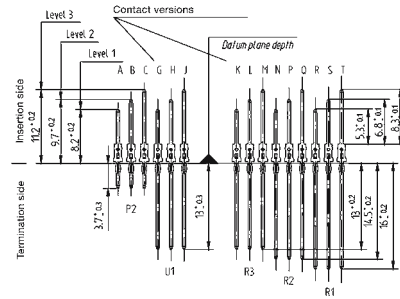



# Right Angle Female Connectors Type M For Daughter Cards

## Ordering Information

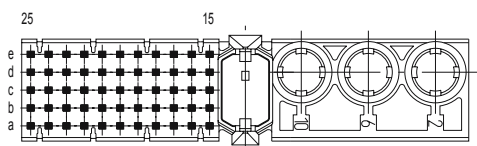
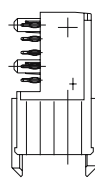
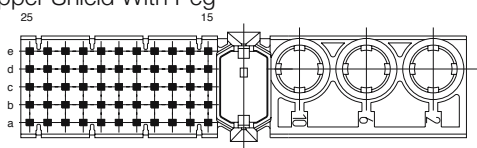
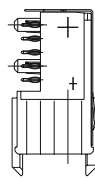
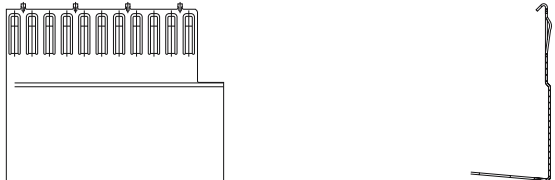
Configuration	Used For	No. of Pins	Part Number
<p>Type M With 3 Cavities For Special Contacts</p>  		55-3	<b>053792</b>
<p>Type M With 3 Cavities For Special Contacts With Upper Shield With Peg</p>  		55-3	<b>103804</b>
<p>Lower Shield For Type M</p> 			<b>054354</b>

## Vertical Male Connectors Type M For Backplanes

3 special and 55 signal contacts  
50 mm with multifunction block

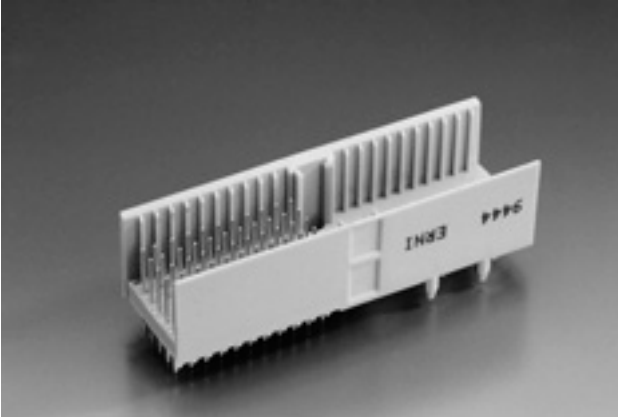

The ERmet male connector type M provides a maximum of 77 contacts in 7 rows by 11 positions. The two outer rows, z and f are for the shielding contacts of the male connector, along with 3 contact positions for special power or coax contacts. This type contains a multifunction cavity for coding and pre-alignment in the center position. This connector is designed to be used alone or in conjunction with either a type B, C, L, or N ERmet connector.

The type M male is available with a locating peg that helps secure the connector to the printed circuit board (PCB).

### Dimensional drawings and board hole pattern

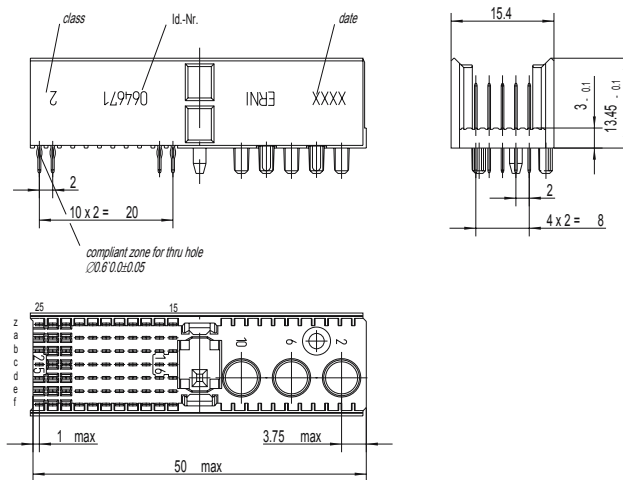

Board hole pattern  
(Component mounting side)

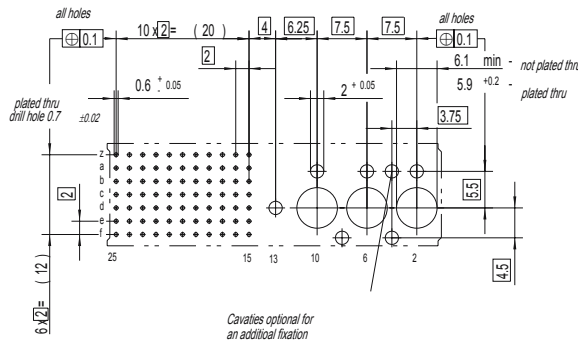

Cavities optional for an additional fixation

Board hole pattern  
(Component mounting side)  
for press-fitting

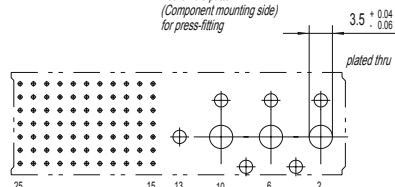

Note: The numbering on the connectors themselves is in accordance with the IEC 61076-4-101 standard. All dimensions in mm.



# Vertical Male Connectors Type M For Backplanes

## Ordering Information

Configuration	Used For	No. of Pins	Part Number
Type M With 3 Cavities For Special Contacts 		77-3	<b>054087</b>
Type M With 3 Cavities For Special Contacts 		55-3	<b>064671</b>

### Contact versions

ERNI can accommodate any pattern of male connector contact loading.

For shield rows z and f (7 row connectors) or z and y (10 row connectors), level 3 contacts should be specified. For rear I/O and shrouds, choose contacts with the R1, R2 or R3 terminal length. Each contact has a unique letter designation. Use this letter designation when filling in the contact loading requirements on the ERNI Customer Request Form.

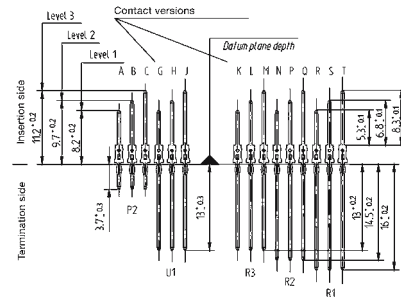



## Right Angle Female Connectors Type N For Daughter Cards

### Ordering Information

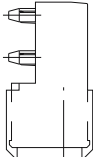
Configuration	Used For	No. of Pins	Part Number
Type N With 3 Cavities For Special Contacts			044581

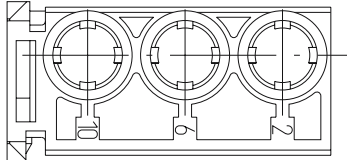

## Vertical Male Connectors Type N For Backplanes

3 cavities for special contacts  
25 mm extension module

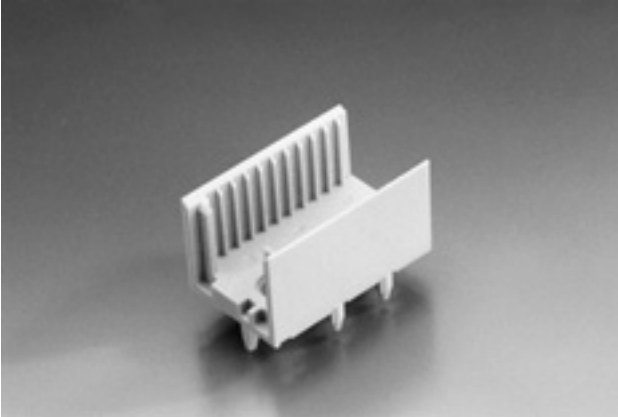

The ERmet type N male connector is a connector housing with 3 contact positions for special coax or high power contacts. The type N male is available with a locating and strain relief peg that helps secure the connector to the printed circuit board (PCB).

### Dimensional drawings and board hole pattern

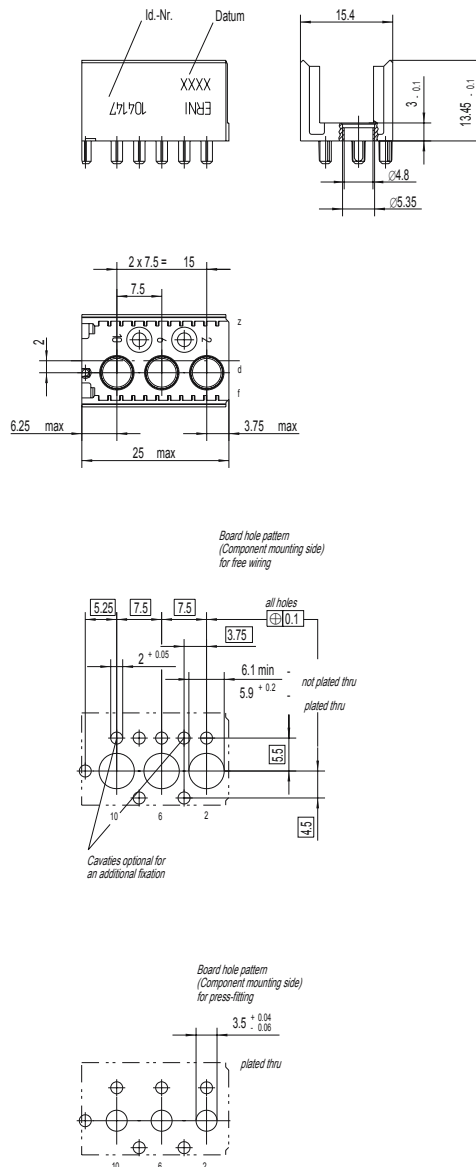

Note: The numbering on the connectors themselves is in accordance with the IEC 61076-4-101 standard. All dimensions in mm.

# Vertical Male Connectors Type N For Backplanes

## Ordering Information

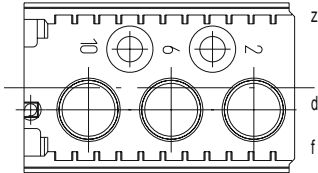
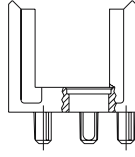
Configuration	Used For	No. of Pins	Part Number
3 cavities for special contacts  			<b>104147</b>

### Contact versions

ERNI can accommodate any pattern of male connector contact loading.

For shield rows z and f (7 row connectors) or z and y (10 row connectors), level 3 contacts should be specified. For rear I/O and shrouds, choose contacts with the R1, R2 or R3 terminal length. Each contact has a unique letter designation. Use this letter designation when filling in the contact loading requirements on the ERNI Customer Request Form.

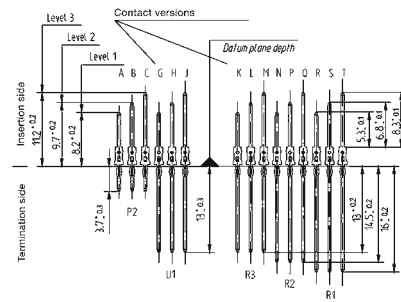

## Shrouds Type A For Backplanes

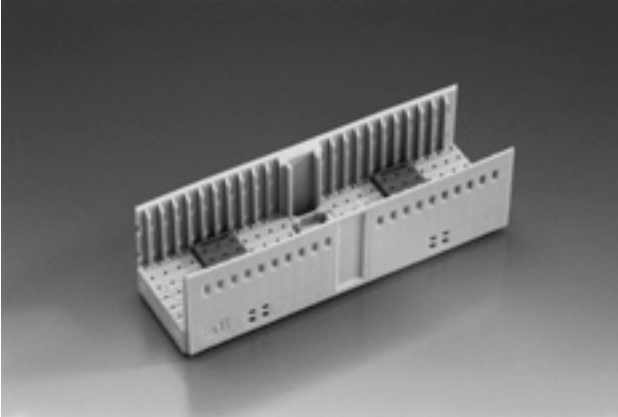

The ERmet shroud type A is possible for a maximum of 175 contacts in 7 rows by 25 positions. The two outer rows, z and f are for the shielding contacts of the female connector. This type contains a multifunction block for coding and pre-alignment which uses 3 positions.

For CompactPCI applications the shroud type A is used on the position rP1 and rP4.

### Dimensional drawings

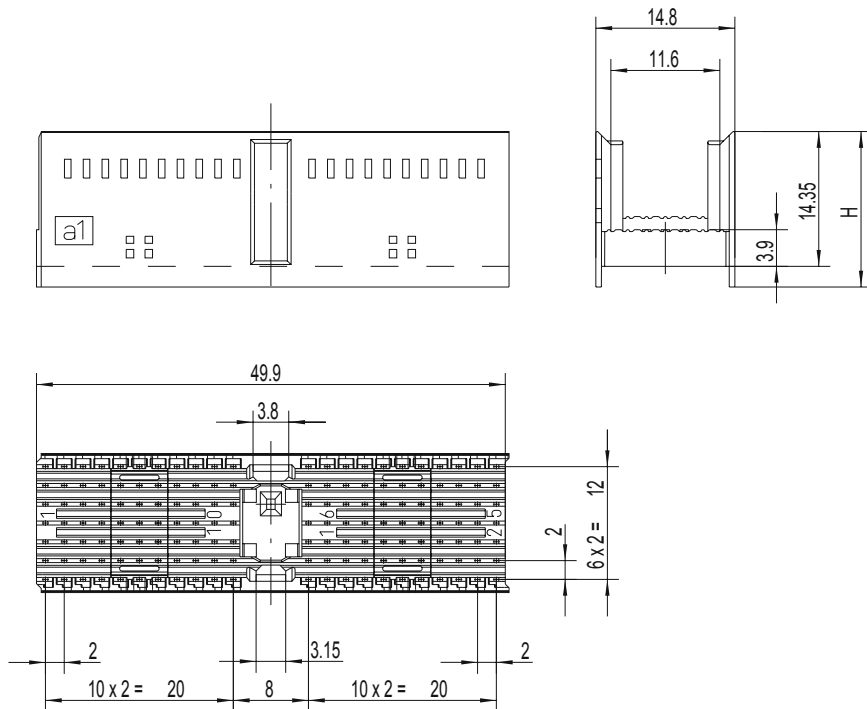

H	Ident-Nr. / Part No.
14.35	114436
14.95	054795
15.75	054794
16.55	054793

Sammelzeichnung  
Combination Drawing

Note: All dimensions in mm.

# Shrouds Type A For Backplanes

## Ordering Information

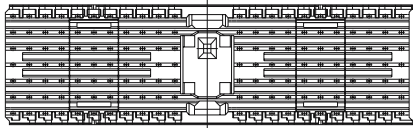
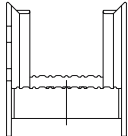
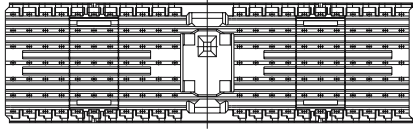
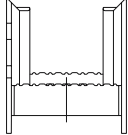
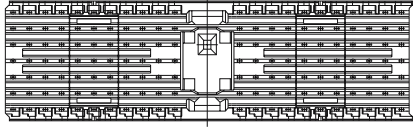
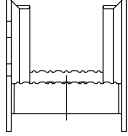
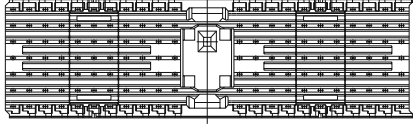
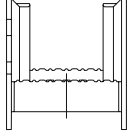
Configuration		Used For	No. of Pins	Part Number
Type A Shroud 25 Positions 	Height 14.35 	<b>CompactPCI™</b> rP1, rP4		<b>114436</b>
Type A Shroud 25 Positions 	Height 14.95 	<b>CompactPCI™</b> rP1, rP4		<b>054795</b>
Type A Shroud 25 Positions 	Height 15.75 	<b>CompactPCI™</b> rP1, rP4		<b>054794</b>
Type A Shroud 25 Positions 	Height 16.55 	<b>CompactPCI™</b> rP1, rP4		<b>054793</b>

## Shrouds Type A For Backplanes

### Ordering Information

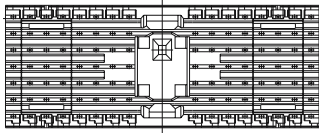
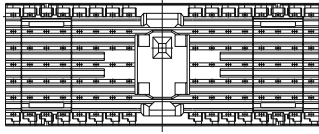
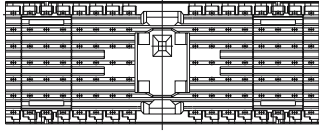
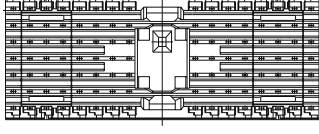
Configuration	Used For	No. of Pins	Part Number
Type A Shroud 19 Positions 	Height 14.35		<b>124312</b>
Type A Shroud 19 Positions 	Height 14.95		<b>923109</b>
Type A Shroud 19 Positions 	Height 15.75		<b>923108</b>
Type A Shroud 19 Positions 	Height 16.55		<b>923107</b>



## Shrouds Type B For Backplanes

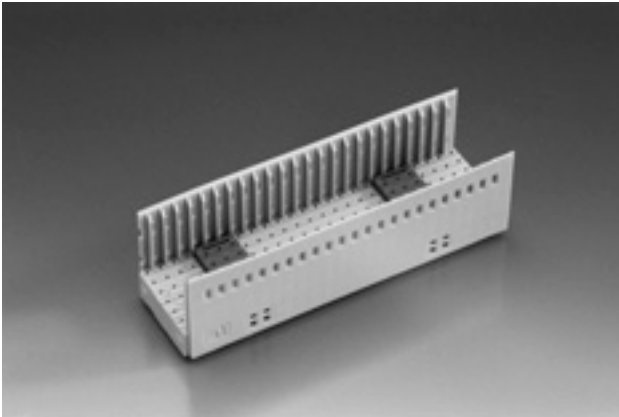

The ERmet™ shroud type B is possible for a maximum of 175 contacts in 7 rows by 25 positions. The two outer rows, z and f are for the shielding contacts of the female connector. For this type, without multifunction block for coding and pre-alignment, we recommend use only in combination with types A or C.

### Dimensional drawings

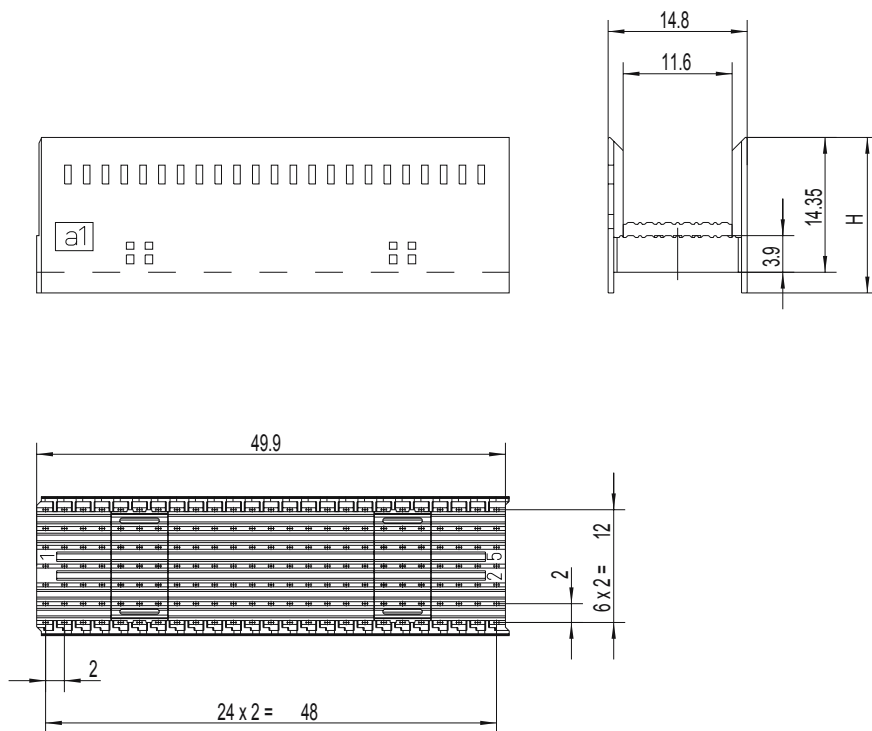

H	Ident-Nr. / Part No.
14.35	114437
14.95	054797
15.75	054798
16.55	054799

Sammelzeichnung  
Combination Drawing

Note: All dimensions in mm.

## Shrouds Type B For Backplanes

### Ordering Information

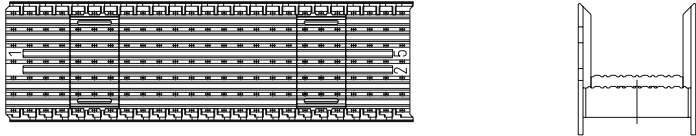
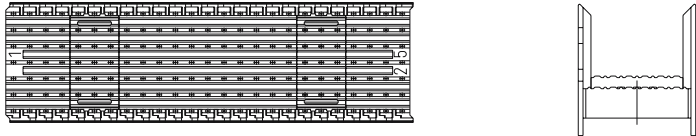
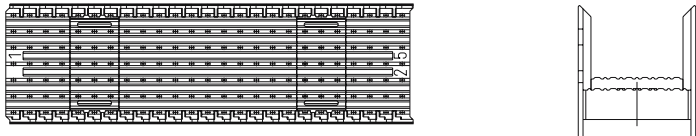
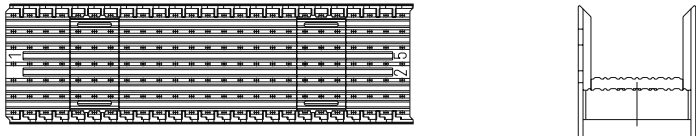
Configuration	Used For	No. of Pins	Part Number
Type B Shroud 25 Positions 	Height 14.35		<b>114437</b>
Type B Shroud 25 Positions 	Height 14.95		<b>054797</b>
Type B Shroud 25 Positions 	Height 15.75		<b>054798</b>
Type B Shroud 25 Positions 	Height 16.55		<b>054799</b>

# Shrouds Type B For Backplanes

## Ordering Information

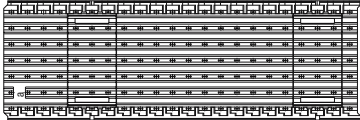
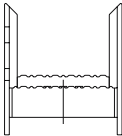
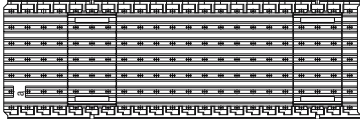
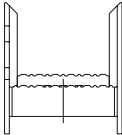
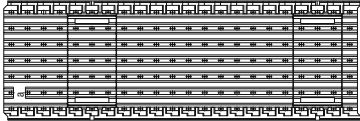
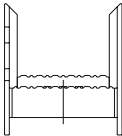
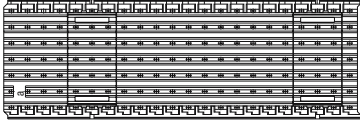
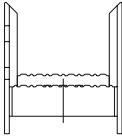
Configuration	Used For	No. of Pins	Part Number
Type B Shroud 22 Positions 	Height 14.35 		<b>114619</b>
Type B Shroud 22 Positions 	Height 14.95 		<b>064692</b>
Type B Shroud 22 Positions 	Height 15.75 		<b>064693</b>
Type B Shroud 22 Positions 	Height 16.55 		<b>064694</b>

## Shrouds Type B For Backplanes

### Ordering Information

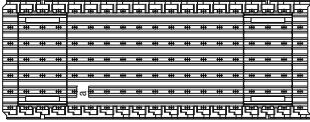
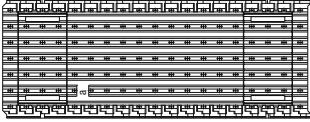
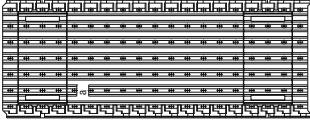
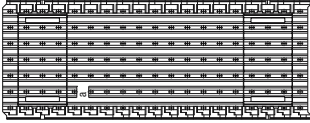
Configuration	Used For	No. of Pins	Part Number
Type B Shroud 19 Positions 	Height 14.35		<b>114618</b>
Type B Shroud 19 Positions 	Height 14.95		<b>064622</b>
Type B Shroud 19 Positions 	Height 15.75		<b>064623</b>
Type B Shroud 19 Positions 	Height 16.55		<b>064624</b>

## Shrouds Type C For Backplanes

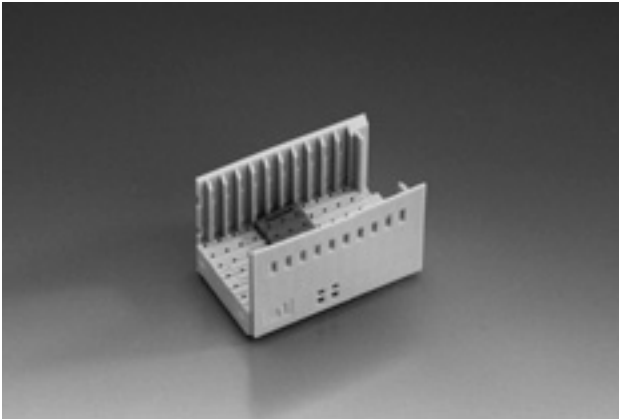

The ERmet shroud type C is possible for a maximum of 77 contacts in 7 rows by 11 positions with the length of 25 mm. The two outer rows, z and f are for the shielding contacts of the female connector.

### Dimensional drawings

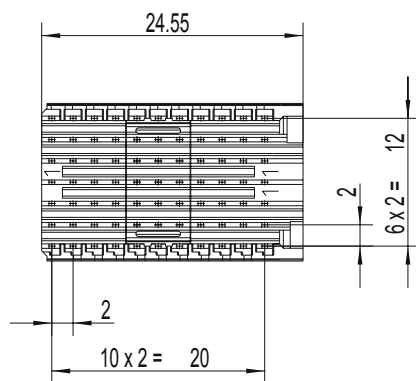
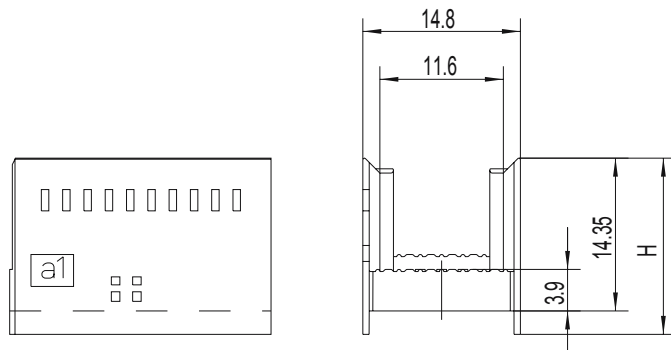

H	Ident-Nr. / Part No.
14.35	114438
14.95	064172
15.75	064171
16.55	064170

Sammelzeichnung  
Combination Drawing

Note: All dimensions in mm.

## Shrouds Type C For Backplanes

### Ordering Information

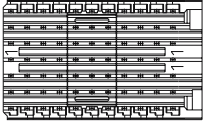
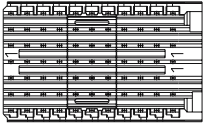
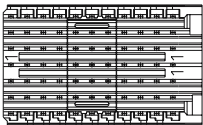
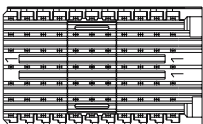
Configuration	Used For	No. of Pins	Part Number
Type C Shroud 11 Positions 	Height 14.35		114438
Type C Shroud 11 Positions 	Height 14.95		064172
Type C Shroud 11 Positions 	Height 15.75		064171
Type C Shroud 11 Positions 	Height 16.55		064170

## Shrouds Type AB For Backplanes

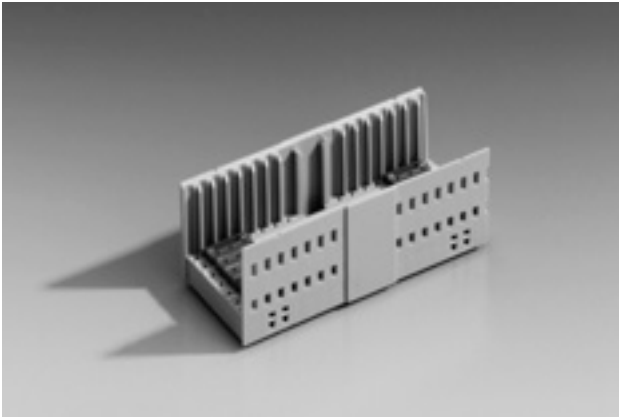

The ERmet shroud type AB is possible for a maximum of 169 contacts in 7 rows by 25 positions. The two outer rows, z and f are for the shielding contacts of the female connector. This type has pre-alignment flanges but no multi-function block for coding.

The male shroud type AB, is also available in a smaller version for planned CompactPCI applications, it is used at the locations rP2 and rP5 with 154, respectively, 110 contacts at 22 positions and on location rP3 with 133 respectively, 95 contacts at 19 positions.

### Dimensional drawings

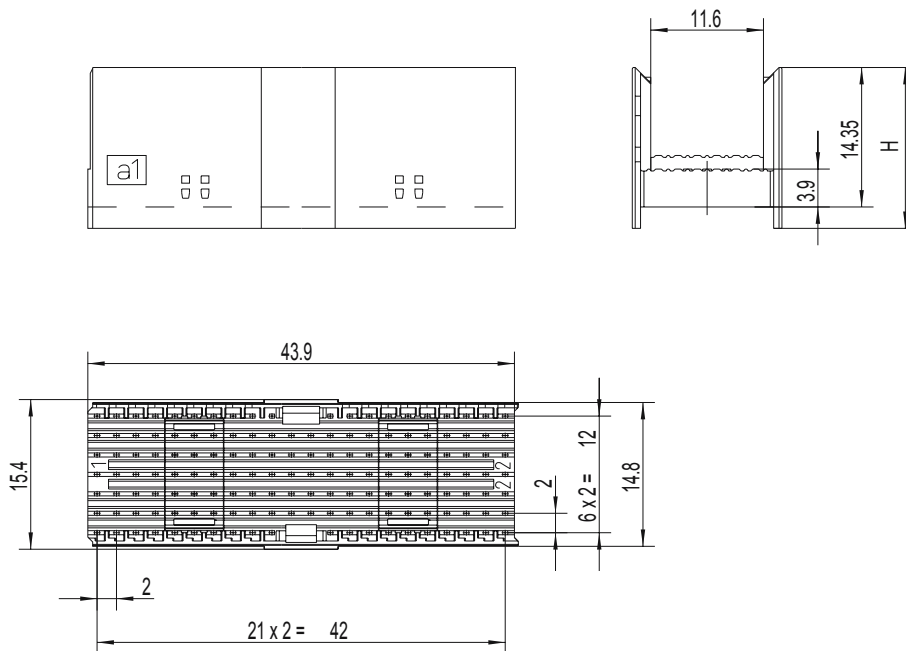

H	Ident-Nr. / Part No.
14.35	114425
14.95	114426
15.75	114427
16.55	114428

Sammelzeichnung  
Combination Drawing

Note: All dimensions in mm.

## Shrouds Type AB For Backplanes

### Ordering Information

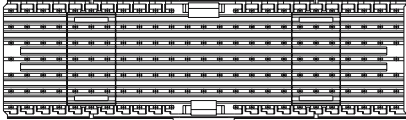
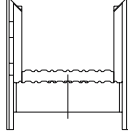
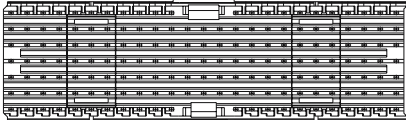
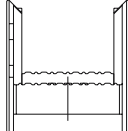
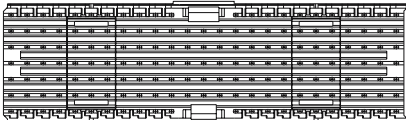
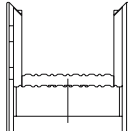
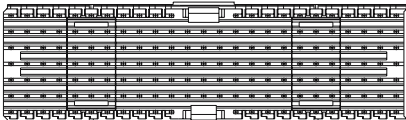
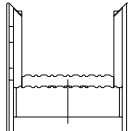
Configuration	Used For	No. of Pins	Part Number
Type AB Shroud 25 Positions 	Height 14.35 		114482
Type AB Shroud 25 Positions 	Height 14.95 		114483
Type AB Shroud 25 Positions 	Height 15.75 		114484
Type AB Shroud 25 Positions 	Height 16.55 		114485



## Shrouds Type AB For Backplanes

### Ordering Information

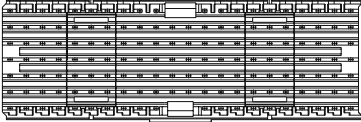
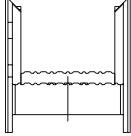
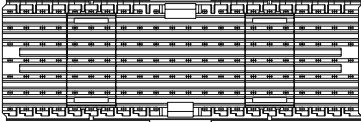
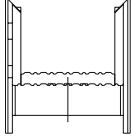
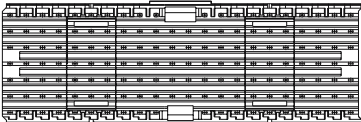
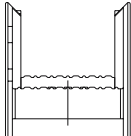
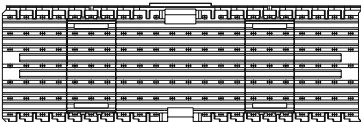
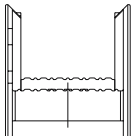
Configuration		Used For	No. of Pins	Part Number
Type AB Shroud 22 Positions	Height 14.35	<b>CompactPCI™</b>		
		rP2, rP5		<b>114425</b>
Type AB Shroud 22 Positions	Height 14.95	<b>CompactPCI™</b>		
		rP2, rP5		<b>114426</b>
Type AB Shroud 22 Positions	Height 15.75	<b>CompactPCI™</b>		
		rP2, rP5		<b>114427</b>
Type AB Shroud 22 Positions	Height 16.55	<b>CompactPCI™</b>		
		rP2, rP5		<b>114428</b>

## Shrouds Type AB For Backplanes

### Ordering Information

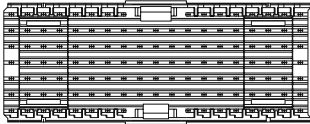
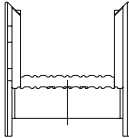
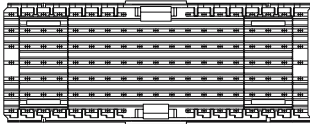
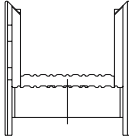
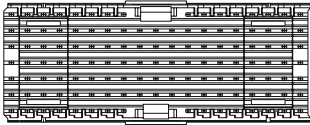
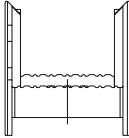
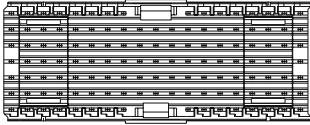
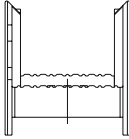
Configuration		Used For	No. of Pins	Part Number
Type AB Shroud 19 Positions	Height 14.35	<b>CompactPCI™</b>		
		rP3		<b>114487</b>
Type AB Shroud 19 Positions	Height 14.95	<b>CompactPCI™</b>		
		rP3		<b>114488</b>
Type AB Shroud 19 Positions	Height 15.75	<b>CompactPCI™</b>		
		rP3		<b>114489</b>
Type AB Shroud 19 Positions	Height 16.55	<b>CompactPCI™</b>		
		rP3		<b>114490</b>

## Shrouds Type D For Backplanes

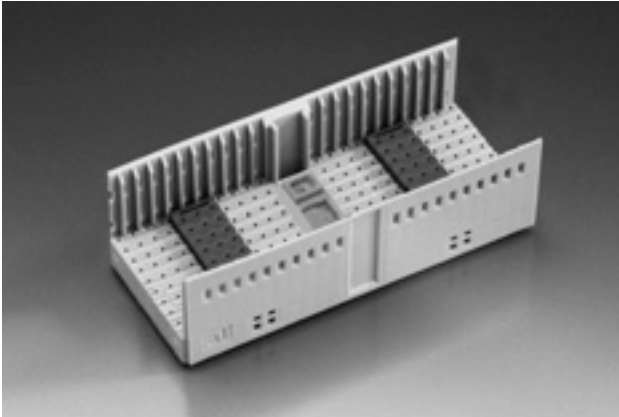

The ERmet shroud type D is possible for a maximum of 220 contacts in 10 rows by 25 positions with the length of 50 mm. The two outer rows, z and y are for the shielding contacts of the female connector. This type contains a multi-function block for coding and pre-alignment which uses 3 positions

### Dimensional drawings

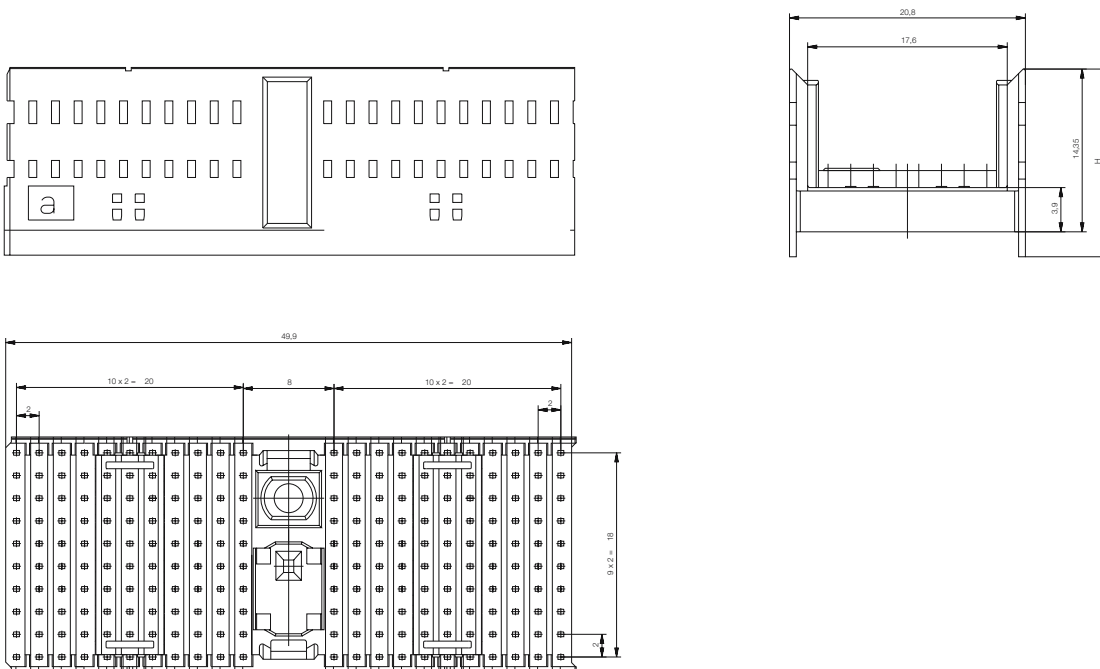

H	Ident-Nr. / Part No.
14.35	114467
14.95	114468
15.75	114469
16.55	114470

Note: All dimensions in mm.

## Shrouds Type D For Backplanes

### Ordering Information

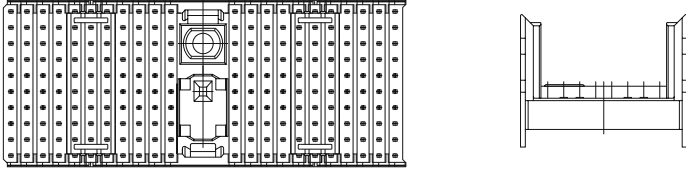
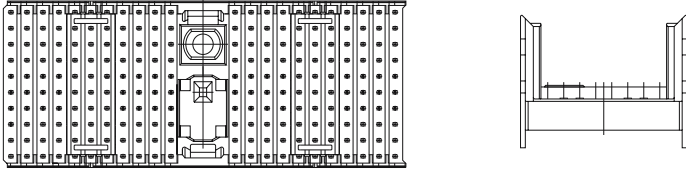
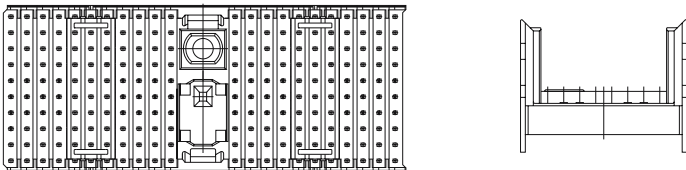
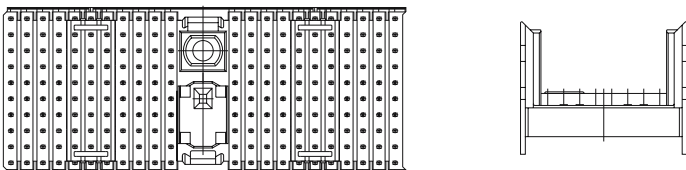
Configuration	Used For	No. of Pins	Part Number
Type D Shroud 25 Positions 	Height 14.35		114467
Type D Shroud 25 Positions 	Height 14.95		114468
Type D Shroud 25 Positions 	Height 15.75		114469
Type D Shroud 25 Positions 	Height 16.55		114470

# Shrouds Type E For Backplanes

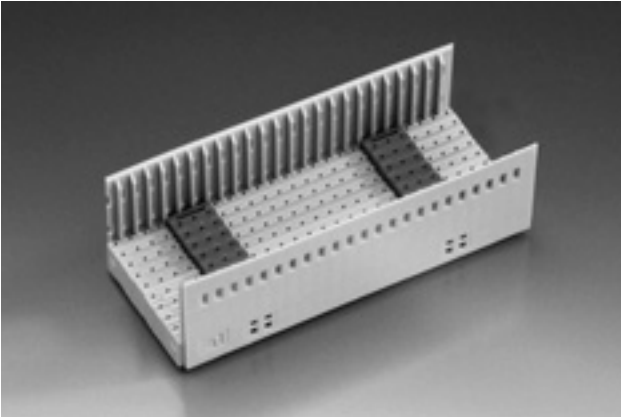

The ERmet shroud type E is possible for a maximum of 220 contacts in 10 rows by 25 positions with the length of 50 mm. The two outer rows, z and y are for the shielding contacts of the female connector. For this type; without multi-function block for coding and pre-alignment, we recommend use only in combination with types D or F.

## Dimensional drawings

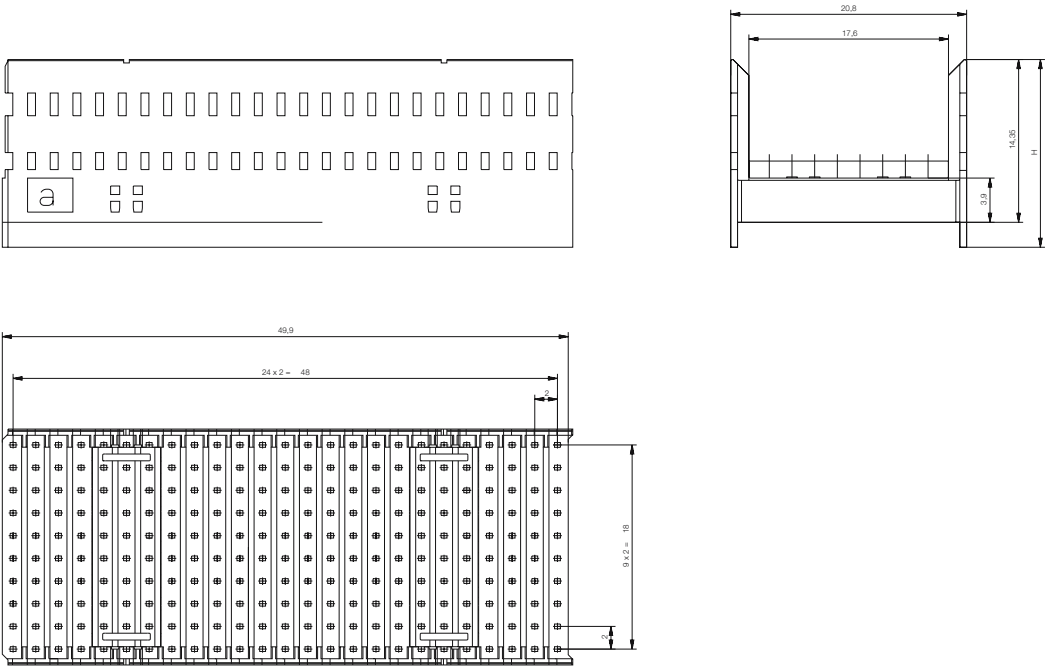

H	Ident-Nr. / Part No.
14.35	114472
14.95	114473
15.75	114474
16.55	114475

Note: All dimensions in mm.

## Shrouds Type E For Backplanes

### Ordering Information

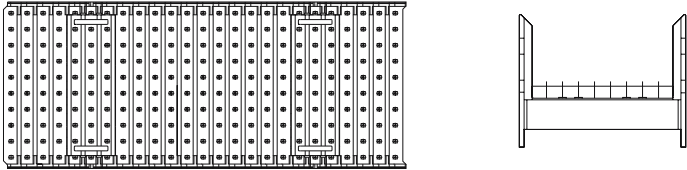
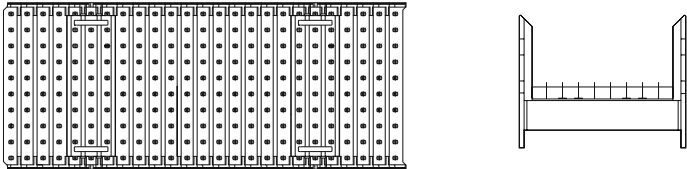
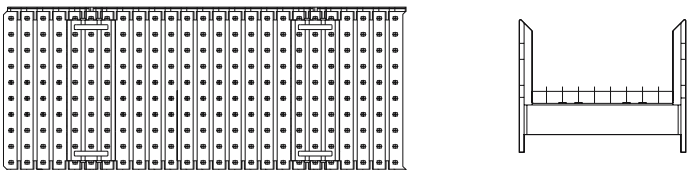
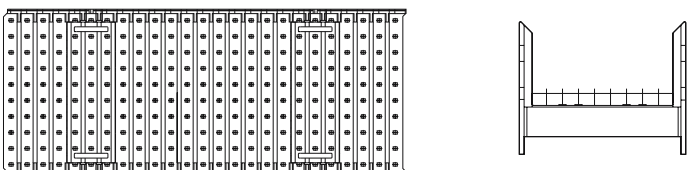
Configuration	Used For	No. of Pins	Part Number
Type E Shroud 25 Positions 	Height 14.35		114472
Type E Shroud 25 Positions 	Height 14.95		114473
Type E Shroud 25 Positions 	Height 15.75		114474
Type E Shroud 25 Positions 	Height 16.55		114475

## Shrouds Type F For Backplanes

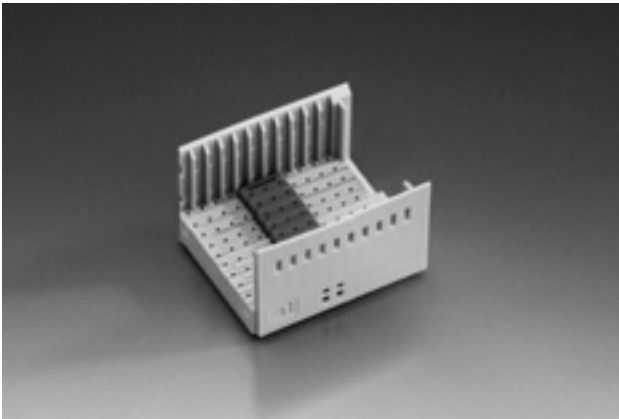

The ERmet shroud type F is possible for a maximum of 110 contacts in 10 rows by 11 positions with the length of 25 mm. The two outer rows, z and y are for the shielding contacts of the female connector.

### Dimensional drawings

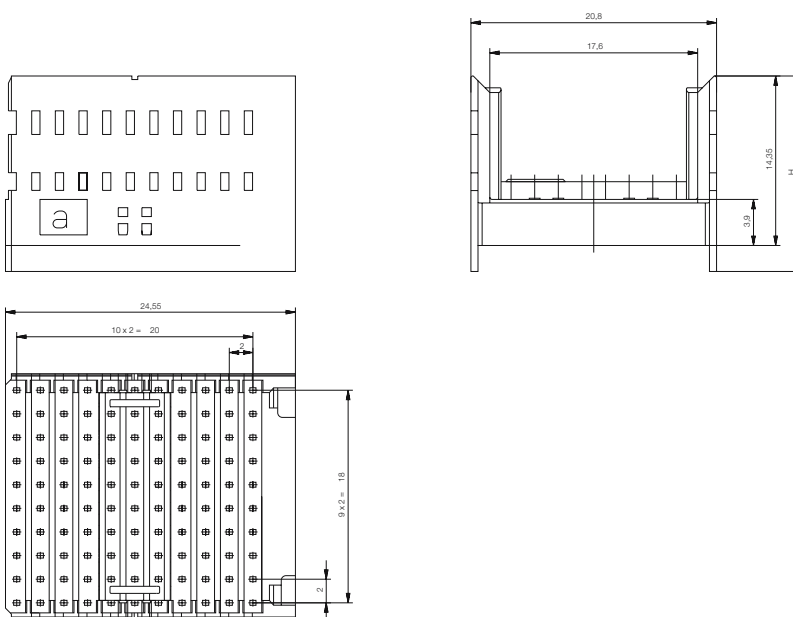

H	Ident-Nr. / Part No.
14.35	114477
14.95	114478
15.75	114479
16.55	114480

Note: All dimensions in mm.

## Shrouds Type F For Backplanes

### Ordering Information

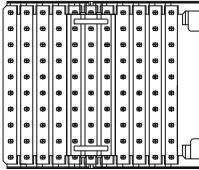
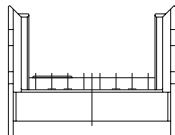
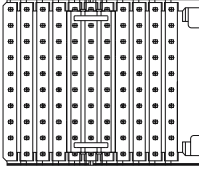
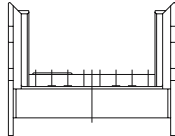
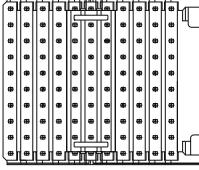
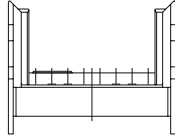
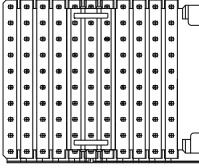
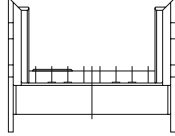
Configuration	Used For	No. of Pins	Part Number
Type F Shroud 11 Positions 	Height 14.35 		<b>114477</b>
Type F Shroud 11 Positions 	Height 14.95 		<b>114478</b>
Type F Shroud 11 Positions 	Height 15.75 		<b>114479</b>
Type F Shroud 11 Positions 	Height 16.55 		<b>114480</b>



# Right Angle Female Monoblock Modules

220 signal contacts  
94 mm with multifunction block

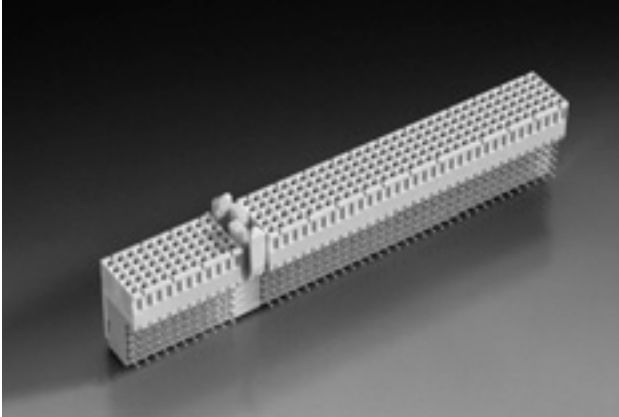

The ERmet™ female monoblock connector integrates the type A and the type B modules into one single piece. The monoblock provides a maximum of 220 contacts in 5 rows by 44 positions. The monoblock has integrated pre-centering and as an option integrated coding, acc. to PICMG Spec. for 3.3V or 5.0V, which requires 3 positions. For applications requiring the use of shielding, the female connector is supplied with a with an upper shield. Lower shield may be ordered separately. The monoblock has been designed especially for CompactPCI applications for the positions P1/P2 and for the positions P4/P5. The monoblock has a length of 94mm (3U) and can also be used for other applications in 19" rack systems.

## Dimensional drawings

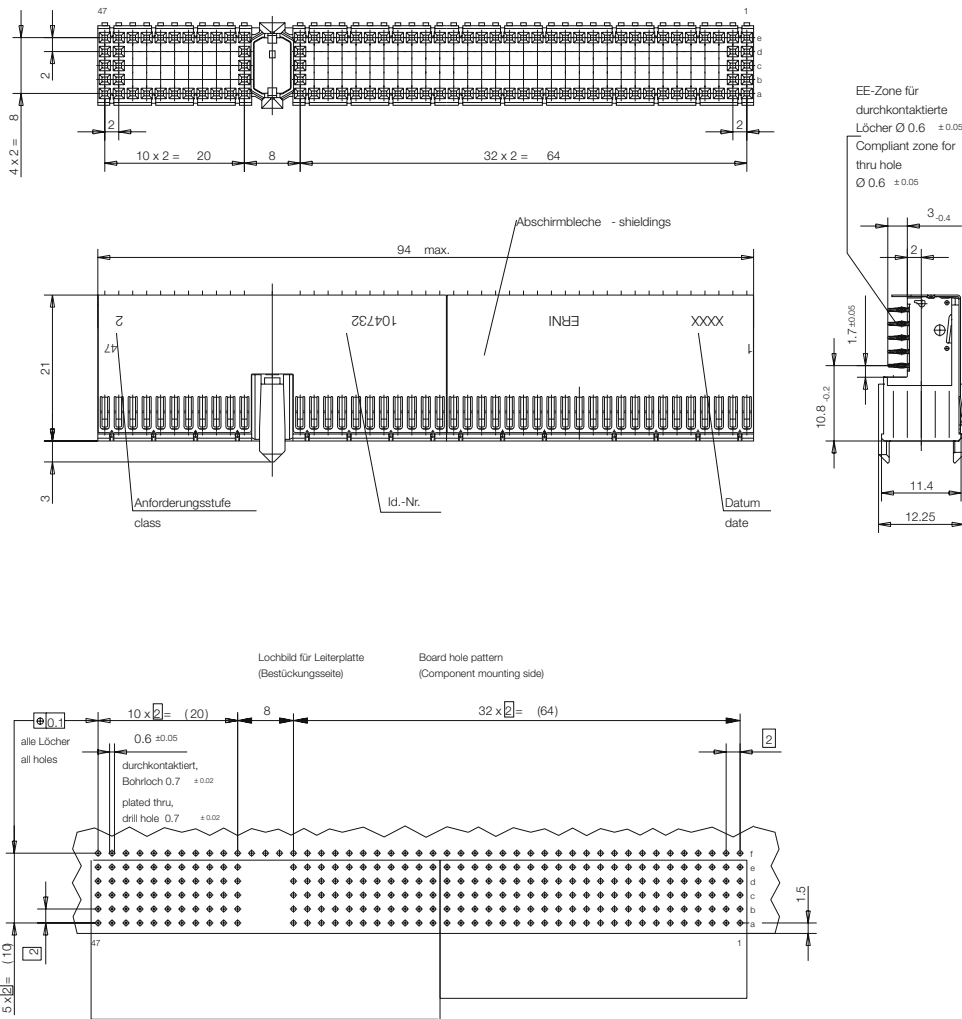

Note: The numbering on the connectors themselves is in accordance with the IEC 61076-4-101 standard. All dimensions in mm.

## Right Angle Female Monoblock Modules

### Ordering Information

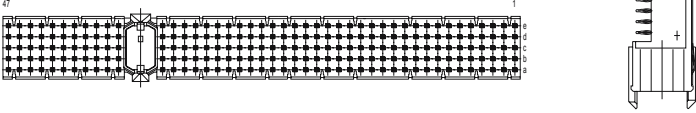
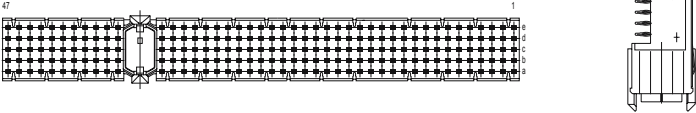
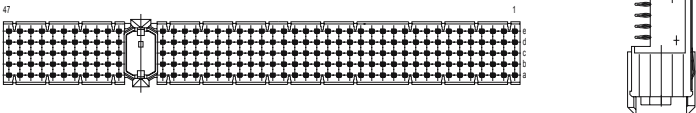
Configuration	Used For	No. of Pins	Part Number
Monoblock With Shield, Without Peg 	<b>CompactPCI™</b>  J4/J5	308	<b>104732</b>
Monoblock With Shield, Without Peg, With Cadmium Yellow Coding Key 	<b>CompactPCI™</b>  J4/J5	308	<b>104733</b>
Monoblock With Shield, Without Peg, With Brilliant Blue Coding Key 	<b>CompactPCI™</b>  J4/J5	308	<b>104734</b>

# Vertical Male Monoblock Modules

220 signal contacts  
94 mm with multifunction block



The ERmet™ vertical male monoblock connector integrates the type A and the type B in one single piece. The monoblock provides a maximum of 308 contacts in 7 rows by 44 positions. The two outer rows, z and f are for the shielding contacts of the female connector. The monoblock has integrated pre-centering and as option integrated coding acc. to PICMG Spec. for 3.3V or 5.0V, which requires 3 positions. The monoblock has been designed especially for CompactPCI applications. Available are versions with standard pin length for the positions P1 and P2 and versions with extended terminals for rear I/O for the positions P4 and P5. The monoblock has a length of 94mm (3U) and can also be used for other applications in 19" rack systems.

## Dimensional drawings

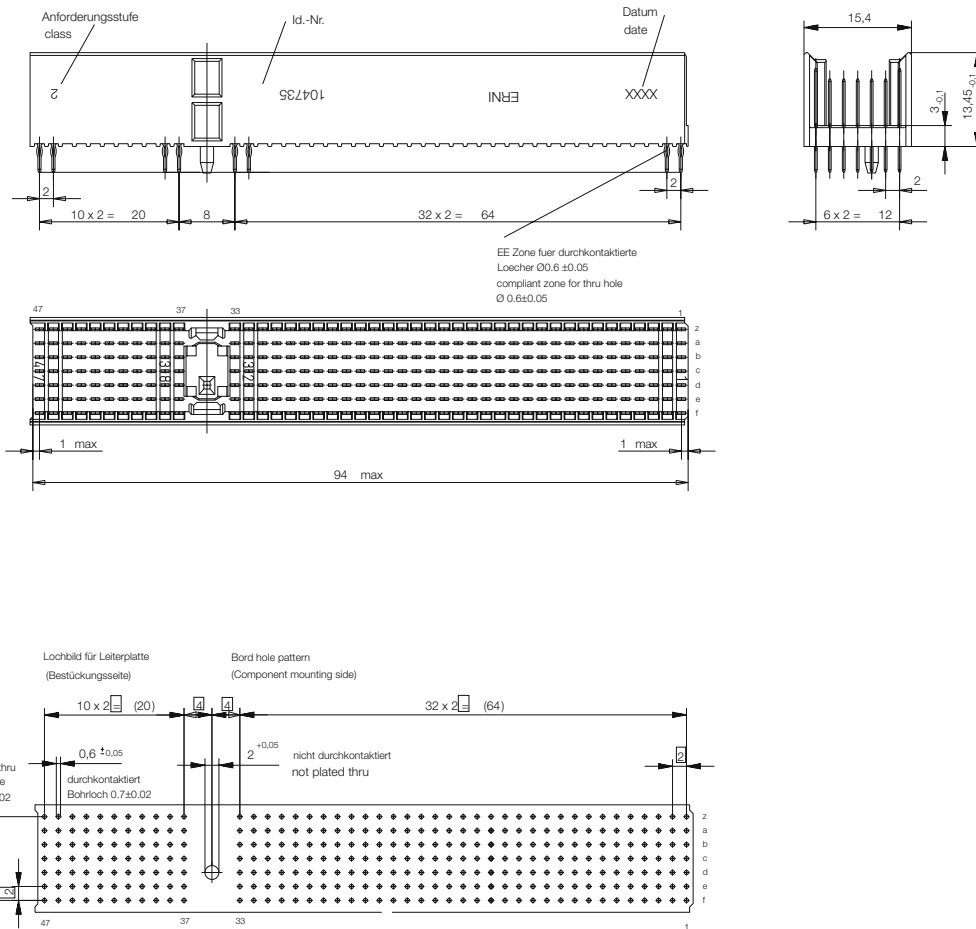

Note: The numbering on the connectors themselves is in accordance with the IEC 61076-4-101 standard. All dimensions in mm.

# Vertical Male Monoblock Modules

## Ordering Information

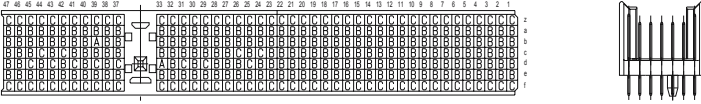
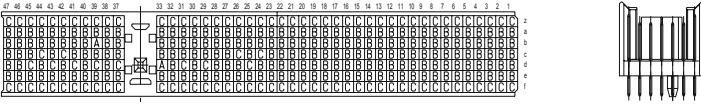
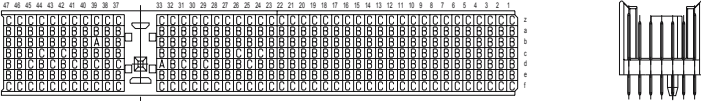
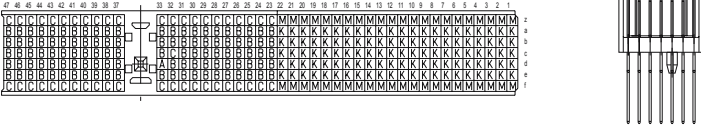
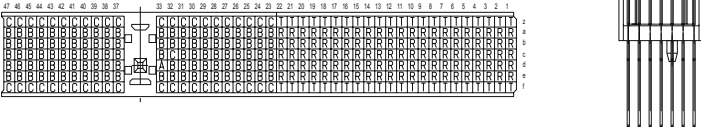
Configuration	Used For	No. of Pins	Part Number
Monoblock With Peg, With Shield 	<b>CompactPCI™</b> P1/P2	308	<b>104735</b>
Monoblock With Shield, Without Peg, With Cadmium Yellow Coding Key 	<b>CompactPCI™</b> P1/P2	308	<b>104736</b>
Monoblock With Shield, Without Peg, With Brilliant Blue Coding Key 	<b>CompactPCI™</b> P1/P2	308	<b>104737</b>
Monoblock With Peg, With Shield And With Extended Terminals 	<b>CompactPCI™</b> P1 Per PICMG 2.0 R 2.1 P2	308	<b>104765</b>
Monoblock With Peg, With Shield And With Extended Terminals 	<b>CompactPCI™</b> P1 Per PICMG 2.0 R 2.1 P2	308	<b>104766</b>

### Contact versions

ERNI can accommodate any pattern of male connector contact loading.

For shield rows z and f (7 row connectors) or z and y (10 row connectors), level 3 contacts should be specified. For rear I/O and shrouds, choose contacts with the R1, R2 or R3 terminal length. Each contact has a unique letter designation. Use this letter designation when filling in the contact loading requirements on the ERNI Customer Request Form.

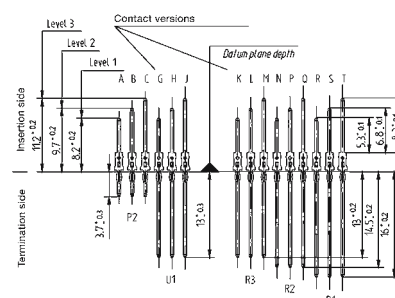

## Right Angle Male Power Modules For Daughter Cards

3 Power Contacts  
Width 12mm

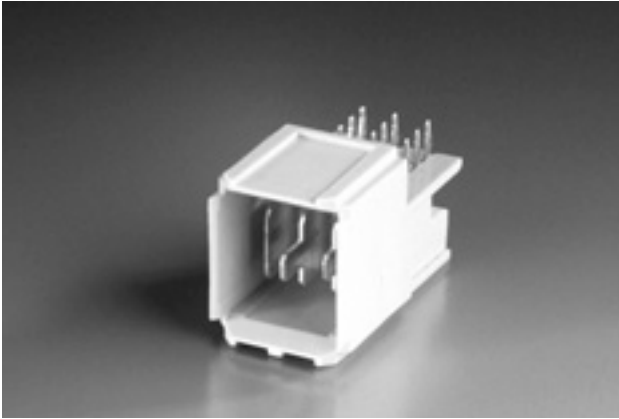

The ERmet™ 2mm HM power connector is used in conjunction with the ERmet™ 2mm HM signal connectors. It is also compatible with other popular 2mm HM connectors and the DIN 41612 family of connectors. This 12mm wide, right angle male connector provides up to three power contacts (9 amperes (20°C) each). The male contacts are available in three heights for early mate, late break hot swap applications.

This connector compliments the ERmet™ 2mm HM signal connectors by providing the safety of a closed entry female receptacle on the backplane and the right angle male header on the daughter card. This connector is designed to meet the IEC 950 finger probe safety requirements. The connector offers convenient pressfit assembly with inexpensive flat rock tooling. The pressfit hole requirements are the same as for the rest of the ERmet™ 2mm HM family.

### Dimensional drawings and board hole pattern

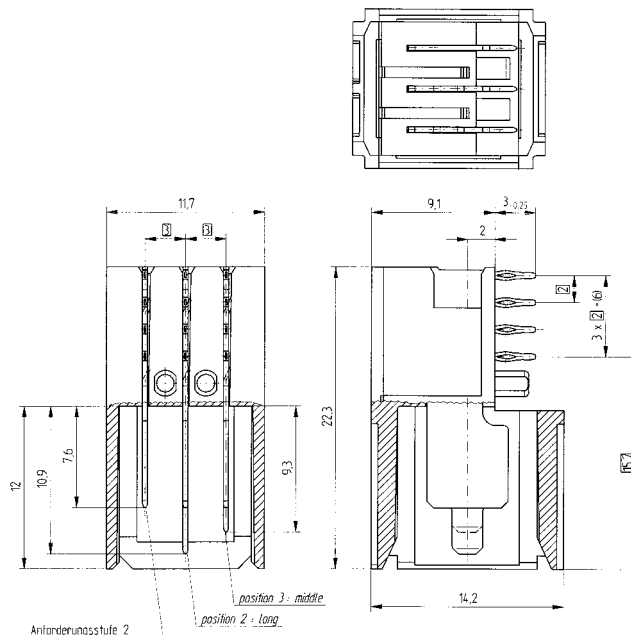
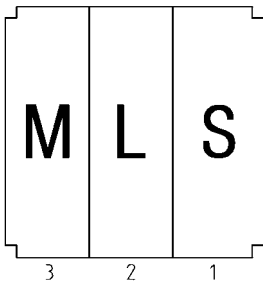

Anforderungsstufe 2  
class 2

Lochbild für Leiterplatte / Board hole pattern

<sup>1)</sup> Durchmesser des metallisierten Loches  
Diameter of finished plated-through hole



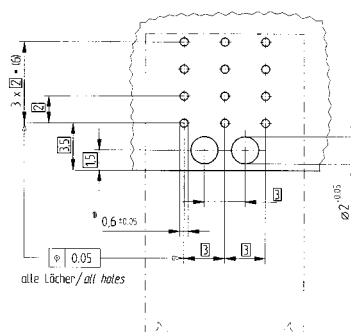

Ø0.7 ±0.02 Bohrungsdurchmesser des Loches  
Diameter of drilled hole

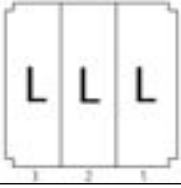
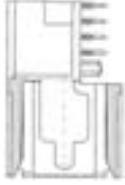

Note: All dimensions in mm

## Right Angle Male Power Modules For Daughter Cards

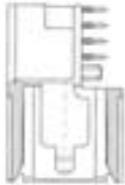
### Ordering Information

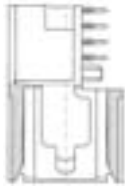
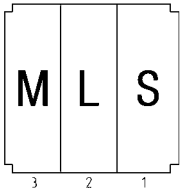
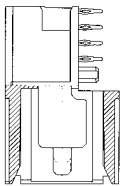
Configuration	Used For	No. of Pins	Part Number
Power Module With One Contact Level  		3	114400
Power Module With Two Contact Levels  		3	114401
Power Module With Two Contact Levels  		3	114402
Power Module With Three Contact Levels  		3	114403

## Vertical Female Power Modules For Backplanes

3 Power Contacts  
Width 10mm



The ERNI vertical female connector for backplanes provides a reliable, closed entry dual beam connection. This power connector is designed to be used in conjunction with the ERmet 2mm HM signal connectors. It is also compatible with other popular 2mm HM connectors and the DIN 41612 family of connectors. When used on a backplane this female receptacle connector eliminates any possibility of shorting power pins. This connector is designed to meet the IEC 950 finger probe safety requirements making it ideal for telecom and instrumentation applications.

This 10mm wide module provides three female contacts (8 amperes each) in a reliable press fit configuration. The pressfit hole requirements are the same as the rest of the ERmet signal connector family and the connector can be assembled with inexpensive pressfit tooling.

### Dimensional drawings and board hole pattern

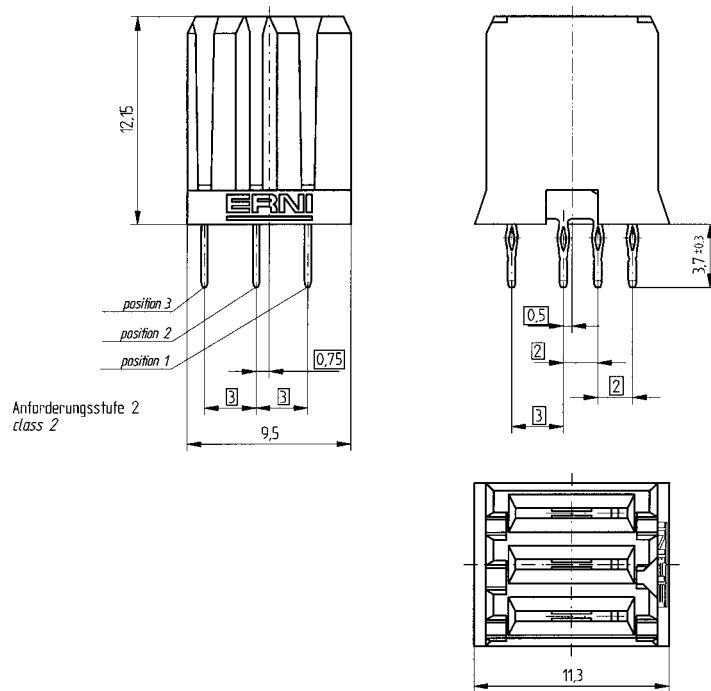

Lochbild für Leiterplatte / Board hole pattern

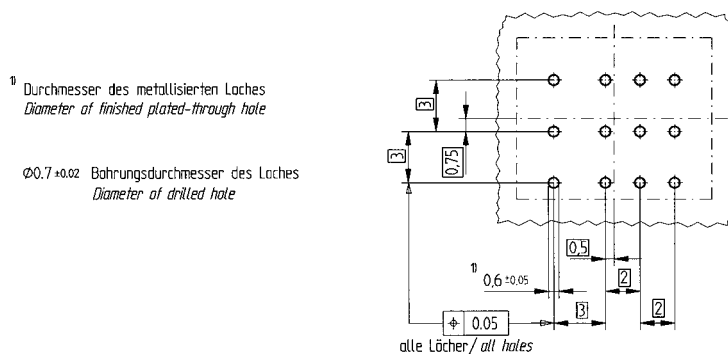

Note: All dimensions in mm

## Vertical Female Power Modules For Backplanes

### Ordering Information

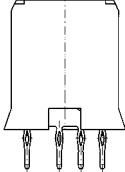
Configuration	Used For	No. of Pins	Part Number
Power Module		3	114404

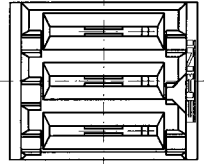

ERmet 2.0mm



## Dust Covers For Type A, B, AB, D, E and DE

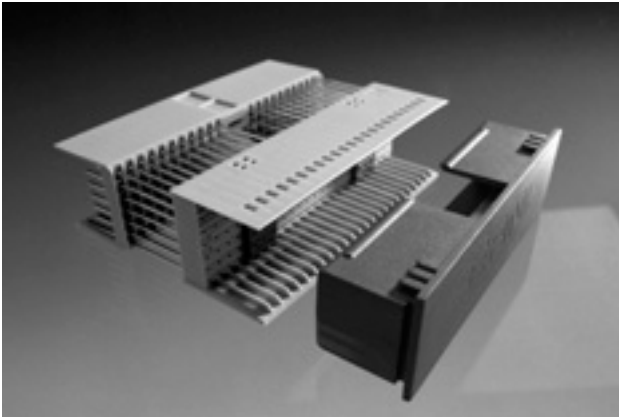

The dust and protection cover for the male connectors for the ERmet™ 2.0 mm connector system acc. to IEC 61076-4-101 protect the mating area at the frontside of the backplane and what is more important the transfer area on the reverse side of the backplane against damage of the contacts. They are also a protection for transportation and against dust. The dust and protection cover is available in two versions for type A, B, AB and for type D, E, DE with or without grip.

### Dimensional Drawings

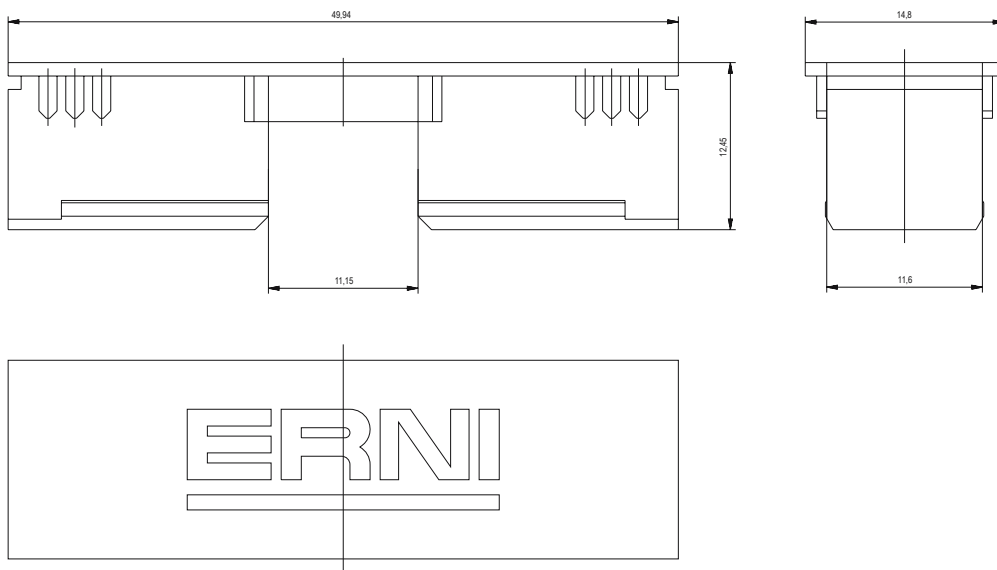

Note: All dimensions in mm

## Dust Covers For Type A, B, AB, D, E and DE

### Ordering Information

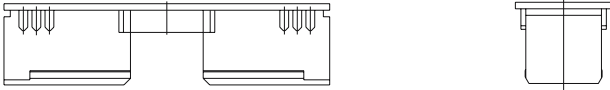
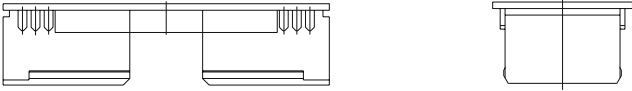
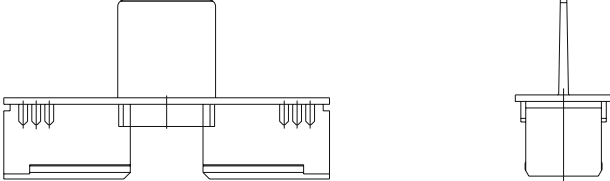
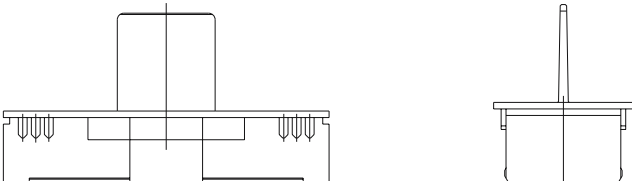
Configuration	Used For	No. of Pins	Part Number
A, B, AB Dust Cover Without Handle For Vacuum Pickup			104070
			
D, E, DE Dust Cover Without Handle For Vacuum Pickup			104939
			
A, B, AB Dust Cover With Handle For Hand Placement			114039
			
D, E, DE Dust Cover With Handle For Hand Placement			114040
			

## Coding Keys

### Ordering Information

#### Coding keys for male connectors and shrouds

Coding Key	Code No.	Colour	Part Number
	3568	Pastel Orange RAL 2003 Fincke 00233197	<b>043342</b>
	3478	Steel Blue RAL 5011 Fincke 00251197	<b>043343</b>
	3467	Slate Grey RAL 7015 Fincke 00235197	<b>043344</b>
	3456	Cadmium Yellow RAL 1021 Fincke 00252197	<b>043345</b>
	2578	Reseda Green RAL 6011 Fincke 00237197	<b>043346</b>
	1567	Brilliant Blue RAL 5007 Fincke 00245197	<b>043347</b>
	1356	Blue/Lilac RAL 4005 Fincke 00246197	<b>043348</b>
	4678	Ocher Yellow RAL 1024 Fincke 00313197	<b>043349</b>
	1248	Strawberry Red RAL 3018 Fincke 00312197	<b>043350</b>
	1236	Nut Brown RAL 8011 Fincke 00272197	<b>043351</b>

#### Coding keys for female connectors

Coding Key	Code No.	Colour	Part Number
	1247	Pastel Orange RAL 2003 Fincke 00233197	<b>043332</b>
	1256	Steel Blue RAL 5011 Fincke 00251197	<b>043333</b>
	1258	Slate Grey RAL 7015 Fincke 00235197	<b>043334</b>
	1278	Cadmium Yellow RAL 1021 Fincke 00252197	<b>043335</b>
	1346	Reseda Green RAL 6011 Fincke 00237197	<b>043336</b>
	2348	Brilliant Blue RAL 5007 Fincke 00245197	<b>043337</b>
	2478	Blue/Lilac RAL 4005 Fincke 00246197	<b>043338</b>
	1235	Ocher Yellow RAL 1024 Fincke 00313197	<b>043339</b>
	3567	Strawberry Red RAL 3018 Fincke 00312197	<b>043340</b>
	4578	Nut Brown RAL 8011 Fincke 00272197	<b>043341</b>
		Mounting Device For Coding-Keys	<b>053593</b>

## Guide Pin For ERmet 10 Row Type D



The optional applicable guide pin for the 10 row ERmet type D connector made of stainless steel is suited for the secure pre-centering when mating. The guide pin will be screwed with the connector and the pcb after the male connector has been pressed-in.

### Ordering Information

Description	Part Number
Guide Pin	104790
Toothed Lock Washer	104788
Hexagon Nut #2-56 UNC-2A	104789
Kit (Including Guide Pin, Toothed Lock Washer and Hexagon Nut)	104791

## Special Contacts For Type L, M And N



### Ordering Information For Coax Contacts

Characteristic Impedance	Contact Version	Cable Type	Part Number
50 Ohm	Male; Crimp-Version	RG 178 B/U; RG 196 A/U	013686
50 Ohm	Female; Crimp-Version	RG 178 B/U; RG 196 A/U	013687
50 Ohm	Male; PCB-Solder-Version; Right Angle		053299
50 Ohm	Female; Crimp-Version	RG 316 Protected	053395
50 Ohm	Male; Crimp-Version	RG 316 Protected	053400
50 Ohm	Female; Crimp-Version	RG 174 /U; RG 188 A/U; RG 316 /U	054238
50 Ohm	Male; Press-Fit-Version; Right Angle		104875
50 Ohm	Female; Crimp-Version	RG 174 /U; RG 188 A/U; RG 316 /U	594207
50 Ohm	Male; Crimp-Version	RG 174 /U; RG 188 A/U; RG 316 /U	594213
50 Ohm	Female; Press-Fit-Version R1		914382
75 Ohm	Male; PCB-Solder-Version; Right Angle		053306
75 Ohm	Male; Crimp-Version	RG 179 B/U; RG 187 A/U	053408
75 Ohm	Female; Crimp-Version	RG 179 B/U; RG 187 A/U	053410

### Ordering Information for High Power Contacts

Max. Current	Contact Version	Comments	Part Number
10 A	Female; Crimp-Version		594178
20 A	Female; Crimp-Version		594180
30 A	Female; Crimp-Version		053452
40 A	Female; Crimp-Version		594182
40 A	Female; Press-Fit-Version R3		044965
10 A	Female; Solder-Version		594172
20 A	Female; Solder-Version		594174
40 A	Female; Solder-Version		594176
40 A	Female; Solder-Version; Right Angle		053298
10 A	Male; Crimp-Version		594227
20 A	Male; Crimp-Version	First Made Last Break; Only Usable With Part No. 044965	053430
20 A	Male; Crimp-Version		594229
30 A	Male; Crimp-Version		033319
40 A	Male; Crimp-Version		594231
10 A	Male; Press-Fit-Version R1	First Made Last Break	103855
40 A	Male; Press-Fit-Version R1	First Made Last Break; Only Usable With Part No. 044965	044846
40 A	Male; Press-Fit-Version R1		044847
10 A	Male; Solder- Version		594221
20 A	Male; Solder- Version		594223
40 A	Male; Solder- Version		594225
10 A	Male; Solder-Version	First Made Last Break; Only Usable With Part No. 044965	053444

## Modular press-fit tools for male and female connectors

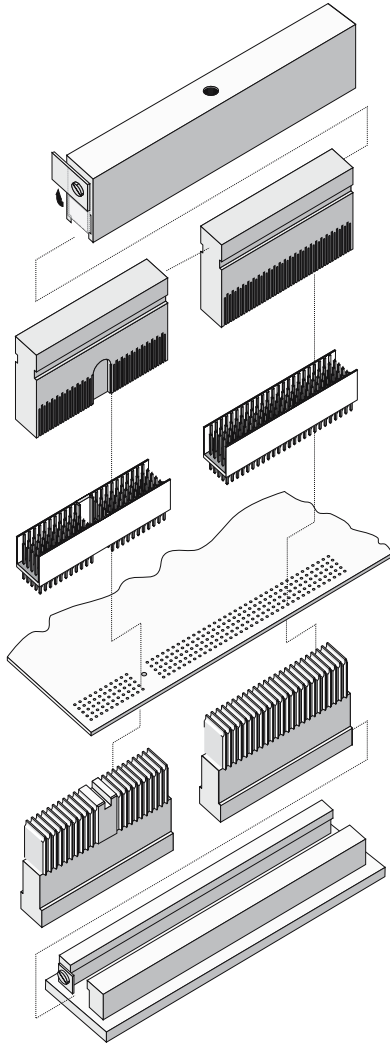

*Modular press-fit tool male connector modules 5+2*

ERmet connectors can be end to end mounted in modular layout. To be able to press-fit the selected connector layout for your application in a rationalized way, we have designed the necessary press-fit tools to be modular too. This is true of the tools both for male connectors and for female connectors. The tool bases, also termed anvils, are fixed in a tool holder. Each connector module requires an appropriately sized tool module.

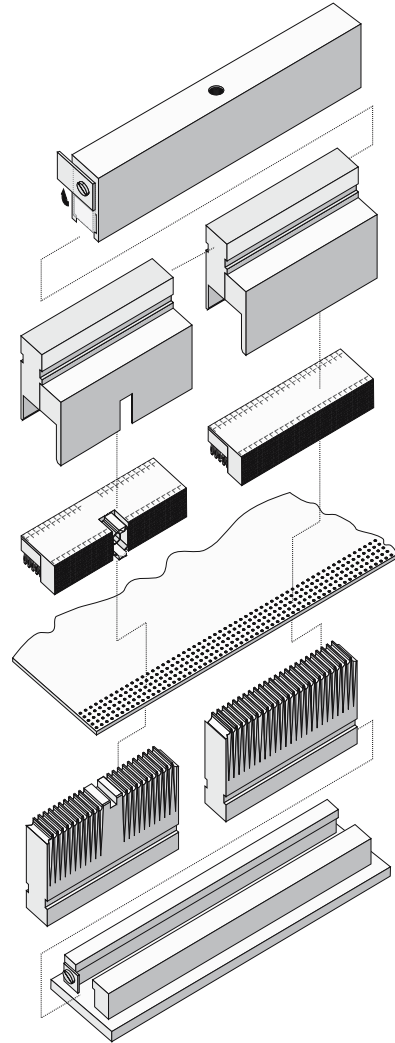

*Modular press-fit tool for female connector modules 5+2*

The standard tool holders are designed for two 50 mm modules (modules A, B, L and M), press-fitting a total module length of 100 mm. Due to the modular tool configuration, press-fitting can be carried out in any order. Using filler elements, it is also possible to press-fit just individual modules.

For details on how to order press-fit tools, please contact the factory.

## Press-In-Tools For The Female Connectors

### Ordering Information

Design	Module	Upper Tools	Lower Tools	Comments
Female	A	220006	220020	Standard
Female	B/AB	220006	220021	Standard
Female	C	220007	220022	Standard
Female	L	220008	220023	Standard; High Power Contact, Press-fit
Female	L	220008	220402	Standard; Coax-Contact, Press-fit
Female	M	220009	220024	Standard; High Power Contact, Press-fit
Female	M	220009	220323	Standard; Coax-Contact, Press-fit
Female	M	220009	220415	Standard; Coax-Contact, Solder
Female	N	220010	220025	Standard; High Power Contact, Press-fit
Female	N	220010	220287	Standard; Coax-Contact, Press-fit
Female	A	220093	220020	Upper Shield
Female	B/AB	220093	220021	Upper Shield
Female	C	220096	220022	Upper Shield
Female	M	220322	220024	Upper Shield ; High Power Contact, Press-fit
Female	M	220322	220323	Upper Shield ; Coax- Contact, Press-fit
Female	A	220436	220437	Lower Shield
Female	A/AB	220436	220437	Lower Shield
Female	C	220453	220454	Lower Shield
Female	D	220253	220250	Standard
Female	E/DE	220253	220251	Standard
Female	F	220254	220252	Standard
Female	D	220256	220250	Upper Shield
Female	E/DE	220256	220251	Upper Shield
Female	F	220257	220252	Upper Shield
Female	D	220455	220458	Lower Shield
Female	E/DE	220455	220456	Lower Shield
Female	F	220457	220458	Lower Shield
Female	B19/AB19	220175	220176	VME/64
Female	B19/AB19	220179	220176	VME/64 Upper Shield
Female	B19/AB19	220449	220450	VME/64 Lower Shield
Female	B22/AB22	220183	220184	PCI
Female	B22/AB22	220187	220184	PCI Upper Shield
Female	B22/AB22	220451	220452	PCI Lower Shields
Vertical Fem.	A	220204	220026	Standard
Vertical Fem.	B	220204	220027	Standard
Vertical Fem.	B19	220356	220174	VME/64
Vertical Fem.	B22	220357	220182	PCI
Vertical Fem.	C	220341	220028	Standard
Vertical Fem.	D	220477	220247	Standard
Vertical Fem.	E	220477	220248	Standard
Vertical Fem.	F	220478	220249	Standard
Female	Power Mod.	220383	220384	

## Press-In-Tools For The Male Connectors

### Ordering Information

Design	Module	Upper Tools	Lower Tool	Comment
Male	A	<b>220011</b>	<b>220026</b>	Standard
Male	A	<b>220469</b>	<b>220026</b>	Standard; Integrated Coding
Male	B	<b>220012</b>	<b>220027</b>	Standard
Male	AB25	<b>220376</b>	<b>220182</b>	Standard
Male	AB22	<b>220401</b>	<b>220182</b>	Standard
Male	AB19	<b>220400</b>	<b>220174</b>	Standard
Male	C	<b>220013</b>	<b>220028</b>	Standard
Male	L	<b>220014</b>	<b>220029</b>	Standard; High Power Contact, Press-fit
Male	L	<b>220420</b>	<b>220421</b>	Standard; Coax-Contact, Press-fit
Male	M	<b>220015</b>	<b>220030</b>	Standard; High Power Contact, Press-fit
Male	M	<b>220422</b>	<b>220423</b>	Standard; Coax-Contact, Press-fit
Male	N	<b>220016</b>	<b>220031</b>	Standard; High Power Contact, Press-fit
Male	N	<b>220424</b>	<b>220425</b>	Standard; Coax-Contact, Press-fit
Male	B19	<b>220173</b>	<b>220174</b>	VME/64
Male	B22	<b>220181</b>	<b>220182</b>	PCI
Male	D	<b>220244</b>	<b>220247</b>	Standard
Male	E	<b>220245</b>	<b>220248</b>	Standard
Male	F	<b>220246</b>	<b>220249</b>	Standard
Male	DE	<b>220410</b>	<b>220248</b>	Standard
Male	Power Mod.	<b>220385</b>	<b>220386</b>	

## Toolholder

### Ordering Information

Description	Part Number	Length	Comment
Holder Upper Tool	<b>220001</b>	100mm long	with mounting pivot Ø 20
Holder Upper Tool	<b>220002</b>	100 mm long	with quick change
Holder Upper Tool	<b>220188</b>	150 mm long	with mounting pivot Ø 20
Holder Upper Tool	<b>220003</b>	150 mm long	with quick change
Holder Upper Tool	<b>220004</b>	250 mm long	with mounting pivot Ø20
Holder Upper Tool	<b>220005</b>	250 mm long	with quick change
Holder Lower Tool	<b>220191</b>	100 mm long	for lowerable table
Holder Lower Tool	<b>220267</b>	150 mm long	for lowerable table
Holder Lower Tool	<b>220268</b>	250 mm long	for lowerable table



### 3U CompactPCI® Daughter Card Layout

The 3U CompactPCI® backplane and daughter card layouts are provided to clarify the contact numbering and connector nomenclature used within the specification. As is typical of some telecommunication applications, the CompactPCI® specification numbers the signals and

connectors from the bottom up. Manufacturers and users should note that the connectors themselves are labeled in accordance to IEC 61076-4-101 and prevailing industry practice from the top down.

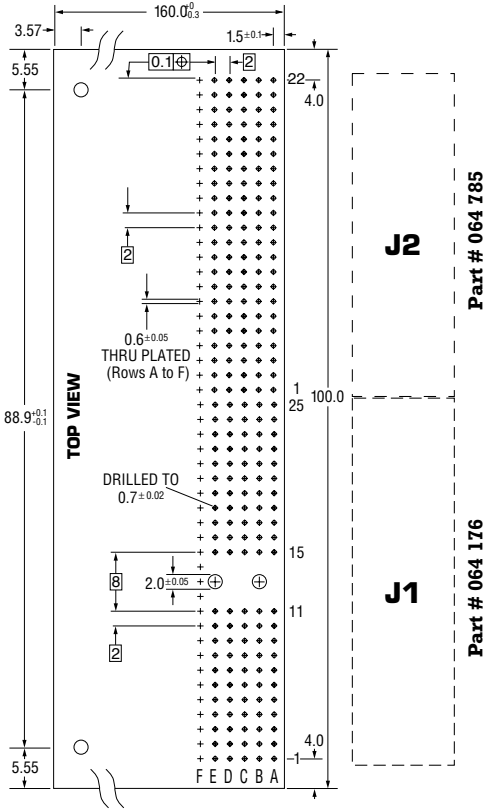

Note that the backplane and daughter card are numbered in accordance with the CompactPCI® specification. The numbering on the connectors themselves is different and in accordance with the IEC 61076-4-101 standard. All dimensions are in millimeters (mm) unless otherwise noted.

### 3U CompactPCI® Backplane Layout

The 3U CompactPCI® backplane layout is provided to clarify the contact numbering and connector nomenclature used within the specification.

As is typical of some telecommunication applications, the CompactPCI® specification numbers the signals and con-

nectors from the bottom up. Manufacturers and users should note that the connectors themselves are labeled in accordance to IEC 61076-4-101 and prevailing industry practice from the top down.

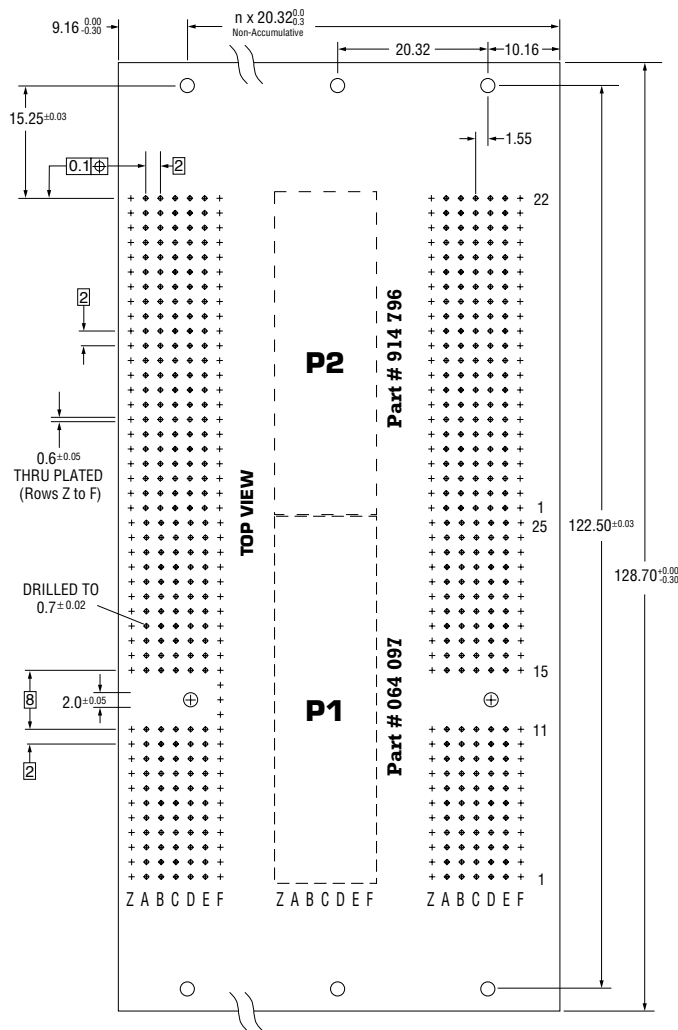

Note that the backplane is numbered in accordance with the CompactPCI® specification. The numbering on the connectors themselves is different and in accordance with the IEC 61076-4-101 standard.

All dimensions are in millimeters (mm) unless otherwise noted.

## 6U CompactPCI® Daughter Card Layout

The 6U CompactPCI® backplane layout is provided to clarify the contact numbering and connector nomenclature used within the specification.

As is typical of some telecommunication applications, the CompactPCI® specification numbers the signals and connectors from the bottom up. Manufacturers and users should note that the connectors themselves are labeled in accordance to IEC 61076-4-101 and prevailing industry

practice from the top down.

In many applications, the J3, J4 and J5 connectors are used for user I/O. The J3 connector matches the VME64 extensions P0 connector exactly and falls symmetrically on the centerline of the daughter card. Designers should note that this connector is not on the same grid as the J1, J2, J4 and J5 connectors.

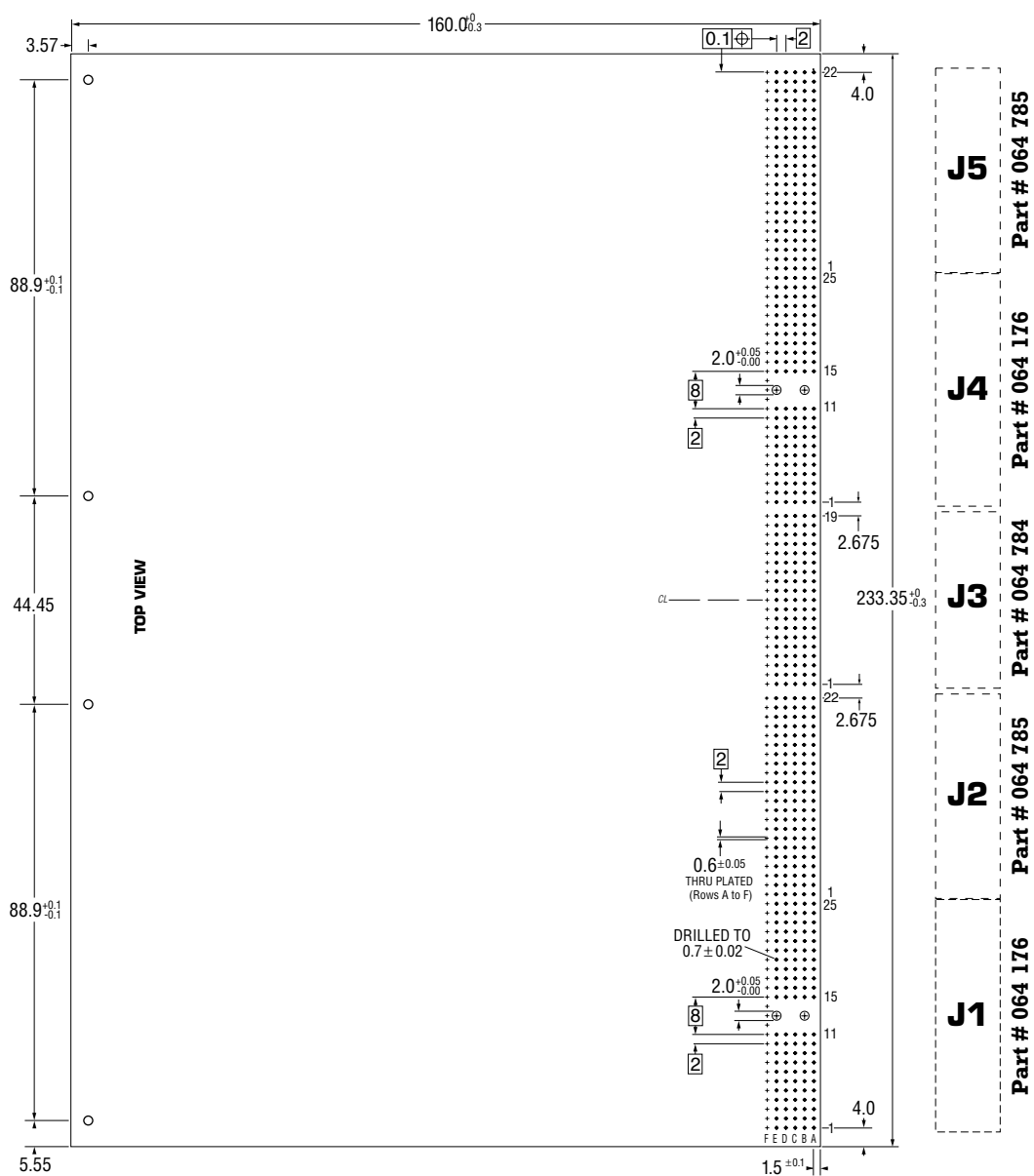

Note that the daughter card is numbered in accordance with the CompactPCI® specification. The numbering on the connectors themselves is different and in accordance with the IEC 61076-4-101 standard.

All dimensions are in millimeters (mm) unless otherwise noted.

## 6U CompactPCI® Backplane Layout

The 6U CompactPCI® backplane layout is provided to clarify the contact numbering and connector nomenclature used within the specification.

As is typical of some telecommunication applications, the CompactPCI® specification numbers the signals and connectors from the bottom up. Manufacturers and users should note that the connectors themselves are labeled in accordance to IEC 61076-4-101 and prevailing industry practice from the top down.

In many applications, the P3, P4 and P5 connectors are designed for user I/O. Therefore connectors with 16 mm rear tails are used with shrouds installed on the rear side. The P3 connector matches the VME64 extensions J0 connector exactly, and falls symmetrically on the centerline of the backplane. Designers should note that this connector is not on the same grid as the P1, P2, P4 and P5 connectors.

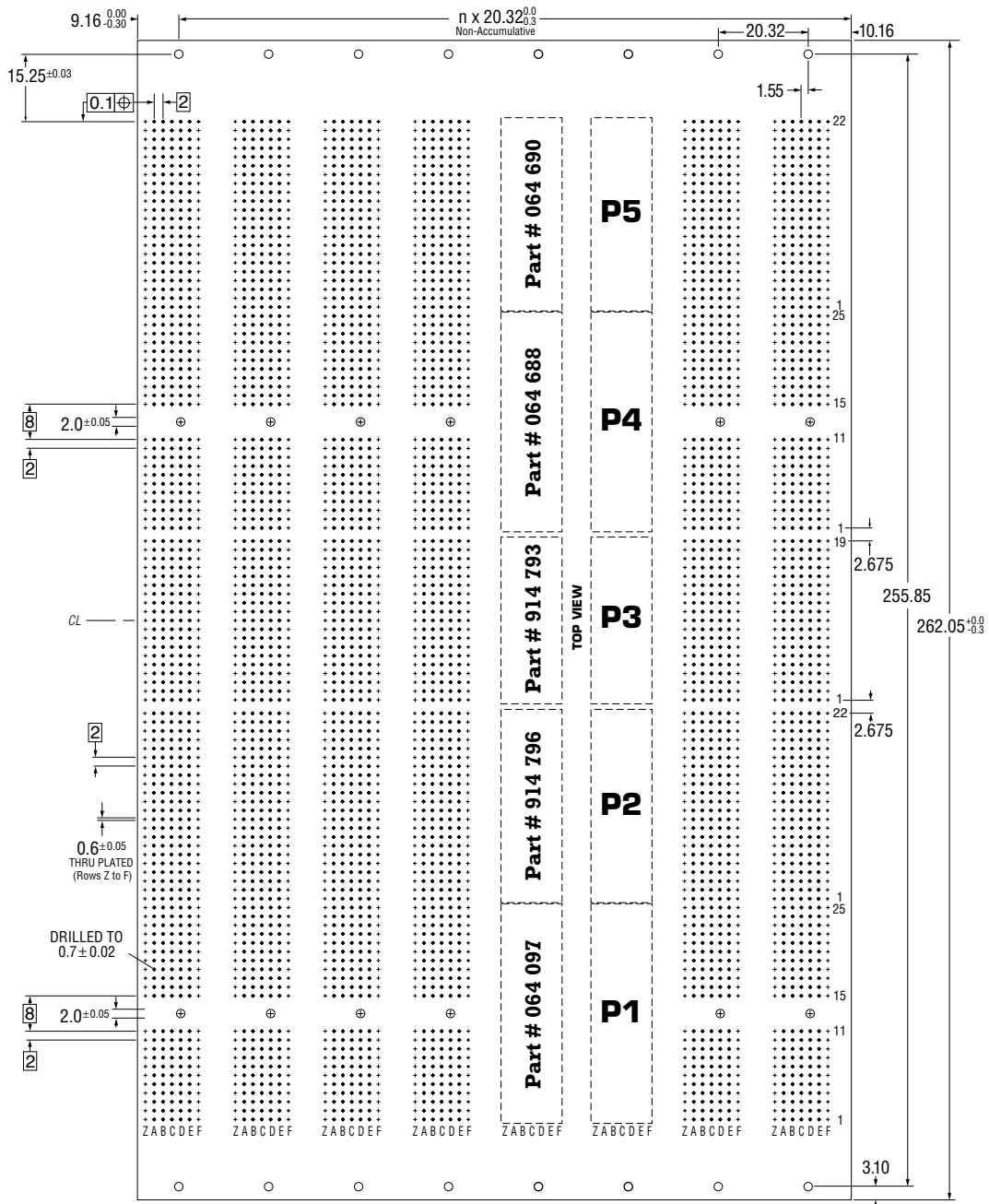

Note that the backplane is numbered in accordance with the CompactPCI® specification. The numbering on the connectors themselves is different and in accordance with the IEC 61076-4-101 standard.

All dimensions are in millimeters (mm) unless otherwise noted.

# 9U 10-Row 2mm Daughter Card Layout

This 9U eurocard compatible daughtercard layout is provided for designers who need over 1400 signal pins in a eurocard format. This is one of the highest I/O densities

that is currently available in a eurocard format. This design is to be used with the ERmet 8+2 row connectors.

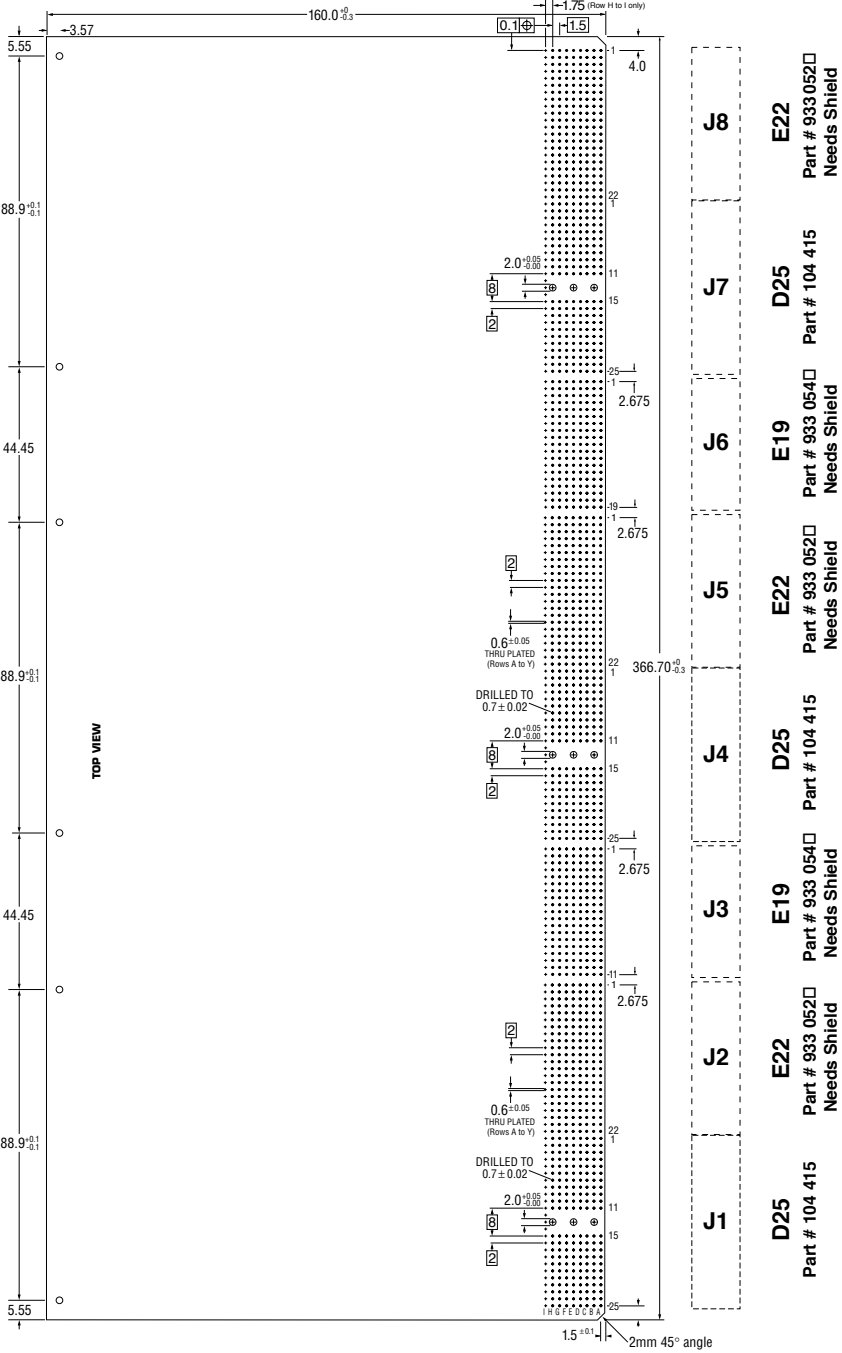

Note that the numbering scheme conforms with the Type V numbering as defined in VITA30-199x Draft 0.5 dated 9 June 1999 and is from the top down. This numbering scheme is identical to the numbering established for the connector within the IEC 61076-4-101 standard.

# 9U 10-Row 2mm Backplane Layout

This 9U eurocard compatible backplane layout is provided for designers who need over 1400 signal pins in a eurocard format. This is one of the highest I/O densities that is currently available in a eurocard format. This design is to be

used with the ERmet 8+2 row connectors. Note that the backplane connectors have a 5HP or 25.4 mm slot to slot spacing.

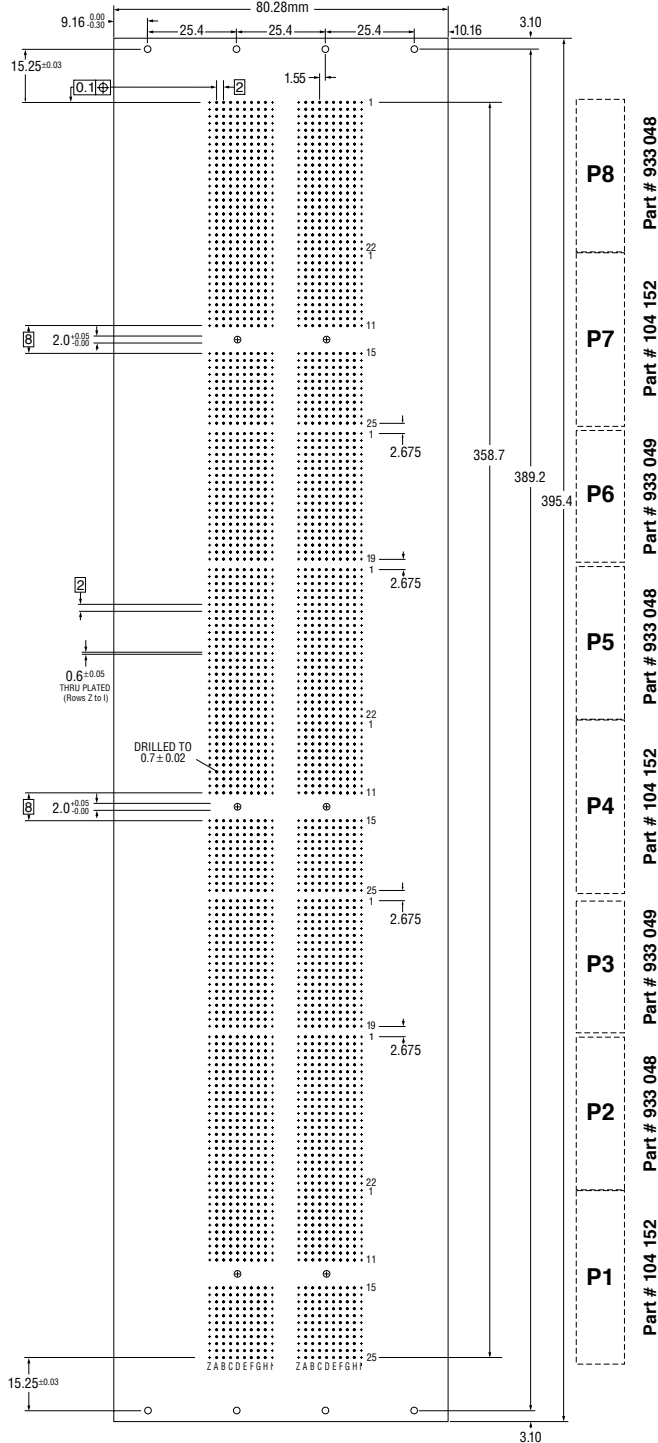

Note that the numbering scheme conforms with the Type V numbering as defined in VITA30-199x Draft 0.5 dated 9 June 1999 and is from the top down. This numbering scheme is identical to the numbering established for the connector within the IEC 61076-4-101 standard.

# IEEE 1301 Daughter Cards for IEC 61076-4-101 2mm HM Connectors

The 2mm HM Connector was originally developed to be used within subrack and backplanes designed in accordance with IEEE 1301 Standard for Metric Equipment Practices for Microcomputers. This was a standard that was popular with the large telecommunication companies. Although IEEE 1301 never became as popular as the IEEE

1101 line of Eurocard Packaging, engineers still may occasionally need to layout daughter cards and backplanes to this standard. Note that this layout is drawn to show both the connector grid for 5+2 row connectors and 8+2 row connectors.

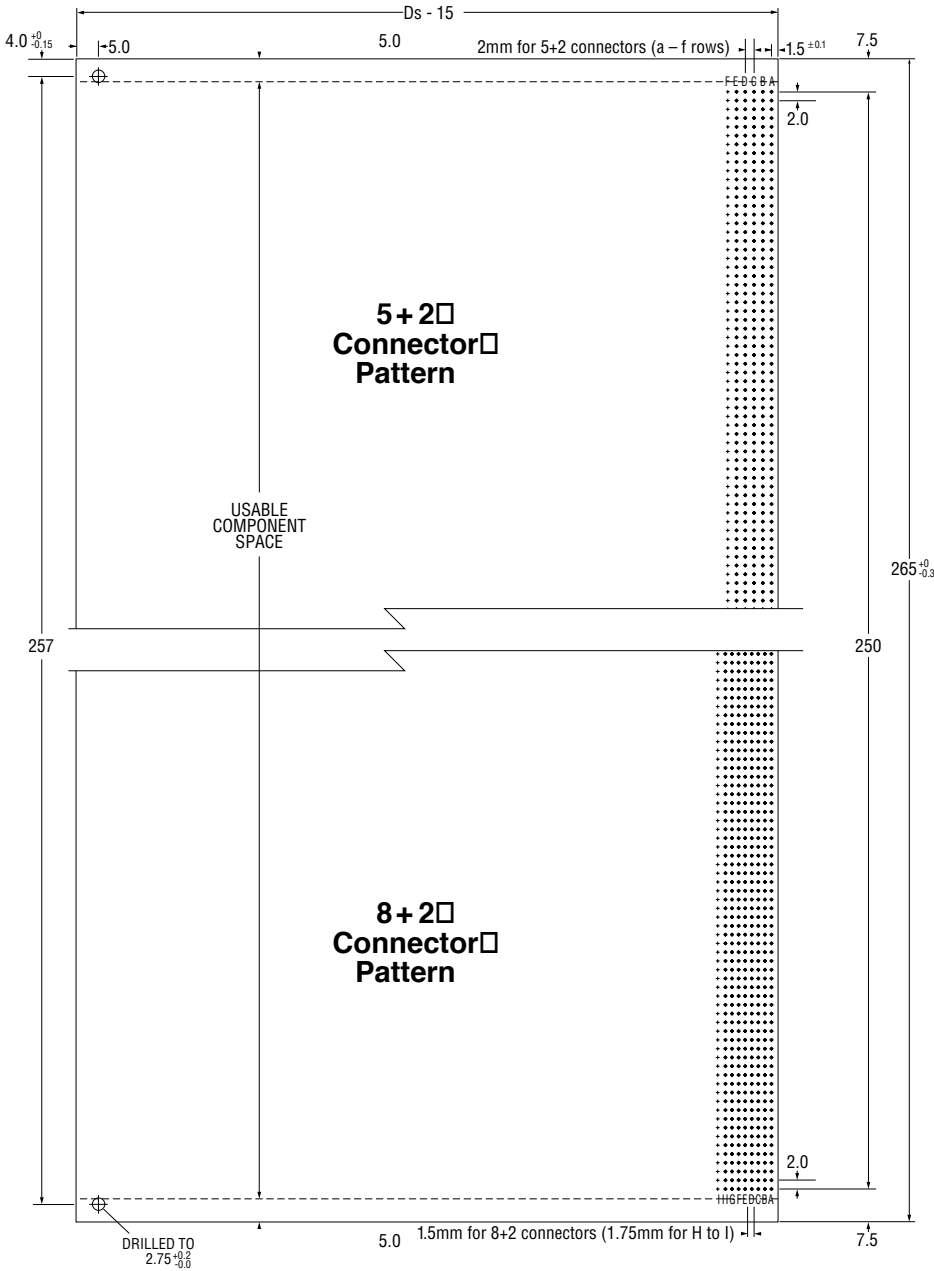

# IEEE 1301 Backplane Layouts For IEC 61076-4-101 2mm HM Connectors

The 2mm HM Connector was originally developed to be used within subrack and backplanes designed in accordance with IEEE 1301 Standard for Metric Equipment Practices for Microcomputers. This was a standard that was popular with the large telecommunication companies. Although IEEE 1301 never became as popular as the IEEE

1101 line of Eurocard Packaging, engineers still may occasionally need to layout daughter cards and backplanes to this standard. Note that this layout is drawn to show both the connector grid for 8+2 connectors and 5+2 row connectors. Although this standard defines multiple heights, this drawing is for the popular 12 SU height.

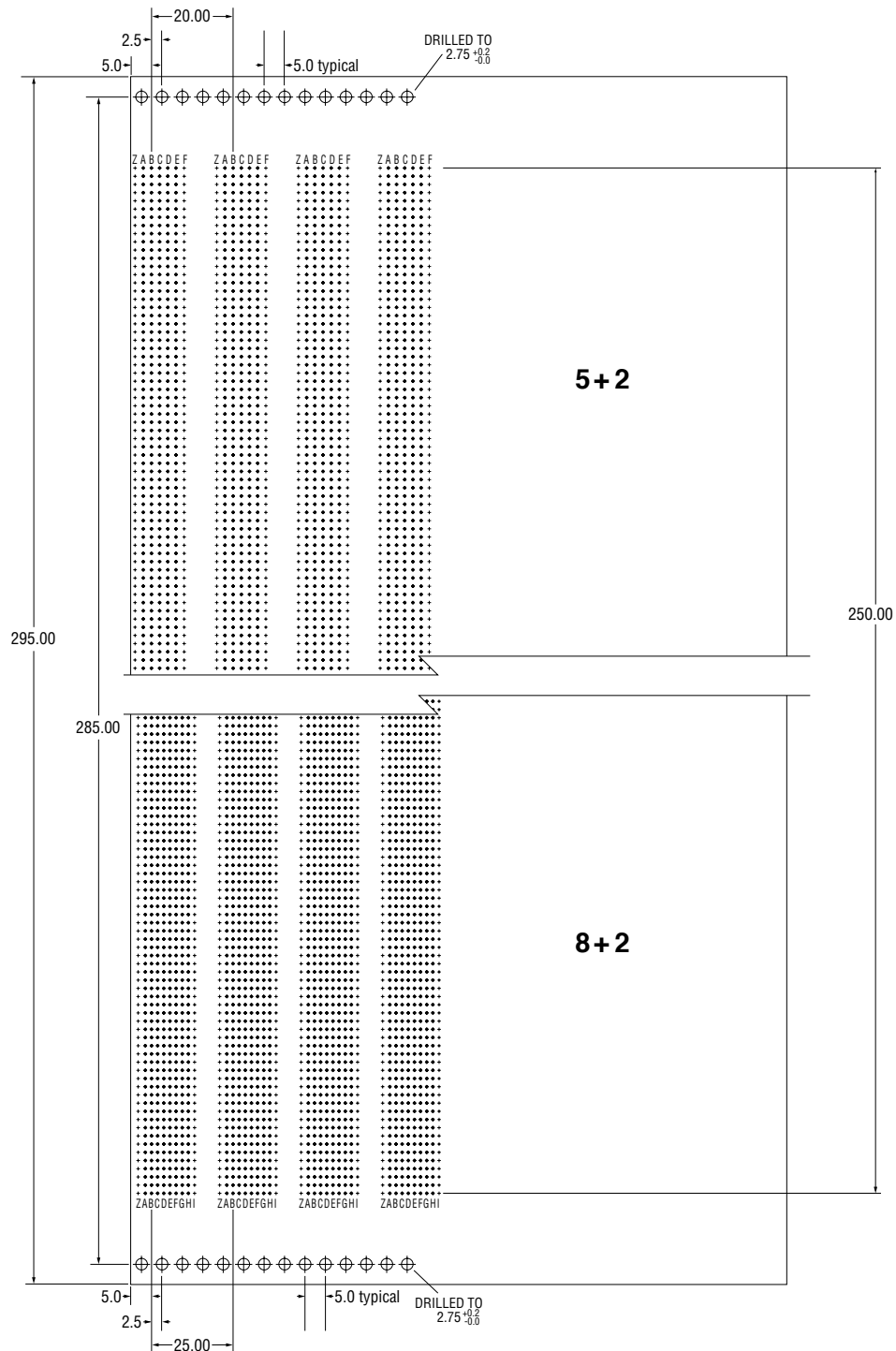



# VME64 Extensions Daughter Card

The 6U VME64 Extensions document, IEEE 1101.10 defines the daughter card locations for a 2mm HM P0 connector. This connector is the same connector defined as the J3 connector defined in the VITA 30 2mm equipment practice and used for CompactPCI daughter cards.

Note that the 2mm HM connector is located symmetrically in between the upper P1 and lower P2 connectors. This connector is mounted 1.5 mm from the rear board edge but the 160 pin VME64x connector is mounted 2.76 mm from the rear board edge.

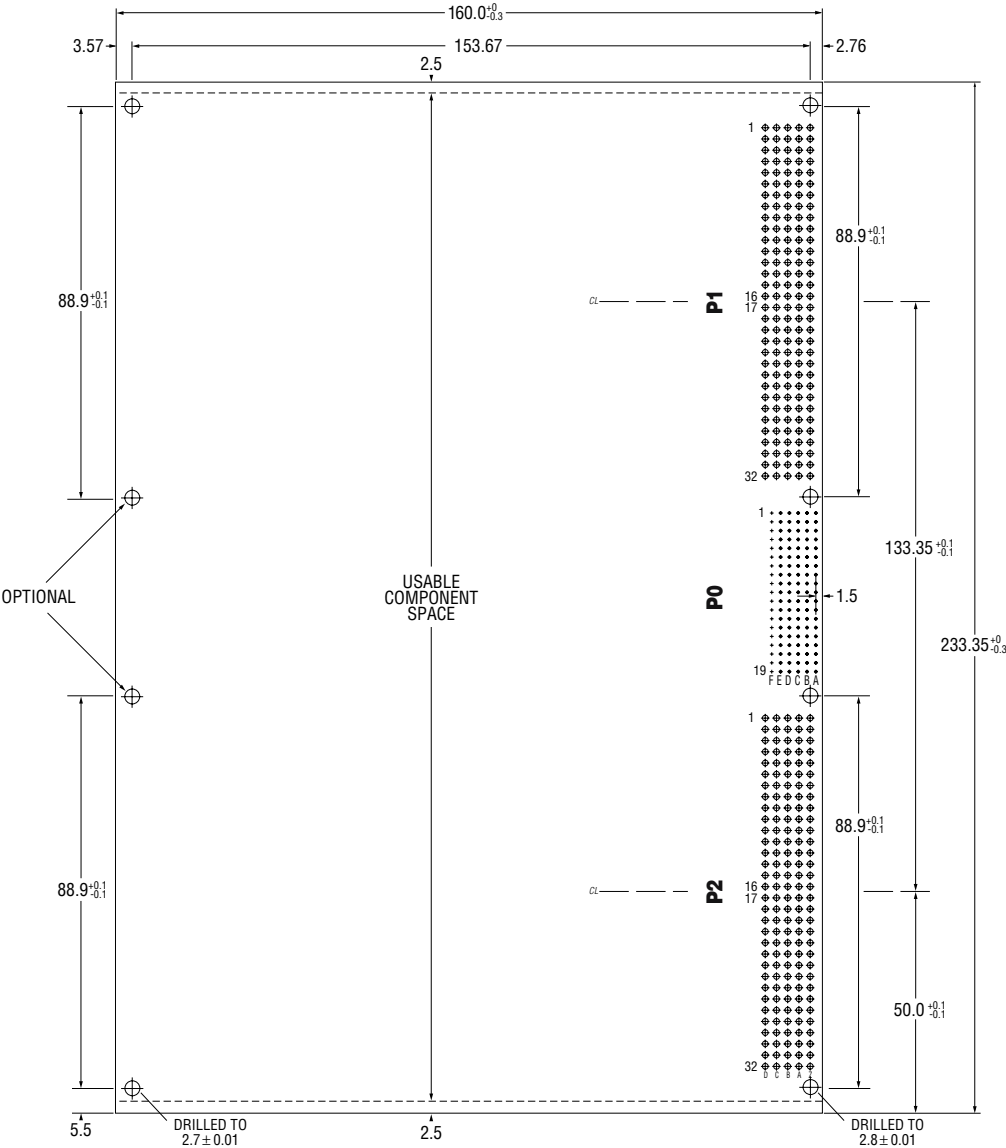

Note that the numbering of the P0 connector conforms to IEEE 1101.1 and 1101.10 and is from the top down. This also is the same numbering scheme established by the connector standard IEC 61076-4-101.

# VME64 Extensions Backplane

The 6U VME64 Extensions backplane layout depicts the nomenclature and numbering conventions used in the IEEE 1101.10 draft standard. The J0 center connector is the same 19 position ERmet 2mm H. M. connector used in CompactPCI®. The design of this connector allows it to mate properly with the J1 and J2 connectors which are in accordance with

DIN 41612. Note that there is a 1.85 mm offset between the "C" row of the J0 connector and the "B" row of the 2.54 mm (.100") J1/J2 connectors. On the daughter card, pin 10 of the P0 connector falls exactly on the board's centerline, and pin "A 1" is placed 1.5 mm from the board's edge.

ERmet 2.0mm

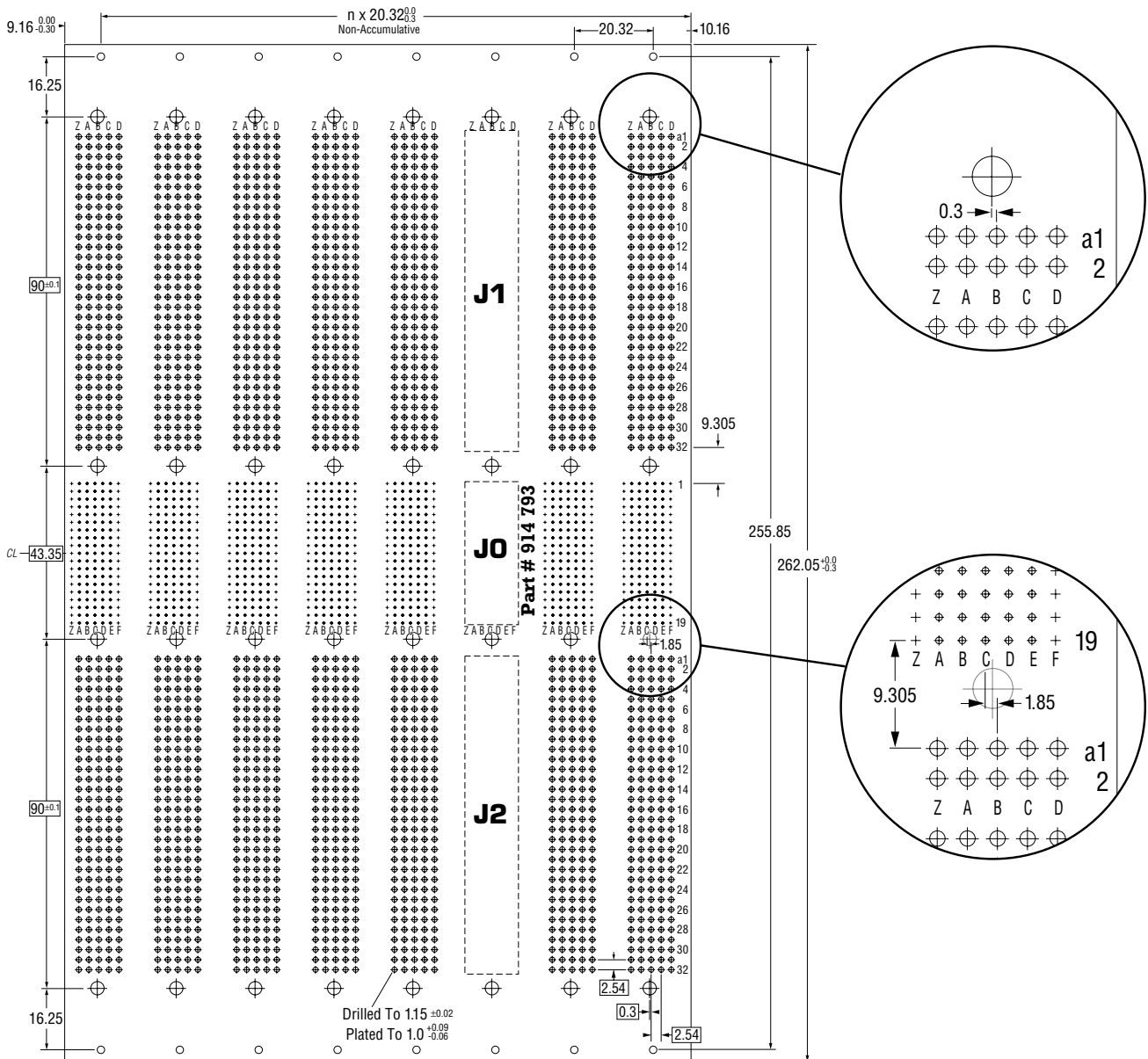

Note that the numbering of the P0 connector conforms to IEEE 1101.1 and 1101.10 and is from the top down. This also is the same numbering scheme established by the connector standard IEC 61076-4-101.

## 64 Bit CompactPCI® System Slot Pin Assignments

In the case of the 64 bit CompactPCI®, both the P1 and P2 connectors are fully assigned with no pins available for user defined I/O. For such systems, only 6U designs can have rear panel I/O.

Although CompactPCI® is designed to be accomplished on 3U cards, 6U implementations provide optional P3, P4 and

P5 connectors, which all have undefined pins for user I/O. 6U CompactPCI® provides more user defined pins than any other bus structure today.

PIN	Z <sup>(10)</sup>	A	B	C	D	E	F		
22	GND	GA4 <sup>(6)</sup>	GA3 <sup>(6)</sup>	GA2 <sup>(6)</sup>	GA1 <sup>(6)</sup>	GA0 <sup>(6)</sup>	GND	<b>P2</b>	
21	GND	CLK6	GND	RSV	RSV	RSV	GND		
20	GND	CLK5	GND	RSV	GND	RSV	GND		
19	GND	GND	GND	RSV <sup>(9)</sup>	RSV <sup>(9)</sup>	RSV <sup>(9)</sup>	GND		
18	GND	BRSVP2A18	BRSVP2B18	BRSVP2C18	GND <sup>(8)</sup>	BRSVP2E18	GND		
17	GND	BRSVP2A17	GND	PRST#	REQ6#	GNT6#	GND		
16	GND	BRSVP2A16	BRSVP2B16	DEG#	GND	BRSVP2E16	GND		
15	GND	BRSVP2A15	GND	FAL#	REQ5#	GNT5#	GND		
14	GND	AD[35]	AD[34]	AD[33]	GND	AD[32]	GND		<b>C O N N E C T O R</b>
13	GND	AD[38]	GND	V(I/O) <sup>(3)</sup>	AD[37]	AD[36]	GND		
12	GND	AD[42]	AD[41]	AD[40]	GND	AD[39]	GND		
11	GND	AD[45]	GND	V(I/O) <sup>(3)</sup>	AD[44]	AD[43]	GND		
10	GND	AD[49]	AD[48]	AD[47]	GND	AD[46]	GND		
9	GND	AD[52]	GND	V(I/O) <sup>(3)</sup>	AD[51]	AD[50]	GND		
8	GND	AD[56]	AD[55]	AD[54]	GND	AD[53]	GND		
7	GND	AD[59]	GND	V(I/O) <sup>(3)</sup>	AD[58]	AD[57]	GND		
6	GND	AD[63]	AD[62]	AD[61]	GND	AD[60]	GND		
5	GND	C/BE[5]#	GND	V(I/O) <sup>(3)</sup>	C/BE[4]#	PAR64	GND		
4	GND	V(I/O) <sup>(3)</sup>	BRSVP2B4	C/BE[7]#	GND	C/BE[6]#	GND		
3 <sup>(3)</sup>	GND	CLK4	GND	GNT3#	REQ4#	GNT4#	GND		
2 <sup>(3)</sup>	GND	CLK2	CLK3	SYSEN# <sup>(4)</sup>	GNT2#	REQ3#	GND		
1 <sup>(3)</sup>	GND	CLK1	GND	REQ1#	GNT1#	REQ2#	GND		
25	GND	5V	REQ64#	ENUM#	3.3V	5V	GND	<b>P1</b>	
24	GND	AD[1]	5V	V(I/O) <sup>(3)(11)</sup>	AD[0]	ACK64#	GND		
23	GND	3.3V	AD[4]	AD[3]	5V <sup>(11)</sup>	AD[2]	GND		
22	GND	AD[7]	GND	3.3V <sup>(11)</sup>	AD[6]	AD[5]	GND		
21	GND	3.3V	AD[9]	AD[8]	M66EN <sup>(5)</sup>	C/BE[0]#	GND		
20	GND	AD[12]	GND	V(I/O) <sup>(3)</sup>	AD[11]	AD[10]	GND		
19	GND	3.3V	AD[15]	AD[14]	GND <sup>(11)</sup>	AD[13]	GND		
18	GND	SERR#	GND	3.3V	PAR	C/BE[1]#	GND		
17	GND	3.3V	IPMB SCL	IPMB SDA	GND <sup>(11)</sup>	PERR#	GND		
16	GND	DEVSEL#	GND	V(I/O) <sup>(1)(3)</sup>	STOP#	LOCK#	GND		
15	GND	3.3V	FRAME#	IRDY#	GND <sup>(2)</sup>	TRDY#	GND		
12-14	KEY AREA								<b>C O N N E C T O R</b>
11	GND	AD[18]	AD[17]	AD[16]	GND <sup>(11)</sup>	C/BE[2]#	GND		
10	GND	AD[21]	GND	3.3V	AD[20]	AD[19]	GND		
9	GND	C/BE[3]#	GND <sup>(3)</sup>	AD[23]	GND <sup>(11)</sup>	AD[22]	GND		
8	GND	AD[26]	GND	V(I/O) <sup>(3)</sup>	AD[25]	AD[24]	GND		
7	GND	AD[30]	AD[29]	AD[28]	GND <sup>(11)</sup>	AD[27]	GND		
6	GND	REQ0#	GND	3.3V <sup>(11)</sup>	CLK0	AD[31]	GND		
5	GND	BRSVP1A5	BRSVP1B5	RST#	GND <sup>(11)</sup>	GNT0#	GND		
4	GND	IPMB PWR	HEALTHY# <sup>(7)</sup>	V(I/O) <sup>(3)(11)</sup>	INTP	INTS	GND		
3	GND	INTA#	INTB#	INTC#	5V <sup>(11)</sup>	INTD#	GND		
2	GND	TCK <sup>(8)</sup>	5V	TMS <sup>(8)</sup>	TDO <sup>(8)</sup>	TDI <sup>(8)</sup>	GND		
1	GND	5V	-12V	TRST# <sup>(8)</sup>	+12V	5V	GND		
PIN	Z <sup>(10)</sup>	A	B	C	D	E	F		

Per CompactPCI® Specification 2.0 R3.0, October 1, 1999, Tabelle 15

- (1) Early mate pins.
- (2) Late mate pins.
- (3) 3.3 V or 5.0 V.
- (4) Grounded in system slot.
- (5) Ground for a 33 MHz backplane. Bussed slot to slot in 66 MHz systems.
- (6) Each slot may have a unique geographic address encoding. See the CompactPCI® specification for details.
- (7) Backplane must leave pin open and provide # bypass capacitor.
- (8) JTAG is being discouraged. These pins will be redefined.
- (9) To be used for I<sup>2</sup>C bus.
- (10) Daughtercards do not make use of "z" row grounds.

Note: Chart numbering conforms to the CompactPCI® specification. Connector numbering is from top to bottom in accordance with the IEC standard.

## 64 Bit CompactPCI® Peripheral Slot Pin Assignments

In the case of the 64 bit CompactPCI®, both the P1 and P2 connectors are fully assigned with no pins available for user defined I/O. For such systems, only 6U designs can have rear panel I/O.

Although CompactPCI® is designed to be accomplished on 3U cards, 6U implementations provide

optional P3, P4 and P5 connectors, which all have undefined pins for user I/O. 6U CompactPCI® provides more user defined pins than any other bus structure today.

PIN	Z <sup>(10)</sup>	A	B	C	D	E	F		
22	GND	GA4 <sup>(6)</sup>	GA3 <sup>(6)</sup>	GA2 <sup>(6)</sup>	GA1 <sup>(6)</sup>	GA0 <sup>(6)</sup>	GND	<b>P2</b>	
21	GND	RSV	RSV	RSV	RSV	RSV	GND		
20	GND	RSV	RSV	RSV	GND	RSV	GND		
19	GND	RSV	RSV	RSV	RSV	RSV	GND		
18	GND	BRSVP2A18	BRSVP2B18	BRSVP2C18	GND	BRSVP2E18	GND		
17	GND	BRSVP2A17	GND	RSV	RSV	RSV	GND		
16	GND	BRSVP2A16	BRSVP2B16	RSV	GND <sup>(8)</sup>	BRSVP2E16	GND		
15	GND	BRSVP2A15	GND	RSV	RSV	RSV	GND		
14	GND	AD[35]	AD[34]	AD[33]	GND	AD[32]	GND		<b>C O N N E C T O R</b>
13	GND	AD[38]	GND	V(I/O) <sup>(3)</sup>	AD[37]	AD[36]	GND		
12	GND	AD[42]	AD[41]	AD[40]	GND	AD[39]	GND		
11	GND	AD[45]	GND	V(I/O) <sup>(3)</sup>	AD[44]	AD[43]	GND		
10	GND	AD[49]	AD[48]	AD[47]	GND	AD[46]	GND		
9	GND	AD[52]	GND	V(I/O) <sup>(3)</sup>	AD[51]	AD[50]	GND		
8	GND	AD[56]	AD[55]	AD[54]	GND	AD[53]	GND		
7	GND	AD[59]	GND	V(I/O) <sup>(3)</sup>	AD[58]	AD[57]	GND		
6	GND	AD[63]	AD[62]	AD[61]	GND	AD[60]	GND		
5	GND	C/BE[5]#	GND	V(I/O) <sup>(3)</sup>	C/BE[4]#	PAR64	GND		
4	GND	V(I/O) <sup>(3)</sup>	BRSVP2B4	C/BE[7]#	GND	C/BE[6]#	GND		
3 <sup>(3)</sup>	GND	RSV	GND	RSV	RSV	RSV	GND		
2 <sup>(3)</sup>	GND	RSV	RSV	UNC <sup>(4)</sup>	RSV	RSV	GND		
1 <sup>(3)</sup>	GND	RSV	GND	RSV	RSV	RSV	GND		
25	GND	5V	REQ64#	ENUM#	3.3V	5V	GND	<b>P1</b>	
24	GND	AD[1]	5V	V(I/O) <sup>(3)(1)</sup>	AD[0]	ACK64#	GND		
23	GND	3.3V	AD[4]	AD[3]	5V <sup>(1)</sup>	AD[2]	GND		
22	GND	AD[7]	GND	3.3V <sup>(1)</sup>	AD[6]	AD[5]	GND		
21	GND	3.3V	AD[9]	AD[8]	M66EN <sup>(4)(5)</sup>	C/BE[0]#	GND		
20	GND	AD[12]	GND	V(I/O) <sup>(3)</sup>	AD[11]	AD[10]	GND		
19	GND	3.3V	AD[15]	AD[14]	GND <sup>(1)</sup>	AD[13]	GND		
18	GND	SERR#	GND	3.3V	PAR	C/BE[1]#	GND		
17	GND	3.3V	IPMBSCL	IPMBSDA	GND <sup>(1)</sup>	PERR#	GND		
16	GND	DEVSEL#	GND	V(I/O) <sup>(3)</sup>	STOP#	LOCK#	GND		
15	GND	3.3V	FRAME#	IRDY#	BD SEL# <sup>(2)</sup>	TRDY#	GND		
12-14	KEY AREA								<b>C O N N E C T O R</b>
11	GND	AD[18]	AD[17]	AD[16]	GND <sup>(1)</sup>	C/BE[2]#	GND		
10	GND	AD[21]	GND	3.3V	AD[20]	AD[19]	GND		
9	GND	C/BE[3]#	IDSEL <sup>(2)</sup>	AD[23]	GND <sup>(1)</sup>	AD[22]	GND		
8	GND	AD[26]	GND	V(I/O) <sup>(3)</sup>	AD[25]	AD[24]	GND		
7	GND	AD[30]	AD[29]	AD[28]	GND <sup>(1)</sup>	AD[27]	GND		
6	GND	REQ#	GND	3.3V <sup>(1)</sup>	CLK	AD[31]	GND		
5	GND	BRSVP1A5	BRSVP1B5	RST#	GND <sup>(1)</sup>	GNT#	GND		
4	GND	IPMB PWR	HEALTHY <sup>(7)</sup>	V(I/O) <sup>(3)(1)</sup>	INTP	INTS	GND		
3	GND	INTA#	INTB#	INTC#	5V <sup>(1)</sup>	INTD#	GND		
2	GND	TCK <sup>(8)</sup>	5V	TMS <sup>(8)</sup>	TDO <sup>(8)</sup>	TDI <sup>(8)</sup>	GND		
1	GND	5V	-12V	TRST# <sup>(8)</sup>	+12V	5V	GND		
PIN	Z <sup>(10)</sup>	A	B	C	D	E	F		

Per CompactPCI® Specification 2.0 R3.0, October 1, 1999, Tabelle 13

- (1) Early mate pins.
- (2) Late mate pins.
- (3) 3.3 V or 5.0 V.
- (4) Grounded in system slot.
- (5) Ground for a 33 MHz backplane. Bussed slot to slot in 66 MHz systems.
- (6) Each slot may have a unique geographic address encoding. See the CompactPCI® specification for details.
- (7) Backplane must leave pin open and provide # bypass capacitor.
- (8) JTAG is being discouraged. These pins will be redefined.
- (9) To be used for I<sup>2</sup>C bus.
- (10) Daughtercards do not make use of "z" row grounds.

Note: Chart numbering conforms to the CompactPCI® specification. Connector numbering is from top to bottom in accordance with the IEC standard.

## 32 Bit CompactPCI® System Slot Pin Assignments

The CompactPCI® specification defines a 32 bit implementation. The 32 bit implementation makes the entire P2/J2 connector (upper) available for user defined I/O for slots 2-8. The controller card slot (usually slot 1) makes use of some P2 pins for such functions as clock, arbitration,

grant/requests and some other system functions.

In many 32 bit systems, the backplane connector in the P2 position will have 16 mm rear tails and a shroud so I/O signals may pass through the backplane to rear mounted cards or cable assemblies.

PIN	Z <sup>(6)</sup>	A	B	C	D	E	F	
22	GND	GA4 <sup>(5)</sup>	GA3 <sup>(5)</sup>	GA2 <sup>(5)</sup>	GA1 <sup>(5)</sup>	GA0 <sup>(5)</sup>	GND	<b>P2</b>
21	GND	CLK6#	GND	BP(I/O)	BP(I/O)	BP(I/O)	GND	
20	GND	CLK5#	GND	BP(I/O)	BP(I/O)	BP(I/O)	GND	
19	GND	GND	GND	BP(I/O) <sup>(9)</sup>	BP(I/O) <sup>(9)</sup>	BP(I/O) <sup>(9)</sup>	GND	
18	GND	BP(I/O)	BP(I/O)	BP(I/O)	BP(I/O)	BP(I/O)	GND	
17	GND	BP(I/O)	BP(I/O)	PRST#	REQ6#	GNT6#	GND	
16	GND	BP(I/O)	BP(I/O)	DEG#	GND	BP(I/O)	GND	
15	GND	BP(I/O)	BP(I/O)	FAL#	REQ5#	GNT5#	GND	
14	GND	BP(I/O)	BP(I/O)	BP(I/O)	BP(I/O)	BP(I/O)	GND	
13	GND	BP(I/O)	BP(I/O)	BP(I/O)	BP(I/O)	BP(I/O)	GND	
12	GND	BP(I/O)	BP(I/O)	BP(I/O)	BP(I/O)	BP(I/O)	GND	
11	GND	BP(I/O)	BP(I/O)	BP(I/O)	BP(I/O)	BP(I/O)	GND	
10	GND	BP(I/O)	BP(I/O)	BP(I/O)	BP(I/O)	BP(I/O)	GND	
9	GND	BP(I/O)	BP(I/O)	BP(I/O)	BP(I/O)	BP(I/O)	GND	
8	GND	BP(I/O)	BP(I/O)	BP(I/O)	BP(I/O)	BP(I/O)	GND	
7	GND	BP(I/O)	BP(I/O)	BP(I/O)	BP(I/O)	BP(I/O)	GND	
6	GND	BP(I/O)	BP(I/O)	BP(I/O)	BP(I/O)	BP(I/O)	GND	
5	GND	BP(I/O)	BP(I/O)	BP(I/O)	BP(I/O)	BP(I/O)	GND	
4	GND	V(I/O)	BP(I/O)	BP(I/O)	BP(I/O)	BP(I/O)	GND	
3	GND	CLK4	GND	GNT3#	REQ4#	GNT4#	GND	
2	GND	CLK2	CLK3	SYSEN# <sup>(10)</sup>	GNT2#	REQ3#	GND	
1	GND	CLK1	GND	REQ1#	GNT1#	REQ2#	GND	
25	GND	5V	REQ64#	ENUM#	3.3V	5V	GND	<b>P1</b>
24	GND	AD[1]	5V	V(I/O) <sup>(3)(1)</sup>	AD[0]	ACK64#	GND	
23	GND	3.3V	AD[4]	AD[3]	5V <sup>(1)</sup>	AD[2]	GND	
22	GND	AD[7]	GND	3.3V <sup>(1)</sup>	AD[6]	AD[5]	GND	
21	GND	3.3V	AD[9]	AD[8]	M66EN <sup>(4)</sup>	C/BE[0]#	GND	
20	GND	AD[12]	GND	V(I/O) <sup>(5)</sup>	AD[11]	AD[10]	GND	
19	GND	3.3V	AD[15]	AD[14]	GND <sup>(1)</sup>	AD[13]	GND	
18	GND	SERR#	GND	3.3V	PAR	C/BE[1]#	GND	
17	GND	3.3V	IPMBSCL	IPMBSDA	GND <sup>(1)</sup>	PERR#	GND	
16	GND	DEVSEL	GND	V(I/O) <sup>(1)(3)</sup>	STOP#	LOCK#	GND	
15	GND	3.3v	FRAME#	IRDY	GND <sup>(2)</sup>	TRDY#	GND	
12-14	KEY AREA							
11	GND	AD[18]	AD[17]	AD[16]	GND <sup>(1)</sup>	C/BE[2]#	GND	
10	GND	AD[21]	GND	3.3V	AD[20]	AD[19]	GND	
9	GND	C/BE[3]#	GND <sup>(2)</sup>	AD[23]	GND <sup>(1)</sup>	AD[22]	GND	
8	GND	AD[26]	GND	V(I/O) <sup>(5)</sup>	AD[25]	AD[24]	GND	
7	GND	AD[30]	AD[29]	AD[28]	GND <sup>(1)</sup>	AD[27]	GND	
6	GND	REQ0#	GND	3.3V <sup>(1)</sup>	CLK	AD[31]	GND	
5	GND	BRSVP1A5	BRSVP1B5	RST#	GND <sup>(1)</sup>	GNT0#	GND	
4	GND	IPMB PWR	HEALTHY# <sup>(7)</sup>	V(I/O) <sup>(3)(1)</sup>	INTP	INTS	GND	
3	GND	INTA#	INTB#	INTC#	5V <sup>(1)</sup>	INTD#	GND	
2	GND	TCK <sup>(8)</sup>	5V	TMS <sup>(8)</sup>	TDO <sup>(8)</sup>	TDI <sup>(8)</sup>	GND	
1	GND	5V	-12V	TRST# <sup>(8)</sup>	+12V	5V	GND	
PIN	Z <sup>(6)</sup>	A	B	C	D	E	F	

Per CompactPCI® Specification 2.0 R3.0, October 1, 1999, Tabelle 16

- (1) Early mate pins.
- (2) Late mate pins.
- (3) 3.3 V or 5.0 V.
- (4) Grounded in 33 MHz backplane. Bussed slot to slot in 66 MHz systems
- (5) Each slot may have a unique geographic address encoding. See the CompactPCI® specification for details.
- (6) Daughter cards do not make use of the "Z" row grounds.
- (7) Backplane must leave pin open and provide # bypass capacitor.
- (8) JTAG is being discouraged. These pins will be redefined.
- (9) To be used for I<sup>2</sup>C bus.
- (10) Grounded in system slot.

Notes: All P2 terminals should be 16 mm long with shroud installed unless they are used for a secondary bus. Chart numbering conforms to the CompactPCI® specification. Connector numbering is from top to bottom in accordance with the IEC standard.

## 32 Bit CompactPCI® Peripheral Slot Pin Assignments

The CompactPCI® specification defines a 32 bit implementation. The 32 bit implementation makes the entire P2/J2 connector (upper) available for user defined I/O for slots 2-8. The controller card slot (usually slot 1) makes use of some P2 pins for such functions as clock, arbitration,

grant/requests and some other system functions. In many 32 bit systems, the backplane connector in the P2 position will have 16 mm rear tails and a shroud so I/O signals may pass through the backplane to rear mounted cards or cable assemblies.

PIN	Z <sup>(6)</sup>	A	B	C	D	E	F		
22	GND	GA4 <sup>(5)</sup>	GA3 <sup>(5)</sup>	GA2 <sup>(5)</sup>	GA1 <sup>(5)</sup>	GA0 <sup>(5)</sup>	GND	<b>P2</b>	
21	GND	BP(I/O)	BP(I/O)	BP(I/O)	BP(I/O)	BP(I/O)	GND		
20	GND	BP(I/O)	BP(I/O)	BP(I/O)	BP(I/O)	BP(I/O)	GND		
19	GND	BP(I/O)	BP(I/O)	BP(I/O)	BP(I/O)	BP(I/O)	GND		
18	GND	BP(I/O)	BP(I/O)	BP(I/O)	BP(I/O)	BP(I/O)	GND		
17	GND	BP(I/O)	BP(I/O)	BP(I/O)	BP(I/O)	BP(I/O)	GND		
16	GND	BP(I/O)	BP(I/O)	BP(I/O)	BP(I/O)	BP(I/O)	GND		
15	GND	BP(I/O)	BP(I/O)	BP(I/O)	BP(I/O)	BP(I/O)	GND		
14	GND	BP(I/O)	BP(I/O)	BP(I/O)	BP(I/O)	BP(I/O)	GND		
13	GND	BP(I/O)	BP(I/O)	BP(I/O)	BP(I/O)	BP(I/O)	GND		
12	GND	BP(I/O)	BP(I/O)	BP(I/O)	BP(I/O)	BP(I/O)	GND		
11	GND	BP(I/O)	BP(I/O)	BP(I/O)	BP(I/O)	BP(I/O)	GND		
10	GND	BP(I/O)	BP(I/O)	BP(I/O)	BP(I/O)	BP(I/O)	GND		
9	GND	BP(I/O)	BP(I/O)	BP(I/O)	BP(I/O)	BP(I/O)	GND		
8	GND	BP(I/O)	BP(I/O)	BP(I/O)	BP(I/O)	BP(I/O)	GND		
7	GND	BP(I/O)	BP(I/O)	BP(I/O)	BP(I/O)	BP(I/O)	GND		
6	GND	BP(I/O)	BP(I/O)	BP(I/O)	BP(I/O)	BP(I/O)	GND		
5	GND	BP(I/O)	BP(I/O)	BP(I/O)	BP(I/O)	BP(I/O)	GND		
4	GND	BP(I/O)	BP(I/O)	BP(I/O)	BP(I/O)	BP(I/O)	GND		
3	GND	BP(I/O)	BP(I/O)	BP(I/O)	BP(I/O)	BP(I/O)	GND		
2	GND	BP(I/O)	BP(I/O)	BP(I/O)	BP(I/O)	BP(I/O)	GND		
1	GND	BP(I/O)	BP(I/O)	BP(I/O)	BP(I/O)	BP(I/O)	GND		
25	GND	5V	REQ64#	ENUM#	3.3V	5V	GND	<b>P1</b>	
24	GND	AD[1]	5V	V(I/O) <sup>(3)(1)</sup>	AD[0]	ACK64#	GND		
23	GND	3.3V	AD[4]	AD[3]	5V <sup>(1)</sup>	AD[2]	GND		
22	GND	AD[7]	GND	3.3V <sup>(1)</sup>	AD[6]	AD[5]	GND		
21	GND	3.3V	AD[9]	AD[8]	M66EN <sup>(4)</sup>	C/BE[0]#	GND		
20	GND	AD[12]	GND	V(I/O) <sup>(3)</sup>	AD[11]	AD[10]	GND		
19	GND	3.3V	AD[15]	AD[14]	GND <sup>(1)</sup>	AD[13]	GND		
18	GND	SERR#	GND	3.3V	PAR	C/BE[1]#	GND		
17	GND	3.3V	IPMBSCS	IPMBSDA	GND <sup>(1)</sup>	PERR#	GND		
16	GND	DEVSEL	GND	V(I/O) <sup>(1)(3)</sup>	STOP#	LOCK#	GND		
15	GND	3.3v	FRAME#	IRDY	BD SEL <sup>(2)</sup>	TRDY#	GND		
12-14		KEY AREA							
11	GND	AD[18]	AD[17]	AD[16]	GND <sup>(1)</sup>	C/BE[2]#	GND		
10	GND	AD[21]	GND	3.3V	AD[20]	AD[19]	GND		
9	GND	C/BE[3]#	IDSEL <sup>(2)</sup>	AD[23]	GND <sup>(1)</sup>	AD[22]	GND		
8	GND	AD[26]	GND	V(I/O) <sup>(3)</sup>	AD[25]	AD[24]	GND		
7	GND	AD[30]	AD[29]	AD[28]	GND <sup>(1)</sup>	AD[27]	GND		
6	GND	REQ#	GND	3.3V <sup>(1)</sup>	CLK	AD[31]	GND		
5	GND	BRSVP1A5	BRSVP1B5	RST#	GND <sup>(1)</sup>	GNT#	GND		
4	GND	IPMB PWR	HEALTHY# <sup>(7)</sup>	V(I/O) <sup>(3)(1)</sup>	INTP	INTS	GND		
3	GND	INTA#	INTB#	INTC#	5V <sup>(1)</sup>	INTD#	GND		
2	GND	TCK <sup>(8)</sup>	5V	TMS <sup>(8)</sup>	TDO <sup>(8)</sup>	TDI <sup>(8)</sup>	GND		
1	GND	5V	-12V	TRST# <sup>(8)</sup>	+12V	5V	GND		
PIN	Z <sup>(6)</sup>	A	B	C	D	E	F		

Per CompactPCI® Specification 2.0 R3.0, October 1, 1999, Tabelle 14

- (1) Early mate pins.
- (2) Late mate pins.
- (3) 3.3 V or 5.0 V.
- (4) Grounded in 33 MHz backplane. Bussed slot to slot in 66 MHz systems
- (5) Each slot may have a unique geographic address encoding. See the CompactPCI® specification for details.
- (6) Daughter cards do not make use of the "Z" row grounds.
- (7) Backplane must leave pin open and provide # bypass capacitor.
- (8) JTAG is being discouraged. These pins will be redefined.

Notes: All P2 terminals should be 16 mm long with shroud installed unless they are used for a secondary bus. Chart numbering conforms to the CompactPCI® specification. Connector numbering is from top to bottom in accordance with the IEC standard.

# cPCI Computer Telephony P4 Pin Assignments

## Mechanical Specifications - Backplane and Chassis

Pos#	Row Z	Row A	Row B	Row C	Row D	Row E	Row F						
25	NP	SGA4	M	SGA3	M	SGA2	M	SGA1	M	SGA0	M	FG	L
24	NP	GA4	M	GA3	M	GA2	M	GA1	M	GA0	M	FG	L
23	NP	+12V	M	/CT_Reset	M	/CT_EN	S	-12v	M	CT_MC	M	FG	L
22	NP	PFS0#	M	RSVD	M	RSVD	M	RSVD	M	RSVD	M	FG	L
21	NP	-SELbat	L	PFS1#	M	RSVD	M	RSVD	M	SELVbatRtn	L	FG	L
20	NP	NP		NP		NP		NP		NP		NP	
19	NP	NP		NP		NP		NP		NP		NP	
18	NP	VRG	M	NP		NP		NP		VRGTN	M	NP	
17	NP	NP		NP		NP		NP		NP		NP	
16	NP	NP		NP		NP		NP		NP		NP	
15	NP	-VBAT	L	NP		NP		NP		VBATRtn	L	NP	
12-14	KEY AREA (keep unobstructed on backplane to ease routing constraints)												
11	NP	CT_D29	M	CT_D30	M	CT_D31	M	V(I/O)	L	/CT_FRAME_A	M	GND	L
10	NP	CT_D27	M	+3.3V	M	CT_D28	M	+5V	L	/CT_FRAME_B	M	GND	L
9	NP	CT_D24	M	CR_D25	M	CT_D26	M	GND	L	/FR_COMP	M	GND	L
8	NP	CT_D21	M	CT_D22	M	CT_D23	M	+5V	L	CT_C8_A	M	GND	L
7	NP	CT_D19	M	+5V	M	CT_D20	M	GND	L	CT_C8_B	M	GND	L
6	NP	CT_D16	M	CT_C17	M	CT_D18	M	GND	L	CT_NETREF_1	M	GND	L
5	NP	CT_D13	M	CT_D14	M	CT_D15	M	+3.3V	L	CT_NETREF_2	M	GND	L
4	NP	CT_D11	M	+5V	M	CT_D12	M	+3.3V	L	SCLK	M	GND	L
3	NP	CT_D8	M	CT_D9	M	CT_D10	M	GND	L	SCLK-D	M	GND	L
2	NP	CT_D4	M	CT_D5	M	CT_D6	M	CT_D7	M	GND	L	GND	L
1	NP	CT_D0	M	+3.3V	M	CTP_D1	M	CT_D2	M	CT_D3	M	GND	L

Per CompactPCI® Specification PICMG 2.5 R1.0, April 3, 1998, Table 1

### Key to P4 Pin Assignments

- Ct\_name = H.110 TDM bus signals
- +5V = +5V power
- +3.3V = +3.3V power
- GND = LOGIC GROUND
- V(I/O) = I/O cell power
- FG = Frame Ground
- RSVD = reserved for future use
- NP = a pin and pad to Not be Populated
- SELVbat = short loop battery
- SELVbatRtn = short loop battery return
- Vbat = telecom power distribution bus
- VbatRtn = return bus pin for -Vbat
- SGA0-SGA4 = shelf enumeration bus signals
- GA0-GA4 = slot ID signals; not bussed
- VRG = bus for ringing voltage
- VRGRtn = bus for ringing voltage
- PFS0#-PFS1# = busses for power fail sense
- KEY AREA = area utilized for key
- S = Short (Level 1) front side pins
- M = Medium (Level 2) front side pins
- L = Long (Level 3) front side pins

## cPCI Computer Telephony Safety Classifications for J4/P4

Pos#	Row Z	Row A	Row B	Row C	Row D	Row E	Row F
25	<b>SELV</b>						
24							
23							
22							
21							
20	NP	NP	NP	NP	NP	NP	NP
19	NP	NP	NP	NP	NP	NP	NP
18	NP	<b>HAZ</b>	IN/C-NP	IN/C-NP	IN/C-NP	<b>HAZ</b>	NP
17	NP	NP	NP	NP	NP	NP	NP
16	NP	NP	NP	NP	NP	NP	NP
15	NP	<b>HAZ</b>	IN/C-NP	IN/C-NP	IN/C-NP	<b>HAZ</b>	NP
14	KEY AREA (keep unobstructed on backplane to ease routing constraints)						
13							
12							
11	<b>SELV</b>						
10							
9							
8							
7							
6	<b>SELV</b>						
5							
4							

Per CompactPCI® Computer Telephony Specification PICMG 2.5 R1.0, April 3, 1998, Table 11



## cPCI Computer Telephony P5 Pin Assignments

Pos#	Row Z		Row A		Row B		Row C		Row D		Row E		Row F	
22	NP-IN/C	U	T1	S	T9	S	T17	S	T25	S	IN/C	S	GND-IN/C	L
21	NP-IN/C	U	R1	S	R9	S	R17	S	R25	S	IN/C	S	GND-IN/C	L
20	NP-IN/C	U	T2	S	T10	S	T18	S	T26	S	IN/C	S	GND-IN/C	L
19	NP-IN/C	U	R2	S	R10	S	R18	S	R26	S	IN/C	S	GND-IN/C	L
18	NP-IN/C	U	T3	S	T11	S	T19	S	T27	S	IN/C	S	GND-IN/C	L
17	NP-IN/C	U	R3	S	R11	S	R19	S	R27	S	IN/C	S	GND-IN/C	L
16	NP-IN/C	U	T4	S	T12	S	T20	S	T28	S	IN/C	S	GND-IN/C	L
15	NP-IN/C	U	R4	S	R12	S	R20	S	R28	S	IN/C	S	GND-IN/C	L
13	NP-IN/C	U	R5	S	R13	S	R21	S	R29	S	IN/C	S	GND-IN/C	L
12	NP-IN/C	U	T6	S	T14	S	T22	S	T30	S	IN/C	S	GND-IN/C	L
11	NP-IN/C	U	R6	S	R14	S	R22	S	R30	S	IN/C	S	GND-IN/C	L
10	NP-IN/C	U	T7	S	T15	S	T23	S	T31	S	IN/C	S	GND-IN/C	L
9	NP-IN/C	U	R7	S	R15	S	R23	S	R31	S	IN/C	S	GND-IN/C	L
8	NP-IN/C	U	T8	S	T16	S	T24	S	T32	S	IN/C	S	GND-IN/C	L
7	NP-IN/C	U	R8	S	R16	S	R24	S	R32	S	IN/C	S	GND-IN/C	L
6	NP-IN/C	U	IN/C	S	IN/C	S	IN/C	S	IN/C	S	IN/C	S	GND-IN/C	L
5	NP-IN/C	U	IN/C	S	IN/C	S	IN/C	S	IN/C	S	IN/C	S	GND-IN/C	L
4	NP-IN/C	U	Uo0	M	Uo1	M	GND_Ft	M	GND_Ft	M	GND_Ft	M	GND-IN/C	L
3	NP-IN/C	U	Ui0	M	Ui1	M	Uo4	M	Uo5	M	Uo6	M	GND-IN/C	L
2	NP-IN/C	U	Uo2	M	Uo3	M	Ui4	M	Ui5	M	Ui6	M	GND-IN/C	L
1	NP-IN/C	U	Ui2	M	Ui3	M	+5V_FT	M	+12V_FT	M	-12V_FT	M	GND-IN/C	L

Per CompactPCI® Computer Telephony Specification PICMG 2.5 R1.0, April 3, 1998, Table 3

### Key to P5 Pin Assignments

<i>Tn</i>	= Tip
<i>Rn</i>	= Ring
IN/C	= No Connect required for safety agency Insulation requirements
NP	= a position required to be Not Populated (i.e., no conductive element present)
NP-IN/C	= a position which may be either Not Populated or Insulation No Connect
GND-IN/C	= a position which may be either LOGIC GROUND or Insulation No Connect
+ <i>nV_FT</i>	= positive supply voltage feed-through from CT Front Card
- <i>nV_FT</i>	= negative supply voltage feed-through from CT Front Card
GND_FT	= logic ground feed-through from CT Front Card
<i>Uin</i>	= Universal Input - user defined input signal (input to CT Front Card)
<i>Uon</i>	= Universal Output - user defined input signal (output to CT Front Card)
U	= a pin of unspecified length

S	= Short (Level 1) front side pins
M	= Medium (Level 2) front side pins
L	= Long (Level 3) front side pins

### 2.3.2.1. P5 Telephony I/O Pins

*Tn* - Tip - short (Level 1) pins for connecting to the nominally positive side of a balanced pair telephony connection

*Rn* - Ring - short (Level 1) pins for connecting to the nominally negative side of a balanced pair telephony connection

## cPCI Computer Telephony Safety Classifications for J5/P5

Pos#	Row Z	Row A	Row B	Row C	Row D	Row E	Row F				
22	NP-IN/C	<b>TNV3-SELV</b>				<b>TNV1-SELV</b>	S	IN/C	<b>SELV</b>	L	
21	NP-IN/C						S	IN/C		L	
20	NP-IN/C						S	IN/C		L	
19	NP-IN/C						S	IN/C		L	
18	NP-IN/C						S	IN/C		L	
17	NP-IN/C						S	IN/C		L	
16	NP-IN/C						S	IN/C		L	
15	NP-IN/C						S	IN/C		L	
14	NP-IN/C						S	IN/C		L	
13	NP-IN/C						S	IN/C		L	
12	NP-IN/C						S	IN/C		L	
11	NP-IN/C						S	IN/C		L	
10	NP-IN/C						S	IN/C		L	
9	NP-IN/C						S	IN/C		L	
8	NP-IN/C	S	IN/C	L							
7	NP-IN/C	S	IN/C	L							
6	NP-IN/C	IN/C	IN/C	IN/C	IN/C	S	IN/C	L			
5	NP-IN/C	IN/C	IN/C	IN/C	IN/C	S	IN/C	L			
4	NP-IN/C	<b>SELV</b>							L		
3	NP-IN/C										L
2	NP-IN/C										L
1	NP-IN/C										L

Per CompactPCI® Computer Telephony Specification PICMG 2.5 R1.0, April 3, 1998, Table 12

## PXI Generic Peripheral Slot Pinout

PIN	Row F	Row E	Row D	Row C	Row B	Row A	PMC Slot		
22	GND	<b>PXI_RSVA22</b>	<b>PXI_RSVB22</b>	<b>PXI_RSVC22</b>	<b>PXI_RSVD22</b>	<b>PXI_RSVE22</b>	GND	<b>P2/J2</b>	
21	GND	<b>PXI_LBR0</b>	GND	<b>PXI_LBR1</b>	<b>PXI_LBR2</b>	<b>PXI_LBR3</b>	GND		
20	GND	<b>PXI_LBL4</b>	<b>PXI_LBR5</b>	<b>PXI_LBL0</b>	GND	<b>PXI_LBL1</b>	GND		
19	GND	<b>PXI_LBL2</b>	GND	<b>PXI_LBL3</b>	<b>PXI_LBL4</b>	<b>PXI_LBL5</b>	GND		
18	GND	<b>PXI_TRIG3</b>	<b>PXI_TRIG4</b>	<b>PXI_TRIG5</b>	GND	<b>PXI_TRIG6</b>	GND		
17	GND	<b>PXI_TRIG2</b>	GND	<b>PRST#</b>	<b>PXI_STAR</b>	<b>PXI_CLK10</b>	GND		
16	GND	<b>PXI_TRIG1</b>	<b>PXI_TRIG0</b>	DEG#	GND	<b>PXI_TRIG7</b>	GND		
15	GND	<b>PXI_BRSVA15</b>	GND	FAL#	<b>PXI_LBL6</b>	<b>PXI-LBR6</b>	GND		
14	GND	AD[35]	AD[34]	AD[33]	GND	AD[32]	GND		
13	GND	AD[38]	GND	V[I/0]	AD[37]	AD[36]	GND		
12	GND	AD[42]	AD[41]	AD[40]	GND	AD[39]	GND		
11	GND	AD[45]	GND	V[I/0]	AD[44]	AD[43]	GND		
10	GND	AD[49]	AD[48]	AD[47]	GND	AD[46]	GND		
9	GND	AD[52]	GND	V[I/0]	AD[51]	AD[50]	GND		
8	GND	AD[56]	AD[55]	AD[54]	GND	AD[53]	GND		
7	GND	AD[59]	GND	V[I/0]	AD[58]	AD[57]	GND		
6	GND	AD[63]	AD[62]	AD[61]	GND	AD[60]	GND		
5	GND	C/BE[5]#	GND	V[I/0]	C/BE[4]#	PAR64	GND		
4	GND	V[I/0]	<b>PXI_BRSVB4</b>	C/BE[7]#	GND	C/BE[6]#	GND		
3	GND	<b>PXI_LBR7</b>	GND	<b>PXI_LBR8</b>	<b>PXI_LBR9</b>	<b>PXI_LBR10</b>	GND		
2	GND	<b>PXI_LBR11</b>	<b>PXI_LBR12</b>	SYSEN#	<b>PXI_LBL7</b>	<b>PXI_LBL8</b>	GND		
1	GND	<b>PXI_LBL9</b>	GND	PXI_LBL10	<b>PXI_LBL11</b>	<b>PXI_LBL12</b>	GND		
25	GND	5V	REQ64#	ENUM#	3.3V	5V	GND	<b>P1/J1</b>	
24	GND	AD[1]	5V	V[I/0]	AD[0]	ACK64#	GND		
23	GND	3.3V	AD[4]	AD93]	5V	AD[2]	GND		
22	GND	AD[7]	GND	3.3V	AD[6]	AD[5]	GND		
21	GND	3.3V	AD[9]	AD[8]	M66EN	C/BE[0]#	GND		
20	GND	AD[12]	GND	V[I/0]	AD[11]	AD[10]	GND		
19	GND	3.3V	AD[15]	AD[14]	GND	AD[13]	GND		
18	GND	SERR#	GND	3.3V	PAR	C/BE[1]#	GND		
17	GND	3.3V	SDONE	SBO#	GND	PERR#	GND		
16	GND	DEVSEL#	GND	V[I/0]	STOP#	LOCK#	GND		
15	GND	3.3V	FRAME#	IRDY	GND	TRDY#	GND		
12-14	GND	Key Area							
11	GND	AD[8]	AD[17]	AD[16]	GND	C/BE[2]#	GND		
10	GND	AD[21]	GND	3.3V	AD[20]	AD[19]	GND		
9	GND	C/BE[3]#	IDSEL	AD[23]	GND	AD[22]	GND		
8	GND	AD[26]	GND	V[I/0]	AD[25]	AD[24]	GND		
7	GND	AD[30]	AD[29]	AD[28]	GND	AD[27]	GND		
6	GND	REQ#	GND	3.3V	CLK	AD[31]	GND		
5	GND	BRSVP1A5	BRSVP1B5	RST#	GND	GNT#	GND		
4	GND	BRSVP1A4	GND	V[I/0]	INTP	INTS	GND		
3	GND	INTA#	INTB#	INTC#	5V	INTD#	GND		
2	GND	TCK	5V	TMS	TDO	TDI	GND		
1	GND	5V	-12V	TRST#	+12V	5V	GND		
PIN	Row F	Row E	Row D	Row C	Row B	Row A	PMC Slot		

Per PXI Specification R1.0 August 20, 1997, Table 4.9  
 Signals in Bold are PXI specific

## PXI System Slot Pinout

PIN	Z	A	B	C	D	E	F		
22	GND	<b>PXI_RSVA22</b>	<b>PXI_RSVB22</b>	<b>PXI_RSVC22</b>	<b>PXI_RSVD22</b>	<b>PXI_RSVE22</b>	GND	P2/J2  C O N N E C T O R	
21	GND	CLK6	GND	RSV	RSV	RSV	GND		
20	GND	CLK5	GND	RSV	GND	RSV	GND		
19	GND	GND	GND	RSV	RSV	RSV	GND		
18	GND	<b>PXI_TRIG3</b>	<b>PXI_TRIG4</b>	<b>PXI_TRIG5</b>	GND	<b>PXI_TRIG6</b>	GND		
17	GND	<b>PXI_TRIG2</b>	GND	PRST#	REQ6#	GNT6#	GND		
16	GND	<b>PXI_TRIG1</b>	<b>PXI_TRIG0</b>	DEG#	GND	<b>PXI_TRIG7</b>	GND		
15	GND	<b>PXI_BRSVA15</b>	GND	FAL#	REQ5#	GBT5#	GND		
14	GND	AD[35]	AD[34]	AD[33]	GND	AD[32]	GND		
13	GND	AD[38]	GND	V[I/O]	AD[37]	AD[36]	GND		
12	GND	AD[42]	AD[41]	AD[40]	GND	AD[39]	GND		
11	GND	AD[45]	GND	V[I/O]	AD[44]	AD[43]	GND		
10	GND	AD[49]	AD[48]	AD[47]	GND	AD[46]	GND		
9	GND	AD[52]	GND	V[I/O]	AD[51]	AD[50]	GND		
8	GND	AD[56]	AD[55]	AD[54]	GND	AD[53]	GND		
7	GND	AD[59]	GND	V[I/O]	AD[58]	AD[57]	GND		
6	GND	AD[63]	AD[62]	AD[61]	GND	AD[60]	GND		
5	GND	C/BE[5]#	GND	V[I/O]	C/BE[4]#	PAR64	GND		
4	GND	V[I/O]	<b>PXI_BRSVB4</b>	C/BE[7]#	GND	C/BE[6]#	GND		
3	GND	CLK4	GND	GNT3#	REQ4#	GNT4#	GND		
2	GND	CLK2	CLK3	SYSEN#	GNT2#	REQ3#	GND		
1	GND	CLK1	GND	REQ1#	GNT1#	REQ2#	GND		
25	GND	5V	REQ64#	ENUM#	3.3V	5V	GND		P1/J1  C O N N E C T O R
24	GND	AD[1]	5V	V[1/O]	AD[0]	ACK64#	GND		
23	GND	3.3V	AD[4]	AD[3]	5V	AD[2]	GND		
22	GND	AD[7]	GND	3.3V	AD[6]	AD[5]	GND		
21	GND	3.3V	AD[9]	AD[8]	M66EN	C/BE[0]#	GND		
20	GND	AD[12]	GND	V[I/O]	AD[11]	AD[10]	GND		
19	GND	3.3V	AD[15]	AD[14]	GND	AD[13]	GND		
18	GND	SERR#	GND	3.3V	PAR	C/BE[1]	GND		
17	GND	3.3V	SDONE	SBO#	GND	PERR#	GND		
16	GND	DEVSEL#	GND	V[I/O]	STOP#	LOCK#	GND		
15	GND	3.3V	FRAME#	IRDY#	GND	TRDY#	GND		
12-14	Key Area								
11	GND	AD[18]	AD[17]	AD[16]	GND	C/BE[2]#	GND		
10	GND	AD[21]	GND	3.3V	AD[20]	AD[19]	GND		
9	GND	C/BE[3]#	IDSEL	AD[23]	GND	AD[22]	GND		
8	GND	AD[26]	GND	V[I/O]	AD[25]	AD[24]	GND		
7	GND	AD[30]	AD[29]	AD[28]	GND	AD [27]	GND		
6	GND	REQ#	GND	3.3V	CLK	AD [31]	GND		
5	GND	BRSVP1A5	BRSVP1B5	RST#	GND	GNT#	GND		
4	GND	BRSVP1A4	GND	V[I/O]	INTP	INTS	GND		
3	GND	INTA#	INTB#	INTC#	5V	INTD#	GND		
2	GND	TCK	5V	TMS	TDO	TDI	GND		
1	GND	5V	-12V	TRST#	+12V	5V	GND		
PIN	Z	A	B	C	D	E	F		

Per PXI Specification R1.0 August 20, 1997, Table 4.10  
 Signals in Bold are PXI specific

## PXI Star Trigger Slot Pinout

PIN	Z	A	B	C	D	E	F		
22	GND	<b>PXI_RSVA22</b>	<b>PXI_RSVB22</b>	<b>PXI_RSVC22</b>	<b>PXI_RSVD22</b>	<b>PXI_RSVE22</b>	GND	P2/J2  C O N N E C T O R	
21	GND	<b>PXI_LBR0</b>	GND	<b>PXI_LBR1</b>	<b>PXI_LBR2</b>	<b>PXI_LBR3</b>	GND		
20	GND	<b>PXI_LBR4</b>	<b>PXI_LBR5</b>	<b>PXI_STAR0</b>	GND	<b>PXI_STAR1</b>	GND		
19	GND	<b>PXI_STAR2</b>	GND	<b>PXI_STAR3</b>	<b>PXI_STAR4</b>	<b>PXI_STAR5</b>	GND		
18	GND	<b>PXI_TRIG3</b>	<b>PXI_TRIG4</b>	<b>PXI_TRIG5</b>	GND	<b>PXI_TRIG6</b>	GND		
17	GND	<b>PXI_TRIG2</b>	GND	PRST#	<b>PXI_CLK10_IN</b>	<b>PXI_CLK10</b>	GND		
16	GND	<b>PXI_TRIG1</b>	<b>PXI_TRIG0</b>	DEG#	GND	<b>PXI_TRIG7</b>	GND		
15	GND	<b>PXI_BRSVA15</b>	GND	FAL#	<b>PXI_STAR6</b>	<b>PXILBR6</b>	GND		
14	GND	AD[35]	AD[34]	AD[33]	GND	AD[32]	GND		
13	GND	AD[38]	GND	V[I/0]	AD[37]	AD[36]	GND		
12	GND	AD[42]	AD[41]	AD[40]	GND	AD[39]	GND		
11	GND	AD[45]	GND	V[I/0]	AD[44]	AD[43]	GND		
10	GND	AD[49]	AD[48]	AD[47]	GND	AD[46]	GND		
9	GND	AD[52]	GND	V[I/0]	AD[51]	AD[50]	GND		
8	GND	AD[56]	AD[55]	AD[54]	GND	AD[53]	GND		
7	GND	AD[59]	GND	V[I/0]	AD[58]	AD[57]	GND		
6	GND	AD[63]	AD[62]	AD[61]	GND	AD[60]	GND		
5	GND	C/BE[5]#	GND	V[I/0]	C/BE[4]#	PAR64	GND		
4	GND	V[I/0]	<b>PXI_BRSVB4</b>	C/BE[7]#	GND	C/BE[6]#	GND		
3	GND	<b>PXI_LBR7</b>	GND	<b>PXI_LBR8</b>	<b>PXI_LBR9</b>	<b>PXI_LBR10</b>	GND		
2	GND	<b>PXI_LBR11</b>	<b>PXI_LBR12</b>	SYSEN#	<b>PXI_STAR7</b>	<b>PXI_STAR8</b>	GND		
1	GND	<b>PXI_STAR9</b>	GND	<b>PXI_STAR10</b>	<b>PXI_STAR11</b>	<b>PXI_STAR12</b>	GND		
25	GND	5V	REQ64#	ENUM#	3.3V	5V	GND		P1/J1  C O N N E C T O R
24	GND	AD[1]	5V	V[I/0]	AD[0]	ACK64#	GND		
23	GND	3.3V	AD[4]	AD[3]	5V	AD[2]	GND		
22	GND	AD[7]	GND	3.3V	AD[6]	AD[5]	GND		
21	GND	3.3V	AD[9]	AD[8]	M66#N	C/BE[0]#	GND		
20	GND	AD[12]	GND	V[I/0]	AD[11]	AD[10]	GND		
19	GND	3.3V	AD[15]	AD[14]	GND	AD[13]	GND		
18	GND	SERR#	GND	3.3V	PAR	C/BE[1]#	GND		
17	GND	3.3V	SDONE	SBO#	GND	PERR#	GND		
16	GND	DEVSEL#	GND	V[I/0]	STOP#	LOCK#	GND		
15	GND	3.3V	FRAME#	IRDY#	GND	TRDY#	GND		
12-14		Key Area							
11	GND	AD[18]	AD[17]	AD[16]	GND	C/BE[2]#	GND		
10	GND	AD[21]	GND	3.3V	AD[20]	AD[19]	GND		
9	GND	C/BE[3]#	IDSEL	AD[23]	GND	AD[22]	GND		
8	GND	AD[26]	GND	V[I/0]	AD[25]	AD[24]	GND		
7	GND	AD[30]	AD[29]	AD[28]	GND	AD[27]	GND		
6	GND	REQ#	GND	3.3V	CLK	AD[31]	GND		
5	GND	BRSVP1A5	BRSVP1B5	RST#	GND	GNT#	GND		
4	GND	BRSVP1A4	GND	V[I/0]	INTP	INTS	GND		
3	GND	INTA#	INTB#	INTC#	5V	INTD#	GND		
2	GND	TCK	5V	TMS	TDO	TDI	GND		
1	GND	5V	-12V	TRST#	+12V	5V	GND		
<b>PIN</b>	<b>Z</b>	<b>A</b>	<b>B</b>	<b>C</b>	<b>D</b>	<b>E</b>	<b>F</b>		

Per PXI Specification R1.0 August 20, 1997, Table 4.11  
Signals in Bold are PXI specific

## VME64x on CompactPCI® J4/P4 and J5/P5 Pin Assignments

PIN	A	B	C	D	E	F	
22	ResU(1)	+3.3V	D00	D08	D01	GND	P5/J5 C O N N E C T O R
21	ResU(1)	ACFAIL*	+3.3V	D09	D02	GND	
20	GND	SYSCLK	D10	+3.3V	BERR*	GND	
19	MPR	+3.3V	D03	D11	D04	GND	
18	MCLK	SYSFAIL	+3.3V	D12	D05	GND	
17	GND	SYSRST*	D13	+3.3V	RTRY1*	GND	
16	MSD	+3.3V	D06	D14	D07	GND	
15	MMD	AM5	+3.3V	D15	LWORD*	GND	
14	GND	WRITE*	A23	+3.3V	DS1*	GND	
13	MCTL	+3.3V	A22	A21	A20	GND	
12	BCLR*	AMO	+V1	A19	A18	GND	
11	GND	AMI	A17	+V2	DS0*	GND	
10	BBSY*	+3.3V	A16	A15	A07	GND	
9	BGOIN*	AM2	-V1	A14	A06	GND	
8	GND	AM3	A13	-V2	DTACK*	GND	
7	BGOOUT*	GAP*	A05	A12	A04	GND	
6	BG1IN*	AM4	GA0*	A11	A03	GND	
5	GND	ResB[z13] <sup>(2)</sup>	A10	GA1*	AS*	GND	
4	BG1OUT*	GA2*	A02	A09	A01	GND	
3	BG2IN*	RsvB[z15]	GA3*	A08	A24	GND	
2	GND	RsvB[z17]	A25	GA4*	RETRY*	GND	
1	BG2OUT*	+5V	A26	A27	A28	GND	
25	BG3IN*	RsvB[z19]	+5V	A29	A30	GND	
24	GND	RsvB[z21]	A31	+5V	RsvB[d19]	GND	
23	BG3OUT*	+5V	D16	D17	D18	GND	
22	BR0*	RsvB[z23]	+5V	D19	D20	GND	
21	GND	RsvB[z25]	D21	+5V	RsvB[d21]	GND	
20	BR1*	+5V	D22	D23	D24	GND	
19	BR2*	SERA	+5V	D25	D26	GND	
18	GND	SERB	D27	+12V	RsvB[d23]	GND	
17	BR3*	-12V	D28	D29	D30	GND	
16	LI/*(1)	SBB	VPC(2)	D31	ResB[d25] <sup>(2)</sup>	GND	
15	LI/0*(1)	SBA	ResU(1)	GND(3)	ResB[z27] <sup>(2)</sup>	GND	
12-14	Key Area						P4/J4 C O N N E C T O R
11	IACK*	IACKIN*	IACKOUT*	IRQ7*	IRQ6*	GND	
10	IRQ5*	IRQ4*	IRQ3*	IRQ2*	IRQ1*	GND	
9	GND	GND	GND	GND	GND	GND	
8	UD	UD	UD	UD	UD	GND	
7	UD	UD	UD	UD	UD	GND	
6	UD	UD	UD	UD	UD	GND	
5	UD	UD	UD	UD	UD	GND	
4	UD	UD	UD	UD	UD	GND	
3	UD	UD	UD	UD	UD	GND	
2	UD	UD	UD	UD	UD	GND	
1	UD	UD	UD	UD	UD	GND	
PIN	A	B	C	D	E	F	

Per PICMG 2.2 R1.0 August 7, 1998, Table 1

**Notes:**

(1) These signals are not bused (feed through the backplane).

(2) ResB is the ResBus (reserved bused) signal pins

Connector Key is Reseda Green (ERNI P/N 043346 male, 043336 female)

## PMC Mezzanine Card I/O Pin Assignments

### Single PMC's I/O Signal Mapping to CompactPCI® 3U J2 Connector

PIN	Row F	Row E	Row D	Row C	Row B	Row A	J2 C O N N E C T O R
22	GND	UD	UD	UD	UD	UD	
21	GND	UD	UD	UD	UD	UD	
20	GND	UD	UD	UD	UD	UD	
19	GND	UD	UD	UD	UD	UD	
18	GND	UD	UD	UD	UD	UD	
17	GND	UD	UD	UD	UD	UD	
16	GND	UD	UD	UD	UD	UD	
15	GND	UD	UD	UD	UD	UD	
14	GND	+5V	+5V	+3.3V	+3.3V	+3.3V	
13	GND	1	2	3	4	5	
12	GND	6	7	8	9	10	
11	GND	11	12	13	14	15	
10	GND	16	17	18	19	20	
9	GND	21	22	23	24	25	
8	GND	26	27	28	29	30	
7	GND	31	32	33	34	35	
6	GND	36	37	38	39	40	
5	GND	41	42	43	44	45	
4	GND	46	47	48	49	50	
3	GND	51	52	53	54	55	
2	GND	56	57	58	59	60	
1	GND	61	62	63	64	VI/O	
PIN	Row F	Row E	Row D	Row C	Row B	Row A	

Per PICMG 2.3 R1.0 August 7, 1998, Table 1

**Notes:** 1. Entries in table are of the PMC Jn4 pin number.

2. UD are the remaining user defined I/O pins that can be used for other I/O functions.

### Dual PMC Slot's I/O Signal Mapping to CompactPCI® 6U J3/P3 & J4/P4 Connectors

PIN	Row F	Row E	Row D	Row C	Row B	Row A	PMC Slot	J4 C O N N E C T O R
9	GND	GND	GND	GND	GND	GND		
8	GND	1	2	3	4	5	A	
7	GND	6	7	8	9	10	A	
6	GND	11	12	13	14	15	A	
5	GND	16	17	18	19	20	A	
4	GND	21	22	23	24	25	A	
3	GND	26	27	28	29	30	A	
2	GND	31	32	33	34	35	A	
1	GND	36	37	38	39	40	A	
19	GND	41	42	43	44	45	A	
18	GND	46	47	48	49	50	A	
17	GND	51	52	53	54	55	A	
16	GND	56	57	58	59	60	A	
15	GND	61	62	63	64	VI/O	A	
14	GND	+5V	+5V	+3.3V	+3.3V	+3.3V	A&B	
13	GND	1	2	3	4	5	B	
12	GND	6	7	8	9	10	B	
11	GND	11	12	13	14	15	B	
10	GND	16	17	18	19	20	B	
9	GND	21	22	23	24	25	B	
8	GND	26	27	28	29	30	B	
7	GND	31	32	33	34	35	B	
6	GND	36	37	38	39	40	B	
5	GND	41	42	43	44	45	B	
4	GND	46	47	48	49	50	B	
3	GND	51	52	53	54	55	B	
2	GND	56	57	58	59	60	B	
1	GND	61	62	63	64	VI/O	B	
PIN	Row F	Row E	Row D	Row C	Row B	Row A	PMC Slot	J3 C O N N E C T O R

Per PICMG 2.3 R1.0 August 7, 1998, Table 2

**Notes:** 1. Entries in table are of the PMC Jn4 pin number.

## PMC Mezzanine Card I/O Pin Assignments

### Single PMC Slot's I/O Signal Mapping to CompactPCI® J5/P5 Connector

PIN	Row F	Row E	Row D	Row C	Row B	Row A	J5 C O N N E C T O R
22	GND	1	2	3	4	5	
21	GND	6	7	8	9	10	
20	GND	11	12	13	14	15	
19	GND	16	17	18	19	20	
18	GND	21	22	23	24	25	
17	GND	16	17	18	19	30	
16	GND	31	32	33	34	35	
15	GND	36	37	38	39	40	
14	GND	41	42	43	44	45	
13	GND	46	47	48	49	50	
12	GND	51	52	53	54	55	
11	GND	1	2	3	4	5	
10	GND	6	7	8	9	10	
9	GND	11	12	13	14	15	
8	GND	16	17	18	19	20	
7	GND	21	22	23	24	25	
6	GND	26	27	28	29	30	
5	GND	31	32	33	34	35	
4	GND	36	37	38	39	40	
3	GND	41	42	43	44	45	
2	GND	46	47	48	49	50	
1	GND	51	52	53	54	55	
PIN	Row F	Row E	Row D	Row C	Row B	Row A	

Per PICMG 2.3 R1.0 August 7, 1998, Table 3

**Notes:** 1. Entries in table are of the PMC Jn4 pin number.

2. UD are the remaining user defined I/O pins that can be used for other I/O functions.

### Dual PMC Slot's I/O Signal Mapping to CompactPCI® J5/P5 Connector

PIN	Row F	Row E	Row D	Row C	Row B	Row A	PMC Slot	J5 C O N N E C T O R
22	GND	1	2	3	4	5	A	
21	GND	6	7	8	9	10	A	
20	GND	11	12	13	14	15	A	
19	GND	16	17	18	19	20	A	
18	GND	21	22	23	24	25	A	
17	GND	16	17	18	19	30	A	
16	GND	31	32	33	34	35	A	
15	GND	36	37	38	39	40	A	
14	GND	41	42	43	44	45	A	
13	GND	46	47	48	49	50	A	
12	GND	51	52	53	54	55	A	
11	GND	1	2	3	4	5	B	
10	GND	6	7	8	9	10	B	
9	GND	11	12	13	14	15	B	
8	GND	16	17	18	19	20	B	
7	GND	21	22	23	24	25	B	
6	GND	26	27	28	29	30	B	
5	GND	31	32	33	34	35	B	
4	GND	36	37	38	39	40	B	
3	GND	41	42	43	44	45	B	
2	GND	46	47	48	49	50	B	
1	GND	51	52	53	54	55	B	
PIN	Row F	Row E	Row D	Row C	Row B	Row A	PMC Slot	

Per PICMG 2.3 R1.0 August 7, 1998, Table 4

**Notes:**

1. Entries in table are of the PMC Jn4 pin number.



## IP Mezzanine Module I/O Pin Assignments

### I/O Signal Mapping to CompactPCI® J2 Connector

PIN	Row F	Row E	Row D	Row C	Row B	Row A	IP Module	J2 C O N N E C T O R
22	GND	B5	B4	B3	B2	B1	IP-B	
21	GND	B10	B9	B8	B7	B6	IP-B	
20	GND	B15	B14	B13	B12	B11	IP-B	
19	GND	B20	B19	B18	B17	B16	IP-B	
18	GND	B25	B24	B23	B22	B21	IP-B	
17	GND	B30	B29	B28	B27	B26	IP-B	
16	GND	B35	B34	B33	B32	B31	IP-B	
15	GND	B40	B39	B38	B37	B36	IP-B	
14	GND	B45	B44	B43	B42	B41	IP-B	
13	GND	B50	B49	B48	B47	B46	IP-B	
12	GND	+5V	+5V	+3.3V	+3.3V	+3.3V		
11	GND	A5	A4	A3	A2	A1	IP-A	
10	GND	A10	A9	A8	A7	A6	IP-A	
9	GND	A15	A14	A13	A12	A11	IP-A	
8	GND	A20	A19	A18	A17	A16	IP-A	
7	GND	A25	A24	A23	A22	A21	IP-A	
6	GND	A30	A29	A28	A27	A26	IP-A	
5	GND	A35	A34	A33	A32	A31	IP-A	
4	GND	A40	A39	A38	A37	A36	IP-A	
3	GND	A45	A44	A43	A42	A41	IP-A	
2	GND	A50	A49	A48	A47	A46	IP-A	
1	GND	+5V	+5V	+3.3V	+3.3V	+3.3V		
PIN	Row F	Row E	Row D	Row C	Row B	Row A	IP Module	

Per PICMG 2.4 R1.0 August 7, 1998, Table 1

## IP Mezzanine Module I/O Pin Assignments

### I/O Signal Mapping to CompactPCI® J5 and J4 Connector

PIN	Row F	Row E	Row D	Row C	Row B	Row A	IP Module		
22	GND	D5	D4	D3	D2	D1	IP-D	<b>J5 C O N N E C T O R</b>	
21	GND	D10	D9	D8	D7	D6	IP-D		
20	GND	D15	D14	D13	D12	D11	IP-D		
19	GND	D20	D19	D18	D17	D16	IP-D		
18	GND	D25	D24	D23	D22	D21	IP-D		
17	GND	D30	D29	D28	D27	D26	IP-D		
16	GND	D35	D34	D33	D32	D31	IP-D		
15	GND	D40	D39	D38	D37	D36	IP-D		
14	GND	D45	D44	D43	D42	D41	IP-D		
13	GND	D50	D49	D48	D47	D46	IP-D		
12	GND	+5V	+5V	+3.3V	+3.3V	+3.3V			
11	GND	C5	C4	C3	C2	C1	IP-C		
10	GND	C10	C9	C8	C7	C6	IP-C		
9	GND	C15	C14	C13	C12	C11	IP-C		
8	GND	C20	C19	C18	C17	C16	IP-C		
7	GND	C25	C24	C23	C22	C21	IP-C		
6	GND	C30	C29	C28	C27	C26	IP-C		
5	GND	C35	C34	C33	C32	C31	IP-C		
4	GND	C40	C39	C38	C37	C36	IP-C		
3	GND	C45	C44	C43	C42	C41	IP-C		
2	GND	C50	C49	C48	C47	C46	IP-C		
1	GND	+5V	+5V	+3.3V	+3.3V	+3.3V			
25	GND	B5	B4	B3	B2	B1	IP-B	<b>J4 C O N N E C T O R</b>	
24	GND	B10	B9	B8	B7	B6	IP-B		
23	GND	B15	B14	B13	B12	B11	IP-B		
22	GND	B20	B19	B18	B17	B16	IP-B		
21	GND	B25	B24	B23	B22	B21	IP-B		
20	GND	B30	B29	B28	B27	B26	IP-B		
19	GND	B35	B34	B33	B32	B31	IP-B		
18	GND	B40	B39	B38	B37	B36	IP-B		
17	GND	B45	B44	B43	B42	B41	IP-B		
16	GND	B50	B49	B48	B47	B46	IP-B		
15	GND	+5V	+5V	+3.3V	+3.3V	+3.3V			
12 – 14	Key Area								
11	GND	A5	A4	A3	A2	A1	IP-A		
10	GND	A10	A9	A8	A7	A6	IP-A		
9	GND	A15	A14	A13	A12	A11	IP-A		
8	GND	A20	A19	A18	A17	A16	IP-A		
7	GND	A25	A24	A23	A22	A21	IP-A		
8	GND	A20	A19	A18	A17	A16	IP-A		
7	GND	A25	A24	A23	A22	A21	IP-A		
6	GND	A30	A29	A28	A27	A26	IP-A		
5	GND	A35	A34	A33	A32	A31	IP-A		
4	GND	A40	A39	A38	A37	A36	IP-A		
3	GND	A45	A44	A43	A42	A41	IP-A		
2	GND	A50	A49	A48	A47	A46	IP-A		
1	GND	+5V	+5V	+3.3V	+3.3V	+3.3V			
PIN	Row F	Row E	Row D	Row C	Row B	Row A	IP Module		

Per PICMG 2.4 R1.0 August 7, 1998, Table 2

## Bellcore Lubrication

For some telecom applications particularly those being sold to the various regional telephone companies, lubricated contacts are specified. There are many different ways of meeting this end customer requirement. ERNI will provide pre-lubricated male connectors upon request. There is an additional charge and a special part number for such connectors. It is also possible to apply the Bellcore lubricant to the male backplane connectors after the backplanes have been assembled. This process has the advantage that the

lubricant is not as likely to be damaged or removed by subsequent handling as it is when the connectors are lubricated before assembly. Many end users do not require that lubrication be applied to the female receptacles as the lubricant is easily transferred to the female contacts after mating with a lubricated male contact. Lubricating the male contacts is a practical solution as it is quite difficult for an end customer to inspect the female connector contacts because they are hidden within the insulator.

## BELLCORE Requirements Summary In accordance with Bellcore GR-1217

	CENTRAL OFFICE	UNCONTROLLED ENVIRONMENT
Prequalification Tests for Quality Level II, Level III	Shocks and Vibration - 24 hr., 18 shocks Temperature Life - 500 hr., 85°C Humidity and Temp Cycle - 25°C – 65°C MFG TEST - 10 days, less gas concentration	Shocks and Vibration - 24 hr., 18 shocks Temperature Life - 1,000 hr., 105°C Humidity and Temp Cycle - 5°C – 85°C MFG TEST - 20 days, more gas concentration
<b>Level I</b>	<ul style="list-style-type: none"> <li>• Commercial Grade</li> <li>• Vendor Qualification Process</li> </ul>	<ul style="list-style-type: none"> <li>• Commercial Grade</li> <li>• Vendor Qualification Process</li> </ul>
<b>Level II</b>	Level I with: <ul style="list-style-type: none"> <li>• <b>Tested for less than 1 in 1,000 failures over 10 year life</b></li> <li>• Monitor parametric attributes</li> <li>• Approved by OEM</li> <li>• Ship to stock allowed</li> <li>• Requalify every 5 years</li> </ul>	Level I with: <ul style="list-style-type: none"> <li>• <b>Tested for less than 1 in 1,000 failures over 10 year life</b></li> <li>• Monitor parametric attributes</li> <li>• Approved by OEM</li> <li>• Ship to stock allowed</li> <li>• Requalify every 5 years</li> </ul>
<b>Level III</b>	Level II with: <ul style="list-style-type: none"> <li>• <b>Tested for less than 1 in 10,000 failures over 25 year life</b></li> <li>• Monitor parametric attributes</li> <li>• Ship to stock allowed, provided that connector manufacturer's data are reviewed on lot-on-lot basis</li> <li>• Requalify every 3 years</li> </ul>	Level II with: <ul style="list-style-type: none"> <li>• <b>Tested for less than 1 in 10,000 failures over 25 year life</b></li> <li>• Monitor parametric attributes</li> <li>• Ship to stock allowed, provided that connector manufacturer's data are reviewed on lot-on-lot basis</li> <li>• Requalify every 3 years</li> </ul>

## Glossary Of Terminology

**Annular Ring** – The circular area around a hole that is measured by the difference between the radius of the wall of the hole, subtracted from the radius of the clearance or pad around the hole.

**ANSI** – Abbreviation for American National Standards Institute.

**Artwork** – The representation of the electrical layout of a printed circuit on a transparency.

**Attenuation** – When a signal travels along the bus, its amplitude decreases due to energy losses from heating, radiation, and so forth.

**AWG** – Abbreviation for American Wire Gage. A particular series of specified diameters and thicknesses established as a standard in the U.S.A. and used for nonferrous sheets, rods and wires.

**Backplane** – (1) A wiring board usually constructed as a printed circuit, used in micro and mini computers to provide the required connections between logic, memory and I/O modules. (2) A two-sided or multilayer printed circuit board into which function cards can be plugged. The backplane transfers signals between the function cards. Mounted on the component side of the backplane are connectors into which function cards can be plugged.

On the solder side of the backplane are termination points (studs, power bugs, quick disconnects) for the distribution of power and ground.

**Bellcore** – Bell Research Corporation, originally the research division for AT&T.

**Bus** – A circuit over which data or power is transmitted.

**Bus Structure** – A set of rules governing the circuit design of a system such as: CompactPCI®, VME, Multibus I, Multibus II and Q-Bus, to name a few.

**Characteristic Impedance** – Impedance is referred to as  $Z_0$ , in ohms. It is the resistance seen by a digital signal and is measured between the signal line and the reference plane. This impedance is a function of the signal line geometry and is independent of the line length. Impedance is the key parameter which interrelates all performance characteristics of the backplane, including delay, noise and distributed capacitance.

**CompactPCI®** – A bus structure developed by the PICMG based on the desktop PCI architecture.

**Compliant** – A pin whose physical structure is designed to elastically deform upon insertion into a hole.

**Component Side** – The side of a printed wiring board or backplane into which connectors, resistors, capacitors and so forth are inserted.

**Component Density** – The ratio of the number of components to a given area of a board.

**Conductor Width** – The width of a given trace.

**Conductor Spacing** – The distance between adjacent traces on a printed wiring board.

**Crosstalk** – (1) The interaction observed due to electromagnetic coupling of adjacent conductors. (2) A false signal picked up by a signal line (in an inductive manner) from an adjacent signal line.

**Current** – The net transfer of electric charge, per unit time, along a conductor. An amount equal to the voltage/resistance and measured in Amperes.

**Data Bus** – A bus structure used specifically to transmit data, or bits of information.

**Date Code** – Stamped or printed on a component the week and year the component was made (i.e. 9023 is the 23rd week of the year 1990, or June 3rd-7th, 1990).

**Daughter Card** – Same as function card or function board.

**Decommitted** – To physically remove material from an area of a board so as to break the electrical connection to that plane.

**Decouple** – To prevent transfer or feedback of energy from one circuit to another.

**Dielectric** – (1) A material which is an electrical insulator that can sustain an electrical field with minimum power loss. (2) Any insulating medium that intervenes between two conductors.

**Dielectric Constant** – The property of a material that governs the propagation delay of a signal it surrounds, denoted by  $\epsilon_r$ .

**DIN** – (1) Stands for Deutsches Institut für Normung, a German organization which established many mechanical specifications for connectors and packaging. (2) Vernacular for Standard European connector having 96 pins arranged in 3 rows of 32 pins each. The rows are labeled A, B, C.

**DIP** – Abbreviation for Dual-In-line Package. A device that has two rows or parallel pins. Usually the pins in each row are on .100" centers.

**Discrete Resistor** – An individual resistor, as opposed to a resistor network.

**Distributed Capacitance** – Distributed capacitance, referred to as  $C_0$ , is the amount of capacitance per unit length of a signal line.

**ECL** – Abbreviation for Emitter-Coupled-Logic, a form of current-mode logic in which the emitters of two transistors are connected to a current carrying resistor in such a way that only one will turn on at time.

**ECTF** – The Enterprise Computer Telephony Forum is a trade association that has developed a number of specifications related to computer telephony. Their web address is: <http://www.ectf.org>.

**EIA** – Electronics Industry Association.

## Glossary Of Terminology (continued)

**EMI** – Electromagnetic interference.

**Etch** – To incise an area of a printed wiring board by immersing the board in an acid batch. The parts of the board not covered with an acid-resistant coating will be eroded.

**ERNIPRESS** – The particular compliant section design utilized by ERNI for many DIN 41612 and D-Sub pressfit contacts. This coined, elastic section provides a very reliable gas tight connection with the plated through hole in the backplane or daughter card.

**Eye of the Needle** – This is the compliant section design utilized by ERNI for our 2 mm ERmet pressfit contacts. This pierced and coined elastic section provides a very reliable gas tight connection with the plated through hole in the backplane or daughter card.

**Function Card** – A printed circuit board that plugs into a slot position of a backplane. Function cards can be custom designed by the user or bought as a standard off-the-shelf item. A series of these cards can make up a system or sub-system to run machinery or many other electronic functions.

**GND** – An abbreviation for ground. The potential referred to as zero volts. An electrical connection between any circuit and the reference potential.

**Ground Guard** – The pair of traces which surround a third conductor to minimize crosstalk.

**Ground Plane** – A common conductive surface that receives and returns power/signal transmissions.

**Ground Shield** – A conductor (usually a plane), at some reference potential (e.g. zero volts), which surrounds some other insulated conductor.

**IEC 61076-4-101** – Global specification that governs 2mm Hard Metric equipment practices.

**IEC 917 (DIN 43355)** – Defines a basic pitch of 0.5 mm, with  $n \times 0.5$  mm as the multiple pitch, and a system unit of 25 mm. This, in turn, relates to Hard Metric Equipment practices, IEE 1301 and DIN 43356, used for mechanical arrangement of electrical/electronic equipment, including associated board layout and connections.

**I/O** – Abbreviation for input/output.

**IEEE** – Abbreviation for the Institute of Electronic and Electrical Engineers.

**Impedance** – Resistance of a signal line measured in ohms. One of the important electrical characteristics of a backplane, impedance is determined by the physical dimensions of trace width, dielectric thickness, dielectric constant, and so forth.

**Inductance** – The ratio of the voltage to the rate of change of current in a circuit ( $V/\Delta I$ ).

**Layer** – A plane in a printed wiring board which has a copper covering in some specified pattern (e.g. plane, traces and pads).

**Microstrip** – (1) The name given to a signal line referenced above a single ground plane. (2) The outer etched portion of a backplane transmission line.

**Output** – The current, voltage, power, or signal which a circuit or device delivers.

Terminals where a device delivers its information.

**Pad** – The circular area that commits a hole to an uncommitted layer or trace.

**PCMCIA** – (Personal Computer Memory Card International Association). A standard for removable cards.

**PICMG** – The PCI Industrial Computer Manufacturer's Group is a trade association that has developed a number of specifications related to personal computer architectures and CompactPCI. Their web address is <http://www.picmg.org>.

**Pin-out** – A term used to describe the actual connections for each pin of a connector on a printed wiring board.

**Plated through-hole** – A hole in a printed wiring board, used to commit external or internal layers to one another produced by electro deposition of a conductive pattern.

**Plating** – To form a thin, adherent layer of material (usually metal) on an object.

**PMC** – PCI mezzanine card interface, defined by IEEE 1386

**Pressfit** – An interference connection used in the assembly process to eliminate the need for solder to make the electrical connection.

**Propagation Delay** – (1) Referred to as tpd, commonly expressed in nanoseconds per inch (ns/in.). It is the time required for a pulse to travel through a transmission line system. (2) The time it takes for a signal to spread or distribute across an entire circuit.

**Rack** – (See Subrack) – A sheet metal assembly that is made up of mounting bars and side plates to which a backplane can be mounted and printed wiring boards can be inserted

**Resistance** – The opposition that a material or device offers to the flow of current, equal to the voltage drop across the element, divided by the current through the element.

**RFI** – Radio Frequency Interference.

**Risetime** – Often designated as tr, in picoseconds. It is the time it takes the signal to transition from 10 percent to 90 percent of its' final value.

**Skew** – The time difference between the arrival of two related signals, often due to differences in their propagation paths.

**Shroud** – A male connector body designed to fit over the extended tails of a long tail connector which allows a female connector to be mated from the rear side for midplane or rear I/O applications.

**Signal** – An electrical pulse which conducts across a backplane.

**Solder or Extended Tail** – A term used to specify the length of the pins on any connector. Typically the pins will protrude through the printed wiring board. Extended pins extend much further.

**Solder Mask** – The coating on a printed wiring board, placed there for protection. Also aids in assembly and soldering.

**S-Parameters** – A popular mathematical representation of high frequency characteristics of a component such as a connector utilized for signal integrity measurement and analytical techniques. Often utilized in applications where SPICE modeling is not practical.

**SPICE** – Software Program for Integrated Circuit Emulation. One of several computer based techniques for simulating the electrical performance of various circuit components such as connectors and integrated circuits within a actual or theoretical circuit configuration.

**Stripline** – (1) The name given to a signal, referenced between two ground planes, at a defined spacing.  
(2) The etched portion of a backplane transmission line that is between two ground planes in a multilayer printed circuit board.

**Subrack** – A card cage assembly, usually designed to support a backplane, card guides and daughter cards.

**Terminated** – A line or trace is considered terminated at any point there is a resistor connected to it.

**Tolerance** – The permissible variations in the dimensions of manufactured parts or electrical components.

**Trace** – The conductor that physically joins two or more points on a printed wiring board.

**Transition Board** - A perpendicular board assembly used to plug into extended connector terminals on the rear side of the backplane as in mid plane chassis designs or when it is not desirable to utilize cables to interface to the rear connectors.

**Transmission Line** – A line is referred to as a transmission line when its capacitance and inductance are distributed over the line. Such a line will convey a signal without distortion and will appear as a purely resistive input impedance.

**TTL** – Transistor-Transistor Logic. A logic circuit containing two transistors, for driving large output capacitances at high speed.

**Two Sided** – A printed wiring board with only the outer layers containing traces. This product may or may not contain plated through holes.

**U** – An EIA unit of measurement equal to 1.75" for equipment racks.

**Un-terminated** – Any bussed trace that is not connected.

**Vcc** – Typically, the collector voltage level for a transistor. The designation of the primary voltage level on a printed wiring board, usually at the potential of +5 volts.

**Via** – A plated through-hole that is there for the sole purpose of conducting a signal trace or potential from one layer of the printed wiring board to another.

**VITA** – The VME International Trade Association is a trade association that supports VME and other imbedded industry computer manufacturers. It also supports an ANSI recognized standards producing organization, the VSO. VITA's web address is <http://www.vita.com>

**VME** – The initials for the backplane bus architecture known as Versa-Module -Europa.

**Voltage** – The electromotive force determined by the potential difference between two conductors, measured in volts.

**VSO** – The VITA Standards Organization. An ANSI recognized standards producing organization concerned with computer architectures. See VITA.

**Wirewrap** – A termination technique, used mainly to prototype computers and computer systems, identifiable by the presence of elongated pins to which signal wires and voltage and ground connections can be created.

# ERNI Customer Request Form

If you need a specially loaded configuration for your application, please use this form. Fill out the grid diagram for the connector style you desire (A, B, C, or M) and mark which pin (A, B, C, D, E, F, K, L, M, N, P, Q, R, S or T) is required in each position. Unloaded positions or rows may be left blank.

Date Submitted \_\_\_\_\_

## Connector Type A

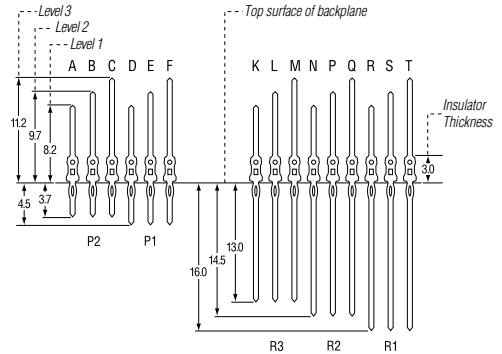
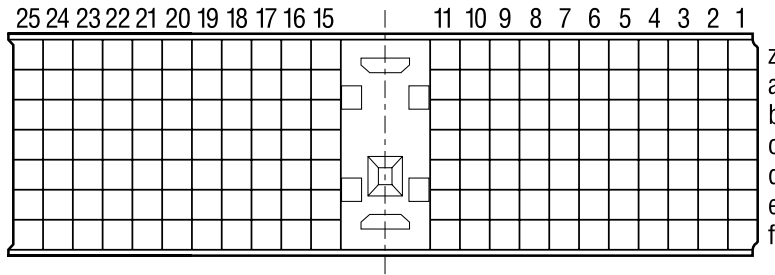

## Connector Type B

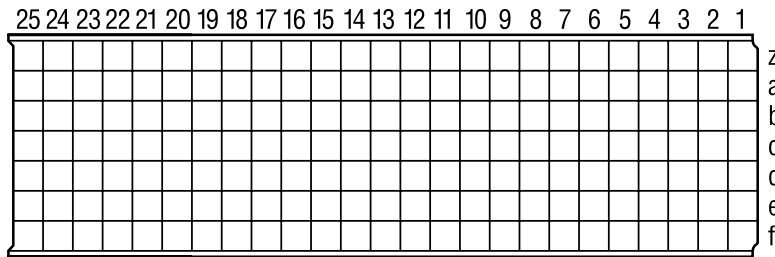

## Connector Type C

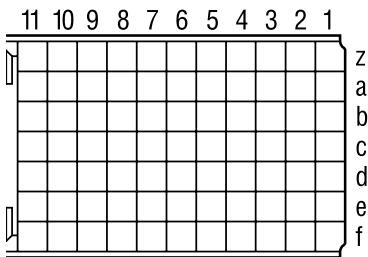

## Connector Type M

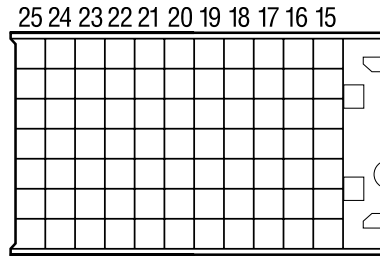

\_\_\_\_\_

*Sample Qty. Required*

\_\_\_\_\_

*Date Samples Needed*

\_\_\_\_\_

*Estimated Annual Usage*

\_\_\_\_\_

*Special Markings or Other Requirements*

\_\_\_\_\_

\_\_\_\_\_

\_\_\_\_\_

Connector with location peg     Connector without location peg

Name: \_\_\_\_\_ Tel: \_\_\_\_\_ Ext. \_\_\_\_\_

Title: \_\_\_\_\_ Fax: \_\_\_\_\_

Company: \_\_\_\_\_ E-mail: \_\_\_\_\_

Address: \_\_\_\_\_

City: \_\_\_\_\_ State: \_\_\_\_\_ Zip: \_\_\_\_\_





# ERNI Customer Request Form

If you need a specially loaded configuration for your application, please use this form. Fill out the grid diagram for the connector style you desire and mark which pin (A, B, C, D, E, F, K, L, M, N, P, Q, R, S or T) is required in each position. Unloaded positions or rows may be left blank.

Date Submitted \_\_\_\_\_

## Monoblock Connector

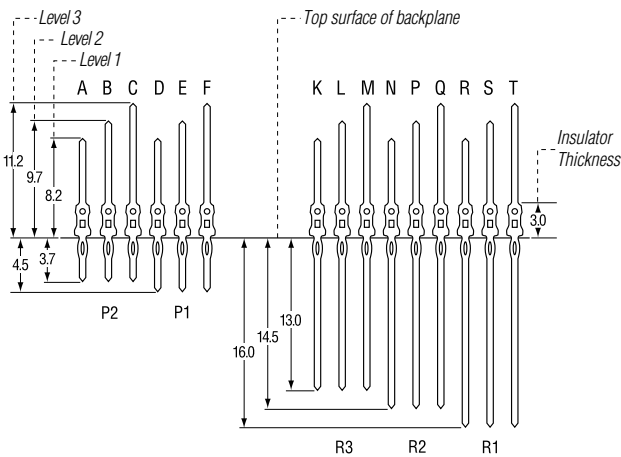
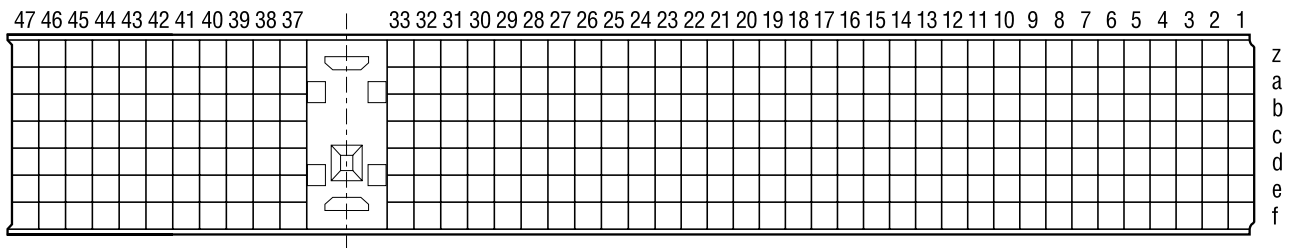

\_\_\_\_\_

*Sample Qty. Required*

\_\_\_\_\_

*Date Samples Needed*

\_\_\_\_\_

*Estimated Annual Usage*

\_\_\_\_\_

*Special Markings or Other Requirements*

\_\_\_\_\_

\_\_\_\_\_

Name: \_\_\_\_\_ Tel: \_\_\_\_\_ Ext. \_\_\_\_\_

Title: \_\_\_\_\_ Fax: \_\_\_\_\_

Company: \_\_\_\_\_ E-mail: \_\_\_\_\_

Address: \_\_\_\_\_

City: \_\_\_\_\_ State: \_\_\_\_\_ Zip: \_\_\_\_\_

# Applications

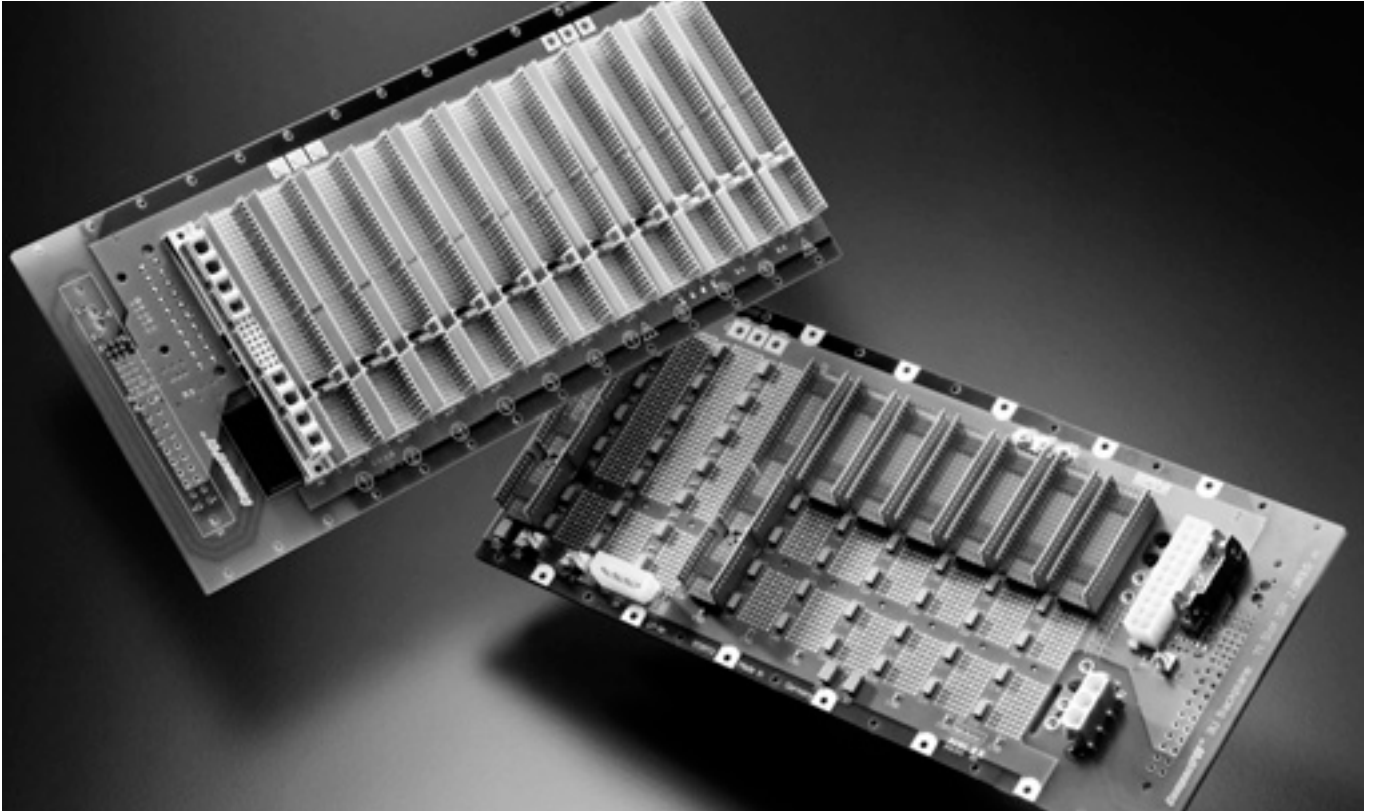

ERmet 2.0mm

