

PLEASE CHECK WWW.MOLEX.COM FOR LATEST PART INFORMATION

Part Number: [09-01-7064](#)
Status: **Active**
Overview: Edge Card Connectors
Description: 3.96mm Pitch KK® Crimp Housing, Edge Card Connector, Single-Sided, Surface Mount, Polarized, with Flange, 6 Circuits

Documents:

[3D Model](#) [Packaging Specification PK-2574-001 \(PDF\)](#)
[Drawing \(PDF\)](#) [RoHS Certificate of Compliance \(PDF\)](#)
[Product Specification PS-08-50 \(PDF\)](#)

Agency Certification

UL E29179

General

Product Family Edge Card Connectors
 Series [2574](#)
 Component Type Edgecard to Wire
 Overview [Edge Card Connectors](#)
 Product Name Edge Card, KK®
 UPC 800753844988

Physical

(p)ower-(s)ignal Configuration 6s - 0p
 Circuits (Loaded) 6
 Circuits (maximum) 6
 Color - Resin Natural
 Durability (mating cycles max) 25
 Entry Angle Vertical (Top Entry)
 Flammability 94V-2
 Keying to Mating Part N/A
 Material - Plating Mating N/A
 Material - Resin Nylon
 Net Weight 2.586/g
 PCB Retention None
 PCB Thickness - Recommended 1.60mm
 Packaging Type Bag
 Panel Mount With Flange
 Pitch - Mating Interface 3.96mm
 Polarized to Mating Part Yes
 Temperature Range - Operating 0°C to +75°C
 Termination Interface: Style N/A

Electrical

Current - Maximum per Contact 4.25A, 4.5A, 4.75A, 4A, 5A
 Voltage - Maximum 250V

Material Info

Old Part Number 2574-06B1

Reference - Drawing Numbers

Packaging Specification PK-2574-001
 Product Specification PS-08-50
 Sales Drawing SD-2574

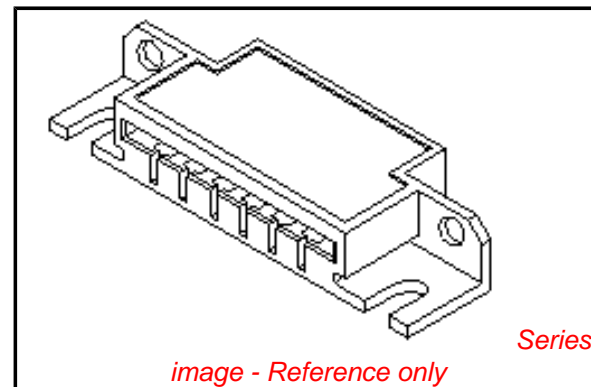

EU RoHS

ELV and RoHS Compliant
REACH SVHC Contains SVHC: No
Low-Halogen Status Low-Halogen

China RoHS



Need more information on product environmental compliance?

Email productcompliance@molex.com
 For a multiple part number RoHS Certificate of Compliance, [click here](#)

Please visit the [Contact Us](#) section for any non-product compliance questions.

Search Parts in this Series

[2574Series](#)

Mates With

PCB, 1.60mm Max. Thickness

Use With

[2878](#) Terminals, [2478](#) Terminals, [2578](#) Terminals, Bifurcated

This document was generated on 10/03/2014

PLEASE CHECK WWW.MOLEX.COM FOR LATEST PART INFORMATION