

Section

A

New
HW Dual Pushbutton
Switches now available.
See page A3-84.

Section A Overview

- Selection Guide A-2
- General Information A-12

A1: Safe Break E-Stops

- **World's Safest E-Stops**

New

- XA Ø 16mm &
XW Ø 22mm A1-14

A2: ø16mm Switches & Pilot Devices

- **A6 Series** Ø 16mm A2-17
- **L6 Series** Ø 16mm A2-30

A3: ø22mm Switches & Pilot Devices

- **HW Series** Ø 22mm A3-52
- **LW Series** Ø 22mm A3-108
- **TW Series** Ø 22mm A3-126

A4: ø30mm Switches & Pilot Devices

- **TWTD Series** Ø 30mm A4-166
- **Cam - CS Series** A4-195
- **Mono Lever - ARN Series** A4-202

A5: Miniature Switches & Pilot Devices

- **A8 Series** Ø 8mm A5-205
- **AP Series** Miniature Pilot Lights
Ø 8-16mm A5-210

Switches & Pilot Devices

www.idec.com/switches

for more information on this product family visit

www.idec.com/switches





Additional Web Resources

- New and updated product information
- Downloadable software demos & upgrades
- Part configuration tool & cross reference
- Online stock check & ordering
- IDEC field sales & distributor search
- Online literature request
- Downloadable manuals & CAD drawings
- Manufacturer's suggested retail price list
- Product training schedule & locations
- Advertising & trade show schedules
- Press releases & FAQs

Selection Guide





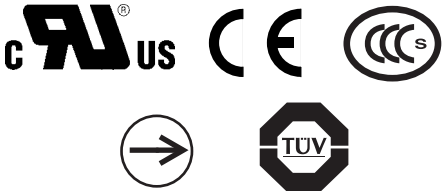
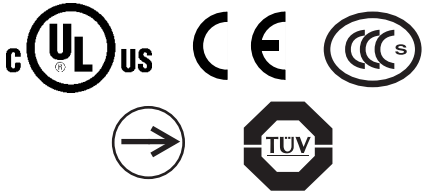





A1: Safe Break E-Stops: 16mm XA & 22mm XW Series

Switches & Pilot Devices

World's Safest Emergency Switches		
Series Model	XA	XW
Appearance		
See Page	A1-14	A1-14
Operator Type	Non-illuminated E-Stops: Pushlock/Turn Reset, Push-Pull	Illuminated & Non-Illuminated E-Stops: Pushlock/Turn Reset, Push-Pull
Reset Action	Pushlock Pull or Turn Reset (both actions available in each switch)	
Contact Configuration	1NO - 1NC, 2NC, 1NO-3NC, 4NC	1NO - 1NC, 2NC, 1NO-3NC, 4NC
Electrical Life	100,000 Minimum 250,000 or more (24V AC/DC 100mA)	
Mechanical Life	250,000 Minimum	
Termination	PCB & Solder Terminals	Screw Terminals
Degree of Protection	IP65 (IEC60529)	
Approvals		

 XA series UL recognized.

A2: Ø16mm Switches & Pilot Devices - A6 Series

Series Model	AL6	AB6	AL6	AB6	AB6-V	AS6	AS6-K
Appearance							
See Page	A2-20	A2-18	A2-20	A2-18	A2-18	A2-24	A2-24
Operator Type	Illuminated Pushbuttons: • Momentary • Maintained • Pilot Lights	Non-Illuminated Pushbuttons: • Momentary • Maintained	Oversize Lens Illuminated Pushbuttons: • Momentary • Maintained	Oversize Button Non-illuminated Pushbuttons: • Momentary • Maintained	Emergency Stop: • Pushlock / Turn Reset	Selector Switches: • 2 or 3-Position • Maintained or Spring Return	Keylock Switches: • 2 or 3-Position • Maintained or Spring Return • Key removable options
Bezel/Lens Shape & Size	Round: 18mm Square: 18mm Rectangular: 18 x 24mm		Round: 23.5mm Square: 23.5mm Rectangular: 17.5 x 23.5mm		Round: 23.5mm	Round: 18mm Square: 18mm Rectangular: 18 x 24mm	
Light Source	LED	—	LED	—	—	—	—
Lens/Button Colors	Amber, Green, Red, White, Yellow, Blue	Black, Blue, Green, Red, White, Yellow	Amber, Green, Red, White, Yellow, Blue	Black, Blue, Green, Red, White, Yellow	Red	Black	—
Contact Configuration	SPDT or DPDT (Gold-Clad Silver Contact)						
Contact Ratings	120V AC/1A, 24V DC/1A (Resistive) (Minimum applicable load reference value: 5V AC/DC, 1mA)						
Electrical Life	Momentary: 100,000 operations minimum Maintained: 50,000 operations minimum				100,000 operations	100,000 operations minimum (at 1,200 operations/hour)	
Mechanical Life	Momentary: 1,000,000 operations minimum Maintained: 100,000 operations minimum				100,000 operations	250,000 operations minimum	
Degree of Protection	Enclosed/Dustproof: IP40 Waterproof/Oiltight/Corrosion Resistant: IP65						
Termination	.110" Solder/Quick Connect						
Approvals	 UL Recognized File No. E55996		 CSA Certified File No. LR48366				Certificate No. 2030010305027380

A

Switches & Pilot Devices









































-  1. LED lamps contain a built-in current-limiting resistor and reverse polarity protection diode.
2. Available as assembled or sub-assembled components.

A2: Ø16mm Switches & Pilot Devices - L6 Series

Switches & Pilot Devices

Series Model	LAΔB/HAΔB	LAΔP/HAΔP	LAΔL/HAΔL	HA1B-V/ HA1E-V	LAΔS/HAΔS	LAΔK/HAΔK	LAΔF/HAΔF	LA3Z/LA1T/ HA1R
Appearance				 Direct Opening Action				
See Page	A2-30	A2-34	A2-36	A2-33	A2-38	A2-40	A2-42	A2-33, A2-44
Operator Types	Non-illuminated: • Momentary • Maintained	Pilot Light • LED/Incan.	Illuminated: • Momentary • Maintained • LED/Incan.	E-Stop • Pushlock/ Turn Reset	Selector Switch • 2 pos/ 3pos • Spring/Maint	Key Switch • 2pos/3pos • Spring/Maint • Key Remove Option	Illuminated Selector • 2 pos/ 3pos • Spring/Maint • LED/Incan.	Piezo Buzzer Lever Switch • 2 pos/ 3pos • Spring/Maint PB/ Selector • 2 pos/ 3pos
Bezel Shape and Size	Rnd: 18mm Sq: 18mm Rect: 18 x 24mm Ovrsize Rnd: 24mm Ovrsize Sq: 24mm	Rnd: 18mm Sq: 18mm Rect: 18 x 24mm Ovrsize Rnd: 24mm Ovrsize Sq: 24mm	Rnd: 18mm Sq: 18mm Rect: 18 x 24mm Ovrsize Rnd: 24mm Ovrsize Sq: 24mm	Rnd: 25mm		Rnd: 18mm Sq: 18mm Rect: 18 x 24mm Ovrsize Rnd: 24mm		BZR: 18 x 24mm Lvr: 18mm PB/Selector: 25mm
Light Source	-	LED: 5VDC/6V, 12V, 24V AC/DC Incan: 5V/6V, 12V, 24V AC/DC	LED: 5VDC/6V, 12V, 24V AC/DC Incan: 5V/6V, 12V, 24V AC/DC	-	-	-	LED: 5VDC/6V, 12V, 24V AC/DC Incan: 5V/6V, 12V, 24V AC/DC	-
Lens/Button Colors	Amber, Green, Red, Blue, White, Yellow	Amber, Green, Red, Blue, White, Yellow	Amber, Green, Red, Blue, White, Yellow	Red	Black/White	Black/Silver	Amber, Green, Red, Blue, White, Yellow	-
Contact Configuration	SPDT, DPDT	-	SPDT, DPDT	DPST-NC (positive action)		DPDT		DPDT
Electrical Life	100,000 operations min (at full rated load)	Incan: 2000 hrs LED: 50,000 hrs			100,000 operations min (at full rated load)			-
Mechanical Life	Momentary: 2,000,000 Maintained: 250,000	-	Momentary: 2,000,000 Maintained: 250,000	250,000 operations		Momentary: 2,000,000 Maintained: 250,000		-
Degree of Protection	IP65							
Termination	0.110" solder/quick connect, PCB pins							
Approvals	UL Recognized File No. E55996	CSA Certified File No. LR21451	TÜV Rheinland	Reg.No. R9551089 Reg. No. J9551458 Reg. No. J9650511			HA1B-V, HA1E only	



















A3: Ø22mm Oiltight Switches and Pilot Devices - HW Series

Series Model	HWΔB-	HWΔP-	HWΔL-	HW1B, HW1E	HW1S, HW1K, HW1F-	HW7D, HW1M, HW1R -
Appearance	Flush 		Flush 	Push-Pull 		
	Extended 		Flush (metal bezel) 	Pushlock Turn Reset 	Knob Operator 	NEW Dual Pushbutton 
	Extended (metal bezel) 	Dome Lens 	Flush (metal bezel) 	Pushlock Turn Reset (metal bezel) 	Knob Operator (metal bezel) 	Mono-Lever 
	40mm Mushroom 	Dome Lens (metal bezel) 	Extended 	Pushlock Turn Reset (metal bezel) 	Key Operator 	
	Square Flush 	Flush Lens 	Extended/Shroud 	Pushlock Key Reset 	Key Operator (metal bezel) 	Pushbutton Selector 
	Square Extended 	Square Flush 	40mm Mushroom 	Jumbo Pushlock Turn Reset 		
	Jumbo Mushroom 		Square Extended 	Unibody E-Stop 	Illuminated 	
				Illuminated Unibody E-Stop 		
See Page	A3-54	A3-61	A3-64	A3-52	A3-68, A3-71, A3-74	A3-84, A3-89, A3-91
Operator Types	Non-illuminated Pushbuttons: • Momentary • Maintained	Pilot Lights • LED/Incandescent	Illuminated Pushbuttons: • Momentary • Maintained • LED/Incandescent	E-Stops: • Modular or Unibody • Non-Illuminated • Illuminated (unibody only) • key reset (all units meet EN418)	Selector Switches • Non-Illuminated • Illuminated • LED/Incandescent • 2, 3, 4, 5- position (key & illum. 2 or 3-position only)	HW7D Dual Pushbutton HW1M Monolever • 2 or 4 position HW1R Selector Pushbutton
Contact Configuration	Modular: NO, NC, NO-EM, NC-LB (maximum 6 contacts)	—	Modular: NO, NC, NO-EM, NC-LB (maximum 6 contacts)	2NC, 1NO/1NC (Unibody)	Modular: NO, NC, NO-EM, NC-LB (maximum 6 contacts)	Modular: NO, NC, NO-EM, NC-LB (maximum 6 contacts)
Electrical Reliability	MTBF < 1 fault in 10 million operation cycles (3V DC, 5mA)					
Mechanical Life	Momentary Pushbuttons: 5,000,000 operations minimum (900 operations per hour) All other switches: 500,000					
Degree of Protection	IP65 (from front of the panel), IP20 (type HW-F contact blocks) (conforming to IEC60529) NEMA Type 1, 2, 3, 3R, 3S, 4, 4X, 5, 12, 13 (conforming to NEMA ICS-110)					HW1R: IP65, IP20 NEMA 1, 2, 3, 3R, 3S, 4, 4x, 5, 12, 13 HW1M: IP40, IP20
Termination	M3.5 screw terminals (fingersafe/spring-up/exposed screw) with captive sems plate					
Approvals	 UL Listed File No. E68961	 CSA Certified File No. LR92374		 TÜV Rheinland Reg No. R9551089 (E-stops) Reg No. J9551458 (all other switches) Reg No. J9650511 (Pilot Lights)	 Direct Opening Action (NC contacts only)	 Certificate No. 2005010305145656

Switches & Pilot Devices



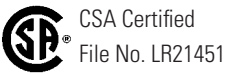























A3: Ø22mm Oiltight Switches and Pilot Devices - LW Series

Switches & Pilot Devices

Series Model	LWΔB-	LWΔL-	LW1S-	LW1F	LW1K	LWΔP-
Appearance	Flush 					Round 
	Extended 	Round 				Square 
	Square Flush 	Square 				Round Unibody 
	Square Extended 	Mushroom 				Square Unibody 
	Mushroom 					
See Page	A3-110	A3-112	A3-116	A3-116	A3-116	A3-114
Operator Type	Non-Illuminated Pushbuttons • Momentary • Maintained	Illuminated Pushbuttons: • Momentary • Maintained • LED/Incan.	Selector Switch: • 2 or 3- position	Illuminated Selector: • 2 or 3- position • LED/Incan.	Key Selector: • 2 or 3- position • Key removable options	Pilot Light • LED/Incan. • Standard/Unibody
Contact Configuration	SPDT, DPDT, 3PDT					—
Contact Ratings	Gold-clad crossbar contacts 30VDC/1A, 125VAC/1A resistive					—
	Silver Contacts 30VDC/2A, 125VAC/3A, 250VAC/2A resistive 30VDC/1A, 125VAC/2A, 250VAC/1.5A inductive					
Mechanical Life	Momentary: 1,000,000 operations minimum, Maintained: 500,000 operations, Selectors: 250,000 operations minimum					
Electrical Life (at rated load)	Momentary: 100,000 (1800 operations/hour) Maintained: 100,000 (900 operations/hour)					—
Degree of Protection (conforming to IEC529)	Oiltight/watertight: IP65					IP65
Termination	• .110" solder/quick connect • PCB (gold contacts only) • M3 screw (2 pole only)					
Approvals	 UL Recognized File No. E55996	 CSA Certified File No. LR21451	 TÜV Rheinland	Reg. No. J9551801		

 1. Lamps not included in assembled units.
2. Available as assembled or sub-assembled components.

A3: Ø22mm Oiltight Switches and Pilot Devices - TW Series

Series Model	AΔW...	AΔLW...	ASW...	ASLW...	APW...	
Appearance	Flush 	Extended 				
	Extended 	Extended/Shroud 	Knob Operator 		Dome Lens 	
	Mushroom 	Mushroom 	Lever Operator 	Knob Operator (w/transformer) 	Flush Lens 	
	Square Flush 	Square Extended 	Key Operator 		Square Flush 	
	Square Extended 	Push-Pull 			Square Flush (w/transformer) 	
	Pushlock Turn Reset 	Pushlock Turn Reset 				
See Page	A3-128	A3-138	A3-142	A3-146	A3-135	
Operator Types	Non-illuminated Pushbuttons: • Momentary • Maintained • E-Stop	Illuminated Pushbuttons: • Momentary • Maintained • E-Stop • LED/Incandescent	Selector Switches: • 2, 3, 4, 5-position • Maintained • Spring Return • Colored knobs/ inserts	Illuminated Selectors: • Full Voltage/ Transformer • LED/Incandescent	Pilot Lights: • Full Voltage/ Transformer • LED/Incandescent	
Contact Configuration	Modular: NO, NC, NO-EM, NC-LB (maximum 6 contacts)		See Contact Arrangement Charts page A3-150.		—	
Contact Ratings	10A thermal current/600V maximum					
Electrical Life	500,000 operations/min					
Mechanical Life	Momentary Pushbuttons: 5,000,000 operations minimum; Others: 500,000 operations minimum Selector Switches: 500,000 operations minimum					
Degree of Protection	NEMA Type 1, 2, 3, 3R, 4, 4X, 5, 12, 13; Waterproof/Oiltight/Corrosion Resistant: IP65					
Termination	M3.5 Screw Terminals with captive sems plate					
Approvals	 UL Listed File No. E70646	 CSA Certified File No. LR48366	 TUV Rheinland File No. 9561116E01		 Direct Opening Action (NC contacts only)	 Certificate No. 2030010305027380



























1. Illuminated units include lamp.
2. Available as assembled or sub-assembled components.

A4: Ø30mm Oiltight Switches and Pilot Devices - TWTD Series









A

Switches & Pilot Devices

Series Model	AΔD...	AΔLD...	ASD...	AΔLD...	APD...
Appearance	Flush 	Extended 	Knob Operator 	Knob Operator (full voltage) 	Dome Lens 
	Extended/ Neoprene Boot 	Extended/Shroud 	Lever Operator 	Knob Operator (with transformer) 	Dome Lens (w/transformer) 
	Mushroom 	Mushroom 	Key Operator 		
	Jumbo Mushroom 	Pushlock Turn Reset 			
	Pushlock Turn Reset 	Push-Pull 			
	Push-Pull 				
See Page	A4-168	A4-174	A4-179	A4-182	A4-174
Operator Type	Non-illuminated Pushbuttons: • Momentary • Maintained • E-Stop	Illuminated Pushbuttons: • Momentary • Maintained • Special (E-Stop) • LED/Incandescent	Selector Switches: • 2, 3-position • Maintained • Spring return • Key removable options	Illuminated Selectors • LED/Incandescent • 2, 3-position • Maintained • Spring return	Pilot Lights • Full Voltage/Transformer • LED/Incandescent
Contact Configuration	Modular: NO, NC, NO-EM, NC-LB (maximum 6 contacts)		See Contact Arrangement Charts on page A4-185.		—
Contact Ratings	10A thermal current 600V maximum				—
Electrical Life	500,000 operations minimum (pushbuttons and selector switches) Operating Frequency: 30 operations/minute, Duty Rate 40%				—
Mechanical Life	Momentary Pushbuttons: 5,000,000 operations minimum; Others: 500,000 operations minimum				
Degree of Protection	NEMA Type 1, 2, 3, 3R, 4, 4X, 5, 12, 13 Waterproof/Oiltight/Corrosion Resistant: IP65				
Termination	M3.5 Screw Terminals with captive sems plate				
Approvals	 UL Listed File No. E70646	 CSA Certified File No. LR48366	 File No. DK95-00717		 Certificate No. 2005010305145656

 1. Illuminated units include lamp.
2. Available as assembled or sub-assembled components.

A4: Ø30mm Switches - Cam and Mono-Lever

Series Model	ACSNO	ACSNK	UCSQO	UCSQM	ARN
Mounting Hole Diameter	Ø 1-13/64" (30mm)		5 hole panel cutout		Ø 1 13/64" (30mm)
Appearance					Standard Knob (ARNO)  Short Knob (ARNSO)  Interlock knob (ARNLO) 
See Page	A4-195				A4-202
Operator Types	Cam Switch w/knob selector	Cam Switch w/key selector	Cam Switch w/knob & mechanical indicator.	Cam Switch 3-pos, spring-return	Mono-lever Switch
Cam Angles and/or Positions	30° Up to 12 positions 45° Up to 8 positions 60° Up to 6 positions 90° Up to 4 positions			Spring-return 45° 3 position only	<ul style="list-style-type: none"> Center + 2, 3, or 4 position Maintained Spring return
Contact Ratings	10A thermal current 600V insulation voltage				
Electrical Life:	500,000 operations minimum (at full rated load)				
Mechanical Life	500,00 operations minimum				
Degree of Protection	IP65, NEMA 4, 13	IP40	IP65, NEMA 4, 13		IP40
Termination	M3.5 Screw Terminals with captive sems plate				
Approvals	 UL Listed File No. E68961		 CSA Certified File No. LR48366		







1. Cam switches available only as assembled units.
2. Mono-lever switches available as assembled or sub-assembled components.













A5: Miniature Switches and Pilot Devices - Ø8mm A8 Series

Switches & Pilot Devices

Series Model	AL8	AB8
<p>Appearance</p>		
<p>See Page</p>	<p>A5-205</p>	<p>A5-205</p>
<p>Operator Type</p>	<p>Illuminated Pushbuttons: • Momentary • Maintained • Pilot Lights</p>	<p>Non-Illuminated Pushbuttons: • Momentary • Maintained</p>
<p>Lens Shape and Size</p>	<p>Round: Ø 0.351 (9mm) Square: □ 0.351 (9mm) Rectangular: 0.351 x 0.468 (9 x 12mm)</p>	
<p>Light Source</p>	<p>LED</p>	<p>—</p>
<p>Lens/Button Colors</p>	<p>Amber, Green, Red, White, Yellow</p>	<p>Black, Blue, Green, Red, White, Yellow</p>
<p>Contact Configuration</p>	<p>SPDT (Gold-Clad Silver Contact)</p>	
<p>Contact Ratings</p>	<p>120V AC/1A, 24V DC/1A, (Resistive), Minimum applicable load reference value: 5V AC/DC, 1mA</p>	
<p>Electrical Life (at full rated load)</p>	<p>Momentary: 100,000 operations minimum Maintained: 50,000 operations minimum</p>	
<p>Mechanical Life</p>	<p>Momentary: 200,000 operations minimum Maintained: 100,000 operations minimum</p>	
<p>Degree of Protection</p>	<p>Enclosed/Dustproof: IP40</p>	
<p>Termination</p>	<p>Solder Tab Terminal</p>	
<p>Approvals</p>	<div style="display: flex; justify-content: space-around; align-items: center;"> <div style="text-align: center;">  <p>UL Recognized File No. E55996</p> </div> <div style="text-align: center;">  <p>CSA Certified File No. LR21451</p> </div> </div>	

-  1. LED lamps require an external current limiting resistor.
 2. Available as assembled units only (replacement LED lamps available).

A5: Miniature Pilot Lights - Ø8 to 16mm AP Series

Series Model	AP8M	AP1M	AP2M	AP6M
Mounting Hole Diameter	8mm	10mm	12mm	16mm
Appearance	Dome 	Dome 	Dome 	Dome 
	Flat 	Flat 	Flat 	Flat 
See Page	A5-211			
Operator Type	Pilot Lights			
Lens Shape and Size	Flat & Dome Ø 9.8mm	Flat & Dome Ø 12mm	Flat & Dome Ø 14mm	Flat & Dome Ø 18mm
Light Source	LED (with built-in current limiting resistor)			
Lens Colors	Amber, Green, Red, White, Yellow			
Voltages	6, 12, 24V DC (Full Voltage)		6, 12, 24V DC (Full Voltage); 120, 240V AC (with transformer); 110V DC (with DC-DC converter).	
Rated Current	6V DC/18mA 12V DC/11mA 24V DC/12mA	6V DC/18mA 12V DC/11mA 24V DC/12mA	6V DC/33mA 12V DC/22mA 24V DC/11mA	6V DC/33mA 12V DC/11mA 24V DC/11mA
Degree of Protection	Enclosed/ Dustproof: IP40		Waterproof/Oiltight/Corrosion Resistant: IP65	
Termination	Solder Tab			.110" Solder/Quick Connect
Approvals	 UL Recognized File No. E68961		 CSA Certified File No. LR48366	



1. Only AP6 accepts .110" quick-connect.
2. AP2 and AP6 compatible with snap-on transformers.
3. All units are one-piece pilot lights with non-replaceable LED lamp.
4. All units include built-in current limiting resistor and reverse polarity protection diode.

General Information

Information About LED Lamps

Light-emitting diodes (LEDs) are P–N junction semiconductors with mechanisms called “junction electro-luminescence.” Application of direct current results in radiation or emission of a monochromatic light.

Different semiconductor materials produce different wavelengths of light as shown below:

Specifications	Green	Gallium Phosphide (GaP)	5600 Å
	Yellow	Gallium Arsenide Phosphide (GaAsP)	5800 Å
	Amber	Gallium Arsenide Phosphide (GaAsP)	6300 Å
	Red	Gallium Arsenide Phosphide (GaAsP)	6600Å
	Infrared	Gallium Arsenide (GaAs)	9000 Å

Advantages of Using LEDs

- LEDs are used when heat generated by incandescent lamps would damage nearby equipment or interfere with a precision process. This is particularly advantageous when multiple lights are grouped.
- LEDs can operate at low temperatures which would cause incandescent lamps to fail, since glass cracks during rapid cooling.
- LEDs consume 50 times less power than incandescent lamps, thereby reducing energy consumption.
- LEDs last 500 times longer than incandescent lamps. LEDs average a million hours (114 years) while incandescent lamps average 2000 hours.
- LEDs do not generally “blow out” unless subjected to a severe overvoltage. They exhibit a half-life type dimishment in brightness over time. After 50,000 hours (6 years) of use, IDEC LEDs will retain approximately half of their original intensity.
- IDEC’s SUPERBRIGHT LEDs have high visibility.
- LEDs require little or no maintenance because of long life and high reliability.

IDEC Recommendations

For optimum results, especially when using switches and pilot lights in operating environments which are conducive to overheating, use IDEC LED illuminated units. Transformers are available for use with incandescent illuminated units, which operate at lower voltages to avoid overheating.

When IDEC’s L-120L lamp is used, make sure ambient temperatures do not exceed 30°C (86°F). If a lamp from another supplier is used, it should be rated for less than 1.8 watts (15mA at 120V AC), with ambient temperatures as stated above.

Information About Incandescent Lamps

Filament-type incandescent lamps operate within the following parameters.

Light output and life expectancy depend on operating voltage. Light output varies to the 3rd or 4th power of the voltage. Life expectancy varies inversely to the 12th power of voltage. In other words, over-voltage of 5% reduces life expectancy by 50%. Under-voltage of 5% doubles life expectancy at the price of light output efficiency.

Inrush current (initial current through the filament) has an adverse effect on life expectancy. Cold resistance (room temperature) will have a more detrimental effect than hot resistance to inrush current. Life expectancy of incandescent lamps can be maximized by reducing occurrences of cold resistance to inrush current.

Continued intermittent flashing will significantly reduce life expectancy. When using an incandescent lamp with a tungsten filament, flashing will not reduce life expectancy as long as light output does not exceed that of steady burning.

When an incandescent lamp must withstand shock and vibration, use low voltage/high amperage (5–6V/60–120mA) lamps. These lamps have a short, thick filament with a high resonant frequency.

Provide cooling by using a heat sink, particularly when multiple incandescent lamps are grouped or when air circulation is limited. Make sure ambient temperatures do not exceed 100°C (212°F) for maximum life of incandescent lamps.

Comparison: LED vs. Incandescent Lamps

		Superbright LEDs	Incandescent
Characteristics	Heat Dissipation	Very Low	High
	Life Expectancy	Very Long	Short
	Reliability	Very High	Low
	Mechanical Strength	Not Susceptible	Susceptible to Shock/Vibration
	Maintenance Required	Negligible	Frequent
	Operation at Low Temps.	Possible	Not Possible
	Inrush Current	Negligible	Very Large
	Voltage Effects on Life	Insignificant	Significant
	Brightness	Slightly Less	Slightly More



Ordering Information

1. IDEC offers assembled and sub-assembled switches and pilot lights for your convenience. In some cases there is a cost difference, with sub-assembled units costing slightly less. Since assembled units are custom made to your order, a couple of days for assembly is added to delivery. To minimize delivery or inventory requirements, it is suggested that switches and pilot lights be ordered as sub-components.
2. When ordering pilot lights or illuminated pushbuttons, make sure to specify the color code in place of the asterisk in the part number, (LED or incandescent lamp included). Spare lamps can be ordered and are listed with sub-assembly components.
3. Accessories, such as locking ring wrench, lens removal tool, and lamp holder, are available to make installation and assembly easier. IDEC recommends using these accessories and is not responsible for damage as a result of using the wrong tool.
4. Marking plates are available for switches and pilot lights which feature a flat lens. Printed mylar (not included) can also be inserted under lens for labeling purposes.
5. Nameplates are available for TW, 7/8" (22mm), HW 7/8" (22mm), and TWTD series, Ø1-13/64" (30mm). For prompt delivery, order standard legends. Custom engraving is also offered for an additional charge.

Installation and Operation

1. Use the appropriate lamp holder to remove or install LED or incandescent lamps. Using pliers will damage the lamp.
2. When mounting switches and pilot lights into a panel, use locking ring wrench. Using pliers or tightening excessively will damage the locking ring.
3. A series, 21/64" (8mm), can be mounted on a panel 0.019" (0.5mm) to 0.236" (6mm) thick.
4. TW, 7/8" (22mm) and TWTD series, Ø1-13/64" (30mm), feature an adjustment ring for mounting on a panel 0.038" (1mm) to 0.236" (6mm) thick. Using a nameplate or an anti-rotation ring adds 0.031" (0.8mm) to the panel thickness.
5. When applicable, solder terminals within 20W/5sec or 260°/3sec without exerting external force to the terminals. Use a non-corrosive resin liquid flux.
6. The operating voltage for LED units represents a complete DC value. When using a pulsing voltage, such a full-wave rectification, keep peak currents within the forward current I_f . Peak currents exceeding I_f may shorten the life of the LED lamp.
7. To avoid a short circuit, never connect NO and NC contacts to different voltages or power sources.
8. Optimum performance of TW and TWTD illuminated pushbuttons, selector switches, and pilot lights is obtained with IDEC LED and incandescent lamps.
9. For maximum life of incandescent lamps (approximately 2000 hours), use within the rated operating voltage. If it is necessary to use a higher voltage, keeping ambient temperature below 30°C (86°F) will help prolong the life of an incandescent lamp.



If excessive voltage is applied (over 50V), the lamp may blow and the lens holder may pop out.

16mm XA & 22mm XW E-Stops

Key features of the XA and XW E-Stops include:

- Lead-free (RoHS compliant)
- The depth behind the panel is only 48.7mm for 4 contacts (XW Series)
- IDEC's original "Safe Break Action" ensures the contacts open if the contact block is separated from the operator
- Pushlock Reset and Push-Pull in the same switch
- Direct opening action mechanism (IEC60947-5-5, 5.2, IEC60947-5-1, Annex K)
- Safety lock mechanism (IEC60947-5-5, 6.2)
- Degree of protection IP65 (IEC60529)
- Screw terminal is finger-safe (IP20)
- Two button sizes: 40mm and 60mm (XW Series)
- Rated Insulation Voltage - 16mm 300V, 22mm 250V
- Rated Thermal Current 5A
- UL, c-UL Listed, CE marked (XA Series UL recognized)

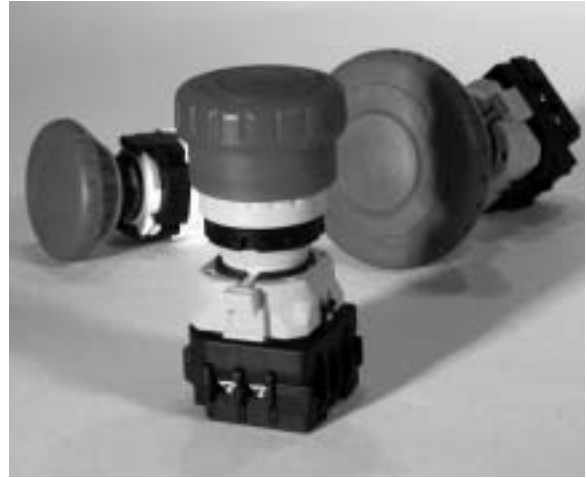

A1

Switches & Pilot Devices



XA & XW Series, The Safe Break Action E-Stops!

If the E-Stop is installed incorrectly or shifts in shipment, the contacts and switch can separate, which cause the NC contacts to remain closed during an emergency and the machine to continue running!



OR





With IDEC's revolutionary "Safe Break Action," the NC contacts will automatically open when the contacts are removed from the operator. This feature places the machine in a non-operational state.

		XA	XW	
Specifications	Conforming to Standards	IEC60947-5-1, EN60947-5-1, IEC60947-5-5, EN60947-5-5, JIS C8201-5-1, UL508, CSA C22.2 No.14		
	Standard Operating Conditions	Operating Temperature	Non-illuminated: -25 to +60°C Without Freezing Illuminated: -25 to +55°C Without Freezing	
		Operating Humidity	45 to 85%RH Without Condensing	
		Storage Temperature	-45 to +80°C	
	Operating Force	Pushlock: 10.5N, Pull Reset: 10N, Turn Reset: 0.16N-m	Pushlock: 32N, Pull Reset: 21N, Turn Reset: 0.27N-m	
	Minimum Force to Latch	60N	80N	
	Maximum Travel to Latch		4.0mm	
	Maximum Travel		4.5mm	
	Shock Resistance		Operating Extremes: 150m/s ² (15G) Damage Limits: 1000m/s ² (100 G)	
	Vibration Resistance		10 to 500Hz, Amplitude 0.35mm Acceleration 50m/s ² (5G) 10 to 500Hz, Amplitude 0.35mm Acceleration 50m/s ² (5G)	
	Life	Mechanical	250,000 Minimum	
		Electrical	100,000 Minimum 250,000 or more (24V AC/DC 100mA)	
	Degree of Protection		IP65 (IEC60529)	
	Short-Circuit Protection		250V/10A Fuse (Type aM IEC60269-1/IEC60269-2)	
Terminal Shape		Solder Terminal, PCB Terminal	M3 Screw Terminal	
Applicable Wire Size		Solder/PCB Terminal: 1.25mm ² Maximum (AWG 16 Maximum)	Screw Terminal: 0.75 to 1.25mm ² (AWG 18 to 16)	
Soldering		20W/5sec Maximum, 260°C/3sec Maximum	—	
Recommended Terminal Torque		—	0.6 to 1.0N-m	
Weight (Approx.)		40mm Button: 28 grams	40mm Button: 72 grams, 60mm Button: 81 grams	

XA & XW Series (assembled)

Part Numbers: 16mm XA Mushroom Button E-Stop

Style	Terminal	Contacts	Part Number
40mm Mushroom 	PCB Terminals	1NO - 1NC	XA1E-BV411V-R
		2NC	XA1E-BV402V-R
		1NO-3NC	XA1E-BV413V-R
		4NC	XA1E-BV404V-R
40mm Mushroom 	Solder Terminals	1NO - 1NC	XA1E-BV411-R
		2NC	XA1E-BV402-R
		1NO-3NC	XA1E-BV413-R
		4NC	XA1E-BV404-R

Part Numbers: 22mm XW LED Illuminated Mushroom Button E-Stop

Style	Terminal	Contacts	Part Number
40mm Mushroom 	Screw Terminals	1NO - 1NC	XW1E-LV411Q4M-R
		2NC	XW1E-LV402Q4M-R
		1NO-3NC	XW1E-LV413Q4M-R
		4NC	XW1E-LV404Q4M-R



Illumination is with built-in 24V AC/DC LED.

Part Numbers: 22mm XW Mushroom Button E-Stops

Style	Terminal	Contacts	Part Number
40mm Mushroom 	Screw Terminals	1NO - 1NC	XW1E-BV411M-R
		2NC	XW1E-BV402M-R
		1NO-3NC	XW1E-BV413M-R
		4NC	XW1E-BV404M-R

Part Numbers: 22mm XW Jumbo Mushroom Button E-Stops



Style	Terminal	Contacts	Part Number
60mm Mushroom 	Screw Terminals	1NO - 1NC	XW1E-BV511M-R
		2NC	XW1E-BV502M-R
		1NO-3NC	XW1E-BV513M-R
		4NC	XW1E-BV504M-R

A1

Switches & Pilot Devices

Accessories

Part Numbers: Nameplates

HWAV-Yellow Plastic				
 				
	Style	Part Number	ID	OD
XA	16mm Blank ø60mm	HAAV4-0	16mm	60mm
	16mm "Emergency Stop" ø60mm	HAAV4-27*	16mm	60mm
XW 40mm	22mm Blank ø60mm	HWAV-0	22mm	60mm
	22mm "Emergency Stop" ø60mm	HWAV-27*	22mm	60mm
XW 60mm	22mm Blank ø80mm	HWAV5-0	22mm	80mm
	22mm "Emergency Stop" ø80mm	HWAV5-27*	22mm	80mm



*Comes marked "Emergency Stop" as shown.

Part Numbers: 22mm E-Stop Shrouds

Style	Part Number
	HW9Z-KG1-TK2120
	HW9Z-KG2-TK2120



1. Not applicable for 60mm mushroom.
2. Applicable for XW (22mm) series only.

Dimensions

XA Dimensions

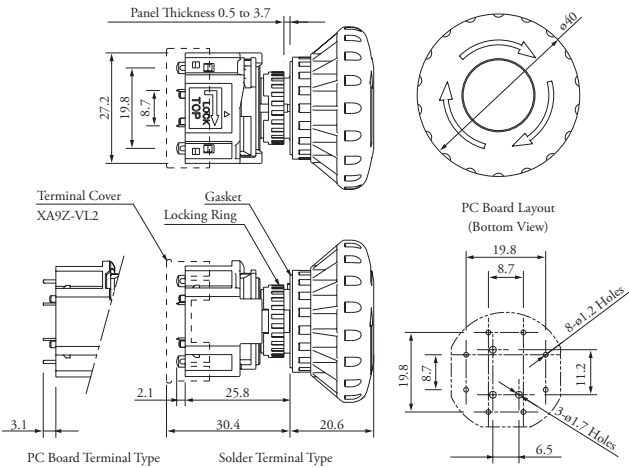

XW Dimensions

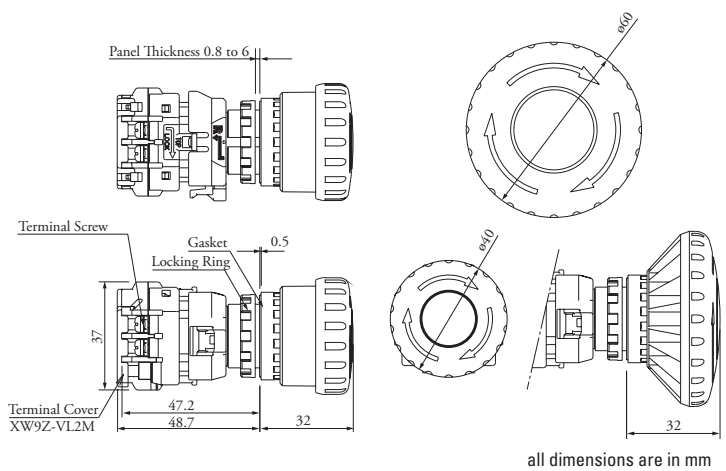

Connection Diagrams & Panel Cutouts

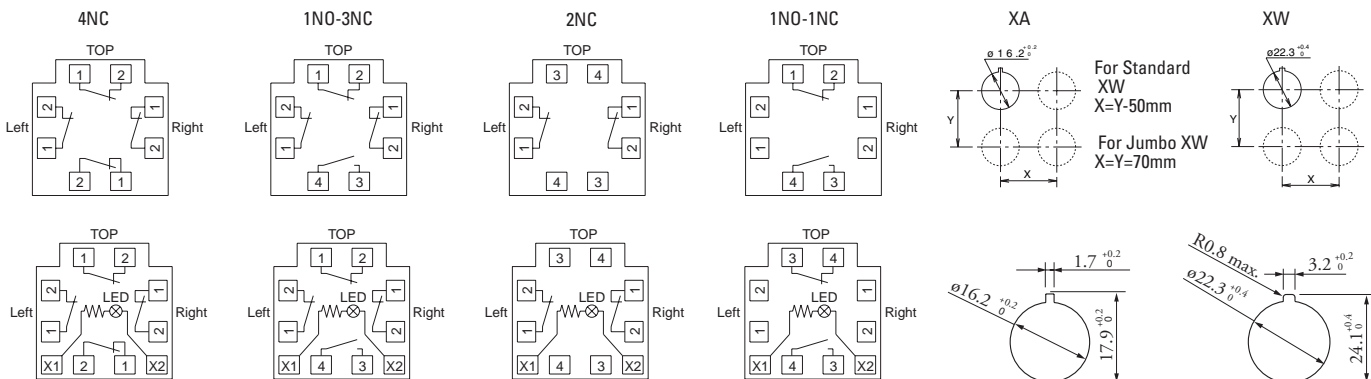

A6 Series — Miniature Switches and Pilot Devices: 16mm

Key features of the A6 series switches and pilot lights include:

- 16mm (5/8") mounting hole
- LED illumination
- Compact design saves space
- Momentary, Maintained, Selectors, and E-Stops
- Gold-clad Silver contacts for reliable low level switching
- Snap action contacts
- IP40 (dustproof) or IP65 (oiltight) versions



A2

Switches & Pilot Devices



UL Recognized
File No. E55996



CSA Certified
File No. LR21451



Certificate No.
2030010305027380

Specifications	Degree of Protection	IP40: Dustproof IP65 Waterproof/Oiltight/Corrosion Resistant			
	Contact Configuration	SPDT, DPDT			
	Maximum Voltage	250V AC/DC			
	Thermal Current	3A			
	Minimum Applicable Load	5V AC/DC, 1mA (subject to operating conditions)			
	Contact Material	Gold-clad silver			
	Terminal Style	.110" Solder/ Quick Connect			
	Operating Temperature	LED Type: -25° to +55°C (no freezing)			
	Operating Humidity	45 to 85% RH			
	Contact Resistance	50mΩ maximum (initial value)			
	Insulation Resistance	100MΩ minimum (500V DC megger)			
	Vibration Resistance	10 to 55Hz, amplitude 1.5mm p-p			
	Shock Resistance	Damage limits: 500m/sec ² (approx. 50G) Operating extremes: 200m/sec ² (approx. 20G)			
Electrical Life	100,000 operations minimum (at full rated load)				
Mechanical Life	Maintained: 100,000 operations minimum Momentary: 1,000,000 operations minimum Selector/Keylock: 250,000 operations minimum				
Dielectric Strength	Switch Unit: 2,000VAC, 1 min. between live/dead part and terminals of different poles; 1,000V AC, 1 minute between terminals of the same pole; 1,500V AC, 1 minute between contact and lamp terminals. Illumination Unit: 2,000VAC, 1 min. between live part/ground				
Soldering Temperature	20W/5 seconds or 260°C/3 seconds				
Contact Ratings	Operating Voltage	24V	120V	240V	
	AC (50/60Hz)	Resistive	—	1.0A	0.5A
		Inductive	—	0.7A	0.5A
	DC	Resistive	1.0A	0.2A	—
Inductive		0.7A	0.1A	—	
LED Lamp Ratings	Rated Voltage/Current	5V DC ±5%	6V AC/DC (±10%)	12V AC/DC (±10%)	24V AC/DC (±10%)
		8mA	DC: A, R, W, Y: 6mA G, S: 5mA AC: A, R, W, Y: 8mA G, S: 7mA	DC: 8mA AC: 9mA	DC: 8mA AC: 9mA







1. AC Inductive Load, PF = 0.6 – 0.7; DC Inductive Load, L/R = 7ms.
2. Minimum applicable load (reference value) is 5V AC/DC/1mA (applicable range is subject to the operating conditions and load).
3. LED lamp contains a built-in current-limiting resistor and a protection diode.
4. LED's don't "burn out." Luminance is reduced to 50% of initial intensity after being lit for 50,000 hours continuously.

A2

Switches & Pilot Devices

AB6 Non-Illuminated Pushbuttons (Assembled)

Part Numbers: Non-Illuminated Pushbuttons

	Style	Contact	Part Number			
			Momentary		Maintained (Latching)	
			Dustproof (IP40)	Oiltight (IP65)	Dustproof (IP40)	Oiltight (IP65)
Standard Button	Round 18mm 	SPDT DPDT	AB6M-M1-① AB6M-M2-①	AB6M-M1P-① AB6M-M2P-①	AB6M-A1-① AB6M-A2-①	AB6M-A1P-① AB6M-A2P-①
	Square 18mm 	SPDT DPDT	AB6Q-M1-① AB6Q-M2-①	AB6Q-M1P-① AB6Q-M2P-①	AB6Q-A1-① AB6Q-A2-①	AB6Q-A1P-① AB6Q-A2P-①
	Rectangular 18mm x 24mm 	SPDT DPDT	AB6H-M1-① AB6H-M2-①	AB6H-M1P-① AB6H-M2P-①	AB6H-A1-① AB6H-A2-①	AB6H-A1P-① AB6H-A2P-①
Oversize Button	Round 23.5mm 	SPDT DPDT	-	AB6M-M1P-M① AB6M-M2P-M①	-	AB6M-A1P-M① AB6M-A2P-M①
	Square 23.5mm 	SPDT DPDT	-	AB6Q-M1P-Q① AB6Q-M2P-Q①	-	AB6Q-A1P-Q① AB6Q-A2P-Q①
	Rectangular 17.5 X 23.5mm 	SPDT DPDT	-	AB6Q-M1P-H① AB6Q-M2P-H①	-	AB6Q-A1P-H① AB6Q-A2P-H①

① Button Color Code

Color	Code
Black	B
Green	G
Red	R
Blue	S
White	W
Yellow	Y



- In place of ①, specify Button Color Code from the table at the right.
- To order as sub-assembled, see page A2-19.
- For accessories, see page A2-25.
- For dimensions, see page A2-27.

Part Numbers: AB6-V Pushlock Turn Reset

Shape	Operation	Contact	Part Number		Remarks
			Dustproof (IP40)	Oiltight (IP65)	
23.5mm Round Mushroom 	Pushlock Turn Reset	SPDT DPDT	AB6M-V1-R AB6M-V2-R	AB6M-V1P-R AB6M-V2P-R	1. Button available in red only. 2. Replacement button: order AB6M-V-R

Part Numbers: Buzzer

Style	Shape	Voltage	Part Number
	Round (18mm)	12V DC	UZ6-11
		24V DC	UZ6-12

AB6 Non-Illuminated Pushbuttons (Sub-Assembled)



Part Numbers: Operators

Style	Contact	Operator	Part Number		
			Round	Square	Rectangular
Non-Illuminated Pushbuttons 	SPDT	Momentary	AB6M-M100	AB6Q-M100	AB6H-M100
		Maintained	AB6M-A100	AB6Q-A100	AB6H-A100
	DPDT	Momentary	AB6M-M200	AB6Q-M200	AB6H-M200
		Maintained	AB6M-A200	AB6Q-A200	AB6H-A200

Part Numbers: Buttons/Lens

Description	Part Number	
	Button	
	Dustproof (IP40)	Oiltight (IP65)
Round 	AB6M-BK1-①	AB6M-BK2-①
Square 	AB6Q-BK1①	AB6Q-BK2-①
Rectangular 	AB6H-BK1-①	AB6H-BK2-①
Round Oversize 	–	AB6M-BK2-M①
Square Oversize 	–	AB6Q-BK2-Q①
Rectangular Oversize 	–	AB6Q-BK2-H①

① Button Color Code

Color	Code
Black	B
Green	G
Red	R
Blue	S
White	W
Yellow	Y









- In place of ①, specify Button Color Code from table on right.
- Buttons which are rated IP65 include a waterproof rubber gasket.
- For accessories, see page A2-25.

AL6 Illuminated Pushbuttons (Assembled)

Part Numbers: LED Illuminated Pushbuttons

A2

Switches & Pilot Devices

Description	Style	Voltage	Contact	Part Numbers			
				Momentary		Maintained (Latching)	
				Dustproof (IP40)	Oiltight (IP65)	Dustproof (IP40)	Oiltight (IP65)
Standard Lens	Round 18mm diameter 	24V AC/DC ±10%	SPDT DPDT	AL6M-M14-② AL6M-M24-②	AL6M-M14P-② AL6M-M24P-②	AL6M-A14-② AL6M-A24-②	AL6M-A14P-② AL6M-A24P-②
	Square 18mm 	24V AC/DC ±10%	SPDT DPDT	AL6Q-M14-② AL6Q-M24-②	AL6Q-M14P-② AL6Q-M24P-②	AL6Q-A14-② AL6Q-A24-②	AL6Q-A14P-② AL6Q-A24P-②
	Rectangular 18mm x 24mm 	24V AC/DC ±10%	SPDT DPDT	AL6H-M14-② AL6H-M24-②	AL6H-M14P-② AL6H-M24P-②	AL6H-A14-② AL6H-A24-②	AL6H-A14P-② AL6H-A24P-②
Oversize Lens	Round 24mm diameter 	24V AC/DC ±10%	SPDT DPDT	-	AL6M-M14P-M② AL6M-M24P-M②	-	AL6M-A14P-M② AL6M-A24P-M②
	Square 24 mm 	24V AC/DC ±10%	SPDT DPDT	-	AL6Q-M14P-Q② AL6Q-M24P-Q②	-	AL6Q-A14P-Q② AL6Q-A24P-Q②
	Rectangular 18mm x 24mm 	24V AC/DC ±10%	SPDT DPDT	-	AL6Q-M14P-H② AL6Q-M24P-H②	-	AL6Q-A14P-H② AL6Q-A24P-H②

- 1. In place of ②, specify Lens/LED Color Code from table below.
- 2. Lamps also available in 5V DC, 6V AC/DC or 12 V AC/DC, change "4" using voltage/lamp codes (ie AL6M-M13-② uses 12V AC/DC LED).
- 3. LED lamp is included in unit and contains a current-limiting resistor and a protection diode. (External resistor not required.)
- 4. To order as sub-assembled, see page A2-21.
- 5. For accessories, see page A2-25.
- 6. For dimensions, see page A2-27.

② Lens/LED Color Code

Color	Code
Amber	A
Green	G
Red	R
Blue	S
White	W
Yellow	Y

Voltage Code

Voltage	Code
5V DC	1
6V AC/DC	2
12V AC/DC	3
24V AC/DC	4

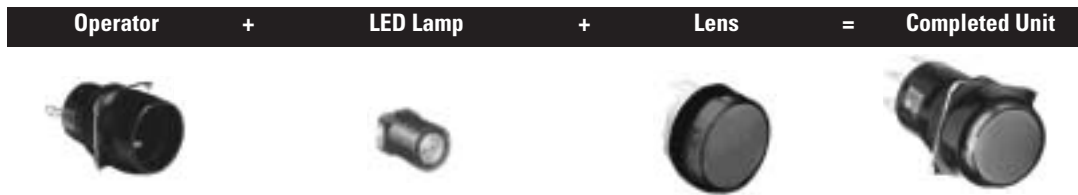

AL6 Illuminated Pushbuttons (Sub-Assembled)



Part Numbers: Operators

Style	Contact	Operator	Part Number		
			Round	Square	Rectangular
AL6 Illuminated Pushbuttons 	SPDT	Momentary	AL6M-M100	AL6Q-M100	AL6H-M100
		Maintained	AL6M-A100	AL6Q-A100	AL6H-A100
	DPDT	Momentary	AL6M-M200	AL6Q-M200	AL6H-M200
		Maintained	AL6M-A200	AL6Q-A200	AL6H-A200

Part Numbers: Lenses

Unit	Part Number		
Degree of Protection	Dustproof (IP40)	Oiltight (IP65)	
Size	Standard	Standard	Oversize
Round	AL6M-LK1-② 	AL6M-LK2-② 	AL6M-LK2-M② 
Square	AL6Q-LK1-② 	AL6Q-LK2-② 	AL6Q-LK2-Q② 
Rectangular	AL6H-LK1-② 	AL6H-LK2-② 	AL6Q-LK2-H② 



- In place of ②, specify Lens Color Code from table below.
- Lenses which are rated IP65 include a waterproof rubber gasket.
- For accessories, see page A2-25.

②Lens/LED Color Code

Color	Code
Amber	A
Green	G
Red	R
Blue	S
White	W
Yellow	Y

Part Numbers: LED Lamps

Appearance	Rated Voltage	Part Number
	5V DC	LATD-5②
	6V AC/DC	LATD-6②
	12V AC/DC	LATD-1②
	24V AC/DC	LATD-2②





In place of ②, specify LED Color Code from table at left.

AL6 Pilot Lights (Assembled)

Part Numbers: LED Pilot Lights

A2

Switches & Pilot Devices

Description	Voltage	Part Number	
		Dustproof (IP40)	Oiltight (IP65)
Round (18mm Lens) 	24V AC/DC	AL6M-P4-②	AL6M-P4P-②
Square (18mm Lens) 	24V AC/DC	AL6Q-P4-②	AL6Q-P4P-②
Rectangular (18mm x 24mm Lens) 	24V AC/DC	AL6H-P4-②	AL6H-P4P-②

② Lens/LED Color Code

Color	Code
Amber	A
Green	G
Red	R
Blue	S
White	W
Yellow	Y



1. In place of ②, specify LED/Lens Color Code.
2. Lamps also available in 5V DC, 6V AC/DC or 12 V AC/DC, change "4" using voltage codes (ie AL6M-P3-② uses 12V AC/DC lamp).
3. LED Lamp is included and contains built-in current limiting resistor and reverse polarity protection diode. (no external resistor required)
4. To order sub-assembled, see page A2-23.
5. For accessories, see page A2-25.
6. For dimensions, see page A2-27.
7. For one piece pilot lights and/or dome lens pilot lights, see page A5-210.

Voltage Code

Voltage	Code
5V DC	1
6V AC/DC	2
12V AC/DC	3
24V AC/DC	4



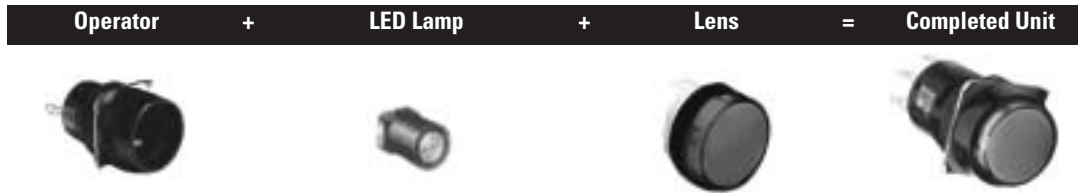



AL6 Pilot Lights (Sub-Assembled)



Part Numbers: Operators

Style	Part Number		
	Round	Square	Rectangular
AL6 Pilot Lights 	AL6M-P00	AL6Q-P00	AL6H-P00

Part Numbers: Lenses

Unit	Pilot Lights	
	Dustproof IP40	Oiltight IP65
Round	AL6M-LK1-② 	AL6M-LK3-② 
	AL6Q-LK1-② 	AL6Q-LK3-② 
Rectangular	AL6H-LK1-② 	AL6H-LK3-② 



- In place of ②, specify Lens Color Code from table below.
- Lenses which are rated IP65 include a waterproof rubber gasket.
- For accessories, see page A2-25.

②Lens/LED Color Code

Color	Code
Amber	A
Green	G
Red	R
Blue	S
White	W
Yellow	Y

Part Numbers: LED Lamps

























Appearance	Rated Voltage	Part Number
	5V DC	LATD-5②
	6V AC/DC	LATD-6②
	12V AC/DC	LATD-1②
	24V AC/DC	LATD-2②







In place of ②, specify LED Color Code from table at left.

AS6 Selector and Keylock Switches (Assembled)

Part Numbers: AS6 Selector Switches and Keylock Switches (2- & 3- Position)

Style	Function		Selector Switches	Keylock Switches	
Round Selector 	2-Position 90°	Maintained	 R	AS6M-2Y2P	AS6M-2KT2P①
		Spring Return Right	 R	AS6M-21Y2P	AS6M-21KT2PB
Round Keylock 	3-Position 45°	Maintained	 C R	AS6M-3Y2P	AS6M-3KT2P①
		Spring Return Right → Center	 C R	AS6M-31Y2P	AS6M-31KT2P①
		Spring Return Left → Center	 C R	AS6M-32Y2P	AS6M-32KT2P①
		2-Way Return → Center	 C R	AS6M-33Y2P	AS6M-33KT2PD
Square Selector 	2-Position 90°	Maintained	 R	AS6Q-2Y2P	AS6Q-2KT2P①
		Spring Return to Right	 R	AS6Q-21Y2P	AS6Q-21KT2PB
Square Keylock 	3-Position 45°	Maintained	 C R	AS6Q-3Y2P	AS6Q-3KT2P①
		Spring Return Right → Center	 C R	AS6Q-31Y2P	AS6Q-31KT2P①
		Spring Return Left → Center	 C R	AS6Q-32Y2P	AS6Q-32KT2P①
		2-Way Return → Center	 C R	AS6Q-33Y2P	AS6Q-33KT2PD
Rectangular Selector 	2-Position 90°	Maintained	 R	AS6H-2Y2P	AS6H-2KT2P①
		Spring Return Right	 R	AS6H-21Y2P	AS6H-21KT2PB
Rectangular Keylock 	3-Position 45°	Maintained	 C R	AS6H-3Y2P	AS6H-3KT2P①
		Spring Return Right → Center	 C R	AS6H-31Y2P	AS6H-31KT2P①
		Spring Return Left → Center	 C R	AS6H-32Y2P	AS6H-32KT2P①
		2-Way Return → Center	 C R	AS6H-33Y2P	AS6H-33KT2PD

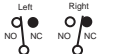
Contact Operations (for all selectors)

Contacts	Operator Position and Contact Operation	
2-pos. (DPDT)	Left	
	Right	
3-pos. (DPDT)	Left	
	Center	
	Right	

① Key Retention Codes

Code	Description
A	Key not retained in any position (removable in all positions)
B	Key retained in right position only
C	Key retained in left position only
D	Key retained in left and right (3 position only)
E	Key retained in center only (3 position only)
G	Key retained right and center (3 position only)
H	Key retained left and center (3 position only)















- For more information on these options, contact your IDEC representative.
- Key cannot be removed in a spring return position.



- In place of ①, specify Key Retention Code. See table on right.
- All models are IP65 and DPDT.
- Available as assembled units only.
- For accessories, see page A2-25.
- For dimensions, see page A2-27.

Accessories — A Series: 16mm

Appearance		Description	Used With	Part Number
Locking Ring Wrench		Made of metal. Used for tightening plastic locking ring during installation. Tightening torque should not exceed 3kgf-cm	Ø 5/8" (16mm) units	MT-001
			Ø 31/64" (12mm) AP2M units	MT-002
			Ø 13/32" (10mm) AP1M units	MT-003
Lens Removal Tool		Made of metal. Used for removing lens or button from the housing	All pushbuttons and pilot lights	MT-101
Lamp Holder Tool		Made of rubber. Used for removing and replacing LED lamps in illuminated units	All illuminated pushbuttons and pilot lights	OR-77
Switch Guard		Prevents inadvertent switch operation. IP40 dust-tight rated. 90 degrees opening maintained	Round/Square	AL-K6
			Rectangular	AL-KH6
		Prevents inadvertent switch operation. IP65 oiltight rated 180 degrees opening, spring return	Round/Square	AL-K6SP
			Rectangular	AL-KH6SP
Terminal Cover		Made of translucent nylon. Fits over and shields the terminals	All 5/8" (16mm) units	AL-V6
Dust Cover		Fits over the lens or button to provide protection from dust. (not applicable for oversize lenses or buttons)	All round units	AL-D6
			All square units	AL-DQ6
			All rectangular units	AL-DH6
Adaptor Socket		Plug-on terminal adaptor with solder terminal	All 5/8" (16mm) units	AL-C6
		Plug-on terminal adaptor with PCB terminal		AL-C6V
Mounting Hole Plug		Fills unused panel cutouts. Made of nitrile rubber. Push-in installation from front of panel. IP65 (oiltight) rated.	Rubber	AL-B6
		Fills unused panel cutouts. Made of aluminum. Screw-on locking ring from inside of panel. IP65 (oiltight) rated.	Aluminum	AL-BM6
Replacement LED Lamps		LED with built in current limiting resistor (with all illuminated assemblies).	5V DC	LATD-5②
			6V AC/DC	LATD-6②
			12V AC/DC	LATD-1②
			24V AC/DC	LATD-2②
Replacement Locking Ring		Fastens operators to panel (included with all operators).	All switches & pilot lights	HA9Z-LN
Anti-Rotation Ring		Prevents rotation of switches in panel (included with all operators).	All switches & pilot lights	AL6-LP
Replacement Engraving Inserts		Engraving plates to allow legends underneath translucent lenses (included with all lenses).	Round standard	AL6M-W
			Square standard	AL6Q-W
			Rectangular standard	AL6H-W
			Round oversize	AL6M-MW
			Square/rectangular oversize	AL6Q-QW
Replacement Keys		Pair of keys (#132). All key switches use same standard key.	All key selectors	AS6-SK

A2 Switches & Pilot Devices



- In place of ② specify color code. A=Amber, W=White, G=Green, Y=Yellow, R=Red, S=Blue.
- LEDs include built-in current limiting resistor and reverse polarity protection diode.

Schematics — A Series: 5/8" (16mm)

A2
Switches & Pilot Devices

Terminal Arrangement (Top View)

Illuminated Pushbuttons

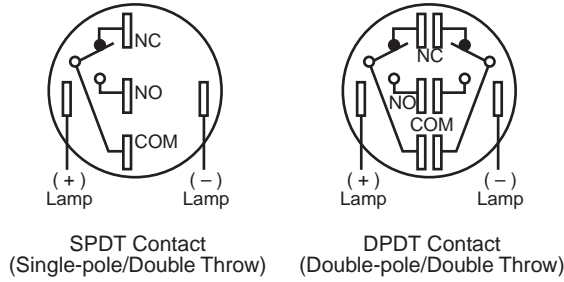

Non-illuminated Pushbuttons and Selector Switches

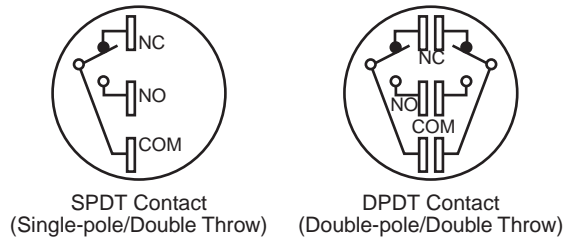

IDEC's Superbright LED

Internal Circuit

LATD-1,-2,-6 (GS)

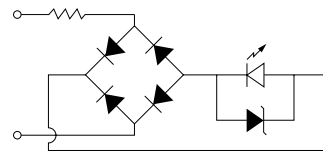

- LED Chip
- Protective Diode
- Zener Diode

LATD-5 (ARWY)



LATD-1,-2,-6 (ARWY)

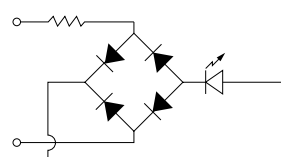

LATD-5 (GS)

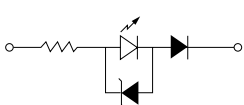

Dimensions — A Series: 5/8" (16mm)

Pushbuttons, Ø 5/8" (16mm)

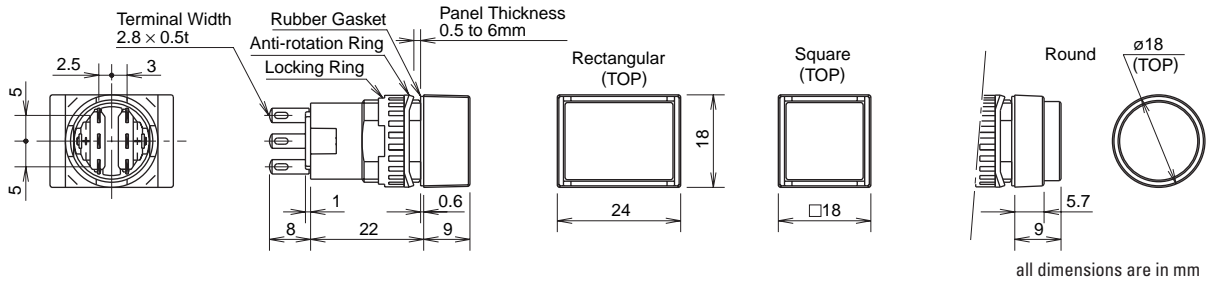

Large Size Lens

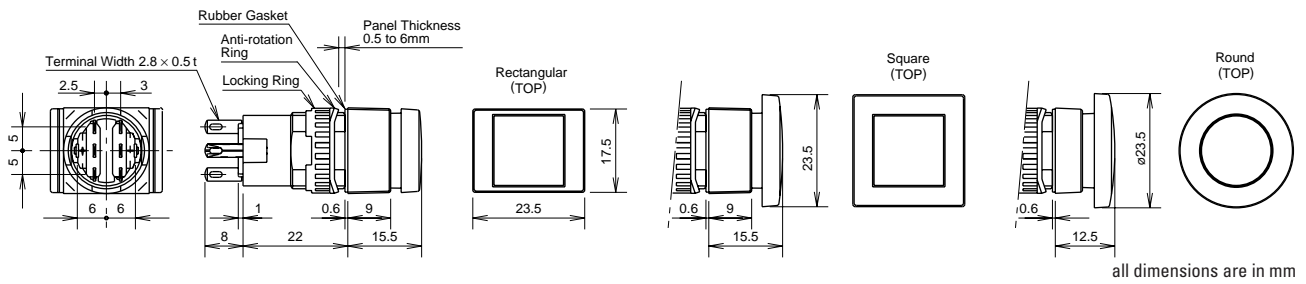

Selector Switches, Ø 5/8" (16mm)

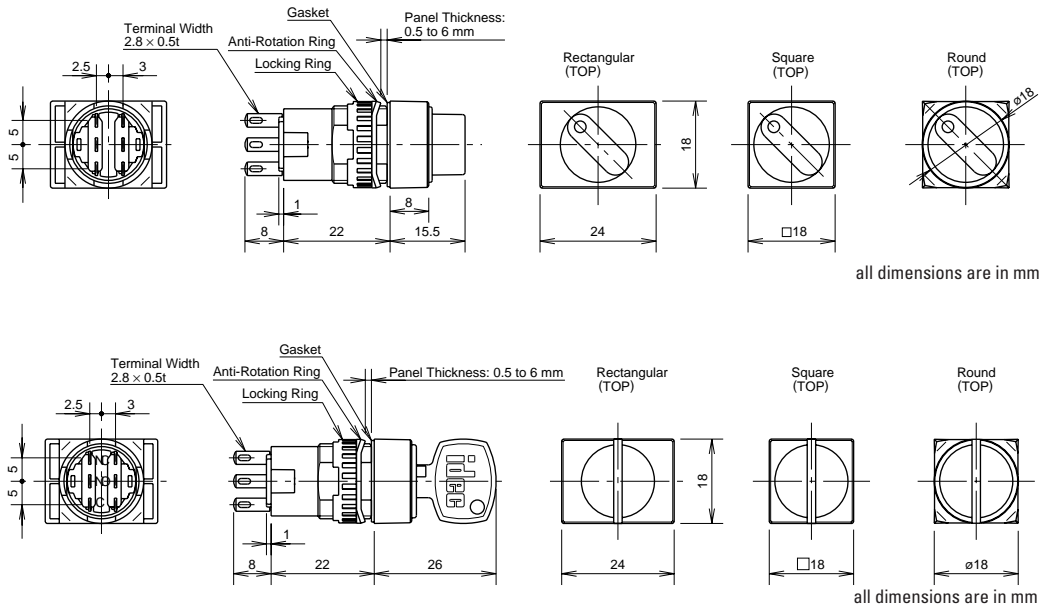

Dimensions con't

Switches & Pilot Devices

A2

Switch Guard, Ø 5/8" (16mm)

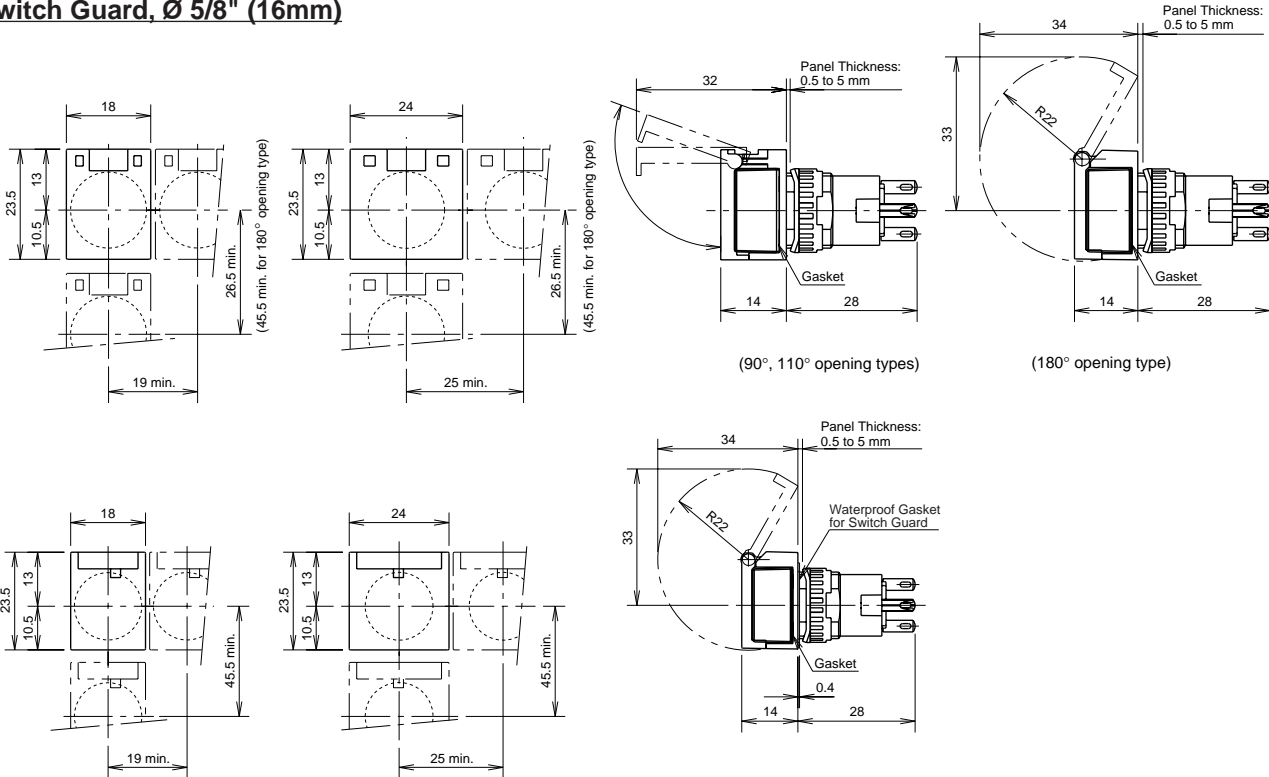

Terminal Sockets

AL-C6, 5/8" (16mm), Solder

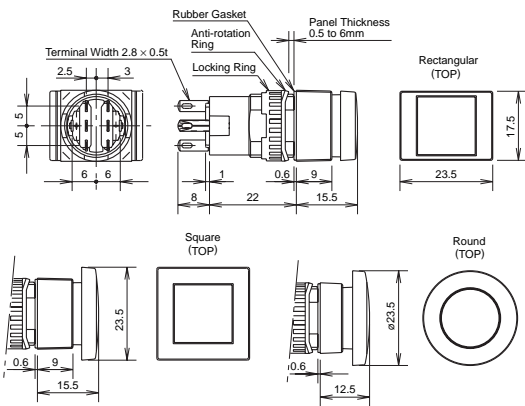

Dust Covers

AL-D6, Round

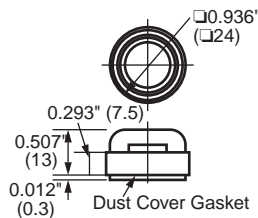

AL-DQ6, Square

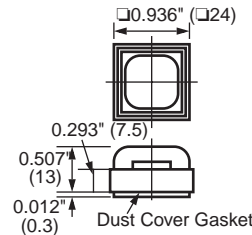

AL-DH6, Rectangular

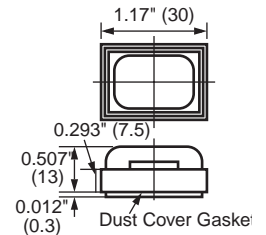

AL-C6V, Ø 5/8" (16mm), PCB

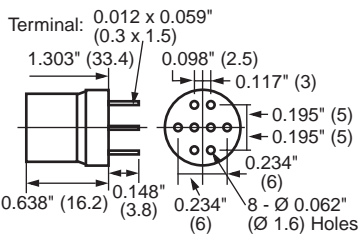

Panel Cut-Outs For Units w/Dust Cover

Round/Square

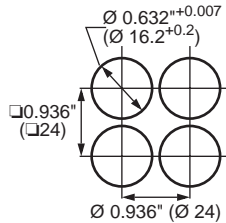

Rectangular

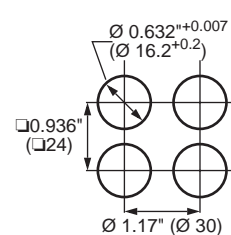

Dimensions con't

Marking Plates for Pushbuttons with Standard Size Lens

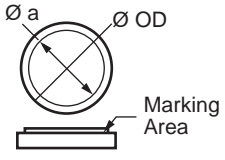
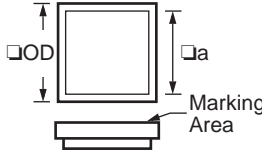
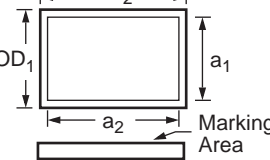
Style	Round—AL6M-W	Square—AL6Q-W	Rectangular—AL6H-W
Dimensions			
Ø 5/8" (16mm)			
Outside (OD)	Ø 0.538" (13.8mm)	□0.538" (13.8mm)	0.538" x 0.772" (13.8 x 19.8mm)
Marking Area (a)	Ø 0.468" (12mm)	□0.468" (12mm)	0.468" x 0.702" (12 x 18mm)



Engraving must be made on the engraving area within 0.02" (0.5mm) deep.

Marking Plates for Pushbutton with Oversize Lens

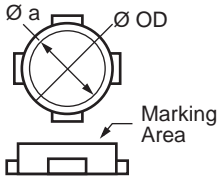
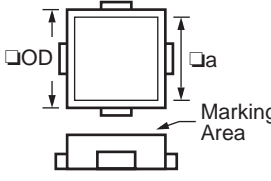
Style	Round—AL6M-MW	Square/Rectangular—AL6Q-QW
Dimensions		
Outside (OD)	Ø 0.491" (12.6mm)	□0.491" (12.6mm)
Marking Area (a)	Ø 0.429" (11mm)	□0.429" (11mm)

Replacing Lens and Marking Plate

Removal

Remove the lens holder assembly (lens, marking plate and holder) from the operator by holding the color lens recesses with the lens removal tool (Part No.MT-101) and pulling out. Remove marking plate by pushing the color lens from the rear to disengage the latches. Marking plate must be engraved on the side as shown in the figure on the right.

Installation

For illuminated and non-illuminated pushbuttons:

1. Insert marking plate inside lens in correct direction.
(For non-illuminated, install marking plate when replacing button).
2. Press color lens on to lens holder to engage latches.
3. Insert lens holder into housing in correct direction.



Do not loosen spring on illuminated pushbutton units (except on pilot light units). The marking plate must be engraved on the front side as shown above.

Ø 5/8" (16mm)

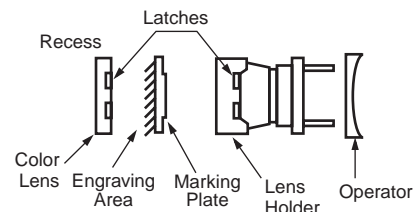

L6 Series — Miniature Switches and Pilot Devices

Key features of the 5/8" L6 Series include:

- 5/8" (16mm) mounting holes
- Locking lever removable contact blocks
- Solder terminal or PCB terminal options
- Available assembled or as sub-components
- Worldwide approvals
- Incandescent or LED illumination
- Snap action contacts

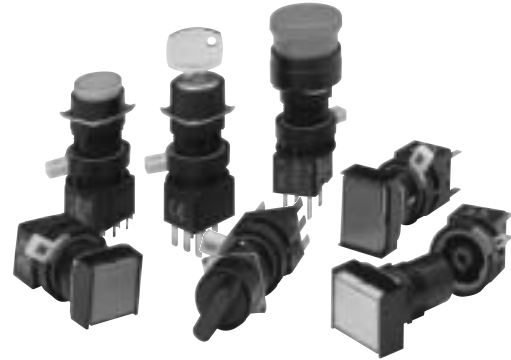

A2

Switches & Pilot Devices



UL Recognized
File No. E55996



CSA Certified
File No. LR21451











Registration No. R9551089 (E-stops)
Registration No. J9551458 (all other switches)
Registration No. J9650511 (Pilot Lights)

Contact Ratings	Conforming to Standards	EN60947-1, EN60947-5-1, VDE0660-200, UL508, CSA C22-2 NO.14						
	Operating Temperature	Operation: -25 to +55°C (without freezing), 45 to 85% rh Storage: -30 to +80°C (without freezing)						
	Vibration Resistance	5 to 55Hz, 1.0 peak-peak amplitude max						
	Shock Resistance	Operating limit: 100 m/sec ² (approximately 10G) Damage limit: 1000 m/sec ² (approximately 100G)						
	Mechanical Life	Momentary pushbuttons 2,000,000 operations minimum All others: 250,000 operations minimum						
	Degree of Protection	IP65 (conforming to IEC 60529)						
	Dielectric Strength	Switch unit: between live and ground: 2500 volt AC, 1 minute between terminals of different poles: 2500 volt AC, 1 minute between terminals of same pole: 1000 volt AC, 1 minute Illumination unit: between live part and ground: 2500 volt AC, 1 minute						
	Insulation Resistance	100 MΩ minimum (using 500V DC megger)						
	Rated Insulation Voltage	250 V AC/DC						
	Rated Thermal Current	Gold Contacts (pcb): 3A Silver Contacts (solder): 5A						
	Contact Resistance	50 Ω maximum initial value						
	Rated Operating Current		Silver Contacts (Solder Terminals)				Gold Clad Contacts (PCB terminals)	
			30V	125V	250V		30V	125V
	AC resistive	-	3A	2A	AC inductive	-	0.1A	
	AC inductive	-	2A	1.5A	DC resistive	0.1A	-	
	DC resistive	2A	0.4A	-	DC inductive	-	-	
	DC inductive	1A	0.2A	-				
Minimum Recommended Load (reference value for silver contacts)	5 VAC/DC, 1mA							
Terminal Style	0.110" Solder Tab /PCB							
Contact Form	Snap Action, Double Throw							
Contact Material	Solder Tab: Pure Silver /PCB thermal Gold Plated Silver							
Electrical Life (at full load)	Momentary pushbuttons: 100,000 operations minimum (1800 operations / hour) All others: 100,000 operations minimum (1200 operations / hour)							
Lamp Ratings	Lamp Current Draw	5V DC LED: 8mA		6V incandescent: 100 mA				
		6V LED: 7mA		12V incandescent: 50 mA				
		12V LED: 8mA		24V incandescent: 25 mA				
	Lamp Life	Incandescent: 2000 hours./LED: 50,000 hours. (on pure DC, half-life intensity)						
Buzzer Ratings	Frequency	2 khz ± 500 HZ						
	Amplitude	80db @ 0.1m (at rated voltage)						
	Operating Voltage	6V AC/DC or 12 - 24V AC/DC ± 10%						
	Adjustable Cycle	55 to 600 cycles per minute						
	Current Draw	DC: 7mA AC: 20mA						
	Life	1000 hrs. minimum						
	Insulation Voltage	60V AC/DC						
Operating Temperature	-20 to 55 C (no freezing), 45 to 85% rh							

Non-Illuminated Pushbuttons (Assembled)

Part Numbers: Non-Illuminated Pushbuttons

Style	Operation	Contact	Terminal Style	
			Solder Tab	PCB
Round 	Momentary	SPDT DPDT	LA1B-M1C5-① LA1B-M1C6-①	LA1B-M1C1V-① LA1B-M1C2V-①
	Maintained	SPDT DPDT	LA1B-A1C5-① LA1B-A1C6-①	LA1B-A1C1V-① LA1B-A1C2V-①
Square 	Momentary	SPDT DPDT	LA2B-M1C5-① LA2B-M1C6-①	LA2B-M1C1V-① LA2B-M1C2V-①
	Maintained	SPDT DPDT	LA2B-A1C5-① LA2B-A1C6-①	LA2B-A1C1V-① LA2B-A1C2V-①
Rectangular 	Momentary	SPDT DPDT	LA3B-M1C5-① LA3B-M1C6-①	LA3B-M1C1V-① LA3B-M1C2V-①
	Maintained	SPDT DPDT	LA3B-A1C5-① LA3B-A1C6-①	LA3B-A1C1V-① LA3B-A1C2V-①
Oversize Round Flush 	Momentary	SPDT DPDT	HA1B-M1C5-① HA1B-M1C6-①	HA1B-M1C1V-① HA1B-M1C2V-①
	Maintained	SPDT DPDT	HA1B-A1C5-① HA1B-A1C6-①	HA1B-A1C1V-① HA1B-A1C2V-①
Oversize Round Extended 	Momentary	SPDT DPDT	HA1B-M2C5-① HA1B-M2C6-①	HA1B-M2C1V-① HA1B-M2C2V-①
	Maintained	SPDT DPDT	HA1B-A2C5-① HA1B-A2C6-①	HA1B-A2C1V-① HA1B-A2C2V-①
Oversize Square Flush 	Momentary	SPDT DPDT	HA2B-M1C5-① HA2B-M1C6-①	HA2B-M1C1V-① HA2B-M1C2V-①
	Maintained	SPDT DPDT	HA2B-A1C5-① HA2B-A1C6-①	HA2B-A1C1V-① HA2B-A1C2V-①
Oversize Square Extended 	Momentary	SPDT DPDT	HA2B-M2C5-① HA2B-M2C6-①	HA2B-M2C1V-① HA2B-M2C2V-①
	Maintained	SPDT DPDT	HA2B-A2C5-① HA2B-A2C6-①	HA2B-A2C1V-① HA2B-A2C2V-①
Mushroom 	Momentary	SPDT DPDT	HA1B-M3C5-① HA1B-M3C6-①	HA1B-M3C1V-① HA1B-M3C2V-①
	Maintained	SPDT DPDT	HA1B-A3C5-① HA1B-A3C6-①	HA1B-A3C1V-① HA1B-A3C2V-①

Button Color Codes

Color	Code
Black	B
Green	G
Red	R
Blue	S
White	W
Yellow	Y

A2

Switches & Pilot Devices



- In place of ① specify Button Color Code from table on right.
- Illuminated (translucent) style lenses also available, specify as such: instead of LA1B-M1C5-① use LA1B-M1C5L-② in place of ② specify Lens Color Code from next page.)
- PCB terminal models also available with silver contacts (change "1" or "2" to "5" or "6" respectively, ie LA1B-M1C1V-① becomes LA1B-M1C5V-①).

Non-Illuminated Pushbuttons (Sub-Assembled)

Contact + Safety Lever Lock + Operator + Button = Complete Part



A2

Switches & Pilot Devices

Part Numbers: Operators

Style	Momentary	Maintained
Round 	LA1L-M0	LA1L-A0
Square 	LA2L-M0	LA2L-A0
Rectangular 	LA3L-M0	LA3L-A0
Oversize Round 	HA1B-M0	HA1B-A0
Oversize Square 	HA2B-M0	HA2B-A0
Mushroom 	HA1B-M0L	HA1B-A0L

Part Numbers: Buttons/Lenses

Style	Button	Lens
Round 	AB6M-BK2-①	AL6M-LK2-②
Square 	AB6Q-BK2-①	AL6Q-LK2-②
Rectangular 	AB6H-BK2-①	AL6H-LK2-②
Oversize Round Flush 	HA1A-B1-①	HA1A-L1-②*
Oversize Round Extended 	HA1A-B2-①	-
Oversize Square Flush 	HA2A-B1-①	HA2A-L1-②**
Oversize Square Extended 	HA2A-B2-①	-
Mushroom 	HA1A-B3-①	HA1A-L3-②

Part Numbers: Contacts

Appearance	Contacts	Terminal Style	
		Solder Tab	PCB
	Gold	SPDT DPDT	HA-C1 HA-C2 HA-C1V HA-C2V
	Silver	SPDT DPDT	HA-C5 HA-C6 HA-C5V HA-C6V

Part Number: Safety Lever Lock

Appearance	Part Number
	HA9Z-LS

① Button Color Code

Color	Code
Black	B
Green	G
Red	R
Blue	S
White	W
Yellow	Y

② Lens Color Code

Color	Code
Amber	A
Green	G
Red	R
Blue	S
Yellow	Y
White	W



- In place of ① specify Button Color Code from table on right.
- In place of ② specify Lens Color Code from table on right.
- *requires HA1L-M0 or HA1L-A0 operator instead of HA1B-M0 or HA1B-A0.
- **requires HA2L-M0 or HA2L-A0 instead of HA2B-M0 or HA2B-A0.

HA1B/HA1E E-Stop

Miniature Switches and Pilot Devices: 5/8" (16mm)

Key features of HA1B/HA1E Push lock Turn Reset include:

- PCB or Solder Terminals
- Quick Release Contact Blocks
- Positive Action Contacts
- 1 or 2 form B (SPST-NC) Contacts
- IP65 Protection
- 16mm Mounting Hole
- Tamper Proof Construction



A2

Switches & Pilot Devices

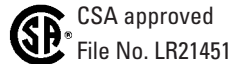

Specifications	Contact Ratings	24VDC/2A 120VAC/3A	
	Contact Form	1 or 2 form B (2-SPST-NC)	
	Termination	PCB or Solder Terminal	
	Contact Material	Silver	
	Applicable Standards	EN60947-5-1, UL-508, CSA 22.2. No. 14	
	Rated Insulation Voltage	250V	
	Degree of Protection	IP65, when mounted in an enclosure	
	Conditional Short-Circuit Current & Short-Circuit Protective Device	50 A (at 250V) 10A 250V Fuse, operation class aM according to IEC269-1 and IEC269-2	
	Positive Opening Operation	Positive opening travel	3.4mm
		Minimum force required to achieve positive opening operation of all break contacts.	10.3 N (2 form B contacts)
Maximum travel including travel beyond the minimum travel position		5.5mm	
Maximum frequency of actuation		1,200 operations/hour	
Pollution Degree	3		

Part Numbers: Nameplates

HAAV-Yellow Plastic

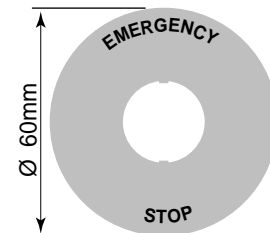

	Part Number
Blank	HAAV-0
Engraved Emergency Stop	HAAV-27

Part Numbers: Positive Action E-Stop

	Appearance	Operation	Contact	Terminal Style	
				Solder Tab	PCB
E-Stop		Pushlock/ Turn Reset	DPST(NC) (2 form B)	HA1B-V2E2R	HA1B-V2E2VR
			Short Body SPST-NC (1 form B) DPST-NC (2 form B)	HA1E-V2S1R HA1E-V2S2R	-

Button is non-removable, available in red and as complete assembled unit only.

Part Number: Buzzers (IP40)

	Appearance	Operating Voltage	Terminal Style	
			Solder/Tab	PCB
Buzzer-Rectangular		6V AC/DC ± 10%	LA3Z-1X2	LA3Z-1X2V
		12V to 24 AC/DC ± 10%	LA3Z-1X4	LA3Z-1X4V

Frequency: 2kHz ± 500 Hz
Amplitude: 80db at 0.1m
Beeping: Adjustable from steady tone to 600 beeps per minute.

Pilot Lights (Assembled)

Switches & Pilot Devices

A2

Part Numbers: Pilot Lights (LED)

Style	Voltage	Terminal Style	
		Solder Tab	PCB
Round 	24V AC/DC LED 24VAC/DC Incandescent	LA1P-1C04-② LA1P-1C07-②	LA1P-1C04V-② LA1P-1C07V-②
Square 	24V AC/DC LED 24V AC/DC Incandescent	LA2P-1C04-② LA2P-1C07-②	LA2P-1C04V-② LA2P-1C07V-②
Rectangle 	24V AC/DC LED 24V AC/DC Incandescent	LA3P-1C04-② LA3P-1C07-②	LA3P-1C04V-② LA3P-1C07V-②
Oversize Round 	24V AC/DC LED 24V AC/DC Incandescent	HA1P-1C04-② HA1P-1C07-②	HA1P-1C04V-② HA1P-1C07V-②
Oversize Square 	24V AC/DC LED 24V AC/DC Incandescent	HA2P-1C04-② HA2P-1C07-②	HA2P-1C04V-② HA2P-1C07V-②
Oversize Round Unibody 	24V AC/DC LED 24V AC/DC Incandescent	HA1P-14-② HA1P-17-②	-
Oversize Square Unibody 	24V AC/DC LED 24V AC/DC Incandescent	HA2P-14-② HA2P-17-②	-

② Lens/LED Color Codes

Color	Code
Amber	A
Green	G
Red	R
Blue	S
Yellow	Y
White	W

Voltage/Lamp Code

Voltage	Code
5V DC LED	1
6V AC/DC LED	2
12V AC/DC LED	3
24V AC/DC LED	4
120 V AC LED	8
6V AC/DC Incandescent	5
12V AC/DC Incandescent	6
24V AC/DC Incandescent	7



- In place of ② specify Lens/LED Color Code from table.
- Lamps also available in 5VDC, 6V AC/DC, 12V AC/DC or 120V AC, change "4" or "7" using Voltage/Lamp Codes (ie LA1P-1C03-② uses 12V AC/DC LED).

Pilot Lights (Sub-Assembled)

Terminals + Safety Lever Lock + Lamp Holder + Lamp + Operator + Lens = Completed Unit



A2

Switches & Pilot Devices

Part Numbers: Operators

Style	Part Number
Round	LA1P-0
Square	LA2P-0
Rectangular	LA3P-0
Oversize Round	HA1P-0
Oversize Square	HA2P-0
Oversize Round Unibody	HA1P-00
Oversize Square Unibody	HA2P-00

Part Numbers: Lenses

Style	Part Number
Round	AL6M-LK3-②
Square	AL6Q-LK3-②
Rectangular	AL6H-LK3-②
Oversize Round	HA1A-P1-②
Oversize Square	HA2A-P1-②

In place of ② specify lens color code.

Part Numbers: Lamps

Style	Voltage	Part Number
LED	5V DC	LFTD-5②
	6V AC/DC	LFTD-6②
	12V AC/DC	LFTD-1②
	24V AC/DC	LFTD-2②
	120 V AC	LFTD-H2②
Incandescent	6V AC/DC	LH-06
	12V AC/DC	LH-14
	24V AC/DC	LH-28

In place of ② specify LED color code from table below.

Part Numbers: Terminals

Appearance	Solder Tab	PCB
	HA-C00	HA-C00V

Not required for unibody models.

Part Number: Lamp Holder

Appearance	Part Number
	HA9Z-AH

Part Number: Safety Lever Lock

Appearance	Part Number
	HA9Z-LS

② Lens/LED Color Codes

Color	Code
Amber	A
Green	G
Red	R
Blue	S
Yellow	Y

Illuminated Pushbuttons (Assembled)

Part Numbers: Illuminated Pushbuttons

Style	Operation	Lamp Voltage	Contact	Terminal Style		
				Solder Tab	PCB	
 Round	Momentary	24V AC/DC LED	SPDT	LA1L-M1C54-②	LA1L-M1C14V-②	
		Incandescent	DPDT	LA1L-M1C64-②	LA1L-M1C24V-②	
	Maintained	24V AC/DC LED	SPDT	LA1L-A1C54-②	LA1L-A1C14V-②	
		Incandescent	DPDT	LA1L-A1C64-②	LA1L-A1C24V-②	
	 Square	Momentary	24V AC/DC LED	SPDT	LA2L-M1C54-②	LA2L-M1C14V-②
			Incandescent	DPDT	LA2L-M1C64-②	LA2L-M1C24V-②
Maintained		24V AC/DC LED	SPDT	LA2L-A1C54-②	LA2L-A1C14V-②	
		Incandescent	DPDT	LA2L-A1C64-②	LA2L-A1C24V-②	
 Rectangular		Momentary	24V AC/DC LED	SPDT	LA3L-M1C54-②	LA3L-M1C14V-②
			Incandescent	DPDT	LA3L-M1C64-②	LA3L-M1C24V-②
	Maintained	24V AC/DC LED	SPDT	LA3L-A1C54-②	LA3L-A1C14V-②	
		Incandescent	DPDT	LA3L-A1C64-②	LA3L-A1C24V-②	
	 Oversize Round	Momentary	24V AC/DC LED	SPDT	HA1L-M1C54-②	HA1L-M1C14V-②
			Incandescent	DPDT	HA1L-M1C64-②	HA1L-M1C24V-②
Maintained		24V AC/DC LED	SPDT	HA1L-A1C54-②	HA1L-A1C14V-②	
		Incandescent	DPDT	HA1L-A1C64-②	HA1L-A1C24V-②	
 Oversize Square		Momentary	24V AC/DC LED	SPDT	HA2L-M1C54-②	HA2L-M1C14V-②
			Incandescent	DPDT	HA2L-M1C64-②	HA2L-M1C24V-②
	Maintained	24V AC/DC LED	SPDT	HA2L-A1C54-②	HA2L-A1C14V-②	
		Incandescent	DPDT	HA2L-A1C64-②	HA2L-A1C24V-②	
	 Mushroom	Momentary	24V AC/DC LED	SPDT	HA1L-M3C54-②	HA1L-M3C14V-②
			Incandescent	DPDT	HA1L-M3C64-②	HA1L-M3C24V-②
Maintained		24V AC/DC LED	SPDT	HA1L-A3C54-②	HA1L-A3C14V-②	
		Incandescent	DPDT	HA1L-A3C64-②	HA1L-A3C24V-②	

② Lens Color Codes

Color	Code
Amber	A
Green	G
Red	R
Blue	S
Yellow	Y
White	W

Voltage/Lamp Code

Voltage	Code
5V DC LED	1
6V AC/DC LED	2
12V AC/DC LED	3
24V AC/DC LED	4
120V AC LED	8
6V AC/DC Incandescent	5
12V AC/DC Incandescent	6
24V AC/DC Incandescent	7



- In place of ② specify lens color code from table at right.
- Lamps also available in 5V DC, 6V AC/DC, 12 V AC/DC or 120V AC, change “4” or “7” using voltage/lamp codes (ie LA1P-1C03-② uses 12V AC/DC LED).
- PCB terminal models also available with silver contacts (change “1” or “2” to “5” or “6” respectively, ie LA1L-M1C14V-① becomes LA1L-M1C54V-①).

Illuminated Pushbuttons (Sub-Assembled)

A2

Switches & Pilot Devices

Contacts + Safety Lever Lock + Lamp Holder + Lamp + Operator + Lens = Completed Unit



Part Numbers: Operators

Style	Momentary	Maintained
Round 	LA1L-M0	LA1L-A0
Square 	LA2L-M0	LA2L-A0
Rectangular 	LA3L-M0	LA3L-A0
Oversize Round 	HA1L-M0	HA1L-A0
Oversize Square 	HA2L-M0	HA2L-A0
Mushroom 	HA1B-M0L	HA1B-A0L



Part Numbers: Lenses

Style	Part Number
Round 	AL6M-LK2-②
Square 	AL6Q-LK2-②
Rectangular 	AL6H-LK2-②
Oversize Round 	HA1A-L1-②
Oversize Square 	HA2A-L1-②
Mushroom 	HA1A-L3-②



In place of ② specify Lens Color Code from table.



Part Numbers: Lamps

Appearance	Voltage	Part Number
LED 	5V DC 6V AC/DC 12V AC/DC 24V AC/DC 120V AC	LFTD-5② LFTD-6② LFTD-1② LFTD-2② LFTD-H2②
Incandescent 	6V AC/DC 12V AC/DC 24V AC/DC	LH-06 LH-14 LH-28



In place of ② specify LED color code from table below.

Part Numbers: Contacts

Appearance	Contacts	Terminal Style	
		Solder Tab	PCB
	Gold SPDT DPDT	HA-C10 HA-C20	HA-C10V HA-C20V
	Silver SPDT DPDT	HA-C50 HA-C60	HA-C50V HA-C60V

Part Number: Lamp Holder

Appearance	Part Number
	HA9Z-AH

Part Number: Safety Lever Lock

Appearance	Part Number
	HA9Z-LS

② Lens/LED Color Codes

Color	Code
Amber	A
Green	G
Red	R
Blue	S
Yellow	Y
White	W

Selector Switches (Assembled)

Part Numbers: Selector Switches

A2

Switches & Pilot Devices

Style	Position	Position Diagram	Contact	Terminal Style	
				Solder Tab	PCB
Round 	90° 2-Position	Maintained		DPDT	LA1S-2C6 LA1S-2C2V
		Spring return from right		DPDT	LA1S-21C6 LA1S-21C2V
	45° 3-Position	Maintained		DPDT	LA1S-3C6 LA1S-3C2V
		Spring return from right		DPDT	LA1S-31C6 LA1S-31C2V
		Spring return from left		DPDT	LA1S-32C6 LA1S-32C2V
		2-Way spring return		DPDT	LA1S-33C6 LA1S-33C2V
Square 	90° 2-Position	Maintained		DPDT	LA2S-2C6 LA2S-2C2V
		Spring return from right		DPDT	LA2S-21C6 LA2S-21C2V
	45° 3-Position	Maintained		DPDT	LA2S-3C6 LA2S-3C2V
		Spring return from right		DPDT	LA2S-31C6 LA2S-31C2V
		Spring return from left		DPDT	LA2S-32C6 LA2S-32C2V
		2-Way spring Return		DPDT	LA2S-33C6 LA2S-33C2V
Rectangular 	90° 2-Position	Maintained		DPDT	LA3S-2C6 LA3S-2C2V
		Spring return from right		DPDT	LA3S-21C6 LA3S-21C2V
	45° 3-Position	Maintained		DPDT	LA3S-3C6 LA3S-3C2V
		Spring return from right		DPDT	LA3S-31C6 LA3S-31C2V
		Spring return from left		DPDT	LA3S-32C6 LA3S-32C2V
		2-Way spring Return		DPDT	LA3S-33C6 LA3S-33C2V
Oversize Round 	90° 2-Position	Maintained		DPDT	HA1S-2C6 HA1S-2C2V
		Spring return from right		DPDT	HA1S-21C6 HA1S-21C2V
	45° 3-Position	Maintained		DPDT	HA1S-3C6 HA1S-3C2V
		Spring return from right		DPDT	HA1S-31C6 HA1S-31C2V
		Spring return from left		DPDT	HA1S-32C6 HA1S-32C2V
		2-Way spring Return		DPDT	HA1S-33C6 HA1S-33C2V

Contact Operations (for all selectors)

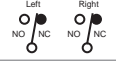
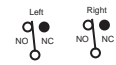
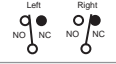
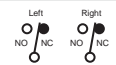
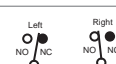
Contacts	Operator Position and Contact Operation	
2-pos. (DPDT)	Left	
	Right	
3-pos. (DPDT)	Left	
	Center	
	Right	



As viewed from front of switch.



1. All assembled selector switches use DPDT contacts.
2. For SPDT contacts see sub-components on next page.
3. PCB terminal models also available with silver contacts (change "1" or "2" to "5" or "6" respectively, ie LA1S-21C2V becomes LA1S-21C6V).

Selector Switches (Sub-Assembled)

Contacts + Safety Lever Lock + Operator = Complete Part





A2

Switches & Pilot Devices

Part Numbers: Operators

Style	Position	Function	Part Number
 Round	2	Maintained Spring from right	LA1S-2Y LA1S-21Y
	3	Maintained Spring from right Spring from left Spring from both	LA1S-3Y LA1S-31Y LA1S-32Y LA1S-33Y
 Square	2	Maintained Spring from right	LA2S-2Y LA2S-21Y
	3	Maintained Spring from right Spring from left Spring from both	LA2S-3Y LA2S-31Y LA2S-32Y LA2S-33Y
 Rectangular	2	Maintained Spring from right	LA3S-2Y LA3S-21Y
	3	Maintained Spring from right Spring from left Spring from both	LA3S-3Y LA3S-31Y LA3S-32Y LA3S-33Y
 Oversize Round	2	Maintained Spring from right	HA1S-2Y HA1S-21Y
	3	Maintained Spring from right Spring from left Spring from both	HA1S-3Y HA1S-31Y HA1S-32Y HA1S-33Y

Part Numbers: Contacts

Appearance		Contacts	Terminal Style	
			Solder Tab	PCB
 Gold	 Silver	SPDT DPDT	HA-C1 HA-C2	HA-C1V HA-C2V
		SPDT DPDT	HA-C5 HA-C6	HA-C5V HA-C6V



1. All assembled switches listed on previous page use DPDT contacts.
2. SPDT Contacts for use on 2 position selector switch only

Part Number: Safety Lever Lock

Appearance	Part Number
	HA9Z-LS

Key Switches (Assembled)

Part Numbers: Key Switches

Style		Operation	Contacts	Terminal Type		
				Solder Tab	PCB	
Round	90° 2-Position	Maintained		DPDT	LA1K-2C6③	LA1K-2C2V③
		Spring return from right		DPDT	LA1K-21C6B	LA1K-21C2VB
	45° 3-Position	Maintained		DPDT	LA1K-3C6③	LA1K-3C2V③
		Spring return from right		DPDT	LA1K-31C6③	LA1K-31C2V③
		Spring return from left		DPDT	LA1K-32C6③	LA1K-32C2V③
		2-Way spring return		DPDT	LA1K-33C6D	LA1K-33C2VD
Square	90° 2-Position	Maintained		DPDT	LA2K-2C6③	LA2K-2C2V③
		Spring return from right		DPDT	LA2K-21C6B	LA2K-21C2VB
	45° 3-Position	Maintained		DPDT	LA2K-3C6③	LA2K-3C2V③
		Spring return from right		DPDT	LA2K-31C6③	LA2K-31C2V③
		Spring return from left		DPDT	LA2K-32C6③	LA2K-32C2V③
		2-Way spring return		DPDT	LA2K-33C6D	LA2K-33C2VD
Rectangular	90° 2-Position	Maintained		DPDT	LA3K-2C6③	LA3K-2C2V③
		Spring return from right		DPDT	LA3K-21C6B	LA3K-21C2VB
	45° 3-Position	Maintained		DPDT	LA3K-3C6③	LA3K-3C2V③
		Spring return from right		DPDT	LA3K-31C6③	LA3K-31C2V③
		Spring return from left		DPDT	LA3K-32C6③	LA3K-32C2V③
		2-Way spring return		DPDT	LA3K-33C6D	LA3K-33C2VD
Oversize Round	90° 2-Position	Maintained		DPDT	HA1K-2C6③	HA1K-2C2V③
		Spring return from right		DPDT	HA1K-21C6B	HA1K-21C2VB
	45° 3-Position	Maintained		DPDT	HA1K-3C6③	HA1K-3C2V③
		Spring return from right		DPDT	HA1K-31C6③	HA1K-31C2V③
		Spring return from left		DPDT	HA1K-32C6③	HA1K-32C2V③
		2-Way spring return		DPDT	HA1K-33C6D	HA1K-33C2VD

Contact Operations (for all selectors)

Contacts	Operator Position and Contact Operation	
2-pos. (DPDT)	Left	
	Right	
3-pos. (DPDT)	Left	
	Center	
	Right	



As viewed from front of switch.

③ Key Retention Option Codes

Code	Description
A	Key not retained in any position (removable in all positions)
B	Key retained in right position only
C	Key retained in left position only
D	Key retained in left and right (3 position only)
E	Key retained in center only (3 position only)
G	Key retained right and center (3 position only)
H	Key retained left and center (3 position only)



Key cannot be removed from a spring-return position.



- In place of ③ specify Key Retention Code from next page.
- All assembled key switches have DPDT contacts. For SPDT see sub-assembled on next page.
- PCB terminal models also available with silver contacts (change "1" or "2" to "5" or "6" respectively, ie LA1K-2C2V③ becomes LA1K-2C6V③).

Switches & Pilot Devices

A2







Key Switches (Sub-Assembled)



A2

Switches & Pilot Devices

Part Numbers: Operators

Style	Positions	Operation	Part Number
 Round	2	Maintained Spring from right	LA1K-2 ^③ LA1K-21B
	3	Maintained Spring from right Spring from left Spring from both	LA1K-3 ^③ LA1K-31 ^③ LA1K-32 ^③ LA1K-33D
 Square	2	Maintained Spring from right	LA2K-2 ^③ LA2K-21B
	3	Maintained Spring from right Spring from left Spring from both	LA2K-3 ^③ LA2K-31 ^③ LA2K-32 ^③ LA2K-33D
 Rectangular	2	Maintained Spring from right	LA3K-2 ^③ LA3K-21B
	3	Maintained Spring from right Spring from left Spring from both	LA3K-3 ^③ LA3K-31 ^③ LA3K-32 ^③ LA3K-33D
 Oversize Round	2	Maintained Spring from right	HA1K-2 ^③ HA1K-21B
	3	Maintained Spring from right Spring from left Spring from both	HA1K-3 ^③ HA1K-31 ^③ HA1K-32 ^③ HA1K-33D



- In place of ^③ specify key removable code from table on right.
- Operator includes two keys.

Part Numbers: Contacts

Appearance	Contacts	Terminal Style	
		Solder Tab	PCB
	Gold	SPDT DPDT	HA-C1 HA-C2 HA-C1V HA-C2V
	Silver	SPDT DPDT	HA-C5 HA-C6 HA-C5V HA-C6V



- All assembled selectors listed on previous page use DPDT contacts.
- SPDT contacts are for use on 2 position key switches only.

Part Number: Safety Lever Lock

Appearance	Part Number
	HA9Z-LS

③ Key Retention Option Codes





























Code	Description
A	Key not retained in any position (removable in all positions)
B	Key retained in right position only
C	Key retained in left position only
D	Key retained in left and right (3 position only)
E	Key retained in center only (3 position only)
G	Key retained right and center (3 position only)
H	Key retained left and center (3 position only)



Key cannot be removed from a spring-return position.

Illuminated Selector Switches

Part Numbers: Illuminated Selectors Switches

Style			Contact	Voltage	Terminal Style		
					Solder Tab	PCB	
Round 	90° 2-Position	Maintained		DPDT	24V LED 24V Incand.	LA1F-2C64-② LA1F-2C67-②	LA1F-2C24V-② LA1F-2C27V-②
		Spring return from right		DPDT	24V LED 24V Incand.	LA1F-21C64-② LA1F-21C67-②	LA1F-21C24V-② LA1F-21C27V-②
	45° 3-Position	Maintained		DPDT	24V LED 24V Incand.	LA1F-3C64-② LA1F-3C67-②	LA1F-3C24V-② LA1F-3C27V-②
		Spring return from right		DPDT	24V LED 24V Incand.	LA1F-31C64-② LA1F-31C67-②	LA1F-31C24V-② LA1F-31C27V-②
		Spring return from left		DPDT	24V LED 24V Incand.	LA1F-32C64-② LA1F-32C67-②	LA1F-32C24V-② LA1F-32C27V-②
		2-Way spring return		DPDT	24V LED 24V Incand.	LA1F-33C64-② LA1F-33C67-②	LA1F-33C24V-② LA1F-33C27V-②
Square 	90° 2-Position	Maintained		DPDT	24V LED 24V Incand.	LA2F-2C64-② LA2F-2C67-②	LA2F-2C24V-② LA2F-2C27V-②
		Spring return from right		DPDT	24V LED 24V Incand.	LA2F-21C64-② LA2F-21C67-②	LA2F-21C24V-② LA2F-21C27V-②
	45° 3-Position	Maintained		DPDT	24V LED 24V Incand.	LA2F-3C64-② LA2F-3C67-②	LA2F-3C24V-② LA2F-3C27V-②
		Spring return from right		DPDT	24V LED 24V Incand.	LA2F-31C64-② LA2F-31C67-②	LA2F-31C24V-② LA2F-31C27V-②
		Spring return from left		DPDT	24V LED 24V Incand.	LA2F-32C64-② LA2F-32C67-②	LA2F-32C24V-② LA2F-32C27V-②
		2-Way spring return		DPDT	24V LED 24V Incand.	LA2F-33C64-② LA2F-33C67-②	LA2F-33C24V-② LA2F-33C27V-②
Rectangular 	90° 2-Position	Maintained		DPDT	24V LED 24V Incand.	LA3F-2C64-② LA3F-2C67-②	LA3F-2C24V-② LA3F-2C27V-②
		Spring return from right		DPDT	24V LED 24V Incand.	LA3F-21C64-② LA3F-21C67-②	LA3F-21C24V-② LA3F-21C27V-②
	45° 3-Position	Maintained		DPDT	24V LED 24V Incand.	LA3F-3C64-② LA3F-3C67-②	LA3F-3C24V-② LA3F-3C27V-②
		Spring return from right		DPDT	24V LED 24V Incand.	LA3F-31C64-② LA3F-31C67-②	LA3F-31C24V-② LA3F-31C27V-②
		Spring return from left		DPDT	24V LED 24V Incand.	LA3F-32C64-② LA3F-32C67-②	LA3F-32C24V-② LA3F-32C27V-②
		2-Way spring return		DPDT	24V LED 24V Incand.	LA3F-33C64-② LA3F-33C67-②	LA3F-33C24V-② LA3F-33C27V-②
Oversize Round 	90° 2-Position	Maintained		DPDT	24V LED 24V Incand.	HA1F-2C64-② HA1F-2C67-②	HA1F-2C24V-② HA1F-2C27V-②
		Spring return from right		DPDT	24V LED 24V Incand.	HA1F-21C64-② HA1F-21C67-②	HA1F-21C24V-② HA1F-21C27V-②
	45° 3-Position	Maintained		DPDT	24V LED 24V Incand.	HA1F-3C64-② HA1F-3C67-②	HA1F-3C24V-② HA1F-3C27V-②
		Spring return from right		DPDT	24V LED 24V Incand.	HA1F-31C64-② HA1F-31C67-②	HA1F-31C24V-② HA1F-31C27V-②
		Spring return from left		DPDT	24V LED 24V Incand.	HA1F-32C64-② HA1F-32C67-②	HA1F-32C24V-② HA1F-32C27V-②
		2-Way spring return		DPDT	24V LED 24V Incand.	HA1F-33C64-② HA1F-33C67-②	HA1F-33C24V-② HA1F-33C27V-②

Contact Operations (for all selectors)

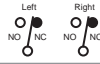
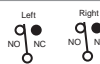
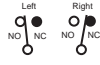
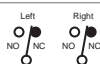
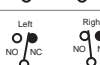
Contacts	Operator Position and Contact Operation	
2-pos. (DPDT)	Left	
	Right	
3-pos. (DPDT)	Left	
	Center	
	Right	



As viewed from front of switch.

② Lens/LED Color Code

Color	Code
Amber	A
Green	G
Red	R
Blue	S
Yellow	Y
White	W

Voltage/Lamp Code

Voltage	Code
5V DC LED	1
6V AC/DC LED	2
12V AC/DC LED	3
24V AC/DC LED	4
120V AC LED	8
6V AC/DC Incandescent	5
12V AC/DC Incandescent	6
24V AC/DC Incandescent	7



- In place of ② specify Lens/LED Color Code from table above.
- Lamps also available in 5V DC, 6V AC/DC or 12 V AC/DC, change "4" or "7" using voltage/lamp codes (ie LA1F-2C63-② uses 12V AC/DC LED).
- All switches listed have DPDT contacts. For SPDT see sub-assembled on next page.
- PCB terminal models also available with silver contacts (change "1" or "2" to "5" or "6" respectively, ie LA1F-2C24V-② becomes LA1F-2C64V-②).

Illuminated Selector Switches (Sub-Assembled)





Contacts + Safety lever lock + Lamp Holder + Lamp + Operator + Lens/Handle = Completed Unit

A2



Switches & Pilot Devices



Part Numbers: Operators

Style	Positions	Function	Part Number
Round 	2	Maintained Spring from right	LA1F-20 LA1F-210
	3	Maintained Spring from right Spring from left Spring from both	LA1F-30 LA1F-310 LA1F-320 LA1F-330
	2	Maintained Spring from right	LA2F-20 LA2F-210
Square 	3	Maintained Spring from right Spring from left Spring from both	LA2F-30 LA2F-310 LA2F-320 LA2F-330
	2	Maintained Spring from right	LA3F-20 LA3F-210
	3	Maintained Spring from right Spring from left Spring from both	LA3F-30 LA3F-310 LA3F-320 LA3F-330
Rectangular 	2	Maintained Spring from right	HA1F-20 HA1F-210
	3	Maintained Spring from right Spring from left Spring from both	HA1F-30 HA1F-310 HA1F-320 HA1F-330
Oversize Round 	2	Maintained Spring from right	HA1F-20 HA1F-210
	3	Maintained Spring from right Spring from left Spring from both	HA1F-30 HA1F-310 HA1F-320 HA1F-330

Part Numbers: Lenses/Handles

Appearance	Part Number
Standard 	LA1A-F-②
Oversize 	HA1A-F-②

 In place of ② specify Lens Color Code from table.

Part Number: Safety Lever Lock

Appearance	Part Number
	HA9Z-LS

Part Numbers: Contacts

Appearance	Terminal Style			
	Contacts	Solder Tab	PCB	
	Gold	SPDT DPDT	HA-C1 HA-C2	HA-C10V HA-C20V
		Silver	SPDT DPDT	HA-C50 HA-C60

 1. All assembled selectors on previous pages use DPDT contacts. SPDT contacts are for use only on two position selectors.



② LED/Lens Color Code

Color	Code
Amber	A
Green	G
Red	R
Blue	S
Yellow	Y
White	W

Part Number: Lamp Holder

Appearance	Part Number
	HA9Z-AH

Part Numbers: Lamps

Appearance	Voltage	Part Numbers
LED 	5V DC 6V AC/DC 12V AC/DC 24V AC/DC 120V AC	LFTD-5② LFTD-6② LFTD-1② LFTD-2② LFTD-H2②
Incandescent 	6V AC/DC 12V AC/DC 24V AC/DC	LH-06 LH-14 LH-28

 In place of ② specify LED Color Code from table.

Pushbutton Selectors (Assembled)

Part Numbers: Pushbutton Selectors

Style	Terminal Style		
	Solder Tab	PCB	
	2 Position	HA1R-2C6-①	HA1R-2C2V-①
	3 Position	HA1R-3C6-①	HA1R-3C2V-①

① Button Color Code

Color	Code
Black	B
Green	G
Red	R
Blue	S
Yellow	Y



- In place of ① specify Button Color Code.
- PCB terminal models also available with silver contacts (change "1" or "2" to "5" or "6" respectively, ie HA1R-2C2V-① becomes HA1R-2C6V-①).

Contact Operation

Style	Operator Position					
	Left		Center		Right	
	Normal	Depressed	Normal	Depressed	Normal	Depressed
2 Position			—	—		
3 Position				Blocked		

Lever Switch (Assembled)

Part Numbers: Lever Switches

Style	Operation	Contacts	Terminal Type		
			Solder Tab	PCB	
	Maintained		DPDT	LA1T-2C6	LA1T-2C2V
	Spring return from top		DPDT	LA1T-21C6	LA1T-21C2V
	Spring Return from bottom		DPDT	LA1T-22C6	LA1T-22C2V
3-Position	Maintained		DPDT	LA1T-3C6	LA1T-3C2V
	Spring return from top		DPDT	LA1T-31C6	LA1T-31C2V
	Spring return from bottom		DPDT	LA1T-32C6	LA1T-32C2V
	Spring return from both		DPDT	LA1T-33C6	LA1T-33C2V



PCB terminal models also available with silver contacts (change "1" or "2" to "5" or "6" respectively, ie LA1T-2C2V becomes LA1T-2C6V).

Contact Operation

Contacts	Operator Position & Contact Operation	Operator Position & Contact Operation		
		Down	Center	Up
2-pos. (DPDT)	Maintained Spring from Top			
2-pos. (DPDT)	Spring Return from Bottom			
3-pos. (DPDT)	All models			











As viewed from front of switch.

Accessories

A2

Switches & Pilot Devices

Part		Specifications	Part Number	Notes	
Ring Wrench		Made of metal	MT-001	Used for tightening the plastic locking ring when installing the L6 series unit on a panel. Tightening torque should not exceed 9kgf cm when tightening a locking ring.	
Lamp Holder Tool (Made of Rubber)		Made of rubber. Used for removing and replacing LED and incandescent lamps in illuminated units.	OR-44	Rubber tool used for replacing LED and incandescent lamps.	
Lens Removal Tool		For illuminated pushbuttons and pilot lights.	MT-101	Used for removing the lens or button from the housing.	
LED Lamp		5V DC 6V AC/DC 12V AC/DC 24V AC/DC 120V AC	LFTD-5② LFTD-6② LFTD-1② LFTD-2② LFTD-H2②	T 1-3/4 miniature flange base. In place of ② specify LED Color Code (see page A2-43).	
Incandescent Lamp		6V AC/DC 12V AC/DC 24V AC/DC	LH-06 LH-14 LH-28	0.5W, T 1-3/4 miniature flange base	
Switch Guard		90 degrees opening maintained	Round/Square	AL-K6	Prevents inadvertent switch operation. IP40 dust-tight rated.
			Rectangular	AL-KH6	
		180 degrees opening, spring return	Round/Square	AL-K6SP	Prevents inadvertent switch operation. IP65 oiltight rated.
			Rectangular	AL-KH6SP	
Dust-proof Cover		For round units	AL-D6	Provides extra level of sealing for "front-panel" portion of switches. (Not applicable for units with oversize lenses or buttons).	
		For square units	AL-DQ6		
		For rectangular units	AL-DH6		
Terminal Cover		Made of white nylon	All removable contacts	H6-VL2	Covers terminals to prevent possible electric shock.
			Unibody Pilot Lights	H6-PVL	
Mounting Hole Plug		Rubber	AL-B6	Fills unused panel cutouts. Made of nitrile rubber. Push-in installation from front of panel. IP65 (oiltight) rated.	
		Aluminum	AL-BM6	Fills unused panel cutouts. Made of aluminum. Screw-on locking ring from inside of panel. IP65 (oiltight) rated.	
Replacement Keys		for LA1K (#132)	AS6-SK	Pair of keys.	
		for HA1K (#231)	KG9Z-SK		
Replacement Engraving Inserts		Round Square Rectangle Oversize Round Oversize Square Mushroom	AL6M-W AL6Q-W AL6H-W HA9Z-P1-W HA9Z-P2-W HA9Z-P13-W		
Replacement Locking Ring		All models	HA9Z-LN		
Replacement Anti-Rotation Ring		L6 standard	AL6-LP	Prevents rotation of switches in panel. (included with all assembled switches)	
		L6 oversize	HA9Z-LP		
Replacement Selector Inserts			HA9Z-HC1-①	Applicable to round oversize selectors only ① = (G, R, S, W, Y)	
Replacement Safety Lever Lock			HA9Z-LS		

Dimensions

Non-Illuminated Pushbuttons (LA*B)

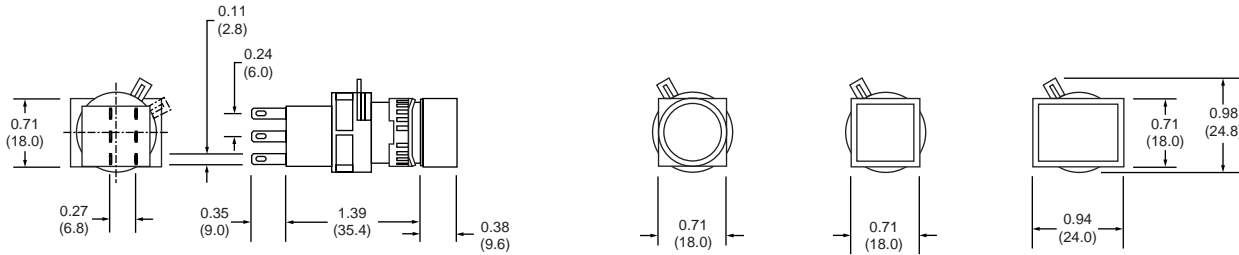

Emergency Stop Switch (HA1B)

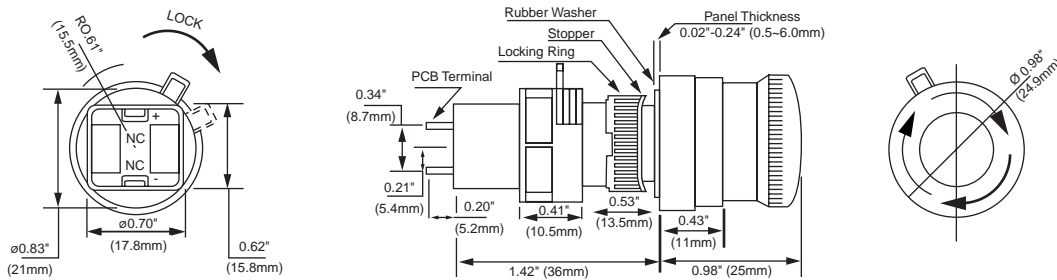

Emergency Stop Switch (HA1E) - Short Body Style

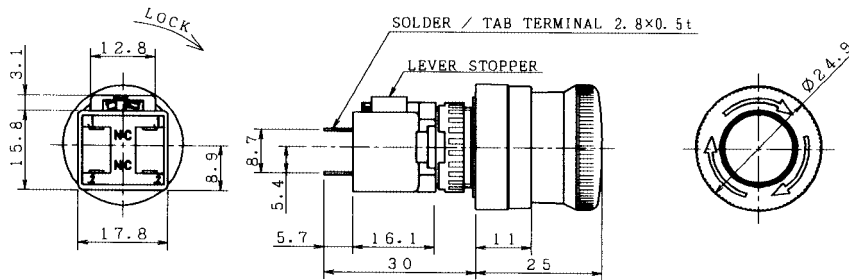

Buzzer (LA3Z)

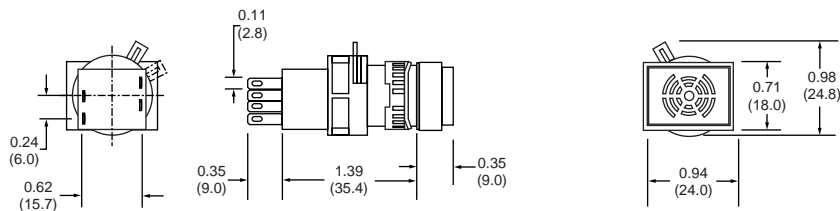

Pilot Lights (LA*P)

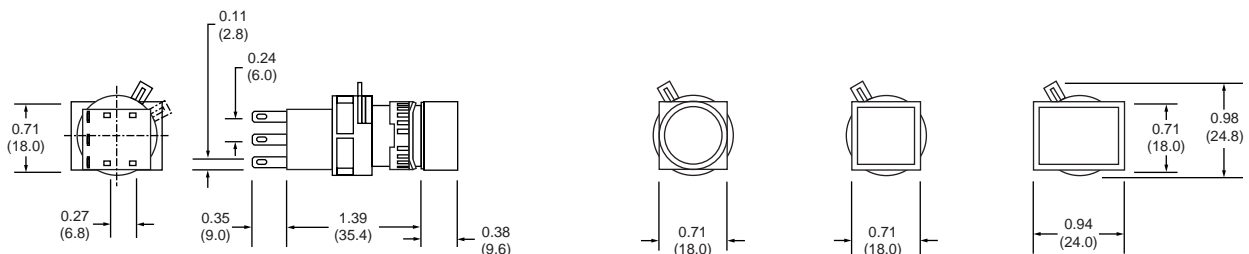

A2

Switches & Pilot Devices

Dimensions con't

A2

Switches & Pilot Devices

Illuminated Pushbuttons (LA*L)

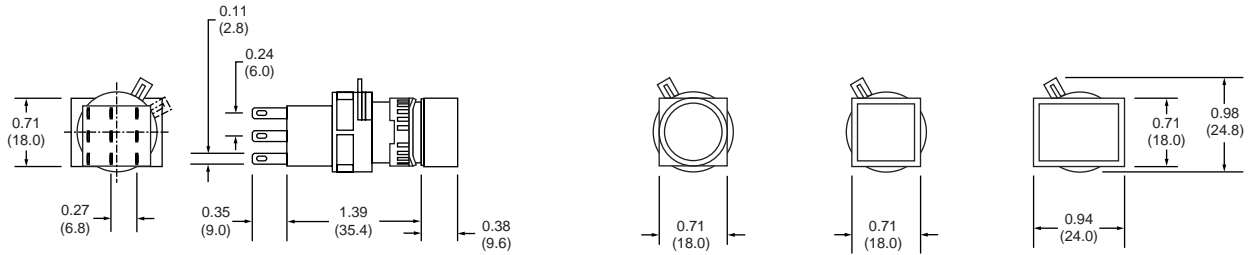

Key Switches (LA*K)

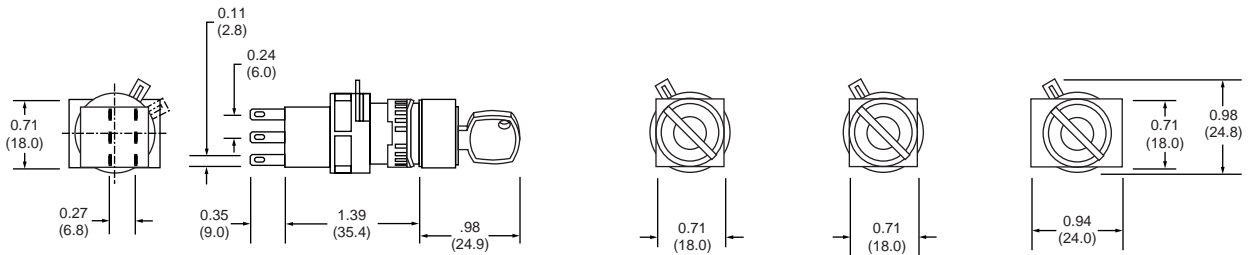

Selector Switches (LA*S)

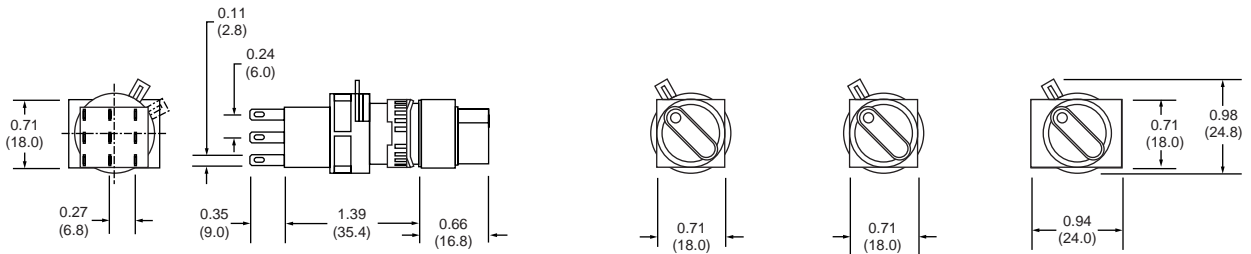

Panel Cut-Out

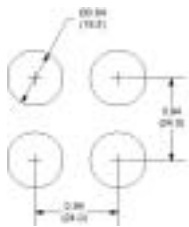

PCB Layout (except for Buzzer and E-Stop)

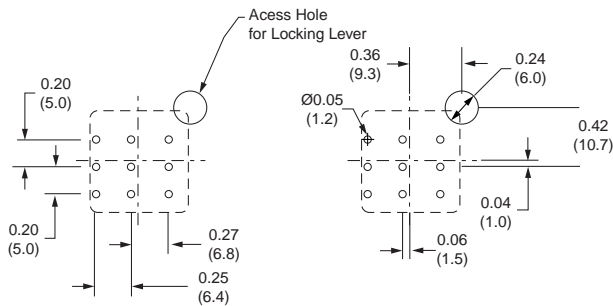

PCB Pins

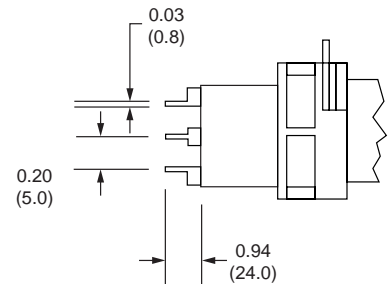

HA1B E-Stop

PCB Mounting Pattern

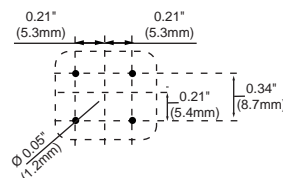

Dimensions con't

Oversize Flush Pushbutton and Pilot Lights

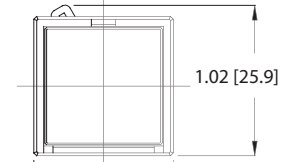
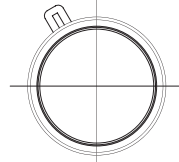
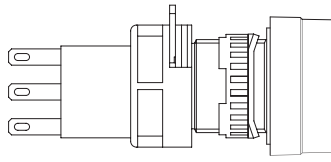
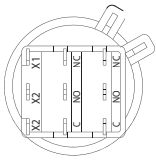

0.43 [11.0]

0.94 [24.0]

Oversize Extended Non-Illuminated Pushbutton

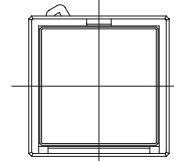
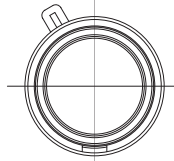
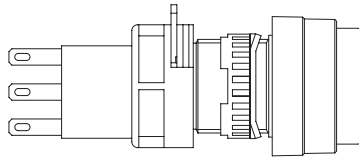
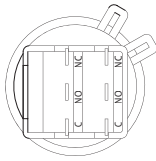

0.59 [15.1]

Oversize Unibody Pilot Lights

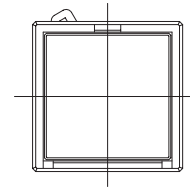
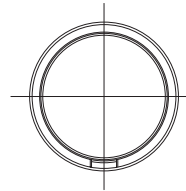
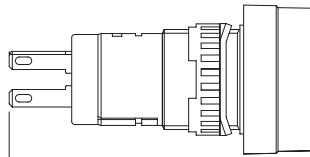
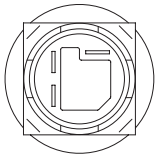

1.48 [37.5]

Mushroom Pushbuttons

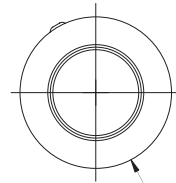
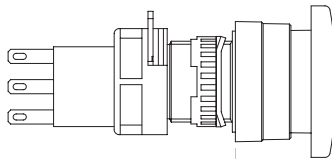
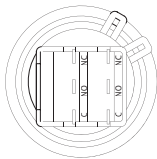

0.79 [20.0]

1.18 [30.0]

Oversize Selector Switch

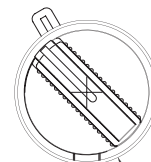
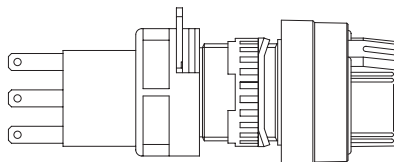
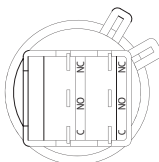

0.77 [19.5]

0.94 [23.8]

A2
Switches & Pilot Devices

Dimensions con't

Oversize Key Switch

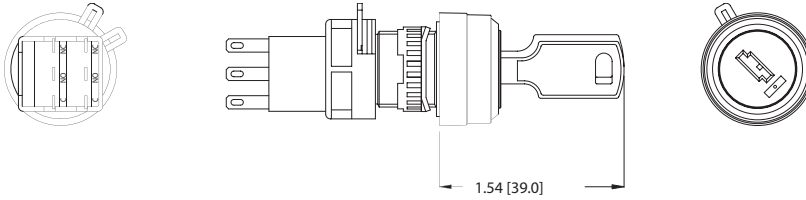

Lever Switch

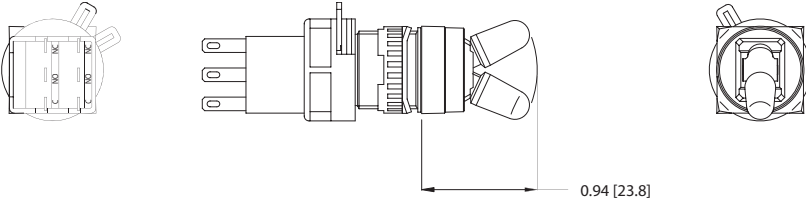

Terminal Configurations

Non Illuminated Pushbutton

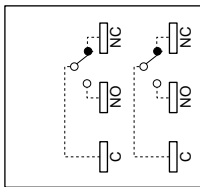

Pilot Lights

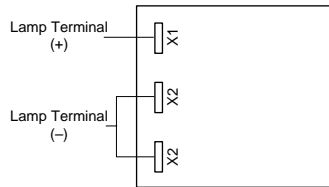

Illuminated Pushbuttons

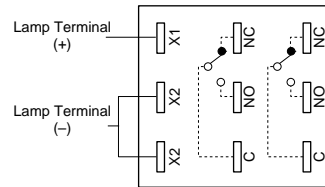

Buzzer

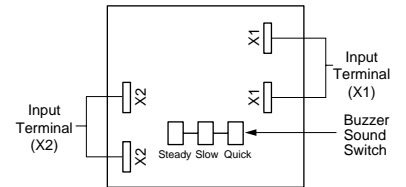

AL-KH6SP

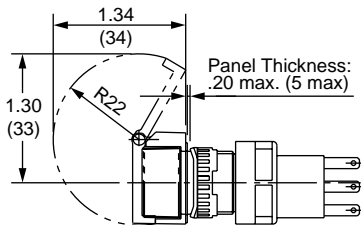
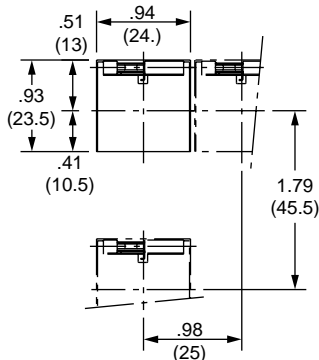

AL-K6SP

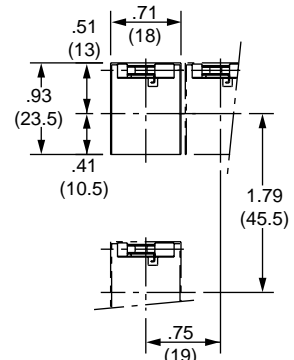

AL-D6

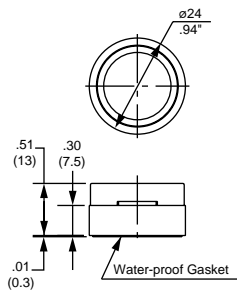

AL-DQ6

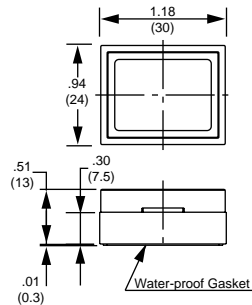

AL-DH6

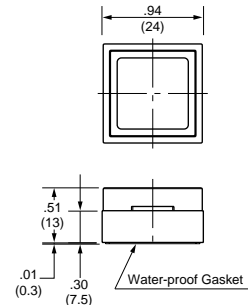

Dimensions con't

H6-VL2

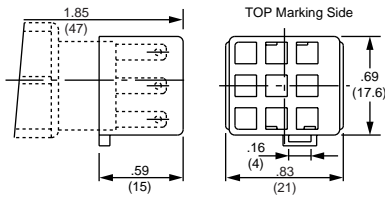

AL-B6

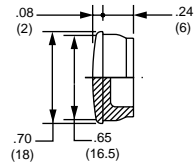

AL-BM6

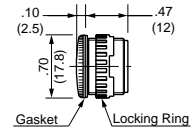

A2

Switches & Pilot Devices

LED Lamp

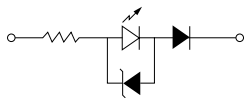

Internal Circuit

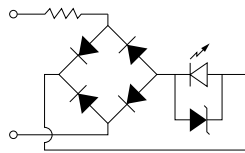
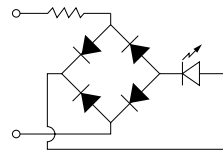

- LED Chip
- Protective Diode
- Zener Diode

General Instructions

Pushbutton Assembly

Lamp Installation

Lamps can be replaced in two ways:

1. If contacts are accessible (or pushbutton not installed in a panel) then it is easiest to first remove the contacts from the operator. This will allow easy access to the lamp/lamp-holder assembly. Grab lamp, depress slightly, and turn counter clockwise. Lamp can then be removed by pushing it back through the lamp holder.

2. If contacts are not accessible, then the lamp can be replaced by first removing the lens from the operator. Just pull lens straight out either with a fingernail or optional lens removal tool (MT-101). Lamp/lamp-holder assembly can then be removed with lamp removal tool (OR-44). Insert lamp removal tool through operator, depress slightly, turn counter clockwise, then pull lamp/lamp-holder assembly out. Lamp can then be removed by pushing it back through the lamp holder.



Engraving Lenses

All buttons and lenses can be engraved directly on the outside surface. Illuminated lenses also allow for engraving on a plate that is underneath the colored section of the lens. Remove the colored section of the lens by pulling on the edge while simultaneously unhooking it from the latches on the lens holder. The marking plate will then be accessible. It can then be engraved or a thin marked insert (such as mylar or paper) can be sandwiched between the marking plate and colored section of the lens.

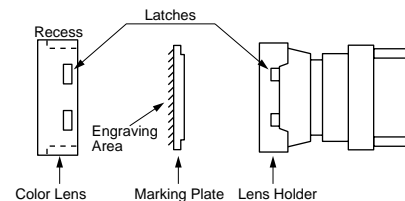

Panel Mounting

Before any unit can be mounted into a panel, the contact block must be removed. Slide metal locking lever and pull contact off. Loosen and remove the locking ring and square anti-rotation ring from the operator and insert operator through panel cutout from the front of the panel. Slide on anti-rotation ring and tighten locking ring, using locking ring wrench (MT-001). Slide contact block onto operator, observing TOP marking on both parts. Slide metal locking lever in direction indicated by LOCK. The yellow plastic safety lever lock can then be snapped onto the locking lever; this will prevent vibration or maintenance actions from releasing the contact from the operator.

PCB Mounting

Being able to separate the contacts from the operator allows for assembly of the front panel components (operator and lens) to be performed in tandem with the PC board assembly and soldering. For applications where multiple rows of pushbuttons are mounted closely together, or where other components may obstruct access to the contact locking lever, be sure to include access holes in the PC board (refer to PC board layout dimensions for location). Also be sure to allow for space above and to the side of contact to ensure that no components block the contact block locking lever. PC board pins are designed to rest on the PCB, take this into consideration to ensure that pins do not short closely spaced traces.



A3

Switches & Pilot Devices



HW: The Best Engineered Switch in the World

Key features include:

- Locking lever removable contact blocks
- Finger-safe IP20 contacts as standard, other terminal styles available
- Tamperproof construction
- All E-stops meet EN418 and are compliant with SEMI S2 standards
- Worldwide approvals
- Easy to assemble
- Available assembled or as sub-components
- Choice of black plastic or metallic front bezels
- Incandescent or LED illumination
- Transformer or full voltage
- Slow make double break self cleaning contacts

IDEC's HW switches are "The best engineered switch in the world" for a reason. Carrying the CE mark, UL, CSA, CCC (Chinese), and TUV approvals, these switches are designed for use in almost any part of the world.

Complete with finger-safe contact blocks offering IP20 protection, these 7/8" (22mm) switches include illuminated and non-illuminated pushbuttons, pilot lights, selector switches, and emergency stop switches.

All switches also incorporate mechanically keyed safety locking levers, ensuring correct installation and maintaining safety in high-vibration applications.



File No. E68961



File No. LR92374



TÜV Rheinland

Registration No. R9551089 (E-stops)
 Registration No. R50054316 (Dual Pushbuttons)
 Registration No. J9650511 (Pilot Lights)
 Registration No. J9551458 (all other switches)



Certificate No.
 2005010305145656

Conforming to Standards		EN60947-1, EN60947-5-1, VDE0660-200, UL508, CSA C22-2 No.14							
Approvals		<p>CSA: pushbuttons and selector switches: A600 pilot lights and illuminated pushbuttons, direct supply pilot lights and illuminated pushbuttons with integral transformer (100/110, 115, 120, 200/220, 230, 240, 380, 400/440, 480V) UL: pushbuttons and selector switches: A600 pilot lights and illuminated pushbuttons, direct supply pilot lights and illuminated pushbuttons with integral transformer (100/110, 115, 120, 200/220, 230, 240, 380, 400/440, 480V) TÜV: pushbuttons and selector switches: A600=P600 (NO, NC)/Q600 (NO-EM, NC-LB) pilot lights and illuminated pushbuttons, direct supply pilot lights and illuminated pushbuttons with integral transformer (100/110, 115, 120, 200/220, 230, 240, 380, 400/440, 480V)</p>							
 File No. E68961  File No. LR92374  Certificate No. 2005010305145656   TÜV Rheinland Registration No. R9551089 (E-stops) Registration No. J9551458 (all other switches) Registration No. J9650511 (Pilot Lights)									
Operating Temperature		Operation: -25 to +50°C (without freezing), Storage: -40 to +70°C (without freezing)							
Vibration Resistance		10 to 55Hz, 98m/sec ² (10G) conforming to IEC6068-2-6							
Shock Resistance		980m/sec ² (100G) conforming to IEC6068-2-7							
Electric Shock Protection		Class 0 conforming to IEC60536							
Degree of Protection (conforming to IEC60529) (conforming to NEMA ICS6-110)		IP65 (from front of the panel) IP20 (Type HW-F contact block) NEMA 1, 2, 3, 3R, 3S, 4, 4X, 5, 12, 13 (from front of panel)							
Mechanical Life		Momentary pushbuttons: 5,000,000 (900 operations per hour), All other switches: 500,000							
Pollution Degree (conforming to IEC60947-1)		3 for switches not using a transformer, 2 for switches using a transformer							
Rated Operational Characteristics		AC-15: A600 or Ue = 250V, Ie = 3A (NO, NC, NO-EM, NC-LB) DC-13: P600 or Ue = 125V, Ie = 1.1A (NO, NC) DC-13: Q600 or Ue = 125V, Ie = 0.9A (NO-EM, NC-LB)							
Rated Insulation Voltage		600V							
Rated Switching Over-Voltage		Less than 4kV, conforming to IEC60947-1							
Rated Impulse Withstanding Voltage		4kV for contact circuit, 2.5kV for lamp circuit							
Rated Thermal Current		10 Amp							
Minimum Switching Capacity		5 mA at 3V AC/DC							
Contact Operation		Slow break NC or NO, self-cleaning							
Positive Action Operation (Emergency Stops with NC contacts)		5.5mm to 10mm travel to latch 45N minimum force to latch 10mm maximum travel 1,800 operations per hour maximum for a Pushlock Turn Reset 900 operations per hour maximum for a Push-Pull							
Operating Force		Flush and extended pushbuttons—with 1NO or 1NC contact: 6.2±2N (momentary), 7.0±2N (main- tained) Additional contacts—1NO or 1NC: +3.2N (momentary), + 3.3N (maintained)							
Terminal Referencing		Conforming to CENELEC EN50005							
Recommended Terminal Torque		0.8 N m (7.1 in lb.)							
External Short-Circuit Protection		10A 250V fuse conforming to IEC60269-1							
Applicable Wire Size		Minimum 1 x 22 AWG, max. 2 x 14 AWG or 1 x 12 AWG							
Contact Resistance		Initial contact resistance of 50mΩ or less							
Contact Gap		4mm (NO and NC), 2mm (NO-EM and NC-LB)							
Horsepower Rating		Reference Value: 1/4 HP @ 120V (1ø non-reversing), 1HP @ 240V (3ø non-reversing)							
Electrical Reliability		MTBF < 1 fault for 10 million operation cycles (3V DC, 5mA)							
Lamp Ratings		Incandescent: 1 W LEDs: 6V/17mA max, 12V & 24V/11mA max, 120 & 240V/10mA max							
Maximum Inrush Current		40 A (40 ms)							
Contact Material		Silver (gold plated contacts available - contact IDEC)							
Contact Ratings	Pushbuttons		Contact Block		Type HW-C/HW-F /HW-G				
	Illuminated Pushbuttons		Rated Insulation Voltage		600V				
	Selector Switches		Rated Continuous Current		10A				
	Illuminated Selector Switches Pushbutton Selectors		Contact Ratings by Utilization Category IEC 60947-5-1		AC-15 (A600) DC-13 (P600)				
Characteristics	Operational Voltage		24V	48V	50V	110V	220V	440V	
	Operational Current	AC 50/60 Hz	AC-12 Control of resistive loads & solid state loads	10A	—	10A	10A	6A	2A
			AC-15 Control of electromagnetic loads (> 72VA)	10A	—	7A	5A	3A	1A
	Operational Current	DC	DC-12 Control of resistive loads & solid state loads	8A	5A	—	2.2A	1.1A	—
DC-13 Control of electromagnets			5A	2A	—	1.1A	0.6A	—	



1. For dimensions, see page A3-100.
2. For life expectancy derating curves, see page A3-105.

Non-Illuminated Pushbuttons (Assembled)

Part Numbers: Non-Illuminated Pushbuttons

Style	Contact	Plastic Bezel		Metal Bezel	
		Momentary	Maintained	Momentary	Maintained
Round Flush 	1NO	HW1B-M1F10-①	HW1B-A1F10-①	HW4B-M1F10-①	HW4B-A1F10-①
	1NC	HW1B-M1F01-①	HW1B-A1F01-①	HW4B-M1F01-①	HW4B-A1F01-①
	1NO-1NC	HW1B-M1F11-①	HW1B-A1F11-①	HW4B-M1F11-①	HW4B-A1F11-①
	2NO	HW1B-M1F20-①	HW1B-A1F20-①	HW4B-M1F20-①	HW4B-A1F20-①
	2NC	HW1B-M1F02-①	HW1B-A1F02-①	HW4B-M1F02-①	HW4B-A1F02-①
	2NO-2NC	HW1B-M1F22-①	HW1B-A1F22-①	HW4B-M1F22-①	HW4B-A1F22-①
Round Extended 	1NO	HW1B-M2F10-①	HW1B-A2F10-①	HW4B-M2F10-①	HW4B-A2F10-①
	1NC	HW1B-M2F01-①	HW1B-A2F01-①	HW4B-M2F01-①	HW4B-A2F01-①
	1NO-1NC	HW1B-M2F11-①	HW1B-A2F11-①	HW4B-M2F11-①	HW4B-A2F11-①
	2NO	HW1B-M2F20-①	HW1B-A2F20-①	HW4B-M2F20-①	HW4B-A2F20-①
	2NC	HW1B-M2F02-①	HW1B-A2F02-①	HW4B-M2F02-①	HW4B-A2F02-①
	2NO-2NC	HW1B-M2F22-①	HW1B-A2F22-①	HW4B-M2F22-①	HW4B-A2F22-①
29mm Mushroom Head 	1NO	HW1B-M3F10-①	HW1B-A3F10-①	HW4B-M3F10-①	HW4B-A3F10-①
	1NC	HW1B-M3F01-①	HW1B-A3F01-①	HW4B-M3F01-①	HW4B-A3F01-①
	1NO-1NC	HW1B-M3F11-①	HW1B-A3F11-①	HW4B-M3F11-①	HW4B-A3F11-①
	2NO	HW1B-M3F20-①	HW1B-A3F20-①	HW4B-M3F20-①	HW4B-A3F20-①
	2NC	HW1B-M3F02-①	HW1B-A3F02-①	HW4B-M3F02-①	HW4B-A3F02-①
	2NO-2NC	HW1B-M3F22-①	HW1B-A3F22-①	HW4B-M3F22-①	HW4B-A3F22-①
40mm Mushroom Head 	1NO	HW1B-M4F10-①	HW1B-A4F10-①	HW4B-M4F10-①	HW4B-A4F10-①
	1NC	HW1B-M4F01-①	HW1B-A4F01-①	HW4B-M4F01-①	HW4B-A4F01-①
	1NO-1NC	HW1B-M4F11-①	HW1B-A4F11-①	HW4B-M4F11-①	HW4B-A4F11-①
	2NO	HW1B-M4F20-①	HW1B-A4F20-①	HW4B-M4F20-①	HW4B-A4F20-①
	2NC	HW1B-M4F02-①	HW1B-A4F02-①	HW4B-M4F02-①	HW4B-A4F02-①
	2NO-2NC	HW1B-M4F22-①	HW1B-A4F22-①	HW4B-M4F22-①	HW4B-A4F22-①
60mm Jumbo Mushroom Head 	1NO	HW1B-M5F10-①*	—	—	—
	1NC	HW1B-M5F01-①*	—	—	—
	1NO-1NC	HW1B-M5F11-①*	—	—	—
	2NO	HW1B-M5F20-①*	—	—	—
	2NC	HW1B-M5F02-①*	—	—	—
	2NO-2NC	HW1B-M5F22-①*	—	—	—
Square Flush 	1NO	HW2B-M1F10-①	HW2B-A1F10-①	—	—
	1NC	HW2B-M1F01-①	HW2B-A1F01-①	—	—
	1NO-1NC	HW2B-M1F11-①	HW2B-A1F11-①	—	—
	2NO	HW2B-M1F20-①	HW2B-A1F20-①	—	—
	2NC	HW2B-M1F02-①	HW2B-A1F02-①	—	—
	2NO-2NC	HW2B-M1F22-①	HW2B-A1F22-①	—	—
Square Extended 	1NO	HW2B-M2F10-①	HW2B-A2F10-①	—	—
	1NC	HW2B-M2F01-①	HW2B-A2F01-①	—	—
	1NO-1NC	HW2B-M2F11-①	HW2B-A2F11-①	—	—
	2NO	HW2B-M2F20-①	HW2B-A2F20-①	—	—
	2NC	HW2B-M2F02-①	HW2B-A2F02-①	—	—
	2NO-2NC	HW2B-M2F22-①	HW2B-A2F22-①	—	—

① Button Color Code

Color	Code
Black	B
Green	G
Red	R
Blue	S
White	W
Yellow	Y
Grey	N*

* Grey is available for Round Flush models only.



1. In place of ①, specify the Button Color Code.
2. * Jumbo mushroom available only in red, green, black, and yellow.
3. For nameplates and accessories, see page A3-96 and A3-98.
4. For dimensions, see page A3-100.
5. For sub-assembly part numbers, see page A3-56.

Non-Illuminated Pushbuttons (Partial-Assemblies)

Contact Assembly + Operator Assembly + Complete Switch



A3

Switches & Pilot Devices

Part Numbers: Operator Assemblies

Style		Plastic Bezel	Metal Bezel
Round Flush		HW1B-M1-①	HW4B-M1-①
		HW1B-A1-①	HW4B-A1-①
Round Extended		HW1B-M2-①	HW4B-M2-①
		HW1B-A2-①	HW4B-A2-①
29mm Mushroom Head		HW1B-M3-①	HW4B-M3-①
		HW1B-A3-①	HW4B-A3-①
40mm Mushroom Head		HW1B-M4-①	HW4B-M4-①
		HW1B-A4-①	HW4B-A4-①
60mm Mushroom Head		HW1B-M5-①*	-

Style		Plastic Bezel	Metal Bezel
Square Flush		HW2B-M1-①	-
		HW2B-A1-①	-
Square Extended		HW2B-M2-①	-
		HW2B-A2-①	-



1. In place of ①, specify the Button Color Code from table below.
2. For complete sub-assemblies, see page A3-56.

Part Numbers: Contact Assemblies

Style	Contacts	Part Number
Standard Fingersafe Contacts	1NO	HW-CBF10
	1NC	HW-CBF01
	1NO/1NC	HW-CBF11
	2NO	HW-CBF20
	2NC	HW-CBF02
Spring Up Terminal Contacts	1NO	HW-CB10
	1NC	HW-CB01
	1NO/1NC	HW-CB11
	2NO	HW-CB20
	2NC	HW-CB02
	2NO/2NC	HW-CB22

① Button Color Code

Color	Code
Black	B
Green	G
Red	R
Blue	S
White	W
Yellow	Y
Grey	N*

*Grey is available for round flush only.



*60mm mushroom available in red, green, black and yellow only.

Non-Illuminated Pushbuttons (Sub-Assembled)

Contact Blocks + Adaptor & Safety Lever Lock + Anti-Rotation Ring + Operator + Button = Complete Part



A3

Switches & Pilot Devices

Part Numbers: Operators

Style		Plastic Bezel	Metal Bezel
Round Flush/Extended	Momentary	HW1B-M0	HW4B-M0
	Maintained	HW1B-A0	HW4B-A0
Ø 29mm Mushroom Ø 40mm Mushroom	Momentary	HW1B-M0L	HW4B-M0L
	Maintained	HW1B-A0L	HW4B-A0L
Ø 60mm Jumbo Mushroom	Momentary	HW1B-M5-①*	-
Square Flush Extended	Momentary	HW2B-M0	-
	Maintained	HW2B-A0	-

Part Numbers: Contact Blocks

Style	1NO	1NC
Standard Fingersafe Contacts (IP20)	HW-F10 HW-F10R (early make)	HW-F01 HW-F01R (late break)
Spring-Up Terminal Contacts	HW-G10 HW-G10R (early make)	HW-G01 HW-G01R (late break)
Exposed Screw Terminal Contacts	HW-C10 HW-C10R (early make)	HW-C01 HW-C01R (late break)
Dummy Block	TW-DB	

Part Numbers: Buttons

Style	Part Number
Round Flush	HW1A-B1-①
Round Extended	HW1A-B2-①
Ø 29mm Mushroom Cap	HW1A-B3-①
Ø 40mm Mushroom Cap	HW1A-B4-①
Square Flush	HW2A-B1-①
Square Extended	HW2A-B2-①

- 1. In place of ①, specify the Button Color Code from table below.
- 2. *60mm mushroom operator includes non-removable button (available in red, black, green and yellow only).
- 3. For nameplates and accessories, see page A3-96.
- 4. For dimensions, see page A3-100.

① Button Color Code

Color	Code	Color	Code
Black	B	White	W
Green	G	Yellow	Y
Red	R	Grey	N [†]
Blue	S		

- 1. HW1B-M5 available only in black, red green and yellow.
- 2. [†] Grey available for round flush only.

- 1. All assembled part numbers in catalog include standard (HW-F...) contacts.
- 2. Assembled units with spring-up terminals (HW-G...) can be ordered by removing an "F" from the part number (Ex. HW1B-M1F11-R becomes HW1B-M111-R).
- 3. Units with exposed screw terminals (HW-C...) must be ordered as sub-components.
- 4. All contacts (including non-fingersafe versions) are UL, CSA, and IEC compliant and carry the CE mark.

Part Numbers: Anti-Rotation Ring

Appearance	Part Number
	HW9Z-RL

Use with notched panel cutout to prevent unit rotation.







Part Number: Contact Block Mounting Adaptor (safety lever lock included)

Style	Part Number
	HW-CB2C

- 1. Used to mount contact blocks to operator (first pair only).
- 2. IDEC strongly recommends using the safety lever lock (included) to prevent heavy vibration or maintenance personnel from inadvertently unlocking contacts.

Emergency Stop Pushbuttons (Assembled)

Part Numbers: Non-Illuminated Emergency Stop Pushbuttons

Style	Contact	Plastic Bezel	Metal Bezel
ø 40mm Head Push-Pull 	1NO 1NC 1NO-1NC 2NC 2NO	HW1B-Y2F10-①† HW1B-Y2F01-①† HW1B-Y2F11-①† HW1B-Y2F02-①† HW1B-Y2F20-①†	HW4B-Y2F10-①† HW4B-Y2F01-①† HW4B-Y2F11-①† HW4B-Y2F02-①† HW4B-Y2F20-①†
ø 29mm Head Pushlock Turn Reset 	1NO 1NC 1NO-1NC 2NO 2NC	HW1B-V3F10-R* HW1B-V3F01-R* HW1B-V3F11-R* HW1B-V3F20-R* HW1B-V3F02-R*	HW4B-V3F10-R* HW4B-V3F01-R* HW4B-V3F11-R* HW4B-V3F20-R* HW4B-V3F02-R*
ø 40mm Head Pushlock Turn Reset 	1NO 1NC 1NO-1NC 2NO 2NC	HW1B-V4F10-①† HW1B-V4F01-①† HW1B-V4F11-①† HW1B-V4F20-①† HW1B-V4F02-①†	HW4B-V4F10-①† HW4B-V4F01-①† HW4B-V4F11-①† HW4B-V4F20-①† HW4B-V4F02-①†
ø 40mm Head EMO Pushlock Turn Reset 	1NO 1NC 1NO-1NC 2NO 2NC	HW1B-V4F10-R-EMO-2 HW1B-V4F01-R-EMO-2 HW1B-V4F11-R-EMO-2 HW1B-V4F20-R-EMO-2 HW1B-V4F02-R-EMO-2	HW4B-V4F10-R-EMO-2 HW4B-V4F01-R-EMO-2 HW4B-V4F11-R-EMO-2 HW4B-V4F20-R-EMO-2 HW4B-V4F02-R-EMO-2
ø 40mm Head Pushlock Key Reset 	1NO 1NC 1NO-1NC 2NO 2NC	HW1B-X4F10-R* HW1B-X4F01-R* HW1B-X4F11-R* HW1B-X4F20-R* HW1B-X4F02-R*	HW4B-X4F10-R* HW4B-X4F01-R* HW4B-X4F11-R* HW4B-X4F20-R* HW4B-X4F02-R*
ø 60mm Head Pushlock Turn Reset 	1NO 1NC 1NO-1NC 2NO 2NC	HW1B-V5F10-R* HW1B-V5F01-R* HW1B-V5F11-R* HW1B-V5F20-R* HW1B-V5F02-R*	-
ø 40mm Head Unibody Pushlock Turn Reset 	1NO-1NC 2NC 1NO-2NC	HW1E-BV4F11-R* HW1E-BV4F02-R* HW1E-BV412R-TK2093-1**	-

Part Numbers: Illuminated Emergency Stop Pushbuttons

Style	Illumination Type	Contact	Part Number
	LED	1NO-1NC 2NC 2NC (with active lamp circuit) 1NO-1NC (with active lamp circuit)	HW1E-LV4F11QD-R*-③ HW1E-LV4F02QD-R*-③ HW1E-TV4F02QD-R*-③ HW1E-TV4F11QD-R*-③
	Incandescent	1NO-1NC 2NC 1NO-1NC (with active lamp circuit) 2NC (with active lamp circuit)	HW1E-LV4F11Q-R*-③ HW1E-LV4F02Q-R*-③ HW1E-TV4F11Q-R*-③ HW1E-TV4F02Q-R*-③



- * Available in Red only.
- † Available in red or yellow (insert color code in place of ①)
- In place of ③, specify Full Voltage Code.
- With single unit construction, the positive action contacts are integrated in the body of the switch. This provides an extra degree of safety and reliability for critical emergency stop functions.
- In the illuminated version, the light is independent of the switch action (except active lamp circuit model).
- For nameplates and accessories, see page A3-96.
- For dimensions, see page A3-100.
- For sub-assembly part numbers, see next page.
- All HW series E-stops comply with EN418, the IEC "E-Stop Addendum to the Low Voltage Directive," this includes "tamper proof" operation whereby a change of contact state is not possible by "teasing" or "floating" the operator.
- "Active Lamp Circuit" consists of a built-in Normally Open contact in series with the lamp. This allows the lamp to illuminate only when the button is pressed and eliminates the need for external jumpering.
- Replacement Lens is HWLV-LENSR.

Part Numbers: Nameplates

HWAV-Yellow Plastic

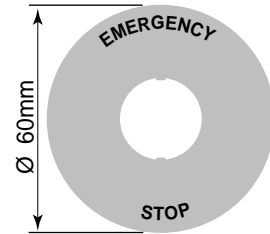

Style	Part Number
60mm Diameter "Emergency Stop"	HWAV-27†
60mm Diameter Blank	HWAV-0
80mm Diameter "Emergency Stop" (for jumbo mushroom use)	HWAV5-27



† HWAV-27 comes marked "Emergency Stop" as shown in drawing.

Part Numbers: E-Stop Shrouds

Style	Part Number
	HW9Z-KG1-TK2120
	HW9Z-KG2-TK2120



Not applicable for 60mm mushroom.

Terminal Numbering (Unibody only)

Models	Terminal Number
1NO-1NC	NO = .3/.4, NC = .1/.2
2NC	NC = 11/12, NC = 21/22
HW1E-L HW1E-T	Lamp + = X2, Lamp - = X1

③ Full Voltage Code

Voltage	Code
6VAC/DC	6V
12VAC/DC	12V
24VAC/DC	24V

Emergency Stop Pushbuttons (Partial-Assemblies)

Contact Assembly + Anti-Rotation Ring + Operator Assembly + Complete Switch



A3

Switches & Pilot Devices

Part Numbers: Operators

Style		Plastic Bezel	Metal Bezel
		HW1B-V3R*	HW4B-V3R*
	red	HW1B-V4R	HW4B-V4R
	yellow	HW1B-V4Y	HW4B-V4Y
		HW1B-V4R-EMO-2*	HW4B-V4R-EMO-2*
	red	HW1B-Y2R	HW4B-Y2R
	yellow	HW1B-Y2Y	HW4B-Y2Y
		HW1B-X4R*	HW4B-X4R*
		HW1B-V5R*	—

Part Numbers: Anti-Rotation Ring

Appearance	Part Number
	HW9Z-RL



Use with notched panel cutout to prevent unit rotation.



- *Available in red only.
- All HW Series Emergency Stop operators include non-removable color caps.
- All HW Series Emergency Stop operators comply with EN418 "E-Stop Addendum to the Low Voltage Directive" (when used as part of a complete HW series Emergency Stop Pushbutton).
- All HW series Emergency Stop switches comply with SEMI S2 standards.

Part Numbers: Contact Assemblies

Style	Contacts	Part Number
	1NO 1NC 1NO/1NC 2NO 2NC 2NO/2NC	HW-CBF10 HW-CBF01 HW-CBF11 HW-CBF20 HW-CBF02 HW-CBF22
	1NO 1NC 1NO/1NC 2NO 2NC 2NO/2NC	HW-CB10 HW-CB01 HW-CB11 HW-CB20 HW-CB02 HW-CB22



Gold contact option is available for spring-up terminals. Add suffix "MAU" to end of part number. For example, HW-CB20 becomes HW-CB20-MAU.

Emergency Stop Pushbuttons (Sub-Assembled)

Contact Blocks + Adaptor & Safety Lever Lock + Anti-Rotation Ring + Operator = Complete Part





A3

Switches & Pilot Devices



Part Numbers: Emergency Stop Operators

Style	Plastic	Metal
 ø 29mm Head Pushlock Turn Reset	HW1B-V3R*	HW4B-V3R*
 ø 40mm Head Pushlock Turn Reset	red HW1B-V4R	HW4B-V4R
	yellow HW1B-V4Y	HW4B-V4Y
 ø 40mm Head EMO Pushlock Turn Reset	HW1B-V4R-EMO-2*	HW4B-V4R-EMO-2*
 ø 40mm Head Push-Pull	red HW1B-Y2R	HW4B-Y2R
	yellow HW1B-Y2Y	HW4B-Y2Y
 ø 40mm Head Pushlock Key Reset	HW1B-X4R*	HW4B-X4R*
 ø 60mm Head Pushlock Turn Reset	HW1B-V5R*	-





-  1. *Available in red only.
-  2. All Emergency Stop Buttons are non-removable from the operator.





Part Number: Contact Block Mounting Adaptor (safety lever lock included)

Style	Part Number
	HW-CB2C

-  1. Used to mount contact blocks to operator (first pair only).
-  2. IDEC strongly recommends using the safety lever lock (included) to prevent heavy vibration or maintenance personnel from unlocking contacts.

Part Numbers: Contact Blocks

Description	Part Number	
	1NO	1NC
 Standard Fingersafe (IP20)	HW-F10 HW-F10R (early make)	HW-F01 HW-F01R (late break)
 Spring-Up Terminal Contacts	HW-G10 HW-G10R (early make) HW-G10-MAU (gold contacts)	HW-G01 HW-G01R (late break) HW-G01-MAU (gold contacts)
 Exposed Screw Terminal Contacts	HW-C10 HW-C10R (early make)	HW-C01 HW-C01R (late break)
 Dummy Block	TW-DB	

-  1. All assembled part numbers in catalog include standard (HW-F..) contacts. (except unibody)
-  2. Assembled units with spring-up terminals (HW-G...) can be ordered by removing an "F" from the part number (Ex. HW1B-M1F11-R becomes HW1B-M111-R).
-  3. Units with exposed screw terminals (HW-C...) must be ordered as sub-components.
-  4. All contacts (including exposed screw) are UL, CSA, and IEC compliant and carry the CE mark.

Part Numbers: Anti-Rotation Ring

Appearance	Part Number
	HW9Z-RL

-  Use with notched panel cutout to prevent unit rotation.

Emergency Stop Stations

Part Numbers: Emergency Stop Stations

Description	Contacts	Plastic Bezel	Metal Bezel
Ø 40mm Pushlock Turn Reset	1NO-1NC	HW1X-BV411-R*	HW4X-BV411-R*
	2NC	HW1X-BV402-R*	HW4X-BV402-R*
Ø 29mm Pushlock Turn Reset	1NO-1NC	HW1X-BV311-R*	HW4X-BV311-R*
	2NC	HW1X-BV302-R*	HW4X-BV302-R*
Ø 40mm Push-Pull Reset	1NO-1NC	HW1X-BY411-R*	HW4X-BY411-R*
	2NC	HW1X-BY402-R*	HW4X-BY402-R*
Ø 40mm Pushlock Key Reset	1NO-1NC	HW1X-BX411-R*	HW4X-BX411-R*
	2NC	HW1X-BX402-R*	HW4X-BX402-R*

-  1. * Available in Red only.
 2. Maximum of two contact blocks.
 3. Available as completed unit only.
 4. Box is supplied with yellow top and black bottom only.

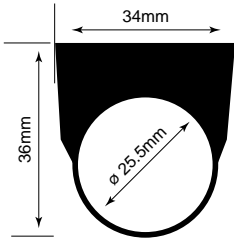

Part Numbers: Nameplates for Emergency Stop Stations

NSA-Aluminum	Color	Part Number	
		Blank	Engraved
	Black	NSA-0	NSA-*
	Red	NSA-0R	NSA-*R

-  1. In place of * please insert the word, letters, or numbers you would like engraved. For standard engravings, see page A3-96.
 2. For specifications on engravings, please consult factory.

Part Numbers: Base Mount Contact Blocks

Configuration	Part Number
1NO	HW-S10
1NC	HW-S01



Part Numbers: Plug Adaptors



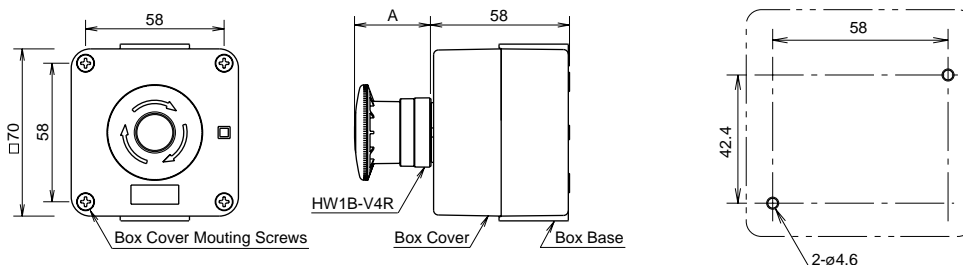

Type	Part Number
G1/2	HW9Z-G
PG16	HW9Z-PG

Panel Mount Dimensions



Pilot Lights (Assembled)

Part Numbers: Pilot Lights

Style			Plastic Bezel	Metal Bezel
Round Flush  (Full Voltage type shown)	Full Voltage		HW1P-1FQ ^④ - ^② - ^③	HW4P-1FQ ^④ - ^② - ^③
	Transformer	120V AC 240V AC 480V AC	HW1P-1FH2 ^④ - ^② HW1P-1FM4 ^④ - ^② HW1P-1FT8 ^④ - ^②	HW4P-1FH2 ^④ - ^② HW4P-1FM4 ^④ - ^② HW4P-1FT8 ^④ - ^②
	DC-DC Converter*	110V DC	HW1P-1D2 ^④ - ^②	-
Dome  (Full Voltage type shown)	Full Voltage		HW1P-2FQ ^④ - ^② - ^③	HW4P-2FQ ^④ - ^② - ^③
	Transformer	120V AC 240V AC 480V AC	HW1P-2FH2 ^④ - ^② HW1P-2FM4 ^④ - ^② HW1P-2FT8 ^④ - ^②	HW4P-2FH2 ^④ - ^② HW4P-2FM4 ^④ - ^② HW4P-2FT8 ^④ - ^②
	DC-DC Converter*	110V DC	HW1P-2D2 ^④ - ^②	-
Square Flush  (Transformer type shown)	Full Voltage		HW2P-1FQ ^④ - ^② - ^③	-
	Transformer	120V AC 240V AC 480V AC	HW2P-1FH2 ^④ - ^② HW2P-1FM4 ^④ - ^② HW2P-1FT8 ^④ - ^②	-
	DC-DC Converter*	110V DC	HW2P-1D2 ^④ - ^②	-
Jumbo Dome 	Full Voltage** 24V AC/DC	LED	HW1P-5Q4- ^②	-
		Incandescent	HW1P-5Q7- ^②	



- In place of ^②, specify the Lens/LED Color Code.
- In place of ^③ specify the Full Voltage Code from table below.
- In place of ^④ specify Lamp Type Code.
- *DC-DC convertor voltage input from 90-140V DC, comes with spring up terminals only.
- **Available with spring up terminals and 24V only.
- For nameplates and accessories, see page A3-96.
- For dimensions, see page A3-100.

② Lens/LED Color Code

Color	Code
Amber	A
Green	G
Red	R
Blue	S
White	W
Yellow	Y

③ Full Voltage Code

Voltage	Code
6V AC/DC	6
12V AC/DC	12
24V AC/DC	24
120V AC (LED only)	120
240VAC (LED only)	240

④ Lamp Type Code

Lamp	Code
Incandescent	Blank
LED	D

Pilot Lights (Partial-Assemblies)

Full Voltage Models

A3

Switches & Pilot Devices

Operator/Lens + Lamp = Complete Pilot Light



Part Numbers: Operator/Lens

Style	Plastic Bezel	Metal Bezel
Round Flush 	HW1P-1FQ0-②	HW4P-1FQ0-②
Dome 	HW1P-2FQ0-②	HW4P-2FQ0-②
Square Flush 	HW2P-1FQ0-②	-

Part Numbers: Lamps

Type	Voltage	Part Number
LED 	6V AC/DC	LSTD-6②
	12V AC/DC	LSTD-1②
	24V AC/DC	LSTD-2②
	120V AC	LSTD-H2②
	240V AC	LSTD-M4②
Incandescent 	6.3V AC/DC	IS-6
	12V AC/DC	IS-12
	24V AC/DC	IS-24
	30V AC/DC	IS-30

- 1. In place of ②, specify the LED Color Code from table on previous page.
- 2. The LED contains a current-limiting resistor and reverse polarity protection diodes.

- 1. In place of ②, specify the Lens Color Code from table on previous page.
- 2. Operator/Lens assembly for use with standard transformers only, not spring up terminal type.

Transformer Models

Transformer/Lamp + Operator/Lens = Complete



Part Numbers: Operator/Lens

Style	Plastic Bezel	Metal Bezel
Round Flush 	HW1P-1F0-②	HW4P-1F0-②
Dome 	HW1P-2F0-②	HW4P-2F0-②
Square Flush 	HW2P-1F0-②	-

Part Numbers: Transformer/Lamp

Item	Voltage	Part Number
	120V AC with LED	HW-FH2-②
	240V AC with LED	HW-FM4-②
	480V AC with LED	HW-FT8-②
	120V AC with Incandescent	HW-FH2
	240V AC with Incandescent	HW-FM4
	480V AC with Incandescent	HW-FT8

- 1. In place of ②, specify the LED Color Code from table on previous page.
- 2. All transformers have a 6V AC secondary voltage.
- 3. LED/Lamp supplied with transformer partial assembly.

- In place of ②, specify the Lens Color Code from table on previous page.

Pilot Lights (Sub-Assembled)

Transformer* + Lamp + Anti-Rotation Ring + Operator + Lens = Complete Part



* Not applicable to full voltage units.

Part Numbers: Operators

Style	Type	Plastic Bezel	Metal Bezel
 Round Flush (HW1P-10 shown)	Full Voltage	Standard	HW1P-1FQ0
		Spring Up Terminals	HW1P-1Q0
	Transformer	Standard	HW1P-10
		Spring Up Terminals	HW1P-100
 Dome (HW1P-20 shown)	Full Voltage	Standard	HW1P-2FQ0
		Spring Up Terminals	HW1P-2Q0
	Transformer	Standard	HW1P-20
		Spring Up Terminals	HW1P-200
 Square Flush (HW2P-10 shown)	Full Voltage	Standard	HW2P-1FQ0
		Spring Up Terminals	HW2P-1Q0
	Transformer	Standard	HW2P-10
		Spring Up Terminals	HW2P-100



- Transformer type requires separate transformer & lamp. Must select correct transformer bases on standard or spring up terminal type. Use 6V lamps or LEDs.
- Full voltage type only requires lamp.

Part Numbers: Transformer Units

Style	Voltage	Part Number
 LED/Incandescent (6V secondary voltage)	120V AC	HW-FH20 HW-MH20 (with spring up terminals)*
	240V AC	HW-FM40 HW-MM40 (with spring up terminals)*
	480V AC	HW-FT80 HW-RT80 (with spring up terminals)*
	110V DC**	HW-RD0 (with spring up terminals)*

- *To use spring up terminal type, must use transformer type operator designed for spring up transformer.
- ** DC-DC converter voltage input from 90-140V DC.

Part Numbers: Lamps

Type	Voltage	Part Number	② Lens/LED Color Code	
			Color	Code
 LED	6V AC/DC	LSTD-6②	Amber	A
	12V AC/DC	LSTD-1②	Green	G
	24V AC/DC	LSTD-2②	Red	R
	120V AC	LSTD-H2②	Blue	S
	240V AC	LSTD-M4②	White	W
 Incandescent	6.3V AC/DC	IS-6	Yellow	Y
	12V AC/DC	IS-12		
	24V AC/DC	IS-24		



- In place of ②, specify the LED Color Code.
- The LED contains a current-limiting resistor and reverse polarity protection diodes.

Part Numbers: Anti-Rotation Ring

Appearance	Part Number
	HW9Z-RL

Use with notched panel cutout to prevent unit rotation.

Part Numbers: Lenses

Style	Part Number
 Round/Flush	HW1A-P1-②
 Dome	HW1A-P2-②
 Square/Flush	HW2A-P1-②

In place of ②, specify the Lens Color Code.

Jumbo Dome Pilot Light Replacement Parts

Description	Item	Part Number
Replacement Jumbo Dome Operator	LED Type	HW1P-5Q0
	Incandescent Type*	HW1P-5Q7
Replacement Jumbo Dome Lens	Polycarbonate Lens	HW1A-P5①
Replacement LED Diffusing Lens		HW9Z-PP5C
Replacement LED Lamps for HW Jumbo Dome	LED Lamp	LSTDDB-2①

*Operator comes with incandescent bulb.

Illuminated Pushbuttons (Assembled)

Part Numbers: Illuminated Pushbuttons

A3

Switches & Pilot Devices

Style	Description	Contacts	Plastic Bezel		Metal Bezel	
			Momentary	Maintained	Momentary	Maintained
Flush 	Full Voltage	1NO 1NC 1NO-1NC 2NO	HW1L-M1F10Q④-②-③ HW1L-M1F01Q④-②-③ HW1L-M1F11Q④-②-③ HW1L-M1F20Q④-②-③	HW1L-A1F10Q④-②-③ HW1L-A1F01Q④-②-③ HW1L-A1F11Q④-②-③ HW1L-A1F20Q④-②-③	HW4L-M1F10Q④-②-③ HW4L-M1F01Q④-②-③ HW4L-M1F11Q④-②-③ HW4L-M1F20Q④-②-③	HW4L-A1F10Q④-②-③ HW4L-A1F01Q④-②-③ HW4L-A1F11Q④-②-③ HW4L-A1F20Q④-②-③
	Transformer 120V AC 240V AC 240V AC	1NO-1NC 2NO 1NO-1NC 2NO	HW1L-M1F11H2④-② HW1L-M1F20H2④-② HW1L-M1F11M4④-② HW1L-M1F20M4④-②	HW1L-A1F11H2④-② HW1L-A1F20H2④-② HW1L-A1F11M4④-② HW1L-A1F20M4④-②	HW4L-M1F11H2④-② HW4L-M1F20H2④-② HW4L-M1F11M4④-② HW4L-M1F20M4④-②	HW4L-A1F11H2④-② HW4L-A1F20H2④-② HW4L-A1F11M4④-② HW4L-A1F20M4④-②
Extended 	Full Voltage	1NO 1NC 1NO-1NC 2NO	HW1L-M2F10Q④-②-③ HW1L-M2F01Q④-②-③ HW1L-M2F11Q④-②-③ HW1L-M2F20Q④-②-③	HW1L-A2F10Q④-②-③ HW1L-A2F01Q④-②-③ HW1L-A2F11Q④-②-③ HW1L-A2F20Q④-②-③	HW4L-M2F10Q④-②-③ HW4L-M2F01Q④-②-③ HW4L-M2F11Q④-②-③ HW4L-M2F20Q④-②-③	HW4L-A2F10Q④-②-③ HW4L-A2F01Q④-②-③ HW4L-A2F11Q④-②-③ HW4L-A2F20Q④-②-③
	Transformer 120V AC 240V AC 240V AC	1NO-1NC 2NO 1NO-1NC 2NO	HW1L-M2F11H2④-② HW1L-M2F20H2④-② HW1L-M2F11M4④-② HW1L-M2F20M4④-②	HW1L-A2F11H2④-② HW1L-A2F20H2④-② HW1L-A2F11M4④-② HW1L-A2F20M4④-②	HW4L-M2F11H2④-② HW4L-M2F20H2④-② HW4L-M2F11M4④-② HW4L-M2F20M4④-②	HW4L-A2F11H2④-② HW4L-A2F20H2④-② HW4L-A2F11M4④-② HW4L-A2F20M4④-②
Extended with Full Shroud 	Full Voltage	1NO 1NC 1NO-1NC 2NO	HW1L-MF2F10Q④-②-③ HW1L-MF2F01Q④-②-③ HW1L-MF2F11Q④-②-③ HW1L-MF2F20Q④-②-③	HW1L-AF2F10Q④-①-③ HW1L-AF2F01Q④-①-③ HW1L-AF2F11Q④-①-③ HW1L-AF2F20Q④-①-③	HW4L-MF2F10Q④-②-③ HW4L-MF2F01Q④-②-③ HW4L-MF2F11Q④-②-③ HW4L-MF2F20Q④-②-③	HW4L-AF2F10Q④-①-③ HW4L-AF2F01Q④-①-③ HW4L-AF2F11Q④-①-③ HW4L-AF2F20Q④-①-③
	Transformer 120V AC 240V AC 240V AC	1NO-1NC 2NO 1NO-1NC 2NO	HW1L-MF2F11H2④-② HW1L-MF2F20H2④-② HW1L-MF2F11M4④-② HW1L-MF2F20M4④-②	HW1L-AF2F11H2④-② HW1L-AF2F20H2④-② HW1L-AF2F11M4④-② HW1L-AF2F20M4④-②	HW4L-MF2F11H2④-② HW4L-MF2F20H2④-② HW4L-MF2F11M4④-② HW4L-MF2F20M4④-②	HW4L-AF2F11H2④-② HW4L-AF2F20H2④-② HW4L-AF2F11M4④-② HW4L-AF2F20M4④-②
40mm Mushroom Head 	Full Voltage	1NO 1NC 1NO-1NC 2NO	HW1L-M4F10Q④-②-③ HW1L-M4F01Q④-②-③ HW1L-M4F11Q④-②-③ HW1L-M4F20Q④-②-③	HW1L-A4F10Q④-②-③ HW1L-A4F01Q④-②-③ HW1L-A4F11Q④-②-③ HW1L-A4F20Q④-②-③	HW4L-M4F10Q④-②-③ HW4L-M4F01Q④-②-③ HW4L-M4F11Q④-②-③ HW4L-M4F20Q④-②-③	HW4L-A4F10Q④-②-③ HW4L-A4F01Q④-②-③ HW4L-A4F11Q④-②-③ HW4L-A4F20Q④-②-③
	Transformer 120V AC 240V AC 240V AC	1NO-1NC 2NO 1NO-1NC 2NO	HW1L-M4F11H2④-② HW1L-M4F20H2④-② HW1L-M4F11M4④-② HW1L-M4F20M4④-②	HW1L-A4F11H2④-② HW1L-A4F20H2④-② HW1L-A4F11M4④-② HW1L-A4F20M4④-②	HW4L-M4F11H2④-② HW4L-M4F20H2④-② HW4L-M4F11M4④-② HW4L-M4F20M4④-②	HW4L-A4F11H2④-② HW4L-A4F20H2④-② HW4L-A4F11M4④-② HW4L-A4F20M4④-②
Square Flush 	Full Voltage	1NO 1NC 1NO-1NC 2NO	HW2L-M1F10Q④-②-③ HW2L-M1F01Q④-②-③ HW2L-M1F11Q④-②-③ HW2L-M1F20Q④-②-③	HW2L-A1F10Q④-②-③ HW2L-A1F01Q④-②-③ HW2L-A1F11Q④-②-③ HW2L-A1F20Q④-②-③	-	-
	Transformer 120V AC 240V AC 240V AC	1NO-1NC 2NO 1NO-1NC 2NO	HW2L-M1F11H2④-② HW2L-M1F20H2④-② HW2L-M1F11M4④-② HW2L-M1F20M4④-②	HW2L-A1F11H2④-② HW2L-A1F20H2④-② HW2L-A1F11M4④-② HW2L-A1F20M4④-②	-	-

1. In place of ② specify the Lens Color Code, in place of ③ specify the Full Voltage Code and in place of ④ specify Lamp Type Code.
2. For partial and sub-assembly part numbers, see pages A3-65 and A3-66.
3. For nameplates and accessories, see page A3-96.
4. For dimensions, see page A3-100.

④ Lamp Type Code

Lamp	Code
Incandescent	Blank
LED	D

② Lens Color Code

Color	Code
Amber	A
Green	G
Red	R
Blue	S
White	W
Yellow	Y*

③ Full Voltage Codes

Voltage	Code
6V AC/DC	6V
12V AC/DC	12V
24V AC/DC	24V
120V AC (LED only)	120V
240VAC (LED only)	240V

*40mm mushroom lenses not available in yellow

Illuminated Pushbuttons (Partial-Assemblies)

Contact Assembly + Lamp* + Operator/Lens = Complete Switch



*Lamp is included in contact assembly for transformer models only.

Part Numbers: Operators/Lens

Type		Plastic Bezel	Metal Bezel
 Flush	Momentary	HW1L-M1-②	HW4L-M1-②
	Maintained	HW1L-A1-②	HW4L-A1-②
 Extended	Momentary	HW1L-M2-②	HW4L-M2-②
	Maintained	HW1L-A2-②	HW4L-A2-②
 Extended/Full shroud	Momentary	HW1L-MF2-②	HW4L-MF2-②
	Maintained	HW1L-AF2-②	HW4L-AF2-②
 Mushroom*	Momentary	HW1L-M4-②*	HW4L-M4-②*
	Maintained	HW1L-A4-②*	HW4L-A4-②*
 Square	Momentary	HW2L-M1-②	—
	Maintained	HW2L-A1-②	



1. In place of ②, specify the Lens Color Code.
2. *Mushroom Lens not available in yellow.

Part Numbers: Full Voltage Contact Assemblies (order lamp separately)

Style	Contacts	Part Number
	1NO	HW-FL10Q0
	2NO	HW-FL20Q0
	1NO/1NC	HW-FL11Q0
	1NC	HW-FL01Q0
	2NC	HW-FL02Q0





Order lamp separately.

Part Numbers: Transformer Contact Assemblies (lamp included)

Style	Contacts	Part Number
 120V AC with LED	1NO	HW-FL10H2-②
	2NO	HW-FL20H2-②
	1NC	HW-FL01H2-②
	1NO/1NC	HW-FL11H2-②
240V AC with LED	1NO	HW-FL10M4-②
	2NO	HW-FL20M4-②
	1NC	HW-FL01M4-②
	1NO/1NC	HW-FL11M4-②
480V AC with LED	1NO	HW-FL10T8-②
	2NO	HW-FL20T8-②
	1NC	HW-FL01T8-②
	1NO/1NC	HW-FL11T8-②
120V AC with Incandescent	1NO	HW-FL10H2
	2NO	HW-FL20H2
	1NC	HW-FL01H2
240V AC with Incandescent	1NO	HW-FL10M4
	2NO	HW-FL20M4
	1NC	HW-FL01M4

Part Numbers: Lamps

Type	Voltage	Part Number
 LED	6V AC/DC	LSTD-6②
	12V AC/DC	LSTD-1②
	24V AC/DC	LSTD-2②
	120V AC	LSTD-H2②
	240V AC	LSTD-M4②
 Incandescent	6.3V AC/DC	IS-6
	12V AC/DC	IS-12
	24V AC/DC	IS-24
	30V AC/DC	IS-30



1. In place of ②, specify the LED Color Code from table below.
2. The LED contains a current-limiting resistor and reverse polarity protection diodes.

② Lens/LED Color Code

Color	Code
Amber	A
Green	G
Red	R
Blue	S
White	W
Yellow	Y

Illuminated Pushbuttons (Sub-Assembled)

Part Numbers: LED and Incandescent Illuminated Pushbuttons

Transformer* + Contact Blocks + Lead Holder + Adaptor† + Lamp + Anti-Rotation Ring + Operator + Lens = Complete Part

A3



- 1. *Transformer not needed with full voltage types.
- 2. † Adaptor includes safety lever lock.

Part Numbers: Lenses

Style	Part Number
Round Flush 	HW1A-L1-②
Round Extended 	HW1A-L2-②
Ø 40mm Mushroom Cap 	ALW4BLU-②*
Square Flush 	HW2A-L1-②

- 1. In place of ②, specify the Lens Color Code.
- 2. *not available in yellow.

Part Numbers: Operators

Style		Part Number	
		Plastic Bezel	Metal Bezel
Round Flush/Extended 	Momentary	HW1L-M0	HW4L-M0
	Maintained	HW1L-A0	HW4L-A0
Extended with Full Shroud 	Momentary	HW1L-MF0	HW4L-MF0
	Maintained	HW1L-AF0	HW4L-AF0
Ø 40mm Mushroom Head 	Momentary	HW1L-M0L	HW4L-M0L
	Maintained	HW1L-A0L	HW4L-A0L
Square Flush 	Momentary	HW2L-M0	-
	Maintained	HW2L-A0	

② Lens/LED Color Code

Color	Code
Amber	A
Green	G
Red	R
Blue	S
White	W
Yellow	Y*

- *ALW4BLU not available in yellow.

Illuminated Pushbuttons (Sub-Assembled) con't



Part Numbers: Anti-Rotation Ring

Appearance	Part Number
	HW9Z-RL



Use with notched panel cutout to prevent unit rotation





Part Numbers: Lamps

Type	Voltage	Part Number
LED 	6V AC/DC	LSTD-6②
	12V AC/DC	LSTD-1②
	24V AC/DC	LSTD-2②
	120V AC	LSTD-H2②
Incandescent 	240V AC	LSTD-M4②
	6.3V AC/DC	IS-6
	12V AC/DC	IS-12
	24V AC/DC	IS-24
	30V AC/DC	IS-30

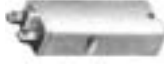

- In place of ②, specify the LED Color Code from table on previous page.
- The LED contains a current-limiting resistor and reverse polarity protection diodes.





Part Numbers: Lamp Circuit Components

Style	Description	Terminals	Part Number
Lead Holder 	For use with HW-CBL on all illuminated pushbutton units. One required for each deck (pair) of contacts.		HW-LH3
Dummy Block with Full Voltage Adaptor 	For use with odd number of contacts.	Fingersafe	HW-DA1FB
		Exposed	HW-DA1B
		Spring Up	HW-GA1
Full Voltage Adaptor 	For use with even number of contacts.	Fingersafe	TW-DA1FB
		Exposed	TW-DA1B
Transformer Unit 	120VAC 240VAC 480VAC	Fingersafe	TW-F126B TW-F246B TW-F486B
	120V 240V 480V	Spring Up	HW-T126 HW-T246 HW-L486
	(6V secondary voltage)	Exposed	TW-T126B TW-T246B TW-T486B
DC-DC Converter	110VDC		HW-L16D



HW-GA1 "Dummy Block with full voltage adaptor" does not require the use of HW-LH3.

Part Numbers: Contact Blocks

Description	Part Number	
	1NO	1NC
Standard Fingersafe (IP20) 	HW-F10 HW-F10R (early make)	HW-F01 HW-F01R (late break)
Spring-Up Terminal Contacts 	HW-G10 HW-G10R (early make)	HW-G01 HW-G01R (late break)
Exposed Screw Terminal Contacts 	HW-C10 HW-C10R (early make)	HW-C01 HW-C01R (late break)
Dummy Block 	TW-DB	



- All assembled part numbers in catalog include standard (HW-F...) contacts.
- Assembled units with spring-up terminals (HW-G...) can be ordered by removing an "F" from the part number (Ex. HW1B-M1F11-R becomes HW1B-M111-R).
- Units with exposed screw terminals (HW-C...) must be ordered as sub-components.

Part Numbers: Contact Block Mounting Adaptor (safety lever lock included)

Style	Part Number
	HW-CBL



- Used to mount contact blocks to operator (first pair only). Lamp holder is built-in.
- IDEC strongly recommends using the safety lever lock (included) to prevent heavy vibration or maintenance personnel from unlocking contacts.

A3

Switches & Pilot Devices

Selector Switches (Assembled)

Part Numbers: 2-Position Selector Switches

Contact	Mounting	Operator Position		Handle	Maintained	Spring Return from Right
		L	R			
					Part Number	Part Number
1NO	1	0	X	Knob Lever	HW ^⑤ S-2TF10 HW ^⑤ S-2LF10	HW ^⑤ S-21TF10 HW ^⑤ S-21LF10
1NO-1NC	1 2	0 X	X 0	Knob Lever	HW ^⑤ S-2TF11 HW ^⑤ S-2LF11	HW ^⑤ S-21TF11 HW ^⑤ S-21LF11
2NO	1 2	0 0	X X	Knob Lever	HW ^⑤ S-2TF20 HW ^⑤ S-2LF20	HW ^⑤ S-21TF20 HW ^⑤ S-21LF20



Part Numbers: 3-Position Selector Switches

Contact	Mounting	Operator Position			Handle	Maintained	Spring Return from Right	Spring Return from Left	Spring Return Two-Way
		L	C	R					
						Part Number	Part Number	Part Number	Part Number
1NO-1NC	1 2	0 0	X 0	X X	Knob Lever	HW ^⑤ S-3TF11 HW ^⑤ S-3LF11	HW ^⑤ S-31TF11 HW ^⑤ S-31LF11	HW ^⑤ S-32TF11 HW ^⑤ S-32LF11	HW ^⑤ S-33TF11 HW ^⑤ S-33LF11
2NO	1 2	X 0	0 0	0 X	Knob Lever	HW ^⑤ S-3TF20 HW ^⑤ S-3LF20	HW ^⑤ S-31TF20 HW ^⑤ S-31LF20	HW ^⑤ S-32TF20 HW ^⑤ S-32LF20	HW ^⑤ S-33TF20 HW ^⑤ S-33LF20
2NO-1NC	1 2 3	X 0 0	0 0 X	0 X 0	Knob	HW ^⑤ S-3JTF21N1	—	—	—
2NO-2NC	1 2 3 4	X 0 0 X	0 0 X X	0 X X 0	Knob	HW ^⑤ S-3TF22	HW ^⑤ S-31TF22	HW ^⑤ S-32TF22	HW ^⑤ S-33TF22

⑤ Bezel Type

Type	Code
Plastic	1
Metal	4

Part Numbers: 4-Position Selector Switch

Contact	Mounting	Operator Position				Handle	Maintained Part Number
		1	2	3	4		
1NO 3NC	1 2 3 4	0 0 0 0	X X 0 0	X 0 X 0	X 0 0 X	Knob Lever	HW ^⑤ S-4TF13N6 HW ^⑤ S-4LF13N6
2NO-2NC	1 2 3 4	X 0 0 0	0 X 0 0	0 0 X 0	0 0 0 X	Knob Lever	HW ^⑤ S-4TF22N3 HW ^⑤ S-4LF22N3

Part Numbers: 5-Position Selector Switch

Contact	Mounting	Operator Position					Handle	Maintained Part Number
		1	2	3	4	5		
2NO-2NC	1 2 3 4	X 0 0 0	0 X 0 0	0 0 0 0	0 0 X 0	0 0 0 X	Knob Lever	HW ^⑤ S-5TF22N3 HW ^⑤ S-5LF22N3



1. In place of ⑤ enter 1 for plastic bezel or 4 for metal bezel.
2. Mounting refers to contact location on operator. See page A3-82.
3. For nameplates, see page A3-96.
4. Custom contact arrangements available. Contact IDEC for details.
5. Five position circuit cannot be made to make five independent contact closures.

Selector Switches (Partial-Assemblies)

Contact Assembly + Operator = Complete Part



A3

Switches & Pilot Devices

Part Numbers: Operators

	No. of Positions	Description	Handle	Plastic Bezel	Metal Bezel
<p>Knob Operator (plastic bezel) Knob Operator (metal bezel)</p> <p>Lever Operator (plastic bezel)</p>	2	Maintained	Knob	HW1S-2T	HW4S-2T
			Lever	HW1S-2L	HW4S-2L
		Spring Return from Right	Knob	HW1S-21T	HW4S-21T
			Lever	HW1S-21L	HW4S-21L
	3	Maintained (standard cam)	Knob	HW1S-3T*	HW4S-3T*
			Lever	HW1S-3L	HW4S-3L
		Maintained (S cam)	Knob	HW1S-3ST*	HW4S-3ST*
		Maintained (J cam)	Knob	HW1S-3JT*	HW4S-3JT*
		Spring Return from Right	Knob	HW1S-31T	HW4S-31T
			Lever	HW1S-31L	HW4S-31L
		Spring Return from Left	Knob	HW1S-32T	HW4S-32T
			Lever	HW1S-32L	HW4S-32L
2-Way Spring Return	Knob	HW1S-33T	HW4S-33T		
	Lever	HW1S-33L	HW4S-33L		
4	Maintained	Knob	HW1S-4T	HW4S-4T	
		Lever	HW1S-4L	HW4S-4L	
5	Maintained	Lever	HW1S-5T	HW4S-5T	
		Lever	HW1S-5L	HW4S-5L	



1. Knob operator includes knob.
2. * Three position operator is available with three different cams.
3. Operator cams are color coded (white=standard cam, red=S cam, black =J cam).
4. For details of determining which cam to use, see page A3-79.

Part Numbers: Contact Assemblies

Style	Contacts	Part Number
Standard Fingersafe Contacts 	1NO 1NC 1NO/1NC 2NO 2NC 2NO/2NC	HW-CBF10 HW-CBF01 HW-CBF11 HW-CBF20 HW-CBF02 HW-CBF22
Spring Up Terminal Contacts 	1NO 1NC 1NO/1NC 2NO 2NC 2NO/2NC	HW-CB10 HW-CB01 HW-CB11 HW-CB20 HW-CB02 HW-CB22

Selector Switches (Sub-Assembled)

Contact Blocks + **Adaptor and Safety Lever Lock** + **Anti-Rotation Ring** + **Operator** = **Complete Part**

A3



Switches & Pilot Devices

Part Numbers: Operators

Style	# of Positions	Description	Handle	Plastic Bezel	Metal Bezel
Knob Operator	2	Maintained	Knob	HW1S-2T	HW4S-2T
			Lever	HW1S-2	HW4S-2
	Spring Return from Right	Knob	HW1S-21T	HW4S-21T	
		Lever	HW1S-21	HW4S-21	
Lever Operator	3	Maintained (standard cam)	Knob	HW1S-3T*	HW4S-3T*
			Lever	HW1S-3*	HW4S-3*
		Maintained (S cam)	Knob	HW1S-3ST*	HW4S-3ST*
		Maintained (J cam)	Knob	HW1S-3JT*	HW4S-3JT*
	Spring Return from Right (standard cam)	Knob	HW1S-31T	HW4S-31T	
		Lever	HW1S-31	HW4S-31	
	Spring Return from Left (standard cam)	Knob	HW1S-32T	HW4S-32T	
		Lever	HW1S-32	HW4S-32	
	2-Way Spring Return (standard cam)	Knob	HW1S-33T	HW4S-33T	
		Lever	HW1S-33	HW4S-33	
4	Maintained	Knob	HW1S-4T	HW4S-4T	
		Lever	HW1S-4	HW4S-4	
5	Maintained	Knob	HW1S-5T	HW4S-5T	
		Lever	HW1S-5	HW4S-5	

Part Numbers: Contact Block Mounting Adaptor (safety lever lock included)

Appearance	Part Number
	HW-CB2C

- Used to mount contact blocks to operator (first pair only).
- IDEC strongly recommends using the safety lever lock (included) to prevent heavy vibration or maintenance personnel from unlocking contacts.

Part Numbers: Contact Blocks

Description	Part Number	
	1NO	1NC
Standard Fingersafe (IP20)	HW-F10 HW-F10R (early make)	HW-F01 HW-F01R (late break)
Spring-Up Terminal Contacts	HW-G10 HW-G10R (early make)	HW-G01 HW-G01R (late break)
Exposed Screw Terminal Contacts	HW-C10 HW-C10R (early make)	HW-C01 HW-C01R (late break)
Dummy Block	TW-DB	

- All assembled part numbers in catalog include standard (HW-F...) contacts.
- Assembled units with spring-up terminals (HW-G...) can be ordered by removing an "F" from the part number (Ex. HW1B-M1F11-R becomes HW1B-M111-R).
- Units with exposed screw terminals (HW-C...) must be ordered as sub-components.

- Knob operator comes with handle.
- * Three position operator is available with three different cams.
- Operator cams are color coded (white=standard cam, red=S cam, black =J cam).
- For details of determining which cam to use, see page A3-79.
- To order colored handle type, knob/lever and inserts must be ordered separately, along with lever operator. See part numbers below.

Part Numbers: Levers and Inserts

Style	Part Number
Knob	ASWHHY-①
Lever	ASWHHL-①
Lever Color Insert	TW-HC1-①

① Handle/Insert Color Code

Color	Code	Color	Code
Black*	B	Red	R
Blue	S	Yellow	Y
Green	G	White†	W

* Lever color inserts not available in black.
† Knob and lever not available in white.

Part Numbers: Anti-Rotation Ring

Appearance	Part Number
	HW9Z-RL

- Use with notched panel cutout to prevent unit rotation.
- Not required when using HW series nameplates. See page A3-96.

Key Switches (Assembled)



A3

Switches & Pilot Devices

Part Numbers: 2-Position Key Switches

Contact	Mounting	Operator Position		Part Number	
		L	R	Maintained	Spring Return from Right
1NO	1	0	X	HW [Ⓢ] K-2AF10	HW [Ⓢ] K-21BF10
1NO-1NC	1	0	X	HW [Ⓢ] K-2AF11	HW [Ⓢ] K-21BF11
	2	X	0		
2NO	1	0	X	HW [Ⓢ] K-2AF20	HW [Ⓢ] K-21BF20
	2	0	X		

Key Removable Option Codes

Code	Description
A	Key retained in NO position (removable in all positions)
B	Key retained in right position only
C	Key retained in left position only
D	Key retained in left and right (3 position only)
E	Key retained in center only (3 position only)
G	Key retained right and center (3 position only)
H	Key retained left and center (3 position only)



For more information on these options, contact your IDEC representative.

Part Numbers: 3-Position Key Switches

Contact	Mounting	Operator Position			Part Number			
		L	C	R	Maintained	Spring Return from Right	Spring Return from Left	Spring Return from Left & Right
1NO-1NC	1	0	X	X	HW [Ⓢ] K-3AF11	HW [Ⓢ] K-31BF11	HW [Ⓢ] K-32CF11	HW [Ⓢ] K-33DF11
	2	0	0	X				
2NO	1	X	0	0	HW [Ⓢ] K-3AF20	HW [Ⓢ] K-31BF20	HW [Ⓢ] K-32CF20	HW [Ⓢ] K-33DF20
	2	0	0	X				
2NO-2NC	1	X	0	0	HW [Ⓢ] K-3AF22	HW [Ⓢ] K-31BF22	HW [Ⓢ] K-32CF22	HW [Ⓢ] K-33DF22
	2	0	0	X				
	3	0	X	X				
	4	X	X	0				

Ⓢ Bezel Type

Type	Code
Plastic	1
Metal	4



- In place of Ⓢ enter 1 for plastic bezel or 4 for metal bezel (see table at right).
- Key is removable in all maintained positions. Other key removable options available.
- Two keys are supplied with all switches.
- All standard operators are keyed alike (contact IDEC for special keys).
- For nameplates, see page A3-96.
- Custom contact arrangements available, contact IDEC for details.
- Mounting refers to contact location on operator. See page A3-82.

Key Switches (Partial-Assemblies)

Contact Assembly + **Operator** = **Complete Part**



A3

Switches & Pilot Devices

Part Numbers: Operators

	# of Positions	Description	Plastic Bezel	Metal Bezel
	2	Maintained	HW1K-2A	HW4K-2A
		Maintained, key remove left only	HW1K-2B	HW4K-2B
		Spring from Right	HW1K-21B	HW4K-21B
	3	Maintained, Standard Cam	HW1K-3A	HW4K-3A
		Maintained, Cam S	HW1K-3SA	HW4K-3SA
		Maintained, Cam J	HW1K-3JA	HW4K-3JA
		Spring Return from Right	HW1K-31B	HW4K-31B
		Spring Return from Left	HW1K-32C	HW4K-32C
		Two-Way Spring Return	HW1K-33D	HW4K-33D



1. Operator includes two keys.
2. All standard operators are keyed alike (contact IDEC for special keys).
3. Other key removable options available. See "Other Key Removable Option Codes" on next page.

Part Numbers: Contact Assemblies

Style	Contacts	Part Number
Standard Fingersafe Contacts 	1NO 1NC 1NO/1NC 2NO 2NC 2NO/2NC	HW-CBF10 HW-CBF01 HW-CBF11 HW-CBF20 HW-CBF02 HW-CBF22
Spring Up Terminal Contacts 	1NO 1NC 1NO/1NC 2NO 2NC 2NO/2NC	HW-CB10 HW-CB01 HW-CB11 HW-CB20 HW-CB02 HW-CB22

Key Removable Option Codes

Code	Description
A	Key retained in NO position (removable in all positions)
B	Key retained in right position only
C	Key retained in left position only
D	Key retained in left and right (3 position only)
E	Key retained in center only (3 position only)
G	Key retained right and center (3 position only)
H	Key retained left and center (3 position only)



1. For more information on these options, contact your IDEC representative.
2. Key retained in all spring-return positions.

Key Switches (Sub-Assembled)

Contact Blocks + Adaptor & Safety Lever Lock + Anti-Rotation Ring + Operator = Complete Part



A3

Switches & Pilot Devices

Part Numbers: Operators

# of Positions	Description	Plastic Bezel	Metal Bezel
2	Maintained	HW1K-2A	HW4K-2A
	Maintained, key remove left only	HW1K-2B	HW4K-2B
	Spring from Right	HW1K-21B	HW4K-21B
3	Maintained, Standard Cam	HW1K-3A	HW4K-3A
	Maintained, Cam S	HW1K-3SA	HW4K-3SA
	Maintained, Cam J	HW1K-3JA	HW4K-3JA
	Spring Return from Right	HW1K-31B	HW4K-31B
	Spring Return from Left	HW1K-32C	HW4K-32C
	Two-Way Spring Return	HW1K-33D	HW4K-33D



- Operator includes two keys.
- All standard operators are keyed alike (contact IDEC for special keys).
- Other key removable options available. See table below.

Part Numbers: Contact Block Mounting Adaptor (safety lever lock included)

Style	Part Number
	HW-CB2C



- Used to mount contact blocks to operator (first pair only).
- IDEC strongly recommends using the safety lever lock (included) to prevent heavy vibration or maintenance personnel from unlocking contacts.

Key Removable Option Codes

Code	Description
A	Key retained in NO position (removable in all positions)
B	Key retained in right position only
C	Key retained in left position only
D	Key retained in left and right (3 position only)
E	Key retained in center only (3 position only)
G	Key retained right and center (3 position only)
H	Key retained left and center (3 position only)



For more information on these options, contact your IDEC representative.

Part Numbers: Contact Blocks

Description	Part Number	
	1NO	1NC
Standard Fingersafe (IP20) 	HW-F10 HW-F10R (early make)	HW-F01 HW-F01R (late break)
Spring-Up Terminal Contacts 	HW-G10 HW-G10R (early make)	HW-G01 HW-G01R (late break)
Exposed Screw Terminal Contacts 	HW-C10 HW-C10R (early make)	HW-C01 HW-C01R (late break)
Dummy Block 	TW-DB	



- All assembled part numbers in catalog include standard (HW-F...) contacts.
- Assembled units with spring-up terminals (HW-G...) can be ordered by removing an "F" from the part number (Ex. HW1B-M1F11-R becomes HW1B-M111-R).
- Units with exposed screw terminals (HW-C...) must be ordered as sub-components.

Part Numbers: Anti-Rotation Ring

Appearance	Part Number
	HW9Z-RL



- Use with notched panel cutout to prevent unit rotation (not included with assembled units).
- Not required when using HW series nameplates. See page A3-96.

Illuminated Selector Switches (Assembled)

A3

Switches & Pilot Devices



Part Numbers: 2-Position LED/Incandescent Selector Switches

Plastic Bezel	Operator Position				Type	Part Number	
	Contact	Mounting	L	R		Maintained	Spring Return From Right
	1NO-1NC	1 2	0	X	Full Voltage	HW ^⑤ F-2F11Q ^④ - ^② - ^③	HW ^⑤ F-21F11Q ^④ - ^② - ^③
			X	0	Transformer	120V HW ^⑤ F-2F11H2 ^④ - ^② 240V HW ^⑤ F-2F11M4 ^④ - ^② 480V HW ^⑤ F-2F11T8 ^④ - ^②	HW ^⑤ F-21F11H2 ^④ - ^② HW ^⑤ F-21F11M4 ^④ - ^② HW ^⑤ F-21F11T8 ^④ - ^②
	2NO	1 2	0	X	Full Voltage	HW ^⑤ F-2F20Q ^④ - ^② - ^③	HW ^⑤ F-21F20Q ^④ - ^② - ^③
			0	X	Transformer	120V HW ^⑤ F-2F20H2 ^④ - ^② 240V HW ^⑤ F-2F20M4 ^④ - ^② 480V HW ^⑤ F-2F20T8 ^④ - ^②	HW ^⑤ F-21F20H2 ^④ - ^② HW ^⑤ F-21F20M4 ^④ - ^② HW ^⑤ F-21F20T8 ^④ - ^②
	2NO-2NC	1 2 3 4	0	X	Full Voltage	HW ^⑤ F-2F22Q ^④ - ^② - ^③	HW ^⑤ F-21F22Q ^④ - ^② - ^③
			X 0 X 0	X 0 X 0	Transformer	120V HW ^⑤ F-2F22H2 ^④ - ^② 240V HW ^⑤ F-2F22M4 ^④ - ^② 480V HW ^⑤ F-2F22T8 ^④ - ^②	HW ^⑤ F-21F22H2 ^④ - ^② HW ^⑤ F-21F22M4 ^④ - ^② HW ^⑤ F-21F22T8 ^④ - ^②



- In place of ^② specify the Lens/LED color code.
- In place of ^③ specify the Full Voltage code.
- In place of ^④ specify Lamp Type code.
- In place of ^⑤ enter 1 for plastic bezel or 4 for metal bezel (see table below).
- For nameplates, see page A3-96.
- For partial and sub-assembly part numbers, see pages A3-76 and A3-77.
- Mounting refers to contact location on operator. See page A3-82.

^② Lens/LED Color Code

Color	Code
Amber	A
Green	G
Red	R
Blue	S
White	W
Yellow	Y

^③ Full Voltage Code

Voltage	Code
6V AC/DC	6V
12V AC/DC	12V
24V AC/DC	24V
120V AC (LED only)	120 V
240V AC (LED only)	240 V

^④ Lamp Type Code

Lamp	Code
Incandescent	Blank
LED	D

^⑤ Bezel Type

Type	Code
Plastic	1
Metal	4

Illuminated Selector Switches (Assembled) con't

Part Numbers: 3-Position LED/Incandescent Selector Switches

Contact	Mounting	Operator Position			Type	Part Number	Part Number	Part Number	Part Number						
		L	C	R											
1NO-1NC	1	0	X	X	Full Voltage	HW5F-3F11Q4-2-3	HW5F-31F11Q4-2-3	HW5F-32F11Q4-2-3	HW5F-33F11Q4-2-3						
	2	0	0	X						Transformer	120V 240V 480V	HW5F-3F11H24-2 HW5F-3F11M44-2 HW5F-3F11T84-2	HW5F-31F11H24-2 HW5F-31F11M44-2 HW5F-31F11T84-2	HW5F-32F11H24-2 HW5F-32F11M44-2 HW5F-32F11T84-2	HW5F-33F11H24-2 HW5F-33F11M44-2 HW5F-33F11T84-2
2NO	1	X	0	0	Full Voltage	HW5F-3F20Q4-2-3	HW5F-31F20Q4-2-3	HW5F-32F20Q4-2-3	HW5F-33F20Q4-2-3						
	2	0	0	X						Transformer	120V 240V 480V	HW5F-3F20H24-2 HW5F-3F20M44-2 HW5F-3F20T84-2	HW5F-31F20H24-2 HW5F-31F20M44-2 HW5F-31F20T84-2	HW5F-32F20H24-2 HW5F-32F20M44-2 HW5F-32F20T84-2	HW5F-33F20H24-2 HW5F-33F20M44-2 HW5F-33F20T84-2
2NC	1	0	X	X	Full Voltage	HW5F-3F02Q4-2-3	HW5F-31F02Q4-2-3	HW5F-32F02Q4-2-3	HW5F-33F02Q4-2-3						
	2	X	X	0						Transformer	120V 240V 480V	HW5F-3F02H24-2 HW5F-3F02M44-2 HW5F-3F02T84-2	HW5F-31F02H24-2 HW5F-31F02M44-2 HW5F-31F02T84-2	HW5F-32F02H24-2 HW5F-32F02M44-2 HW5F-32F02T84-2	HW5F-33F02H24-2 HW5F-33F02M44-2 HW5F-33F02T84-2
2NO-2NC	1	X	0	0	Full Voltage	HW5F-3F22Q4-2-3	HW5F-31F22Q4-2-3	HW5F-32F22Q4-2-3	HW5F-33F22Q4-2-3						
	2	0	0	X						Transformer	120V 240V 480V	HW5F-3F22H24-2 HW5F-3F22M44-2 HW5F-3F22T84-2	HW5F-31F22H24-2 HW5F-31F22M44-2 HW5F-31F22T84-2	HW5F-32F22H24-2 HW5F-32F22M44-2 HW5F-32F22T84-2	HW5F-33F22H24-2 HW5F-33F22M44-2 HW5F-33F22T84-2
	3	0	X	X								4	X	X	
4NO	1	X	0	0	Full Voltage	HW5F-3F40Q4-2-3	HW5F-31F40Q4-2-3	HW5F-32F40Q4-2-3	HW5F-33F40Q4-2-3						
	2	0	0	X						Transformer	120V 240V 480V	HW5F-3F40H24-2 HW5F-3F40M44-2 HW5F-3F40T84-2	HW5F-31F40H24-2 HW5F-31F40M44-2 HW5F-31F40T84-2	HW5F-32F40H24-2 HW5F-32F40M44-2 HW5F-32F40T84-2	HW5F-33F40H24-2 HW5F-33F40M44-2 HW5F-33F40T84-2
	3	X	0	0								4	X	X	
4NC	1	0	X	X	Full Voltage	HW5F-3F04Q4-2-3	HW5F-31F04Q4-2-3	HW5F-32F04Q4-2-3	HW5F-33F04Q4-2-3						
	2	X	X	0						Transformer	120V 240V 480V	HW5F-3F04H24-2 HW5F-3F04M44-2 HW5F-3F04T84-2	HW5F-31F04H24-2 HW5F-31F04M44-2 HW5F-31F04T84-2	HW5F-32F04H24-2 HW5F-32F04M44-2 HW5F-32F04T84-2	HW5F-33F04H24-2 HW5F-33F04M44-2 HW5F-33F04T84-2
	3	0	X	X								4	X	X	

A3

Switches & Pilot Devices



- In place of ② specify the Lens/LED color code.
- In place of ③ specify the Full Voltage code.
- In place of ④ specify Lamp Type code.
- In place of ⑤ enter 1 for plastic bezel or 4 for metal bezel (see table below).
- For nameplates, see page A3-96.
- For partial and sub-assembly part numbers, see pages A3-76 and A3-77.
- Mounting refers to contact location on operator. See page A3-82.

② Lens/LED Color Code

Color	Code
Amber	A
Green	G
Red	R
Blue	S
White	W
Yellow	Y

③ Full Voltage Code

Voltage	Code
6V AC/DC	6V
12V AC/DC	12V
24V AC/DC	24V
120V AC (LED only)	120 V
240V AC (LED only)	240 V

④ Lamp Type Code

Lamp	Code
Incandescent	Blank
LED	D

⑤ Bezel Type

Type	Code
Plastic	1
Metal	4

Illuminated Selector Switches (Partial-Assemblies)

Contact Assembly + Lamp + Operator/Lens = Complete Part



A3

Switches & Pilot Devices

Full Voltage Models

Part Numbers: Operators/Lens

		Type	Plastic	Metal
	2 pos.	Maintained	HW1F-2②	HW4F-2②
		Spring from Right	HW1F-21②	HW4F-21②
	3 pos.	Maintained	HW1F-3②	HW4F-3②
		Spring from Right	HW1F-31②	HW4F-31②
		Spring from Left	HW1F-32②	HW4F-32②
		Spring from Both	HW1F-33②	HW4F-33②

In place of ②, specify the Lens Color Code from table below.

Part Numbers: Lamps

Type	Voltage	Part Number
	6V AC/DC	LSTD-6②
	12V AC/DC	LSTD-1②
	24V AC/DC	LSTD-2②
	120V AC	LSTD-H2②
	240V AC	LSTD-M4②
	6.3V AC/DC	IS-6
	12V AC/DC	IS-12
	24V AC/DC	IS-24

1. In place of ②, specify the LED Color Code from table below.
2. The LED contains a current-limiting resistor and reverse polarity protection diodes.

Part Numbers: Contact Assemblies (order lamp separately)

Style	Contacts	Part Number
	1NO	HW-FL10Q0
	2NO	HW-FL20Q0
	1NO/1NC	HW-FL11Q0
	1NC	HW-FL01Q0
	2NC	HW-FL02Q0

Order lamp separately from table on right.

Transformer Models

Part Numbers: Contact Assemblies (lamp included)

Style	Contacts	Part Number
	1NO	HW-FL10H2-②
	2NO	HW-FL20H2-②
	1NC	HW-FL01H2-②
	1NO/1NC	HW-FL11H2-②
120V AC with LED	1NO	HW-FL10M4-②
	2NO	HW-FL20M4-②
	1NC	HW-FL01M4-②
	1NO/1NC	HW-FL11M4-②
240V AC with LED	1NO	HW-FL10T8-②
	2NO	HW-FL20T8-②
	1NC	HW-FL01T8-②
	1NO/1NC	HW-FL11T8-②
480V AC with LED	1NO	HW-FL10H2
	2NO	HW-FL20H2
	1NC	HW-FL01H2
	1NO/1NC	HW-FL11H2
120V AC with Incandescent	1NO	HW-FL10M4
	2NO	HW-FL20M4
	1NC	HW-FL01M4
	1NO/1NC	HW-FL11M4
240V AC with Incandescent	1NO	HW-FL10M4
	2NO	HW-FL20M4
	1NC	HW-FL01M4
	1NO/1NC	HW-FL11M4

6V LED/Lamp included with transformer sub-assembly.

Part Numbers: Operators/Lens

		Type	Plastic	Metal
	2 pos.	Maintained	HW1F-2②	HW4F-2②
		Spring from Right	HW1F-21②	HW4F-21②
	3 pos.	Maintained	HW1F-3②	HW4F-3②
		Spring from Right	HW1F-31②	HW4F-31②
		Spring from Left	HW1F-32②	HW4F-32②
		Spring from Both	HW1F-33②	HW4F-33②

In place of ②, specify the Lens Color Code from table below.

② Lens/LED Color Code

Color	Code
Amber	A
Green	G
Red	R
Blue	S
White	W
Yellow	Y

Illuminated Selector Switches (Sub-Assembled)

Transformer * + Contact Blocks + Lead Holder + Adaptor + Lamp + Anti-Rotation + Operator + Illuminated Knob = Complete Part



* not applicable for full voltage units

Part Numbers: Operators

Appearance	# of Positions	Description	Plastic Bezel	Metal Bezel
	2	Maintained	HW1F-2	HW4F-2
		Spring return from right	HW1F-21	HW4F-21
	3	Maintained	HW1F-3	HW4F-3
		Spring return from right	HW1F-31	HW4F-31
		Spring return from left	HW1F-32	HW4F-32
		Two-way spring return	HW1F-33	HW4F-33



Illuminated knobs must be ordered separately.

Part Numbers: Illuminated Knob

Appearance	Description	Part Number
	Amber	HW9Z-FDY-A
	Green	HW9Z-FDY-G
	Red	HW9Z-FDY-R
	Blue	HW9Z-FDY-S
	White	HW9Z-FDY-W
	Yellow	HW9Z-FDY-Y

Part Numbers: Contact Block Mounting Adaptor (safety lever lock included)

Style	Part Number
	HW-CBL



- Used to mount contact blocks to operator (first pair only). Lamp holder is built-in.
- IDEC strongly recommends using the safety lever lock (included) to prevent heavy vibration or maintenance personnel from unlocking contacts.

Part Numbers: Contact Blocks

Description	Part Number	
	1NO	1NC
Standard Fingersafe (IP20) 	HW-F10 HW-F10R (early make)	HW-F01 HW-F01R (late break)
Spring-Up Terminal Contacts 	HW-G10 HW-G10R (early make)	HW-G01 HW-G01R (late break)
Exposed Screw Terminal Contacts 	HW-C10 HW-C10R (early make)	HW-C01 HW-C01R (late break)
Dummy Block 	TW-DB	





- All assembled part numbers in catalog include standard (HW-F...) contacts.
- Assembled units with spring-up terminals (HW-G...) can be ordered by removing an "F" from the part number (Ex. HW1B-M1F11-R becomes HW1B-M111-R).
- Units with exposed screw terminals (HW-C...) must be ordered as sub-components.

A3

Switches & Pilot Devices

Illuminated Selector Switches (Sub- Assembled) con't



Part Numbers: Lamps

Type	Voltage	Part Number
 LED	6V AC/DC	LSTD-6②
	12V AC/DC	LSTD-1②
	24V AC/DC	LSTD-2②
	120V AC	LSTD-H2②
	240V AC	LSTD-M4②
 Incandescent	6.3V AC/DC	IS-6
	12V AC/DC	IS-12
	24V AC/DC	IS-24



1. In place of ②, specify the LED Color Code from table at right.
2. The LED contains a current-limiting resistor and reverse polarity protection diodes.

Part Numbers: Lamp Circuit Components

Style	Description	Terminals	Part Number
 Lead Holder	For use with HW-CBL on all illuminated pushbutton units. One required for each deck (pair) of contacts.		HW-LH3
 Dummy Block with Full Voltage Adaptor	For use with odd number of contacts.	Fingersafe	HW-DA1FB
		Exposed	HW-DA1B
		Spring Up	HW-GA1
 Full Voltage Adaptor	For use with even number of contacts.	Fingersafe	TW-DA1FB
		Exposed	TW-DA1B



HW-GA1 "Dummy Block with full voltage adaptor" does not require the use of HW-LH3.

Part Numbers: Transformer Unit

Style	Voltage	Part Number	
Fingersafe	120V AC 240V AC 480V AC	TW-F126B TW-F246B TW-F486B	
Spring Up	 (6V secondary voltage)	HW-T126 HW-T246 HW-L486	
DC-DC Converter		110VDC	HW-L16D



1. DC-DC converter features spring-up terminals.
2. Applicable voltage range 90-140V DC.

② LED Color Code

Color	Code
Amber	A
Green	G
Red	R
Blue	S
White	W
Yellow	Y

Part Numbers: Anti-Rotation Ring

Appearance	Part Number
	HW9Z-RL



1. Use with notched panel cutout to prevent unit rotation.
2. Not required when using HW series nameplates See page A3-96.

Custom Selector Switch Building Guide

To build a custom selector switch, follow these steps.

Step 1: How many positions of the switch are needed?

of positions
(2, 3, 4, 5)

Step 2: How many contacts should there be?

of isolated contacts
(maximum 6)

Step 3: Fill in the Truth Table

(X = closed, 0 = open)

		Knob Position				
		1	2	3	4	5
C o n t a c t s	1					
	2					
	3					
	4					
	5					
	6					

Step 4: If building a 2, 4, or 5 position selector, skip this step. (2, 4, 5 position selectors have only one cam)

If building a 3 position selector, determine appropriate cam as follows:

Look at Row 1 from above table and locate an identical row in the operator truth tables (See next page).

Repeat for all rows. Find one operator that contains all rows from above table.

Record the operator cam version.

Operator CAM Version
(blank, S, J for 3 position)

Step 5: Build by placing appropriate contact in appropriate mounting position for each desired row on operator cam truth table. "L" and "R" refer to mounting on left or right side of operator as viewed from the front of the panel.

Caution: Before putting any custom selector switch into use, it should be tested using an ohmmeter.



For Operator Truth Tables, see next page.

Operator Truth Tables

Use the following tables to build custom selector switches.

2 Position Selector Switches

Contact	Mounting Position	Operator Position	
		Left	Right
HW-F10 (NO)	L	0	X
	R	0	X
HW-F01 (NC)	L	X	0
	R	X	0
HW-F10R NO-(EM)	L	0	X
	R	0	X
HW-F01R NC-(LB)	L	X	0
	R	X	0



1. Mounting position indicates which side of operator each contact should be mounted (as viewed from the front of the panel).
2. * for key removable code (see page A3-73).

HW1S-2T
HW1K-2*
HW1F-2

3 Position Selector Switches

Contact	Mounting Position	Operator Position		
		Left	Center	Right
HW-F10 (NO)	L	X	0	0
	R	0	0	X
HW-F01 (NC)	L	0	X	X
	R	X	X	0
HW-F10R NO-(EM)	L	X	0	0
	R	0	0	X
HW-F01R NC-(LB)	L	0	X	X
	R	X	X	0



1. HW1S-3T is identified by white plungers on the operator.
2. Mounting position indicates which side of operator each contact should be mounted (as viewed from the front of the panel).
3. * for key removable code (see page A3-73).

HW1S-3T
HW1K-3*
HW1F-3

Contact	Mounting Position	Operator Position		
		Left	Center	Right
HW-F10 (NO)	L	X	0	0
	R	0	0	X
HW-F01 (NC)	L	0	0	X
	R	X	0	0
HW-F10R NO-(EM)	L	X	X	0
	R	0	X	X
HW-F01R NC-(LB)	L	0	X	X
	R	X	X	0



1. HW1S-3ST is identified by red plungers on the operator.
2. Mounting position indicates which side of operator each contact should be mounted (as viewed from the front of the panel).
3. * for key removable code (see page A3-73).

HW1S-3ST
HW1K-3S*

Contact	Mounting Position	Operator Position		
		Left	Center	Right
HW-F10 (NO)	L	X	0	0
	R	0	0	X
HW-F01 (NC)	L	0	X	0
	R	0	X	0
HW-F10R NO-(EM)	L	X	0	X
	R	X	0	X
HW-F01R NC-(LB)	L	0	X	X
	R	X	X	0



1. HW1S-3JT is identified by black plungers on the operator.
2. Mounting position indicates which side of operator each contact should be mounted (as viewed from the front of the panel).
3. * for key removable code (see page A3-73).

HW1S-3JT
HW1K-3J*

A3 Switches & Pilot Devices

Operator Truth Tables con't

4 Position Selector Switches

Contact	Mounting Position	Operator Position			
		1	2	3	4
HW-F10 (NO)	L	X	0	0	0
	R	0	0	0	X
HW-F01 (NC)	L	0	0	X	0
	R	0	X	0	0
HW-F10R NO-(EM)	L	X	X	0	X
	R	X	0	X	X
HW-F01R NC-(LB)	L	0	X	X	X
	R	X	X	X	0

HW1S-4T

5 Position Selector Switches

Contact	Mounting Position	Operator Position				
		1	2	3	4	5
HW-F10 (NO)	L	X	0	0	0	0
	R	0	0	0	0	X
HW-F01 (NC)	L	0	0	0	X	0
	R	0	X	0	0	0
HW-F10R NO-(EM)	L	X	X	X	0	X
	R	X	0	X	X	X
HW-F01R NC-(LB)	L	0	X	X	X	X
	R	X	X	X	X	0

HW1S-5T



Mounting position indicates which side of operator each contact should be mounted (as viewed from the front of the panel).

A3

Switches & Pilot Devices

Custom Selector Switch Building Examples

Example 1: 3 Position, Maintained Selector Switch with 3 Contacts

A3

Determine which operator is capable of producing all the desired contact actions.

	Knob Position			Operator		
	Left	Center	Right	HW1S-3T	HW1S-3ST	HW1S-3JT
Contact 1	0	0	X	Possible with HW-F10 mounted on right	Possible with HW-F10 mounted on right	Possible with HW-F10 mounted on right
Contact 2	0	X	0	Not possible	Not possible	Possible with HW-F01 mounted on left or right
Contact 3	X	0	0	Possible with HW-F10 mounted on left	Possible with HW-F10 mounted on left	Possible with HW-F10 mounted on left

The only operator in this example that will produce all the desired contact actions is HW1S-3JT. Assemble as follows:

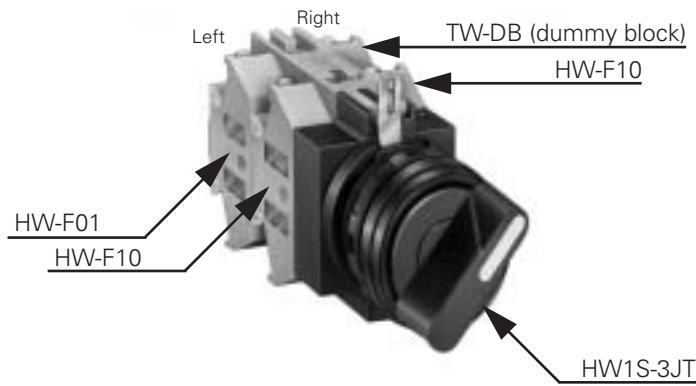

Example 2: 3 Position, Maintained Selector Switch with 2 Contacts

Determine which operator is capable of producing all the desired contact actions.

	Knob Position			Operator		
	Left	Center	Right	HW1S-3T	HW1S-3ST	HW1S-3JT
Contact 1	0	0	X	Possible with HW-F10 mounted on right	Possible with HW-F10 mounted on right	Possible with HW-F10 mounted on right
Contact 2	0	X	X	Possible with HW-F01 mounted on left	Possible with HW-F10R mounted on right or HW-F01R mounted on left	Not possible

This arrangement is possible with either the HW1S-3T or HW1S-3ST operator. It is preferred to use the HW1S-3T as this requires only the standard contacts (HW-F10 and HW-F01 and not the early make (HW-F10R) or late break (HW-F01R) contacts). Assemble as follows:

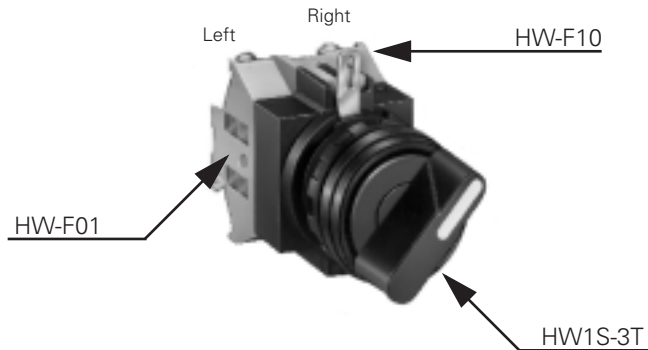

Custom Selector Switch Building Examples con't

Example 3: 4 Position Selector Switch with 4 Contacts

Determine where the contact will be mounted.

	Knob Position				Operator
	1	2	3	4	HW1S-4T
Contact 1	0	X	0	0	HW-F01 mounted on right
Contact 2	0	0	X	0	HW-F01 mounted on left
Contact 3	0	0	0	X	HW-F10 mounted on right
Contact 4	0	X	X	X	HW-F01R mounted on left

Assemble as follows:

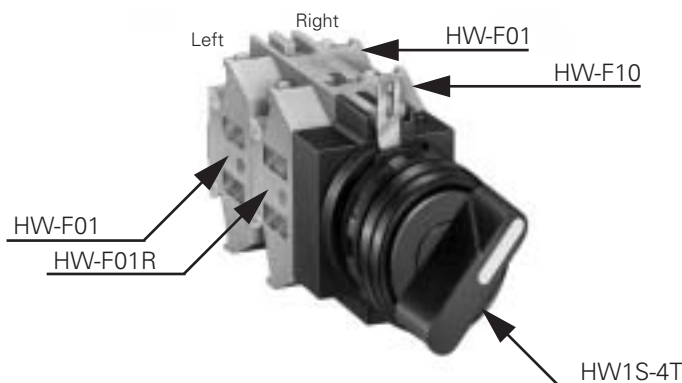

Example 4: 5 Position Selector Switch with 4 Contacts

Determine where the contact will be mounted.

	Knob Position					Operator
	1	2	3	4	5	HW1S-5T
Contact 1	0	X	0	0	0	HW-F01 mounted on right
Contact 2	0	0	0	X	0	HW-F01 mounted on left
Contact 3	0	0	0	0	X	HW-F10 mounted on right
Contact 4	X	0	X	X	X	HW-F10R mounted on right

Assembled as follows:

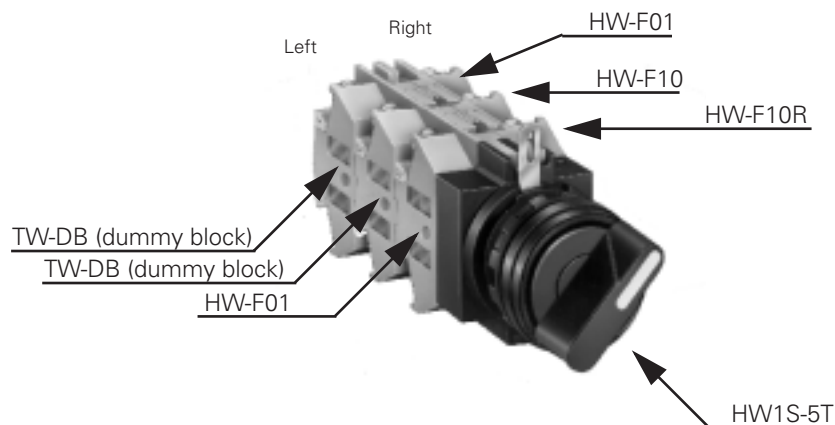

Dual Pushbutton Switches

Two pushbuttons and a pilot light are integrated into one space-saving ø22 mm control unit.

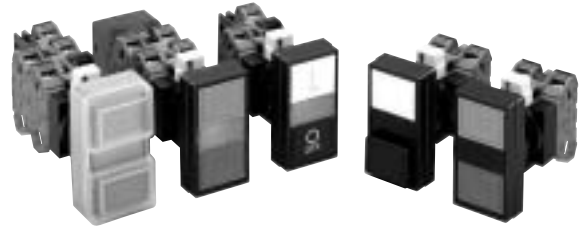

A3

- Momentary and interlock types are available for pushbuttons. Interlock type prevents both buttons from being pressed at the same time.
- Pilot lights are available in full voltage and transformer types illuminated with LED or incandescent lamps.
- IP40 protection, IP65 when using silicon cover.
- UL Listed, CSA approved, and EN compliant



Applications:

- Ideal for use as power switches and start/stop switches (available with I/ON and O/OFF markings on the buttons and a pilot light in the center).
- Interlock type prevents two pushbuttons from being pressed at the same time.

Dual Pushbutton Switches (Assembled)

Part Numbers:

Operation Type	Button Style		Contact Arrangement		Part Number	④ Button Color Code	⑤ Legend Code
			Top Button	Bottom Button			
Momentary	Flush (top) Flush (bottom)		1NO	1NC	HW7D-B11F1001-④⑤	GR: Green (top) Red (bottom) WB: White (top) Black (bottom)	Blank:Without legend 1:I/ON (top) O/OFF (bottom)
			1NO	1NO	HW7D-B11F1010-④⑤		
			1NO-1NC	1NO-1NC	HW7D-B11F1111-④⑤		
			2NO	2NC	HW7D-B11F2002-④⑤		
			2NO	2NO	HW7D-B11F2020-④⑤		
	Flush (top) Extended (bottom)		1NO	1NC	HW7D-B12F1001-④⑤		
			1NO	1NO	HW7D-B12F1010-④⑤		
			1NO-1NC	1NO-1NC	HW7D-B12F1111-④⑤		
			2NO	2NC	HW7D-B12F2002-④⑤		
			2NO	2NO	HW7D-B12F2020-④⑤		
Interlock*	Flush (top) Flush (bottom)		1NO	1NC	HW7D-B21F1001-④⑤		
			1NO	1NO	HW7D-B21F1010-④⑤		
			1NO-1NC	1NO-1NC	HW7D-B21F1111-④⑤		
			2NO	2NC	HW7D-B21F2002-④⑤		
			2NO	2NO	HW7D-B21F2020-④⑤		
	Flush (top) Extended (bottom)		1NO	1NC	HW7D-B22F1001-④⑤		
			1NO	1NO	HW7D-B22F1010-④⑤		
			1NO-1NC	1NO-1NC	HW7D-B22F1111-④⑤		
			2NO	2NC	HW7D-B22F2002-④⑤		
			2NO	2NO	HW7D-B22F2020-④⑤		



1. *Interlock type prevents both top and bottom buttons from being pressed simultaneously.
2. Clear silicon rubber cover part number HW9Z-D7D.

Part Numbers, con't

Part Numbers: With Center Pilot Light

Operation Type	Button Style	Pilot Light Type	Top Button	Bottom Button	Part Number		
 Flush (top) Flush (bottom)	Momentary	Flush (Top) Flush (Bottom)	Full Voltage	1NO	1NC	HW7D-L11F1001 ^{②③-④⑤}	
				1NO	1NO	HW7D-L11F1010 ^{②③-④⑤}	
				1NO-1NC	1NO-1NC	HW7D-L11F1111 ^{②③-④⑤}	
			2NO	2NC	HW7D-L11F2002 ^{②③-④⑤}		
			2NO	2NO	HW7D-L11F2020 ^{②③-④⑤}		
			Transformer	1NO	1NC	HW7D-L11F1001 ^{②③-④⑤}	
		1NO		1NO	HW7D-L11F1010 ^{②③④⑤}		
		1NO-1NC		1NO-1NC	HW7D-L11F1111 ^{②③-④⑤}		
		2NO		2NC	HW7D-L11F2002 ^{②③-④⑤}		
		2NO		2NO	HW7D-L11F2020 ^{②③-④⑤}		
		Flush (Top) Extended (Bottom)		Full Voltage	1NO	1NC	HW7D-L12F1001 ^{②③-④⑤}
			1NO		1NO	HW7D-L12F1010 ^{②③-④⑤}	
	1NO-1NC		1NO-1NC		HW7D-L12F1111 ^{②③-④⑤}		
	2NO		2NC		HW7D-L12F2002 ^{②③-④⑤}		
	2NO		2NO		HW7D-L12F2020 ^{②③-④⑤}		
	Transformer		1NO		1NC	HW7D-L12F1001 ^{②③-④⑤}	
			1NO	1NO	HW7D-L12F1010 ^{②③-④⑤}		
			1NO-1NC	1NO-1NC	HW7D-L12F1111 ^{②③-④⑤}		
			2NO	2NC	HW7D-L12F2002 ^{②③-④⑤}		
			2NO	2NO	HW7D-L12F2020 ^{②③-④⑤}		
			Interlock*	Flush (Top) Flush (Bottom)	Full Voltage	1NO	1NC
	1NO					1NO	HW7D-L21F1010 ^{②③-④⑤}
	1NO-1NC	1NO-1NC				HW7D-L21F1111 ^{②③-④⑤}	
	2NO	2NC				HW7D-L21F2002 ^{②③-④⑤}	
2NO	2NO	HW7D-L21F2020 ^{②③-④⑤}					
Transformer	1NO	1NC				HW7D-L21F1001 ^{②③-④⑤}	
	1NO	1NO			HW7D-L21F1010 ^{②③-④⑤}		
	1NO-1NC	1NO-1NC			HW7D-L21F1111 ^{②③-④⑤}		
	2NO	2NC			HW7D-L21F2002 ^{②③-④⑤}		
	2NO	2NO			HW7D-L21F2020 ^{②③-④⑤}		
	Flush (Top) Extended (Bottom)	Full Voltage			1NO	1NC	HW7D-L22F1001 ^{②③-④⑤}
1NO					1NO	HW7D-L22F1010 ^{②③-④⑤}	
1NO-1NC				1NO-1NC	HW7D-L22F1111 ^{②③-④⑤}		
2NO				2NC	HW7D-L22F2002 ^{②③-④⑤}		
2NO				2NO	HW7D-L22F2020 ^{②③-④⑤}		
Transformer				1NO	1NC	HW7D-L22F1001 ^{②③-④⑤}	
		1NO		1NO	HW7D-L22F1010 ^{②③-④⑤}		
		1NO-1NC		1NO-1NC	HW7D-L22F1111 ^{②③-④⑤}		
		2NO		2NC	HW7D-L22F2002 ^{②③-④⑤}		
		2NO		2NO	HW7D-L22F2020 ^{②③-④⑤}		



- *Interlock type prevents both top and bottom buttons from being pressed simultaneously.
- Clear silicon rubber cover part number HW9Z-D7D.

② Pilot Light Illumination Type and Voltage Code

Full Voltage	
Voltage	Code
6V AC/DC, LED	Q2
12V AC/DC, LED	Q3
24V AC/DC, LED	Q4
120V AC, LED	Q8
6V AC/DC, Incandescent	Q5*
12V AC/DC, Incandescent	Q6*
24V AC/DC, Incandescent	Q7*

Step-Down Transformer (6V Secondary Lamp Voltage)	
Voltage	Code
120V AC, LED	H22
240V AC, LED	M42
480V AC, LED	T82
120V AC, Incandescent	H25*
240V AC, Incandescent	M45*
480V AC, Incandescent	T85*



* Only available for White Lens Pilot Lamp.

③ Pilot Lamp Color Code

Color	Code
Amber	A*
Green	G*
Red	R*
Blue	S*
White	W
Yellow	Y*



* Only available for LED Type illumination.

④ Pushbutton Color Code

Color		Code
Top	Green	GR
Bottom	Red	
Top	White	WB
Bottom	Black	

⑤ Engraving Codes

Engraving	Code	
No Engraving	Blank	
I/ON	Top	1
O/OFF	Bottom	

Contact Arrangement Chart

A3

Switches & Pilot Devices

Contact Arrangement			Contact Block		Top Button		Bottom Button		
Top Button	Bottom Button	Contact Code	Mounting Position	Type	Normal	Push	Normal	Push	
1NO	1NO	1010	1	NO		X			
			2	NO				X	
1NO	1NC	1001	1	NO		X			
			2	NC			X		
1NC	1NO	0110	1	NC	X				
			2	NO				X	
1NC	1NC	0101	1	NC	X				
			2	NC			X		
1NO	2NO	1020	1	NO		X			
			2	NO				X	
			3	Dummy					
			4	NO					X
1NO	1NO-1NC	1011	1	NO		X			
			2	NO				X	
			3	Dummy					
			4	NC			X		
1NO	2NC	1002	1	NO		X			
			2	NC			X		
			3	Dummy					
			4	NC			X		
1NC	2NO	0120	1	NC	X				
			2	NO				X	
			3	Dummy					
			4	NO					X
1NC	1NO-1NC	0111	1	NC	X				
			2	NO				X	
			3	Dummy					
			4	NC			X		
1NC	2NC	0102	1	NC	X				
			2	NC			X		
			3	Dummy					
			4	NC			X		
2NO	1NO	2010	1	NO		X			
			2	NO				X	
			3	NO		X			
			4	Dummy					
2NO	1NC	2001	1	NO		X			
			2	NC			X		
			3	NO		X			
			4	Dummy					
1NO-1NC	1NO	1110	1	NO		X			
			2	NO				X	
			3	NC	X				
			4	Dummy					
1NO-1NC	1NC	1101	1	NO		X			
			2	NO			X		
			3	NC	X				
			4	Dummy					
2NC	1NO	0210	1	NC	X				
			2	NO				X	
			3	NC	X				
			4	Dummy					



1. Transformers can have two or four contact blocks only.
2. Contact blocks 1 and 3 are actuated by the top button. Contact blocks 2 and 4 are actuated by the bottom button.

Contact Arrangement Chart con't

Contact Arrangement			Contact Block		Top Button		Bottom Button	
Top Button	Bottom Button	Contact Code	Mounting Position	Type	Normal	Push	Normal	Push
2NC	1NC	0201	1	NC	X			
			2	NC			X	
			3	NC	X			
			4	Dummy				
2NO	2NO	2020	1	NO		X		
			2	NO				X
			3	NO		X		
			4	NO				X
2NO	1NO-1NC	2011	1	NO		X		
			2	NO				X
			3	NO		X		
			4	NC			X	
2NO	2NC	2002	1	NO		X		
			2	NC			X	
			3	NO		X		
			4	NC			X	
1NO-1NC	2NO	1120	1	NO		X		
			2	NO				X
			3	NC	X			
			4	NO				X
1NO-1NC	1NO-1NC	1111	1	NO		X		
			2	NO				X
			3	NC	X			
			4	NC			X	
1NO-1NC	2NC	1102	1	NO		X		
			2	NC			X	
			3	NC	X			
			4	NC			X	
2NC	2NO	0220	1	NC	X			
			2	NO				X
			3	NC	X			
			4	NO				X
2NC	1NO-1NC	0211	1	NC	X			
			2	NO				X
			3	NC	X			
			4	NC			X	
2NC	2NC	0202	1	NC	X			
			2	NC			X	
			3	NC	X			
			4	NC			X	

Contact Block Mounting Position Example

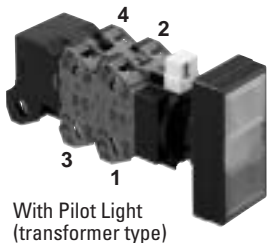

A3

Switches & Pilot Devices

Dual Pushbutton Switches (Sub-Assembled)



Part Numbers: Operators

	Style	Type	Button Style	Part Number
Flush Flush		Momentary	Flush (top) Flush (bottom)	HW7D-011④-⑤
			Flush (top) Extended (bottom)	HW7D-012④-⑤
Flush Extended		Interlock	Flush (top) Flush (bottom)	HW7D-021④-⑤
			Flush (top) Extended (bottom)	HW7D-022④-⑤

④ Pushbutton Color Code

Color	Code
Top: Green Bottom: Red	GR
Top: White Bottom: Black	WB

⑤ Engraving Codes

Engraving	Code
No Engraving	Blank
I/ON Top O/OFF Bottom	1

Part Numbers: Contact Blocks

Description	Part Number	
	1NO	1NC
Standard Fingersafe (IP20)	HW-F10 HW-F10R (early make)	HW-F01 HW-F01R (late break)
Spring-Up Terminal Contacts	HW-G10 HW-G10R (early make) HW-G10-MAU (gold contacts)	HW-G01 HW-G01R (late break) HW-G01-MAU (gold contacts)
Exposed Screw Terminal Contacts	HW-C10 HW-C10R (early make)	HW-C01 HW-C01R (late break)
Dummy Block	TW-DB	



- All assembled part numbers in catalog include standard (HW-F...) contacts. (except unibody)
- Assembled units with spring-up terminals (HW-G...) can be ordered by removing an "F" from the part number (Ex. HW1B-M1F11-R becomes HW1B-M111-R).
- Units with exposed screw terminals (HW-C...) must be ordered as sub-component
- All contacts (including exposed screw) are UL, CSA, and IEC compliant and carry the CE mark.

Part Numbers: Contact Block Mounting Adaptor (safety lever lock included)

Appearance	Part Number
Non-Illuminated 	HW-CB2C
Illuminated (with Pilot Light) 	HW-CBL



- Used to mount contact blocks to operator (first pair only).
- IDEC strongly recommends using the safety lever lock (included) to prevent heavy vibration or maintenance personnel from unlocking contacts.

Part Numbers: Lamps/Lens

	Type	Voltage	Part Number
Lamps	LED 	6V AC/DC	LSTD-6②
		12V AC/DC	LSTD-1②
		24V AC/DC	LSTD-2②
		120V AC	LSTD-H2②
		240V AC	LSTD-M4②
	Incandescent 	6.3V AC/DC	IS-6
	12V AC/DC	IS-12	
	24V AC/DC	IS-24	
	30V AC/DC	IS-30	
Lens	Non-Illuminated 		HW9Z-B7B
	Illuminated 		HW9Z-L7W



- In place of ②, specify the LED Color Code from table on right.
- The LED contains a current-limiting resistor and reverse polarity protection diodes.

Part Numbers: Lamp Circuit Components

Style	Description	Terminals	Part Number
Lead Holder 	For use with HW-CBL on all illuminated pushbutton units. One required for each deck (pair) of contacts.		HW-LH3
Dummy Block with Full Voltage Adaptor 	For use with odd number of contacts.	Fingersafe	HW-DA1FB
		Exposed	HW-DA1B
Full Voltage Adaptor 	For use with even number of contacts.	Fingersafe	TW-DA1FB
		Exposed	TW-DA1B
Transformer Unit (6V secondary voltage) 	120VAC 240VAC 480VAC	Fingersafe	TW-F126B TW-F246B TW-F486B
		Spring Up	HW-T126 HW-T246 HW-L486
			Exposed
DC-DC Converter	110VDC		HW-L16D



HW-GA1 "Dummy Block with full voltage adaptor" does not require the use of HW-LH3.

Part Numbers: Anti-Rotation Ring

Appearance	Part Number
	HW9Z-RL



Use with notched panel cut-out to prevent unit rotation.

LED Color Code

Color	Code	Color	Code
Amber	A	Blue	S
Green	G	White	W
Red	R	Yellow	Y

Mono Lever Switches (Assembled)



Part Number Guide

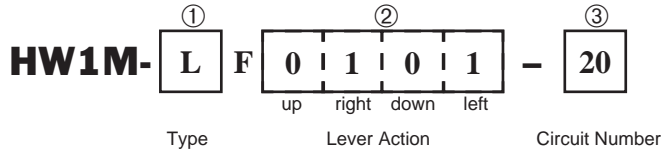

Description	Code	Remarks
① Type	Standard	(blank)
	Interlocking	L
② Lever Action	Maintained	1
	Spring	2
	Blocked	0
③ Circuit Number	20	See Circuit Diagrams below
	40	
	22N9	

Part Numbers: Mono Lever Switches

Description	No. of Positions	Part Number
HW1M Standard Lever	2	HW1M-F1010-20
		HW1M-F2020-20
		HW1M-F0101-20
		HW1M-F0202-20
		HW1M-F0101-40
		HW1M-F0202-40
HW1M-L Interlocking Lever	2	HW1M-LF1010-20
		HW1M-LF2020-20
HW1M-L Interlocking Lever	4	HW1M-LF0101-20
		HW1M-LF0202-20
		HW1M-LF0101-40
		HW1M-LF0202-40
		HW1M-LF1111-22N9
		HW1M-LF2222-22N9

A3

Switches & Pilot Devices

Circuit Diagrams

2 Position Left/Right

Circuit Number	Contact Mounting		Position		
	No.		Left	Center	Right
20	1	HW-F10	X	0	0
	2	HW-F10	0	0	X
40	1	HW-F10	X	0	0
	2	HW-F10	0	0	X
	3	HW-F10	X	0	0
	4	HW-F10	0	0	X

2 Position Up/Down

Circuit Number	Contact Mounting		Position		
	No.		Down	Center	Up
20	1	HW-F10	X	0	0
	2	HW-F10	0	0	X
40	1	HW-F10	X	0	0
	2	HW-F10	0	0	X
	3	HW-F10	X	0	0
	4	HW-F10	0	0	X

3 Position

Circuit Number	Contact Mounting		Position				
	No.		Down	Left	Center	Up	Right
30	1	HW-F01	0	0	0	0	X
	2	HW-F01	X	0	0	0	0
	3	HW-F10	0	X	0	0	0

4 Position

Circuit Number	Contact Mounting		Position				
	No.		Down	Left	Center	Up	Right
22N9	1	HW-F01	0	0	0	0	X
	2	HW-F01	X	0	0	0	0
	3	HW-F10	0	X	0	0	0
	4	HW-F10	0	0	0	X	0

Other circuit arrangements available, contact IDEC for details.

Mono Lever Switches (Sub-Assembled)



Contact Blocks + Mounting Adaptor + Anti-Rotation Ring + Operator = Complete Part



A3

Switches & Pilot Devices

Part Numbers: Operators

Appearance	# of Positions	Description	Part Number
	2	Maintained Up/Down	HW1M-1010
		Spring return Up/Down	HW1M-2020
		Maintained Left/Right	HW1M-0101
		Spring return Left/Right	HW1M-0202
	4	Maintained, 4 position	HW1M-1111
		Spring return, 4 position	HW1M-2222
	2	Maintained Up/Down	HW1M-L1010
		Spring return Up/Down	HW1M-L2020
		Maintained Left/Right	HW1M-L0101
		Spring return Left/Right	HW1M-L0202
	4	Maintained, 4 position	HW1M-L1111
		Spring return, 4 position	HW1M-L2222

Part Numbers: Contact Block Mounting Adaptor (safety lever lock included)

Appearance	Part Number
	HW-CB2C



-  1. Used to mount contact blocks to operator (first pair only).
- 2. IDEC strongly recommends using the safety lever lock (included) to prevent heavy vibration or maintenance personnel from unlocking contacts.

Part Numbers: Anti-Rotation Ring





Appearance	Part Number
	HW9Z-RL

-  1. Use with notched panel cutout to prevent unit rotation.
- 2. Not required when using HW series nameplates See page A3-96.

Part Numbers: Replacement Parts

Item	Part Number
Black Cap 	HW9Z-CPM
Boot 	HW9Z-BLM (fits standard type operator only)

Part Numbers: Contact Blocks

Description	Part Number	
	1NO	1NC
Standard Fingersafe (IP20) 	HW-F10 HW-F10R (early make)	HW-F01 HW-F01R (late break)
Spring-Up Terminal Contacts 	HW-G10 HW-G10R (early make)	HW-G01 HW-G01R (late break)
Exposed Screw Terminal Contacts 	HW-C10 HW-C10R (early make)	HW-C01 HW-C01R (late break)
Dummy Block 	TW-DB	

-  1. All assembled part numbers in catalog include standard (HW-F...) contacts.
- 2. Assembled units with spring-up terminals (HW-G...) can be ordered by removing an "F" from the part number (Ex. HW1B-M1F11-R becomes HW1B-M111-R).
- 3. Units with exposed screw terminals (HW-C...) must be ordered as sub-components.

Pushbutton Selectors (Assembled)

Part Numbers: 2-Position Pushbutton Selectors

Contacts	Mounting		Operator Position				Part Number
			Left		Right		
			Normal	Depressed	Normal	Depressed	
2NO	1	HW-F10	0	X	0	0	HW1R-2DF20-①
	2	HW-F10	0	0	0	X	
2NO-2NC	1	HW-F10	0	X	0	0	HW1R-2DF22N1-①
	2	HW-F10	0	0	0	X	
	3	HW-F01	X	0	X	X	
	4	HW-F01	X	X	X	0	
2NO-2NC	1	HW-F10	0	X	0	0	HW1R-2EF22N1-①
	2	HW-F10	0	0	0	X	
	3	HW-F01	0	0	X	X	
	4	HW-F01	X	X	0	0	
2NO-2NC	1	HW-F10	0	0	0	X	HW1R-2FF22N1-①
	2	HW-F10	0	X	0	0	
	3	HW-F01	0	0	X	0	
	4	HW-F01	X	0	0	0	



A3

Switches & Pilot Devices



1. Available only with momentary pushbutton and maintained selector.
2. In place of ①, specify the button color code from table below
3. Other contact arrangements available. Contact IDEC for details.
4. All assembled parts use flush buttons.
5. **Normal** position refers to the button flush with the selector ring.
6. **Depressed** position refers to the button being pushed in.

① Button Color Code

Color	Code
Black	B
Green	G
Red	R
Blue	S
White	W
Yellow	Y
Grey	N

Pushbutton Selectors (Partial-Assemblies)

Contact Assembly + Operator/Button = Complete Part



A3

Switches & Pilot Devices



Part Numbers: Operators

Appearance	Description	Part Number
	Cam D	HW1R-2D-①
	Cam E	HW1R-2E-①
	Cam F	HW1R-2F-①



In place of ① specify Button Color Code.

Part Numbers: Contact Assemblies

Style	Contacts	Part Number
Standard Fingersafe Contacts 	1NO 1NC 1NO/1NC 2NO 2NC 2NO/2NC	HW-CBF10 HW-CBF01 HW-CBF11 HW-CBF20 HW-CBF02 HW-CBF22
Spring Up Terminal Contacts 	1NO 1NC 1NO/1NC 2NO 2NC 2NO/2NC	HW-CB10 HW-CB01 HW-CB11 HW-CB20 HW-CB02 HW-CB22

① Button Color Code

Color	Code
Black	B
Green	G
Red	R
Blue	S
White	W
Yellow	Y
Grey	N

Pushbutton Selectors (Sub-Assembled)

A3

Switches & Pilot Devices

Contact Blocks + Contact Mounting Adaptor + Anti-Rotation Ring + Operator + Button = Complete Part



Part Numbers: Operators

Appearance	Description	Part Number
	Cam D	HW1R-2D
	Cam E	HW1R-2E
	Cam F	HW1R-2F
	Cam N	HW1R-2N

Part Numbers: Buttons

Description	Part Number
Round Flush 	HW1A-B1-①



In place of ① specify Button Color Code.

Part Numbers: Anti-Rotation Ring

Appearance	Part Number
	HW9Z-RL



1. Use with notched panel cutout to prevent unit rotation.
2. Not required when using HW series nameplates See page A3-96.

Part Numbers: Contact Block Mounting Adaptor (safety lever lock included)

Appearance	Part Number
	HW-CB2C



1. Used to mount contact blocks to operator (first pair only).
2. IDEC strongly recommends using the safety lever lock (included) to prevent heavy vibration or maintenance personnel from unlocking contacts.

Part Numbers: Contact Blocks

Description	Part Number	
	1NO	1NC
Standard Fingersafe (IP20) 	HW-F10 HW-F10R (early make)	HW-F01 HW-F01R (late break)
Spring-Up Terminal Contacts 	HW-G10 HW-G10R (early make)	HW-G01 HW-G01R (late break)
Exposed Screw Terminal Contacts 	HW-C10 HW-C10R (early make)	HW-C01 HW-C01R (late break)
Dummy Block 	TW-DB	



1. All assembled part numbers in catalog include standard (HW-F...) contacts.
2. Assembled units with spring-up terminals (HW-G...) can be ordered by removing an "F" from the part number (Ex. HW1B-M1F11-R becomes HW1B-M111-R).
3. Units with exposed screw terminals (HW-C...) must be ordered as sub-components.

① Button Color Code

Color	Code
Black	B
Green	G
Red	R
Blue	S
White	W
Yellow	Y
Grey	N

Operator Truth Tables

HW Pushbutton Selector Switches - Cam D

A3

Switches & Pilot Devices

Contact	Mounting Position	Operator Position			
		Left ↙		Right ↗	
		Button Free	Button Pressed	Button Free	Button Pressed
HW-F10 (NO)	Left	0	X	0	0
	Right	0	0	0	X
HW-F01 (NC)	Left	X	0	X	X
	Right	X	X	X	0
HW-F10R (NO-EM)	Left	0	X	0	0
	Right	0	0	0	X
HW-F01R (NC-LB)	Left	X	0	X	X
	Right	X	X	X	0

HW Pushbutton Selector Switches - Cam E

Contact	Mounting Position	Operator Position			
		Left ↙		Right ↗	
		Button Free	Button Pressed	Button Free	Button Pressed
HW-F10 (NO)	Left	0	X	0	0
	Right	0	0	0	X
HW-F01 (NC)	Left	0	0	X	X
	Right	X	X	0	0
HW-F10R (NO-EM)	Left	X	X	0	0
	Right	0	0	X	X
HW-F01R (NC-LB)	Left	X	0	X	X
	Right	X	X	X	0

HW Pushbutton Selector Switches - Cam F



Contact	Mounting Position	Operator Position			
		Left ↙		Right ↗	
		Button Free	Button Pressed	Button Free	Button Pressed
HW-F10 (NO)	Left	0	0	0	X
	Right	0	X	0	0
HW-F01 (NC)	Left	0	0	X	0
	Right	X	0	0	0
HW-F10R (NO-EM)	Left	X	X	0	X
	Right	0	X	X	X
HW-F01R (NC-LB)	Left	X	X	X	0
	Right	X	0	X	X

HW Pushbutton Selector Switches - Cam N

Contact	Mounting Position	Operator Position			
		Left ↙		Right ↗	
		Button Free	Button Pressed	Button Free	Button Pressed
HW-F10 (NO)	Left	0	X	0	X
	Right	0	X	0	X
HW-F01 (NC)	Left	0	0	X	0
	Right	X	0	0	0
HW-F10R (NO-EM)	Left	X	X	0	X
	Right	0	X	X	X
HW-F01R (NC-LB)	Left	X	0	X	0
	Right	X	0	X	0

Contactor Reset Button

Part Numbers: Reset Buttons (Assembled)

Appearance	Plastic Bezel	Metal Bezel
 (Blank)	HW1B-M1RS-①T	HW4B-M1RS-①T
 Engraved "R"	HW1B-M1RS-①T-ENG-R	HW4B-M1RS-①T-ENG-R

① Button Color Code

Color	Code
Black	B
Green	G
Grey	N
Red	R
Blue	S
White	W
Yellow	Y

A3

Switches & Pilot Devices



- In place of ① specify Button Color Code.
- 5.1" (130mm) overall length.
- 16mm flat base for easy alignment

Sub-Assemblies

Rod + Operator + Button = Complete Part



Part Numbers: Button

Appearance	Part Number
	HW1A-B1-①



In place of ① specify Button Color Code from table.

Part Numbers: Rod

Appearance	Part Number
	HW9Z-RS-TK2141

① Button Color Code

Color	Code
Black	B
Green	G
Grey	N
Red	R
Blue	S
White	W
Yellow	Y

Part Numbers: Operator

Appearance	Plastic	Metal
	HW1B-M0	
		HW4B-M0

Nameplates — HW Series

Part Numbers: Nameplates

A3

Switches & Pilot Devices

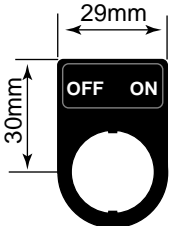
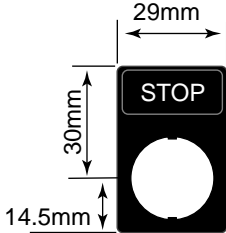
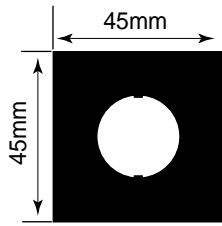
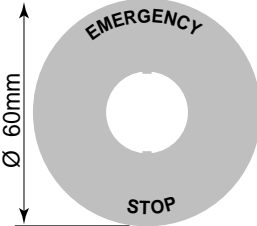
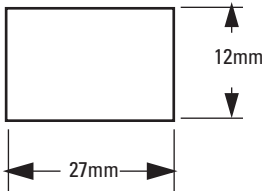
	HWAM—Black Plastic	HWAQ—Black Plastic	HWAS—Black Plastic	HWAV—Yellow Plastic
				
	Part Number	Part Number	Part Number	Part Number
Nameplate (blank engraving plate included)	HWAM-0B	HWAQ-0B	HWAS-0B	HWAV-0
Nameplate (engraved)	HWAM-①	HWAQ-①	HWAS-①	HWAV-27* HWAV5-27†
Additional Insert (blank)	HWNP-0	HWNP-0	HWNP Dimensions	
Additional Insert (engraved)	HWNP-①	HWNP-①		

- 1. In place of ①, insert either the standard legend code from table below or custom engraving delimited by “ ”.
- 2. Standard engravings are available at no charge.
- 3. * HWAV-27 comes engraved “Emergency Stop” as shown in drawing.
- 4. † HWAV5-27 for 80mm diameter jumbo mushroom comes engraved “Emergency Stop” as shown in drawing.

Standard Legend Codes

Pushbuttons				Pushbuttons/Selector Switches				Selector Switches	
Legend	Code	Legend	Code	Legend	Code	Legend	Code	Legend	Code
AUTO	101	OPEN	116	AUTO-MAN	201			AUTO-MAN-OFF	301
CLOSE	102	OUT	117	CLOSE-OPEN	202			AUTO-OFF-MAN	302
DOWN	103	RAISE	118	DOWN-UP	203			CLOSE-OFF-OPEN	303
EMERG.STOP	104	RESET	119	FAST-SLOW	204	REV-FOR	216	DOWN-OFF-SLOW	304
FAST	105	REVERSE	120	FOR-REV	205	RUN-JOG	217	FAST-OFF-SLOW	305
FORWARD	106	RUN	121	HAND-AUTO	206	RUN-SAFE	218	FOR-OFF-REV	306
HAND	107	SLOW	122	HIGH-LOW	207	SAFE-RUN	219	LEFT-OFF-RIGHT	307
HIGH	108	START	123	JOG-RUN	208	SLOW-FAST	220	LOWER-OFF-RAISE	308
IN	109	STOP	125	LEFT-RIGHT	209	START-STOP	221	OFF-MAN-AUTO	309
INCH	110	TEST	126	LOWER-RAISE	210	STOP-START	222	OFF-SLOW-FAST	310
JOG	111	UP	127	MAN-AUTO	211	UP-DOWN	223	OFF-1-2	311
LOW	112	I (Int'l On)	150	OFF-ON	212	OI (Int'l OFF ON)	250	OPEN-OFF-CLOSE	312
LOWER	113	O (Int'l Off)	151	ON-OFF	213			SLOW-OFF-FAST	313
OFF	114	EMO	152	OPEN-CLOSE	214			SUMMER-OFF-WINTER	314
ON	115			RAISE-LOWER	215			UP-OFF-DOWN	315
								1-OFF-2	316
								HAND-OFF-AUTO	317

- 1. To order engraved nameplates, add legend code to nameplate part number.
- 2. Character height based on the number of characters and size of nameplate. Standard character size is 3/16".
- 3. Nameplates with standard legends are the same list price as blank nameplates.
- 4. Nameplates have built-in anti-rotation feature for use with notched panel cut-outs. Additional anti-rotation ring (HW9Z-RL) is not necessary.

Nameplates Order Form — HW Series

Copy this order form and use it to specify Letter Height, Custom Engravings, Location of Engraving on Nameplate, and Quantity Desired. To insure engraving accuracy, fax it to your IDEC representative or Distributor.

Your Company: _____ Name: _____ Telephone: _____ Fax & Email: _____	IDEC Rep/Distributor Contact: _____ PO number (if known): _____ IDEC Rep/Distributor Phone: _____ IDEC Rep/Distributor Fax & Email: _____
--	--

A3

Switches & Pilot Devices

HWAM Nameplate

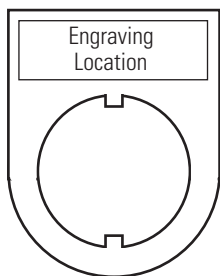

Step 1. Choose Letter Size - 7/64" or 1/8".
 Check the box for the letter size you want. Then write your lettering in box below checkboxes. Note: 1/8" size letters cannot exceed 9 characters.

7/64" Letter Size 11 characters max (for 7/64" size letters)

1/8" Letter Size 9 characters max (for 1/8" size letters)

Step 2. Specify Quantity.
 Enter the number of nameplates desired in the box on the right.

Qty

1	2	3	4	5	6	7	8	9	10	11
---	---	---	---	---	---	---	---	---	----	----

Sample Letter Sizes
 7/64" Letters: A B C D
 1/8" Letters: A B C D

HWAQ Nameplate

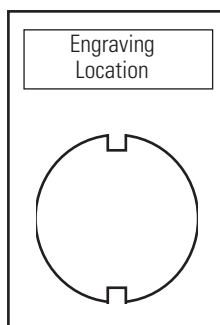

Step 1. Choose Letter Size - 7/64" or 1/8".
 Check the box for the letter size you want. Then write your lettering in box below checkboxes. Note: 1/8" size letters cannot exceed 9 characters.

7/64" Letter Size 11 characters max (for 7/64" size letters)

1/8" Letter Size 9 characters max (for 1/8" size letters)

Step 2. Specify Quantity.
 Enter the number of nameplates desired in the box on the right.

Qty

1	2	3	4	5	6	7	8	9	10	11
---	---	---	---	---	---	---	---	---	----	----

Sample Letter Sizes
 7/64" Letters: A B C D
 1/8" Letters: A B C D

HWAS Nameplate

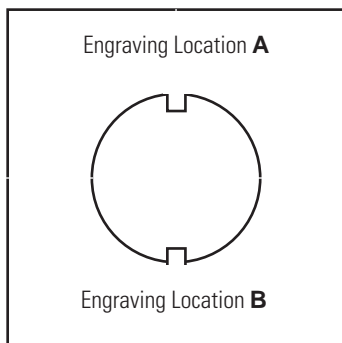

Step 1. Choose Letter Size - 1/8" or 3/32".
 Check the box for the letter size you want. Then write your lettering in box below checkboxes. Note: 1/8" size letters cannot exceed 14 characters.

3/32" Letter Size 20 characters maximum (for 3/32" size letters)

1/8" Letter Size 14 characters maximum (for 1/8" size letters)

Step 2. Specify Quantity.
 Enter the number of nameplates desired in box on the right.

















Qty





Step 3. Specify Location.
 Enter the location of engraving (A or B), in box on the right.

Location

1	2	3	4	5	6	7	8	9	10	11	12	13	14	15	16	17	18	19	20
---	---	---	---	---	---	---	---	---	----	----	----	----	----	----	----	----	----	----	----

Sample Letter Sizes
 3/32" Letters: A B C D
 1/8" Letters: A B C D

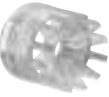
Accessories — HW Series				
	Appearance	Description/Usage	Part Number	
Locking Ring Wrench		Metallic tool used to tighten the plastic locking ring when installing the HW series unit in a panel	MW9Z-T1	
Lamp/LED Removal Tool		Rubber tool makes lamp/LED removal easier.	OR-55	
Anti-Rotation Ring		Prevents rotation of switches in panel. (included with all assembled switches)	for notched panel cutout (standard)	HW9Z-RL
			for round panel cutout	LW9Z-L
Rubber Mounting Hole Plug		Black rubber plug fills unused mounting holes in panel.	OB-31	
Metallic Mounting Hole Plug		For plugging unused mounting holes in the panel. Tighten the attached locking ring to a torque of 12 kfg-cm maximum Degree of protection: IP66	LW9Z-BM	
Barrier		To prevent contact between adjacent lead wires when control units are tightly mounted	HW-VL1	
Pushbutton Clear Boot		Used to cover and protect pushbuttons Operating temperature: -50 to +60°C	Flush Pushbuttons	OC-31
			Extended Pushbuttons	OC-32
Padlock Cover		Plastic hinged cover to protect pushbuttons or selector switches. (Not intended for E-Stops) Degree of protection: IP65	HW9Z-KL1	
Tab Terminal Adapter		Tab #250 (6.35 x 0.8mm): Single tab	TW-FA1	
Adaptor (22mm to 30mm)		Used to mount round HW series control unit (except Jumbo Mushroom, unibody, and square units) into a 30mm panel cut-out. (includes both pieces)	HW9Z-A30	
Replacement Safety Lever Lock		Used to prevent contact mounting lever from moving due to heavy vibration or panel maintenance. (included with all Contact Block Mounting Adaptors)	HWLS-TK1971	
Reset Rod for Contactors Overload		5" rod used with HW1B-M0. See Contactors Section D for more information.	HW9Z-RS-TK2141	
Replacement Operator Washer		Provided with operator. Insert between bezel and locking ring.	HWM-WASHER	
Replacement Locking Ring		Plastic locking nut comes with all HW operators & assemblies.	Standard (plastic)	HW9Z-LN
			Optional (metal)	HW9Z-LNM
Switch Cover (Square)		Used only with round or square flush pushbuttons.	HW9Z-K1 (spring return) HW9Z-K11 (maintained cover)	
Replacement Keys		Pair of Keys (#231)	HW9Z-SKP	

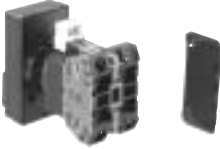
	Appearance	Description/Usage	Part Number
Replacement Lens		HW Illuminated Unibody Replacement Lens	HWLV-LENSR
Replacement Jumbo Dome Lens		Polycarbonate Replacement Lens	HW1A-P5① ① = (A, G, R, S, W, Y)
Replacement Jumbo Diffusing Lens			HW9Z-PP5C
Replacement LED Lamps for HW Jumbo Dome		Replacement LED Lamp	LSTDB-2① ① = (A, G, R, S, W, Y)
Rubber Cover for Dual Pushbuttons		Clear Silicon rubber cover	HW9Z-D7D
Barrier for Dual Pushbuttons		Plastic barrier. Used when mounting the HW7 units on 30mm horizontal centers, to prevent possible interconnections between adjoining terminals.	HW-VG1

Dimensions — HW Series

Non-Illuminated Pushbuttons

A3

Switches & Pilot Devices

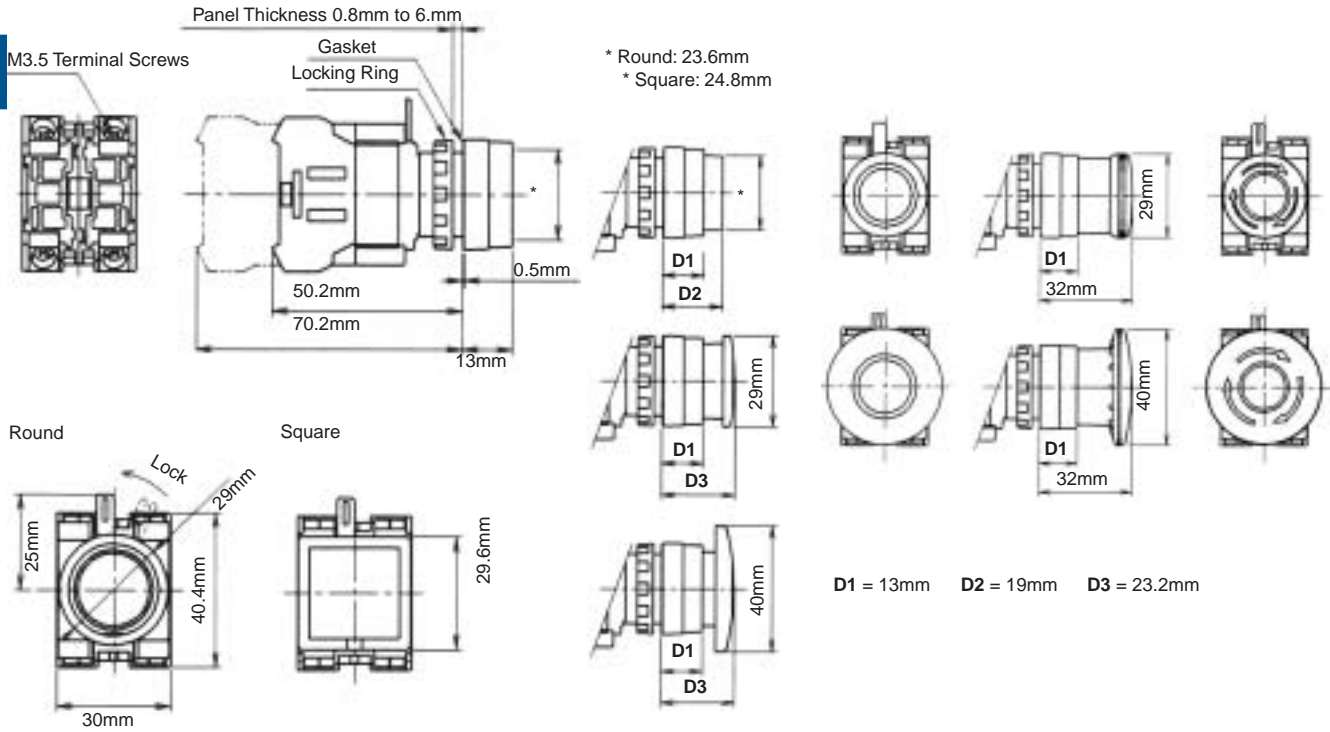

Monolever

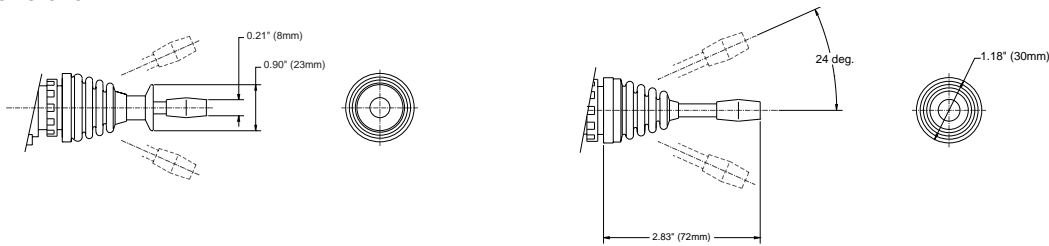

Pilot Lights

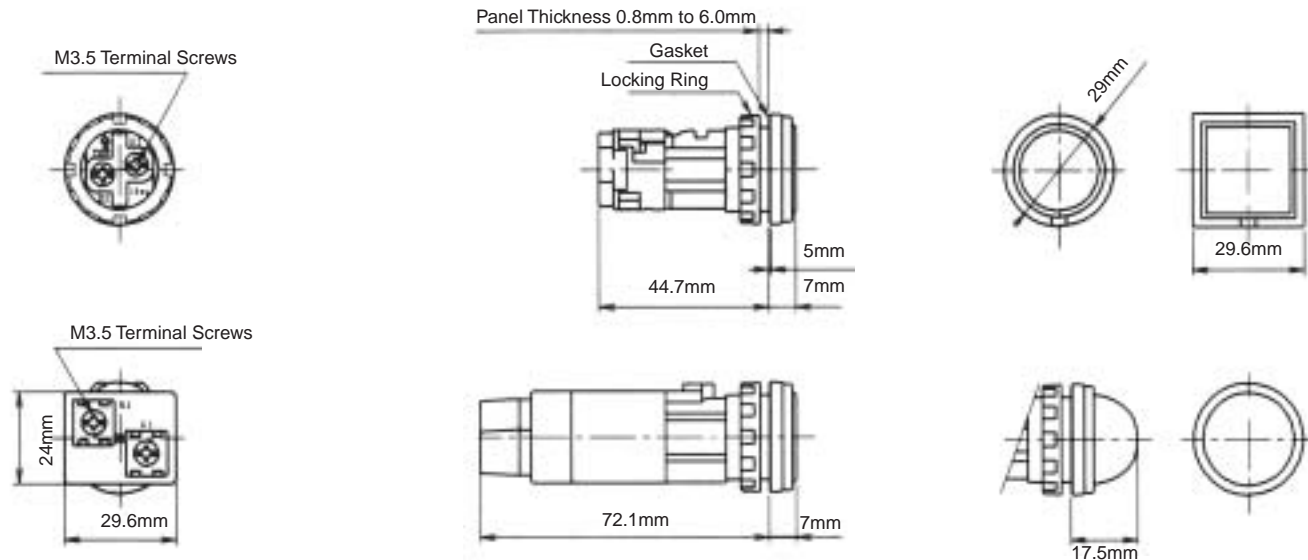

Dimensions con't

Jumbo Mushroom Pushbutton HW1B-M5

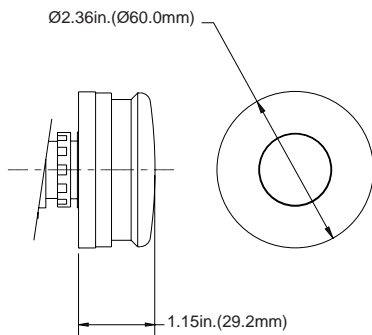

HW1B-V5

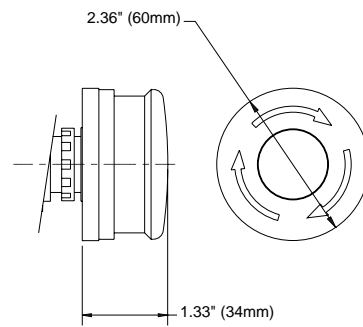

Illuminated Pushbuttons

Panel Thickness: 0.8mm to 6.0mm

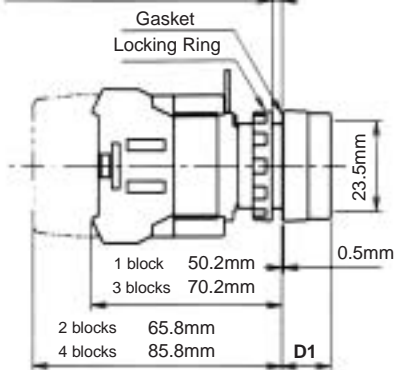

Mushroom

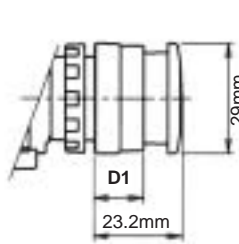

Extended with Full Shroud

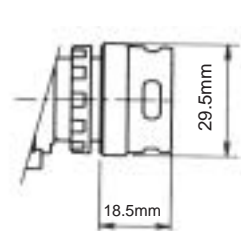

W/Transformer

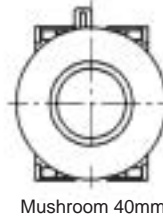
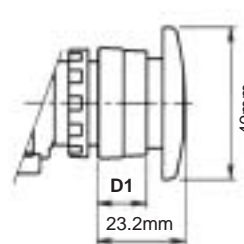
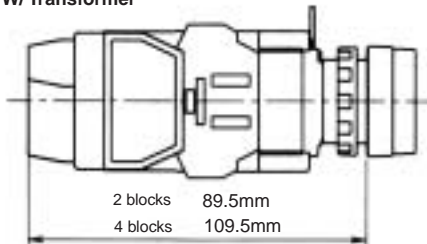

Extended

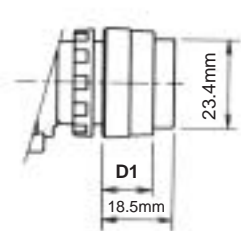

Round

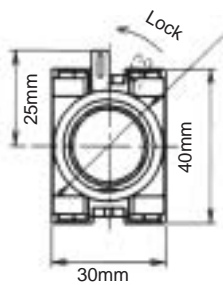

24V AC/DC

M3.5 Terminal Screws
W/ Dummy Block & Full Voltage Adaptor W/ Full Voltage Adaptor

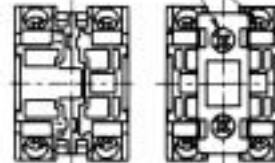

W/Transformer M3.5 Terminal Screws

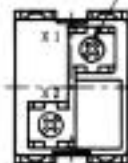

Square

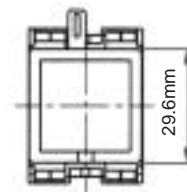

D1 = 0.51" 13mm

Dimensions con't

Unibody

A3

Switches & Pilot Devices

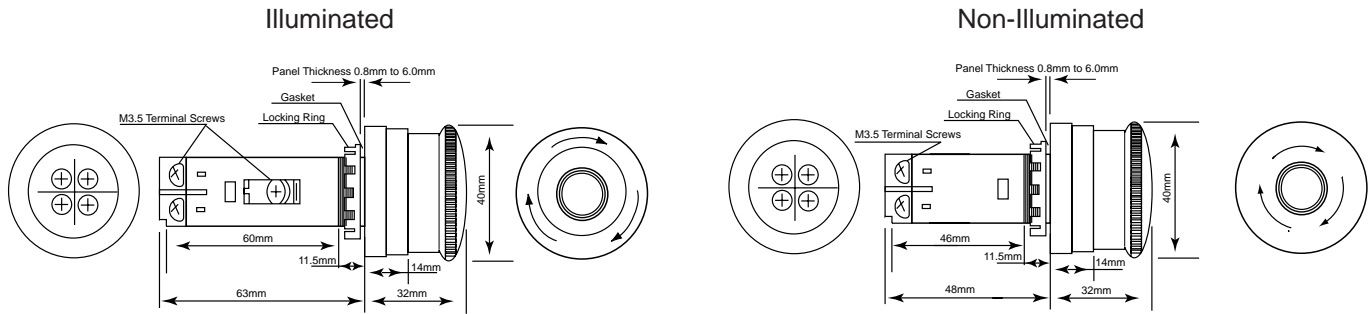

Selector Switches

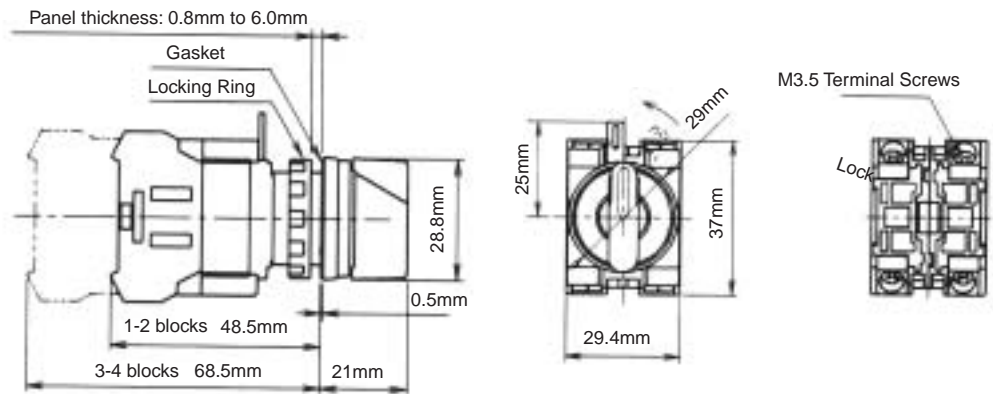

Illuminated Selector Switches

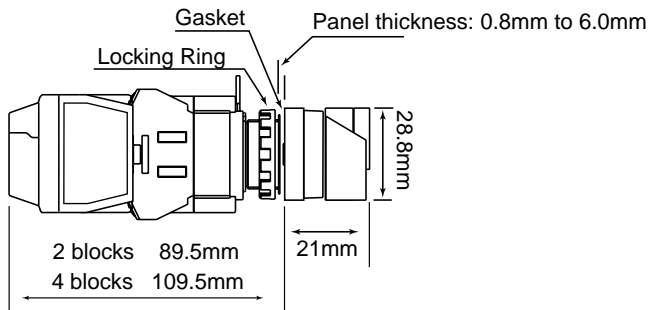

Pushlock Key Reset

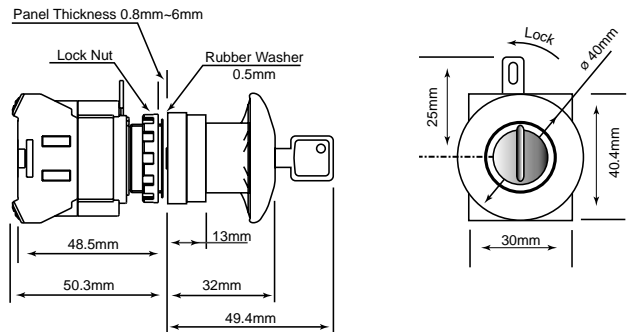

Key Switches

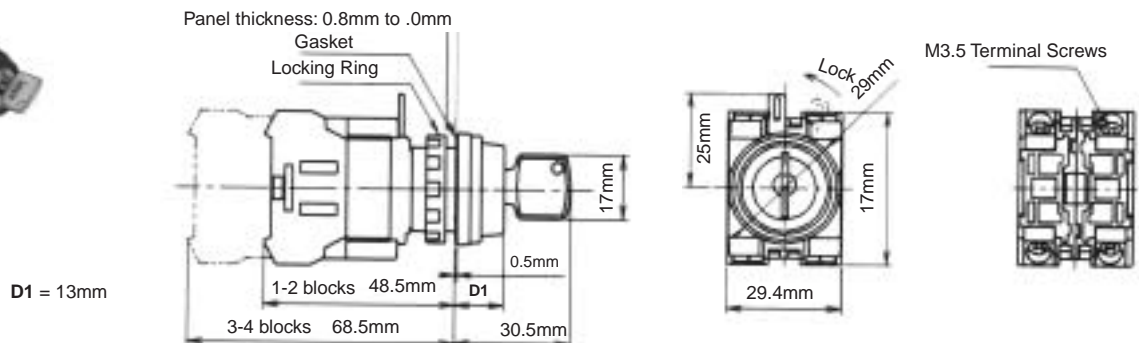

Dimensions con't

Dual Pushbutton Switches

Without Pilot Light

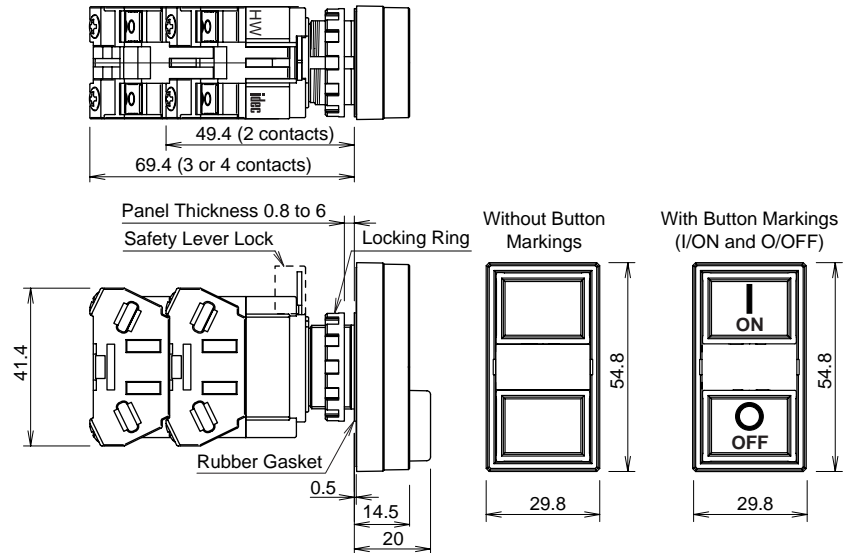

With Pilot Light
• Full Voltage

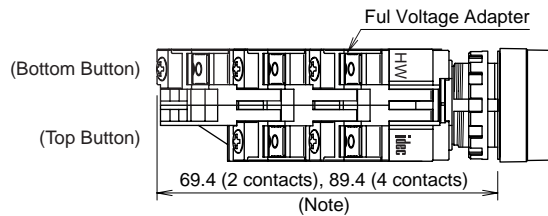

• The depth of 3-contact type depends on the combination of contact blocks at top and bottom pushbuttons.

Top Button	1 contact block	2 contact blocks
Bottom Button	2 contact blocks	1 contact block
Depth	89.4 mm	69.4 mm

• Transformer (240V maximum)

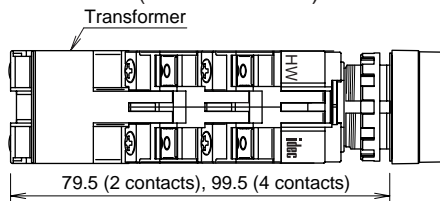

• Transformer (480V)

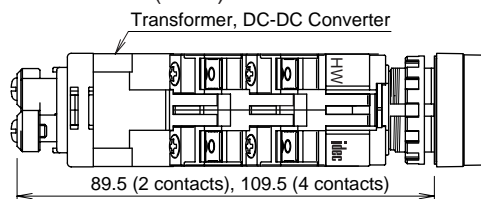

Mounting Hole Layout

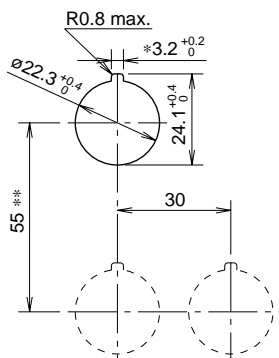

- The 3.2 mm recess is for preventing rotation and is not necessary when a nameplate or anti-rotation ring is not used.
- When using the safety lever lock, determine the vertical spacing in consideration of convenience for installing and removing the safety lever lock.
- Recommended vertical spacing: 100 mm
- The minimum mounting centers are applicable to switches with one layer of contact blocks (two contact blocks). When two layers of contact blocks are mounted, determine the minimum mounting centers in consideration of convenience for wiring.

All dimensions in mm.

A3

Switches & Pilot Devices

A3

Switches & Pilot Devices

Jumbo Dome Pilot Lights

Dimensions

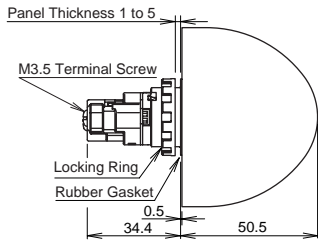

All dimensions in mm.

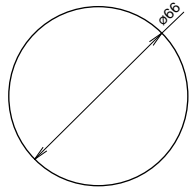

LED Lamp LSTDB

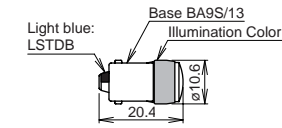

Incandescent Lamp LSB

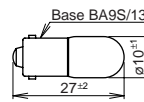

Mounting Hole Layout

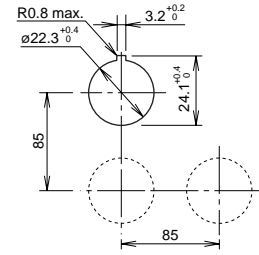

Accessory Dimensions

LW9Z-BM Metallic Mounting Hole Plug

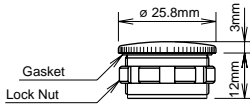

OB-31 Rubber Mounting Hole Plug

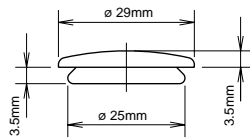

HW9Z-RL Anti-Rotation Ring

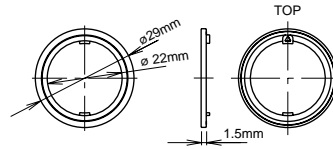

OR-55 Lamp/LED Removal Tool

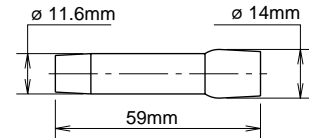

HW9Z-D7D Dual Pushbutton Rubber Cover

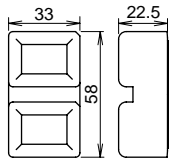

HW-VG1 Dual Pushbutton Barrier

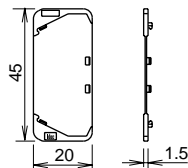

MW9Z-T1 Locking Ring Wrench

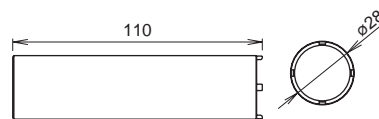

HW9Z-KL1 Padlock Cover

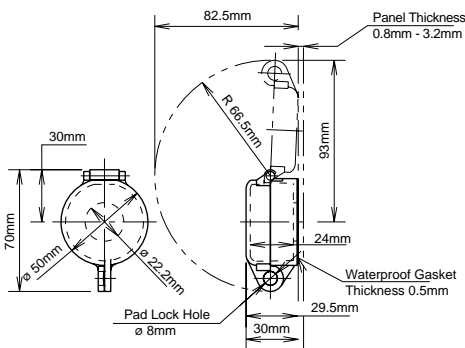

HW-VL1 Barrier

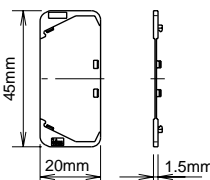

HWLS-TK1971 Safety Lever Lock

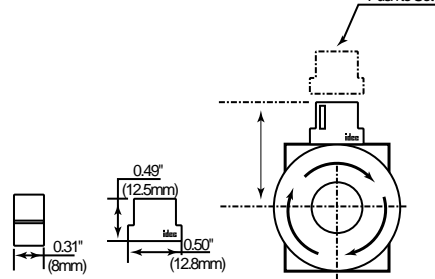

Mounting Hole Layout

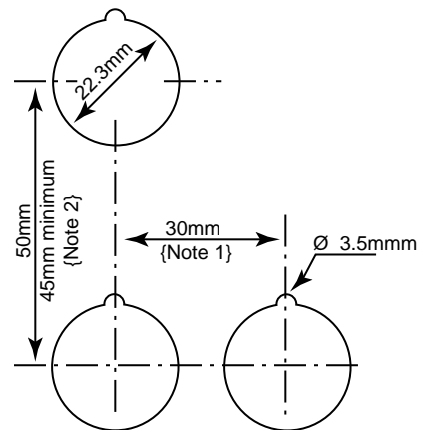

Note 1: Mushroom Button 40mm Type: 40mm or more

Note 2: Pilot Light: 30mm minimum

The values represent the minimum mounting centers when one stack of contact blocks is used. When two stacks or an illuminated unit is used, refer to the dimensions and considering accessibility to determine minimum mounting centers.

Accessory Dimensions con't

HW9Z-KG1-TK2120

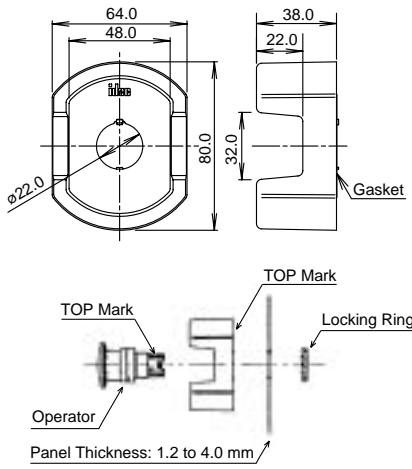

HW9Z-KG2-TK2120

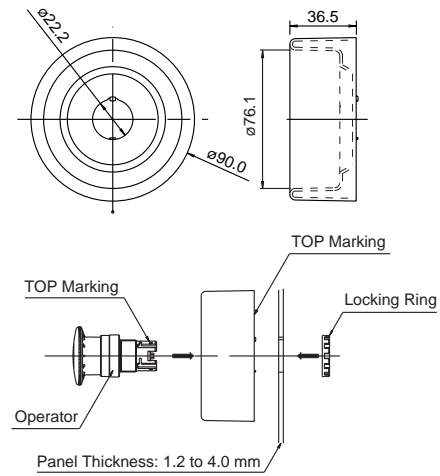

A3

Switches & Pilot Devices

Specification Charts — HW Series

Rated Operational Power DC Voltage

Inductive

DC Voltages

Voltage V	24	48	110
Current A	4	2	1.1

AC Voltages

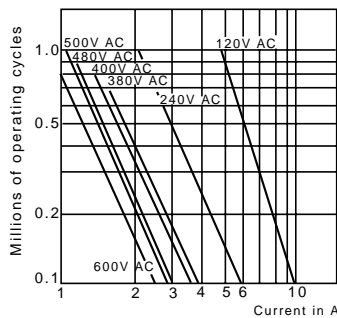

Conforming to IEC 947-5-1 Appendix C.
Utilization categories AC-15 and DC-13.
Operation rate: 1,800 op. hour
Load factor: 0.4 ± 0.05

Resistive

DC Voltages

Voltage V	24	48	110
Current A	8	4	2.2

AC Voltages

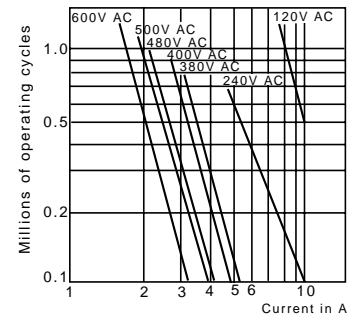

Conforming to IEC 947-5-1 Appendix C.
Utilization categories AC-15 and DC-13.
Operation rate: 1,800 op. hour
Load factor: 0.9 ± 0.05

HW Safety Precautions

HW Series Safety Precautions

- Turn off power to HW series control units before starting installation, removal, wiring, maintenance, and inspection of the products. Failure to turn power off may cause electrical shocks or fire hazard.
- To avoid the possibility of burning yourself, use the lamp holder tool when replacing lamps.

For wiring, use wires of a proper size to meet voltage and current requirements. Tighten the M3.5 terminal screws to a tightening torque of 1.0 to 1.3 N·m. Failure to tighten terminal screws may cause overheating and fire.

HW General Instructions

Panel Mounting

Remove the contact block assembly from the operator (for transformer type pilot lights, remove the transformer from the illumination unit). Remove the locking ring from the operator. Insert the operator into the panel cut-out from the front, tighten the locking ring from the back, then install the contact block assembly to the operator.

Removing and Installing the Contact Block Assembly

1. To remove the operator from the contact block, turn the locking lever in the direction of the arrow shown below. The operator can now be removed.
2. To reinstall, place the TOP markings on the operator and the contact block mounting adapter in the same direction, and insert the operator into the contact block mounting adapter. Then turn the locking lever in the opposite direction.

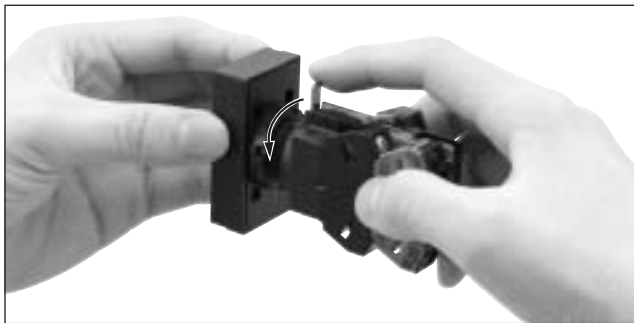

Notes for Panel Mounting

1. When mounting the operator onto a panel, use the optional locking ring wrench (MW9Z-T1) to tighten the locking ring. Tightening torque must not exceed 2.0 N·m. Do not use pliers. Excessive tightening will damage the locking ring.
2. For the contact blocks and transformers housing LED and incandescent lamps, make sure not to press the lamps too hard, otherwise the lamp socket may be damaged.

Safety Lever Lock

IDEC strongly recommends using the safety lever lock (HW9Z-LS, yellow) to prevent heavy vibration or maintenance personnel from unlocking the contact assembly.

1. HW series can be mounted vertically with a minimum spacing of 55 mm but spacing should be determined to ensure easy operation (recommended minimum spacing: 100 mm).
2. Mount the control unit onto the panel, lock the lever, and push in the safety lever lock to install.
3. When the spacing is narrower than the recommended value, with the lever unlocked, mount the safety lever lock and insert the contact unit to the operator. Then, lock the lever and strongly push in the safety lever lock to install.
4. To remove the safety lever lock, insert a flat screwdriver into the safety lever and push upwards.

Removing and Installing the Safety Lever Lock

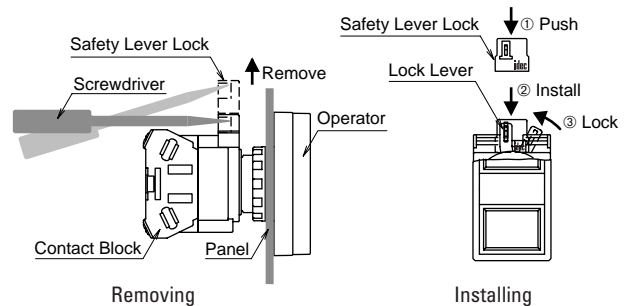

Dual Pushbutton Instructions

Replacement of Lens

Removing

- Remove the lens by inserting a screwdriver into the recess of the lens through the bezel.

Installing

- Install the lens in the recess between the buttons by pressing against the bezel.

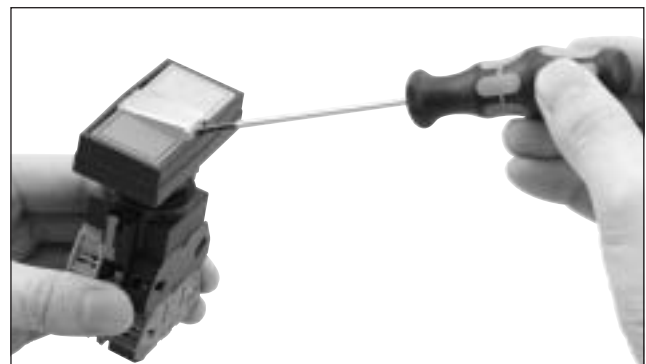

Dual Pushbuttons Instructions con't

Replacement of Lamps

Lamps can be replaced by using the lamp holder tool (OR-55) from the front of the panel, or by removing the contact block assembly from the operator unit.

Removing the Lamps from the Front of the Panel

Removal

1. To remove, slip the lamp holder tool onto the lamp head lightly. Then push slightly, and turn the lamp holder tool counterclockwise.

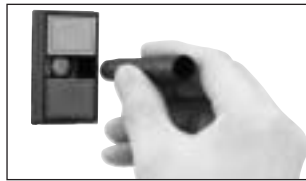

Installation

1. To install, insert the lamp head into the lamp holder tool, and hold the lamp as shown in the figure below.

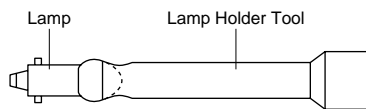

2. Place the pins on the lamp base to the grooves in the lamp socket. Insert the lamp and turn it clockwise.

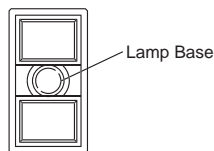

About Pushbutton Switches

The pushbuttons cannot be removed or replaced!

Do not attempt to remove using a flat screwdriver or pincers, otherwise the pushbuttons may be damaged.

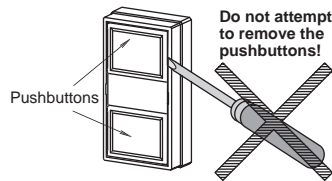

Narrow Mounting

When mounting the units closely in a horizontal row on 30mm centers, use optional barriers to prevent interconnection between adjoining terminals. The barriers can be attached simply by pressing them onto the sides of contact blocks.

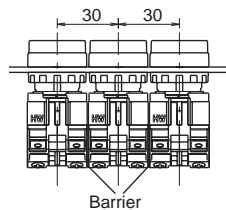
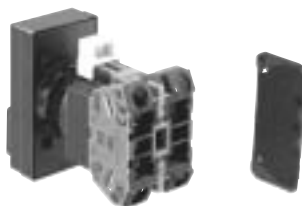

When mounting transformer type illuminated units closely in a horizontal row on 30-mm centers, insert solid wires or stranded wires into inside of the terminal screw on the transformer (see figure on the right) to prevent short circuit between adjoining terminals.

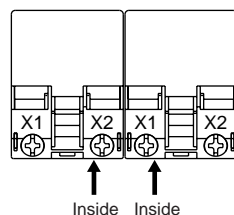

Tightening Torque for Terminal Screws

Tighten the M3.5 terminal screws to a torque of 1.0 to 1.3 N·m.

Installation of LED Illuminated Units

When using full voltage type LED illuminated units, provide protection against electrical noise, if necessary.

Applicable Wiring

The applicable wire size is 2 mm² maximum. (solid wire ø1.6 mm maximum) One or two wires can be connected.

Applicable Crimping Terminal

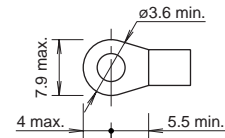

Be sure to use an insulation tube or cover on the crimping part of the terminal to prevent electrical shocks.

Solid Wire

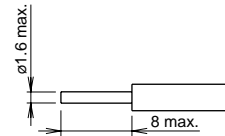

Note: When connecting wires to contact blocks or transformers in the direction shown below, keep the insulation stripping length 6.6 mm at the maximum.

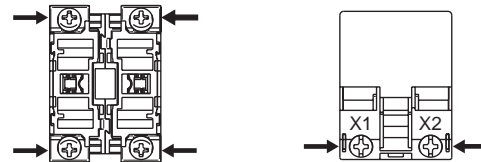

Installing the Rubber Cover

When using the HW7D pushbuttons in places where the pushbuttons are subjected to water splash or an excessive amount of dust, make sure to use the HW9Z-D7D rubber boot (IP65) which is ordered separately.

Notes for Installing the Rubber Cover

Remove the gasket from the operator, and install the rubber boot on the operator. Pull out the seals of the rubber boot and place them around the operator sleeve as shown. Make sure that the seals are not twisted or tucked inside and that the gasket does not remain, otherwise the normal waterproof and dustproof characteristics are not ensured.

- ① Remove the gasket.
- ② Install the rubber boot on the pushbuttons.
- ③ Rubber boot is installed.

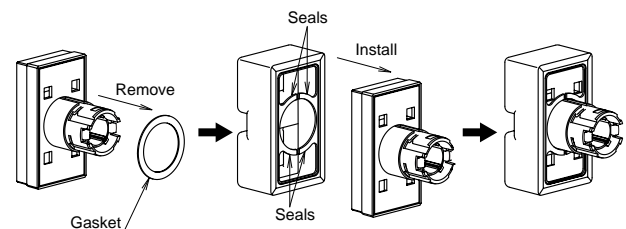

A3

Switches & Pilot Devices



LW Series offer flexibility in space-saving package

Key features include:

- PC board mount, solder or screw terminal
- Collective mounting saves space
- Non-reflective lens
- Highly visible marking plate
- Tamper proof construction
- Light touch reduces strain
- Gold or silver contacts
- Removable contacts simplify wiring and facilitate PCB applications

LW Series switches and pilot lights can be mounted collectively on 1.0" centers. Combined with pcb terminals and locking lever removable contacts, this eases manufacture of pre-fab pushbutton arrays (as pictured). PC Board tracing/soldering of contacts can be done in tandem with panel cutting/operator installation.

All LW series units mount by means of a locking ring that comes on from the rear of the panel, as such they can not be removed from outside the panel and are relatively tamperproof.

Combining the snap action and tactile feel of miniature commercial pushbuttons with the size and ruggedness of industrial pushbuttons, LW pushbuttons are a unique solution to many applications.

Choose from standard silver contacts or low-level gold plated contacts. Terminals available in .110" solder tab, M3 screw, or pcb pins.

Specifications

Specifications	Operating Temperature	-25 to +60°C (without freezing) LED illuminated type: -25 to +50°C		
	Storage Temperature	-40 to +80°C		
	Operating Humidity	45 to 85% RH		
	Contact Resistance	50mΩ maximum (initial value)		
	Insulation Resistance	100MΩ minimum (500V DC megger)		
	Dielectric Strength	Switch Unit	Between live part and ground: 2,500V AC, 1 minute Between terminals of different poles: 2,500V AC, 1 minute Between terminals of the same pole: 1,000V AC, 1 minute	
		Illumination Unit	Between live part and ground: 2,500V AC, 1 minute	
	Vibration Resistance	Operating extremes: 5 to 55Hz, Amplitude 1.0mm p-p		
	Shock Resistance	Damage limits: 1,000 m/sec ² (Approx. 100G) Operating extremes: 100 m/sec ² (Approx. 10G)		
	Mechanical Life	Momentary: 1,000,000 operations minimum Maintained: 500,000 operations minimum Selectors: 250,000 operations minimum		
	Electrical Life	Momentary: 100,000 operations minimum (at 1,800 operations/hour) Maintained/Selector: 100,000 operations minimum (at 900 operations/hour)		
	Degree of Protection	Watertight/oiltight IP65 (IEC Pub529) (except key selectors)		
	Insulation Voltage	250VAC/DC		
	Materials	Lenses	polyarylate	
Operators		polyacetate		
Marking Plates		acrylic resin		
Terminal Style	.110" Solder tab/quick connect PC board terminal (gold contacts only) Screw terminal (DPDT units only)			

A3

Switches & Pilot Devices

Contact Ratings	Contact Material	Thermal Current	Contact Rating	Remarks	
	Gold-clad cross-bar	3A	30VDC/0.1A resistive		Minimum applicable load (reference value): 5V, 1mA AC/DC. (Applicable range is subject to the operating condition and load.)
			125VAC/0.1A resistive		
	Silver Contact	5A	30VDC/2A resistive		
			30VDC/1A inductive		
			125VAC/3A resistive(50/60Hz)		
			125VAC/2A inductive (50/60Hz)		
			125VDC/0.4A resistive		
			125VDC/0.2A inductive		
			250VAC/2A resistive(50/60Hz)		
250VAC/1.5A inductive (50/60Hz)					

Lamp Ratings

	Voltage	Current/Wattage
LED	6V AC/DC ±10%	17mA max
	12V AC/DC ±10%	11mA max
	24V AC/DC ±10%	11mA max
	120V AC ±10%	10mA max
	240V AC ±10%	10mA max
Incandescent	6.3V AC/DC ±5%	1W
	12V AC/DC ±10%	1W
	24V AC/DC ±10%	1W

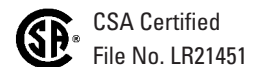





LED lamps contains a built-in current-limiting resistor and reverse polarity protection diode.

Non-Illuminated Pushbuttons (Assembled)

Part Numbers: LW1B/LW2B Pushbuttons

A3

Switches & Pilot Devices

Style	Contact Material	Contact	Part Number					
			Momentary			Maintained (Latching)		
			Solder/Tab	PC Board	Screw	Solder/Tab	PC Board	Screw
 Round Flush	Gold	SPDT	LW1B-M1C1-①	LW1B-M1C1V-①	—	LW1B-A1C1-①	LW1B-A1C1V-①	—
		DPDT	LW1B-M1C2-①	LW1B-M1C2V-①	LW1B-M1C2M-①	LW1B-A1C2-①	LW1B-A1C2V-①	LW1B-A1C2M-①
		3PDT	LW1B-M1C3-①	LW1B-M1C3V-①	—	LW1B-A1C3-①	LW1B-A1C3V-①	—
	Silver	SPDT	LW1B-M1C5-①	—	—	LW1B-A1C5-①	—	—
		DPDT	LW1B-M1C6-①	—	LW1B-M1C6M-①	LW1B-A1C6-①	—	LW1B-A1C6M-①
		3PDT	LW1B-M1C7-①	—	—	LW1B-A1C7-①	—	—
 Square Flush	Gold	SPDT	LW2B-M1C1-①	LW2B-M1C1V-①	—	LW2B-A1C1-①	LW2B-A1C1V-①	—
		DPDT	LW2B-M1C2-①	LW2B-M1C2V-①	LW2B-M1C2M-①	LW2B-A1C2-①	LW2B-A1C2V-①	LW2B-A1C2M-①
		3PDT	LW2B-M1C3-①	LW2B-M1C3V-①	—	LW2B-A1C3-①	LW2B-A1C3V-①	—
	Silver	SPDT	LW2B-M1C5-①	—	—	LW2B-A1C5-①	—	—
		DPDT	LW2B-M1C6-①	—	LW2B-M1C6M-①	LW2B-A1C6-①	—	LW2B-A1C6M-①
		3PDT	LW2B-M1C7-①	—	—	LW2B-A1C7-①	—	—
 Round Extended	Gold	SPDT	LW1B-M2C1-①	LW1B-M2C1V-①	—	LW1B-A2C1-①	LW1B-A2C1V-①	—
		DPDT	LW1B-M2C2-①	LW1B-M2C2V-①	LW1B-M2C2M-①	LW1B-A2C2-①	LW1B-A2C2V-①	LW1B-A2C2M-①
		3PDT	LW1B-M2C3-①	LW1B-M2C3V-①	—	LW1B-A2C3-①	LW1B-A2C3V-①	—
	Silver	SPDT	LW1B-M2C5-①	—	—	LW1B-A2C5-①	—	—
		DPDT	LW1B-M2C6-①	—	LW1B-M2C6M-①	LW1B-A2C6-①	—	LW1B-A2C6M-①
		3PDT	LW1B-M2C7-①	—	—	LW1B-A2C7-①	—	—
 Square Extended	Gold	SPDT	LW2B-M2C1-①	LW2B-M2C1V-①	—	LW2B-A2C1-①	LW2B-A2C1V-①	—
		DPDT	LW2B-M2C2-①	LW2B-M2C2V-①	LW2B-M2C2M-①	LW2B-A2C2-①	LW2B-A2C2V-①	LW2B-A2C2M-①
		3PDT	LW2B-M2C3-①	LW2B-M2C3V-①	—	LW2B-A2C3-①	LW2B-A2C3V-①	—
	Silver	SPDT	LW2B-M2C5-①	—	—	LW2B-A2C5-①	—	—
		DPDT	LW2B-M2C6-①	—	LW2B-M2C6M-①	LW2B-A2C6-①	—	LW2B-A2C6M-①
		3PDT	LW2B-M2C7-①	—	—	LW2B-A2C7-①	—	—
 Mushroom	Gold	SPDT	LW1B-M3C1-①	LW1B-M3C1V-①	—	LW1B-A3C1-①	LW1B-A3C1V-①	—
		DPDT	LW1B-M3C2-①	LW1B-M3C2V-①	LW1B-M3C2M-①	LW1B-A3C2-①	LW1B-A3C2V-①	LW1B-A3C2M-①
		3PDT	LW1B-M3C3-①	LW1B-M3C3V-①	—	LW1B-A3C3-①	LW1B-A3C3V-①	—
	Silver	SPDT	LW1B-M3C5-①	—	—	LW1B-A3C5-①	—	—
		DPDT	LW1B-M3C6-①	—	LW1B-M3C6M-①	LW1B-A3C6-①	—	LW1B-A3C6M-①
		3PDT	LW1B-M3C7-①	—	—	LW1B-A3C7-①	—	—

- 1. In place of ①, specify Button Color Code from table below.
- 2. For sub-assembly part numbers, see page A3-111.
- 3. For dimensions, see page A3-120.
- 4. For accessories, see page A3-119.

Part Numbers: Buzzers (IP20)

Style		Part Number	
		Solder Tab	PCB
	Basic	LW1Z-1X4	LW1Z-1X4V
	With LED	LW1Z-1X4D	LW1Z-1X4DV

 12-24V AC/DC +/- 10%
 80 dB (at 0.1m)
 7mA (DC), 20mA (AC)

① Button Color Code

Color	Code
Black	B
Green	G
Red	R
Blue	S
White	W
Yellow	Y

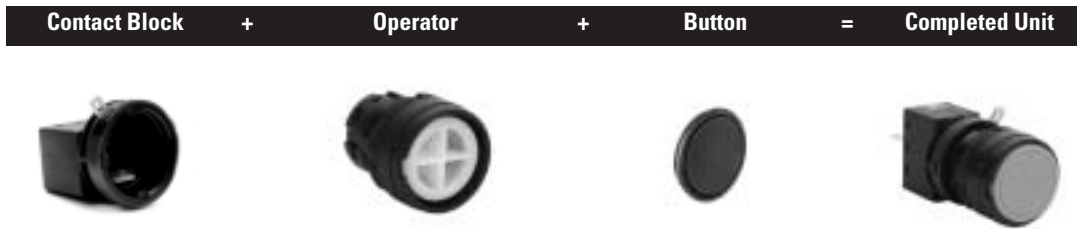

Non-Illuminated Pushbuttons (Sub-Assembled)



Part Numbers: Operators

Style		Part Number	
		Momentary	Maintained
Round		LW1B-M0	LW1B-A0
Square		LW2B-M0	LW2B-A0
Mushroom		LW1B-M0L	LW1B-A0L

Part Numbers: Buttons

Type		Part Number	
		Flush	Extended
Round		LW1A-B1-①	LW1A-B2-①
Square		LW2A-B1-①	LW2A-B2-①
Mushroom		—	LW1A-B3-①

① Button Color Code

Color	Code
Black	B
Green	G
Red	R
Blue	S
White	W
Yellow	Y



In place of ①, specify Button Color Code from table at right.

Part Numbers: Contact Blocks



Appearance	Contact Material	Contact	Part Number		
			Solder/Tab	PC Board	Screw
	Gold	SPDT	LW-C1	LW-C1V	—
		DPDT	LW-C2	LW-C2V	LW-C2M
		3PDT	LW-C3	LW-C3V	—
	Silver	SPDT	LW-C5	—	—
		DPDT	LW-C6	—	LW-C6M
		3PDT	LW-C7	—	—

LED and Incandescent Illuminated Pushbuttons (Assembled)

Part Numbers: LW1L/LW2L Illuminated Pushbuttons (LED and Incandescent)



A3

Switches & Pilot Devices

Style	Contact Material	Contact	Part Number					
			Momentary			Maintained (Latching)		
			Solder/Tab	PC Board	Screw	Solder/Tab	PC Board	Screw
 Round	Gold	SPDT	LW1L-M1C10-②	LW1L-M1C10V-②	—	LW1L-A1C10-②	LW1L-A1C10V-②	—
		DPDT	LW1L-M1C20-②	LW1L-M1C20V-②	LW1L-M1C20M-②	LW1L-A1C20-②	LW1L-A1C20V-②	LW1L-A1C20M-②
		3PDT	LW1L-M1C30-②	LW1L-M1C30V-②	—	LW1L-A1C30-②	LW1L-A1C30V-②	—
	Silver	SPDT	LW1L-M1C50-②	—	—	LW1L-A1C50-②	—	—
		DPDT	LW1L-M1C60-②	—	LW1L-M1C60M-②	LW1L-A1C60-②	—	LW1L-A1C60M-②
		3PDT	LW1L-M1C70-②	—	—	LW1L-A1C70-②	—	—
 Square	Gold	SPDT	LW2L-M1C10-②	LW2L-M1C10V-②	—	LW2L-A1C10-②	LW2L-A1C10V-②	—
		DPDT	LW2L-M1C20-②	LW2L-M1C20V-②	LW2L-M1C20M-②	LW2L-A1C20-②	LW2L-A1C20V-②	LW2L-A1C20M-②
		3PDT	LW2L-M1C30-②	LW2L-M1C30V-②	—	LW2L-A1C30-②	LW2L-A1C30V-②	—
	Silver	SPDT	LW2L-M1C50-②	—	—	LW2L-A1C50-②	—	—
		DPDT	LW2L-M1C60-②	—	LW2L-M1C60M-②	LW2L-A1C60-②	—	LW2L-A1C60M-②
		3PDT	LW2L-M1C70-②	—	—	LW2L-A1C70-②	—	—
 Mushroom	Gold	SPDT	LW1L-M3C10-②	LW1L-M3C10V-②	—	LW1L-A3C10-②	LW1L-A3C10V-②	—
		DPDT	LW1L-M3C20-②	LW1L-M3C20V-②	LW1L-M3C20M-②	LW1L-A3C20-②	LW1L-A3C20V-②	LW1L-A3C20M-②
		3PDT	LW1L-M3C30-②	LW1L-M3C30V-②	—	LW1L-A3C30-②	LW1L-A3C30V-②	—
	Silver	SPDT	LW1L-M3C50-②	—	—	LW1L-A3C50-②	—	—
		DPDT	LW1L-M3C60-②	—	LW1L-M3C60M-②	LW1L-A3C60-②	—	LW1L-A3C60M-②
		3PDT	LW1L-M3C70-②	—	—	LW1L-A3C70-②	—	—

- 1. In place of ②, specify the Lens Color Code from table below.
- 2. Lamps must be ordered separately for all illuminated pushbuttons.
- 3. For marking plate size and engraving area, see page A3-124.
- 4. For sub-assembly part numbers, see page A3-113.
- 5. For dimensions, see page A3-120.
- 5. For accessories, see page A3-119.

Part Numbers: Lamps (not included in assemblies)

Type	Voltage	Part Number
 LED	6V AC/DC±10%	LSTD-6②
	12V AC/DC±10%	LSTD-1②
	24V AC/DC±10%	LSTD-2②
	120V AC±10%	LSTD-H2②
	240V AC ±10%	LSTD-M4②
 Incandescent	6.3V AC/DC	IS-6
	12V AC/DC	IS-12
	24V AC/DC	IS-24

- 1. In place of ②, specify the LED Color Code.
- 2. The LED contains a current-limiting resistor and reverse polarity protection diode.

② Lens/LED Color Code

Color	Code
Amber	A
Green	G
Red	R
Blue	S
White	W
Yellow	Y

LED and Incandescent Illuminated Pushbuttons (Sub-Assembled)

Contact Block + Operator + Lamp + Lens = Completed Unit





A3

Switches & Pilot Devices

Part Numbers: Operators

Style		Part Number	
		Momentary	Maintained
Round		LW1L-M0	LW1L-A0
Square		LW2L-M0	LW2L-A0
Mushroom		LW1B-M0L	LW1B-A0L

Part Numbers: Lenses

Type		Part Number
		Flush
Round		LW1A-L1-②
Square		LW2A-L1-②
Mushroom		LW1A-L3-②





In place of ②, specify Lens Color Code from table below.

Part Numbers: Contact Blocks

Appearance	Contact Material	Contact	Part Number		
			Solder/Tab	PC Board	Screw
	Gold	SPDT	LW-C10	LW-C10V	—
		DPDT	LW-C20	LW-C20V	LW-C20M
		3PDT	LW-C30	LW-C30V	—
	Silver	SPDT	LW-C50	—	—
		DPDT	LW-C60	—	LW-C60M
		3PDT	LW-C70	—	—

Part Numbers: Lamps (not included in assemblies)

Type	Voltage	Part Number
LED 	6V AC/DC±10%	LSTD-6②
	12V AC/DC±10%	LSTD-1②
	24V AC/DC±10%	LSTD-2②
	120V AC±10%	LSTD-H2②
	240V AC ±10%	LSTD-M4②
Incandescent 	6.3V AC/DC	IS-6
	12V AC/DC	IS-12
	24V AC/DC	IS-24

② LED/Lens Color Code

Color	Code
Amber	A
Green	G
Red	R
Blue	S
White	W
Yellow	Y





- In place of ②, specify the LED Color Code.
- The LED contains a current-limiting resistor and reverse polarity protection diode.

LED and Incandescent Pilot Lights (Assembled)

Part Numbers: LW1P/LW2P Pilot Lights



A3

Switches & Pilot Devices

Type	Style	Part Number		
		Solder/Tab	PC Board	Screw
Removable Terminal Pilot Light	Round 	—	LW1P-1C00V-②	—
	Square 	—	LW2P-1C00V-②	—
Unibody Pilot Light	Round 	LW1P-10-②	—	LW1P-10M-②
	Square 	LW2P-10-②	—	LW2P-10M-②

-  1. In place of ②, specify the Lens Color Code from table below.
 2. For marking plate size and engraving area, see page A3-124.
 3. Lamps must be ordered separately, see table below.
 4. For sub-assembly part numbers, see page A3-115.
 5. For dimensions, see page A3-120.
 6. For accessories, see page A3-119.

Part Numbers: Lamps (not included in assemblies)

Type	Voltage	Part Number
LED 	6V AC/DC±10%	LSTD-6②
	12V AC/DC±10%	LSTD-1②
	24V AC/DC±10%	LSTD-2②
	120V AC±10%	LSTD-H2②
	240V AC ±10%	LSTD-M4②
Incandescent 	6.3V AC/DC	IS-6
	12V AC/DC	IS-12
	24V AC/DC	IS-24

② Lens/LED Color Code

Color	Code
Amber	A
Green	G
Red	R
Blue	S
White	W
Yellow	Y

-  1. In place of ②, specify the LED Color Code.
 2. The LED contains a current-limiting resistor and reverse polarity protection diode.

LED and Incandescent Pilot Lights (Sub-Assembled)

A3



Switches & Pilot Devices

Removable Terminal* + Operator + Lamp + Lens = Completed Unit



* Removable terminals are applicable for PCB terminated types only.

Part Numbers: Pilot Light Operators

Style	Termination		
	Solder	PC Board	Screw
Round 	LW1P-00	LW1P-0 †	LW1P-00M
Square 	LW2P-00	LW2P-0 †	LW2P-00M



- † Requires LW-C00V removable terminals in addition to operator.
- Solder and screw terminals are unibody design (they do not use a removable terminal block).



Part Numbers: Lenses

Type	Part Number
Round 	LW1A-P1-②
Square 	LW2A-P1-②



In place of ②, specify Lens Color Code.

Part Numbers: Lamps (not included in assemblies)

Type	Voltage	Part Number
LED 	6V AC/DC±10%	LSTD-6②
	12V AC/DC±10%	LSTD-1②
	24V AC/DC±10%	LSTD-2②
	120V AC±10%	LSTD-H2②
	240V AC ±10%	LSTD-M4②
Incandescent 	6.3V AC/DC	IS-6
	12V AC/DC	IS-12
	24V AC/DC	IS-24





- In place of ②, specify the LED Color Code.
- The LED contains a current-limiting resistor and reverse polarity protection diode.

② LED/Lens Color Code

Color	Code
Amber	A
Green	G
Red	R
Blue	S
White	W
Yellow	Y



Selector and Keylock Switches (Assembled)

Part Numbers: LW1S Selector Switches

Style	Position	Contact Material	Contact	Part Number		
				Solder/Tab	PC Board	Screw
Round 	90° 2-position maintained 	Gold	SPDT	LW1S-2C1	LW1S-2C1V	—
			DPDT	LW1S-2C2	LW1S-2C2V	LW1S-2C2M
			3PDT	LW1S-2C3	LW1S-2C3V	—
		Silver	SPDT	LW1S-2C5	—	—
			DPDT	LW1S-2C6	—	LW1S-2C6M
			3PDT	LW1S-2C7	—	—
	45° 3-position maintained 	Gold	DPDT	LW1S-3C2	LW1S-3C2V	LW1S-3C2M
			3PDT	LW1S-3C3	LW1S-3C3V	—
		Silver	DPDT	LW1S-3C6	—	LW1S-3C6M
			3PDT	LW1S-3C7	—	—

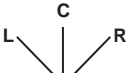

-  1. Knob color: Black; Directional Indication Color: White
 2. For contact operation, see next page.
 3. For sub-assembly part numbers, see page A3-118.

Part Numbers: LW1K Keylock Selector Switches

Style	Position	Contact Material	Contact	Part Number		
				Solder/Tab	PC Board	Screw
Round 	90° 2-position maintained 	Gold	SPDT	LW1K-2C1A	LW1K-2C1VA	—
			DPDT	LW1K-2C2A	LW1K-2C2VA	LW1K-2C2MA
			3PDT	LW1K-2C3A	LW1K-2C3VA	—
		Silver	SPDT	LW1K-2C5A	—	—
			DPDT	LW1K-2C6A	—	LW1K-2C6MA
			3PDT	LW1K-2C7A	—	—
	45° 3-position maintained 	Gold	DPDT	LW1K-3C2A	LW1K-3C2VA	LW1K-3C2MA
			3PDT	LW1K-3C3A	LW1K-3C3VA	—
		Silver	DPDT	LW1K-3C6A	—	LW1K-3C6MA
			3PDT	LW1K-3C7A	—	—

-  1. Every key selector uses an identical key.
 2. The key is removable in all positions.
 3. If a different configuration is required, contact an IDEC representative for more information.
 4. For contact operation, see next page.
 5. For sub-assembly part numbers, see page A3-118.

Part Numbers: LW1F LED and Incandescent Illuminated Selector Switches

Style	Position	Contact Material	Contact	Part Numbers		
				Solder/Tab	PC Board	Screw
Round 	90° 2-position maintained 	Gold	SPDT	LW1F-2C10-②	LW1F-2C10V-②	—
			DPDT	LW1F-2C20-②	LW1F-2C20V-②	LW1F-2C20M-②
			3PDT	LW1F-2C30-②	LW1F-2C30V-②	—
		Silver	SPDT	LW1F-2C50-②	—	—
			DPDT	LW1F-2C60-②	—	LW1F-2C60M-②
			3PDT	LW1F-2C70-②	—	—
	45° 3-position maintained 	Gold	DPDT	LW1F-3C20-②	LW1F-3C20V-②	LW1F-3C20M-②
			3PDT	LW1F-3C30-②	LW1F-3C30V-②	—
		Silver	DPDT	LW1F-3C60-②	—	LW1F-3C60M-②
			3PDT	LW1F-3C70-②	—	—

-  1. In place of ②, specify color code. See previous page for color codes.
 2. Lamps must be ordered separately for all illuminated pushbuttons. See previous page.
 3. For contact operation, see next page.
 4. For sub-assembly part numbers, see page A3-118.

Contact Operations

Contact Operation: Selector and Keylock Switches

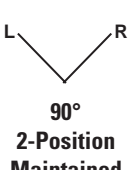
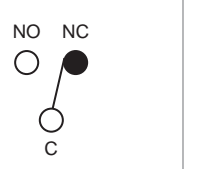
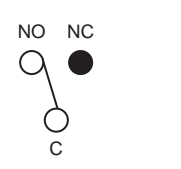
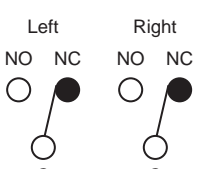
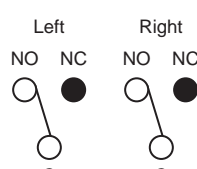
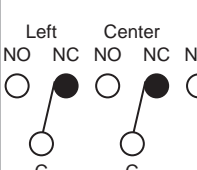
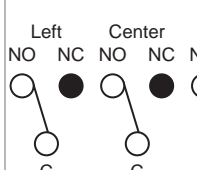
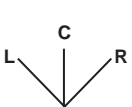
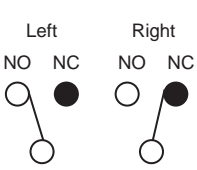
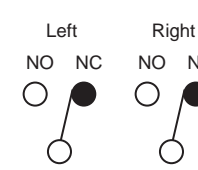
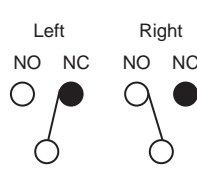
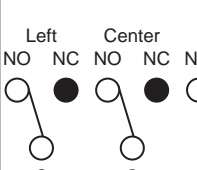
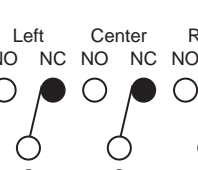
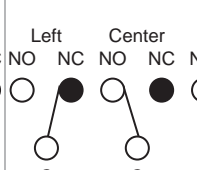
Position	Contact	Operator Position and Contact Position (Top View)		
		Left	Center	Right
 <p>90° 2-Position Maintained</p>	SPDT		-	
	DPDT		-	
	3PDT		-	
 <p>45° 3-Position Maintained</p>	DPDT			
	3PDT			

Terminal Arrangements (Bottom View): LW□L and LW□B Pushbuttons

3 pole illuminated

2 pole illuminated

3 pole non-illuminated

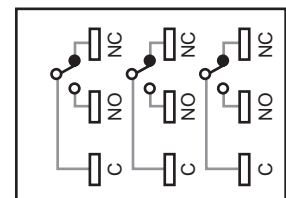
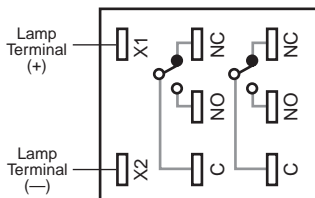
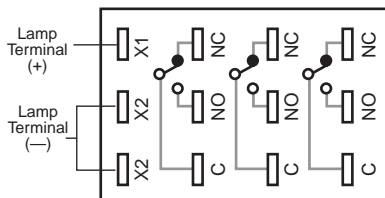

SPDT has C, NO and NC only on the center. DPDT has C, NO, and NC only on the right and left.



SPDT has C, NO and NC only on the right. DPDT has C, NO, and NC only on the right and center.

Selectors and Key Switches (Sub-Assembled)

A3

Switches & Pilot Devices



*Lens for illuminated units only

Part Numbers: Operators

Unit	Position	Part Number
Non-Illuminated Selector Switch	2-position	LW1S-2Y
	3-position	LW1S-3Y
Key Switch	2-position	LW1K-2A
	3-position	LW1K-3A
Illuminated Selector Switch	2-position	LW1F-20*
	3-position	LW1F-30*

* Lens must be purchased separately for illuminated units.

Part Numbers: Knob (Lens)

Style	Part Number
Illuminated Selector Switches	LW1A-F-②



In place of ②, specify LED/Lens Color Code from table below.

Part Numbers: Contact Blocks

Appearance	Style	Contact Material	Contact	Part Number		
				Solder/Tab	PC Board	Screw
	Illuminated Selector Switches	Gold	SPDT	LW-C10	LW-C10V	—
			DPDT	LW-C20	LW-C20V	LW-C20M
			3PDT	LW-C30	LW-C30V	—
		Silver	SPDT	LW-C50	—	—
			DPDT	LW-C60	—	LW-C60M
			3PDT	LW-C70	—	—
	Non-Illuminated Selector Switches	Gold	SPDT	LW-C1	LW-C1V	—
			DPDT	LW-C2	LW-C2V	LW-C2M
			3PDT	LW-C3	LW-C3V	—
		Silver	SPDT	LW-C5	—	—
			DPDT	LW-C6	—	LW-C6M
			3PDT	LW-C7	—	—

Part Numbers: Lamps (not included in assemblies)

Type	Voltage	Part Number
LED	6V AC/DC±10%	LSTD-6②
	12V AC/DC±10%	LSTD-1②
	24V AC/DC±10%	LSTD-2②
	120V AC±10%	LSTD-H2②
	240V AC ±10%	LSTD-M4②
Incandescent	6.3V AC/DC	IS-6
	12V AC/DC	IS-12
	24V AC/DC	IS-24













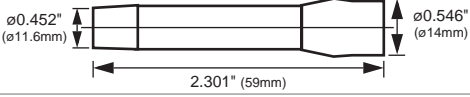

② LED/Lens Color Code

Color	Code
Amber	A
Green	G
Red	R
Blue	S
White	W
Yellow	Y

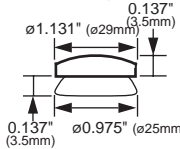

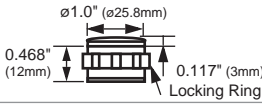
- In place of ②, specify the LED Color Code.
- The LED contains a current-limiting resistor and reverse polarity protection diode.

Accessories — LW Series

Style	Description/Usage	Part Number
Ring Wrench (optional) 	1. Metallic tool used for tightening the plastic locking ring when installing the LW series on a panel. 2. Tightening torque should not exceed 1.2N-m (12 kgf-cm) when tightening a locking ring.	LW9Z-T1
Lamp Holder Tool (optional) 	Rubber tool used for replacing incandescent or LED lamps installed in illuminated switches and pilot lights and pilot lights 	OR-55
Terminal Cover (for solder tab terminal) 	Nylon cover for pushbuttons and selectors with solder terminals snaps onto contact block. (Insert the lead wires through terminal cover holes before wiring.)	LW-VL2
Terminal Cover (for screw terminal) 	Nylon cover for pushbuttons and selectors for screw terminals snaps onto contact block. (Insert the lead wires through terminal cover holes before wiring.)	LW-VL2M
Terminal Cover (for unibody pilot light with solder tab terminal) 	Nylon cover for unibody pilot lights with solder terminals.	LW-PVL
Terminal Cover (for unibody pilot light with screw terminal) 	Nylon cover for unibody pilot lights with screw terminals.	LW-PVLM
Rubber Mounting Hole Plug 	Black rubber plug fills unused 22mm panel cutouts. 	OB-31
Metallic Mounting Hole Plug 	1. Used for plugging unnecessary mounting holes in the panel. Tighten the attached locking ring to a torque of 1.2N-m (12kgf-cm) maximum 2. Degree of Protection: IP66 	LW9Z-BM
Replacement Marking Plates 	White plastic engraving plate for use on all illuminated units (included in each lens). May be used to capture printed mylar insert (not supplied by IDEC) under lens face.	LW9Z-P1-W (round) LW9Z-P2-W (square) ALW3B (mushroom)
Anti-Rotation Ring 	Prevents rotation of switches in panel. (included with all selector and key switches only)	LW9Z-L
Replacement Keys 	One pair of keys. (#231)	KG9Z-SK
Replacement Locking Ring 	Use to secure operator to panel. (included with all assembled switches and operators)	LW9Z-LN

A3

Switches & Pilot Devices



For replacement lamps, see previous page.

Dimensions: Pushbuttons

LW□L & LW□B: Illuminated & Non-Illuminated Pushbuttons

A3
Switches & Pilot Devices

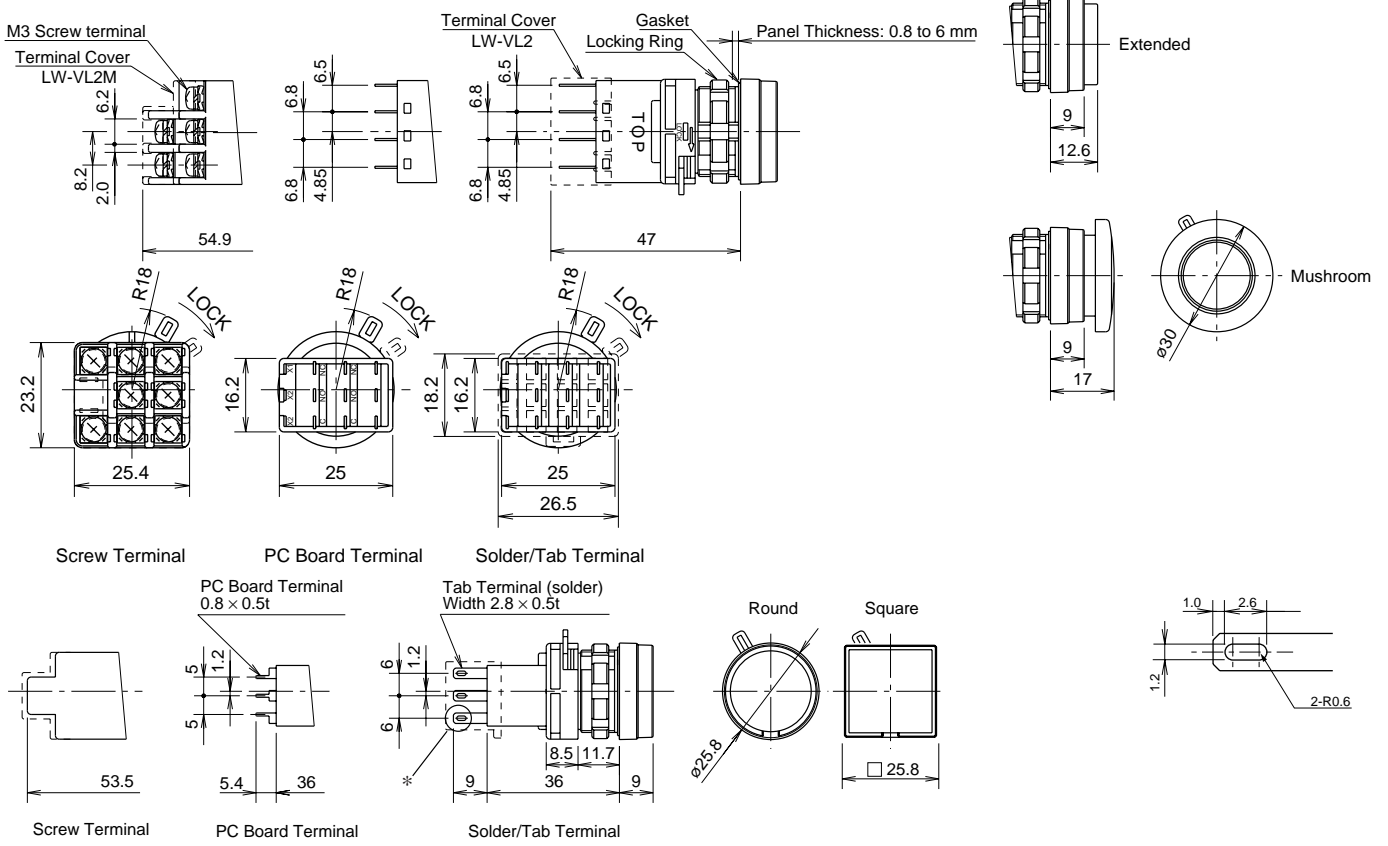
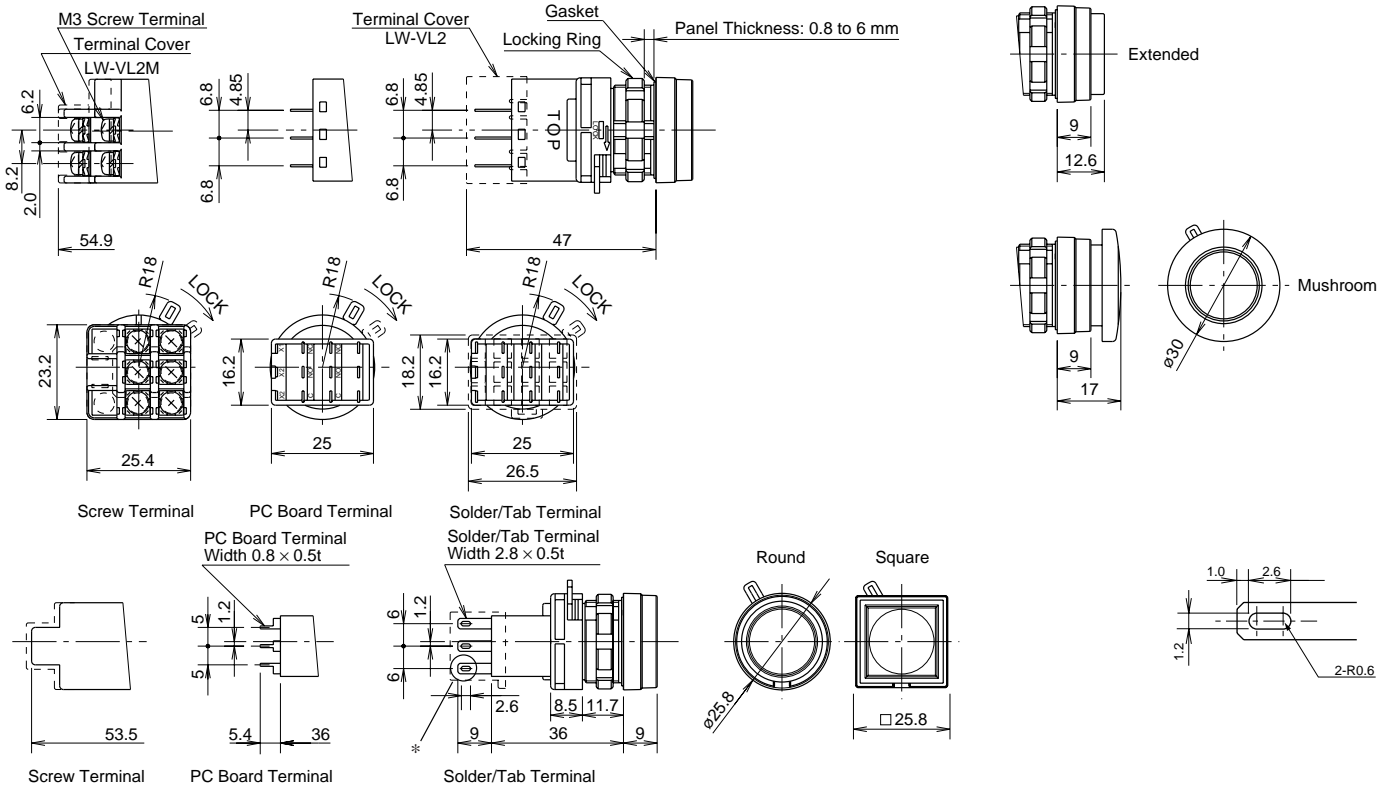

Dimensions: Pilot Lights

LW1P/LW2P Pilot Lights

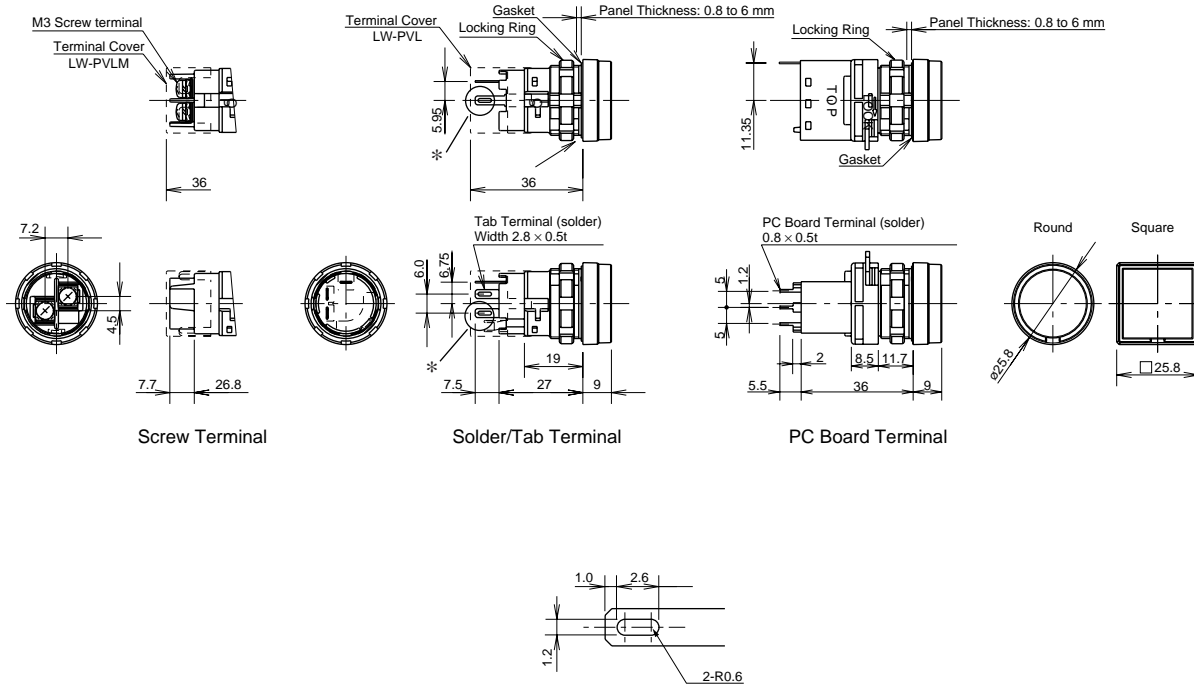

Dimensions: Selector and Keylock Switches

LW1S and LW1K Selector and Keylock Switches

A3

Switches & Pilot Devices

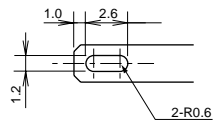
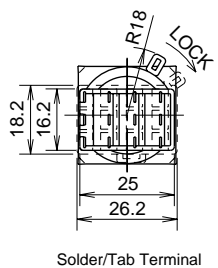
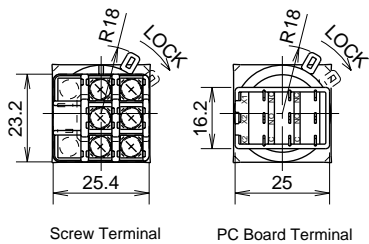
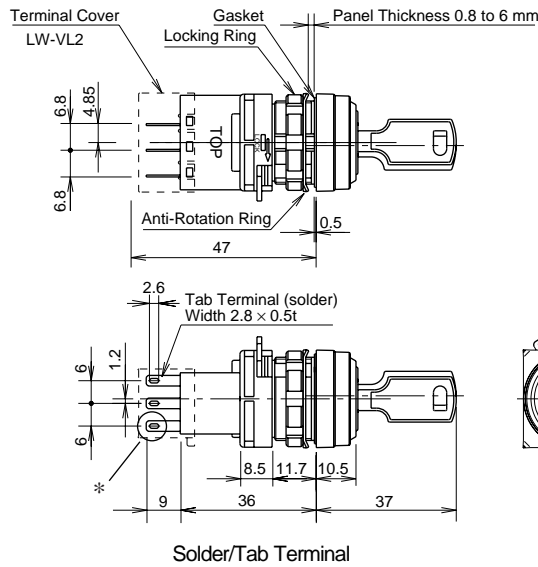
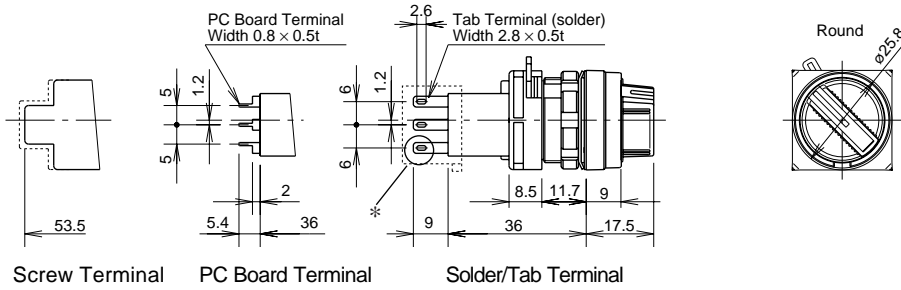
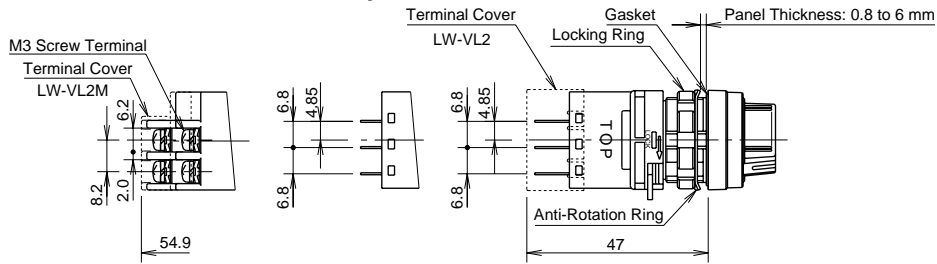

Dimensions: Selector and Keylock Switches, continued and Layouts

LW1F LED and Incandescent Illuminated Selector Switches

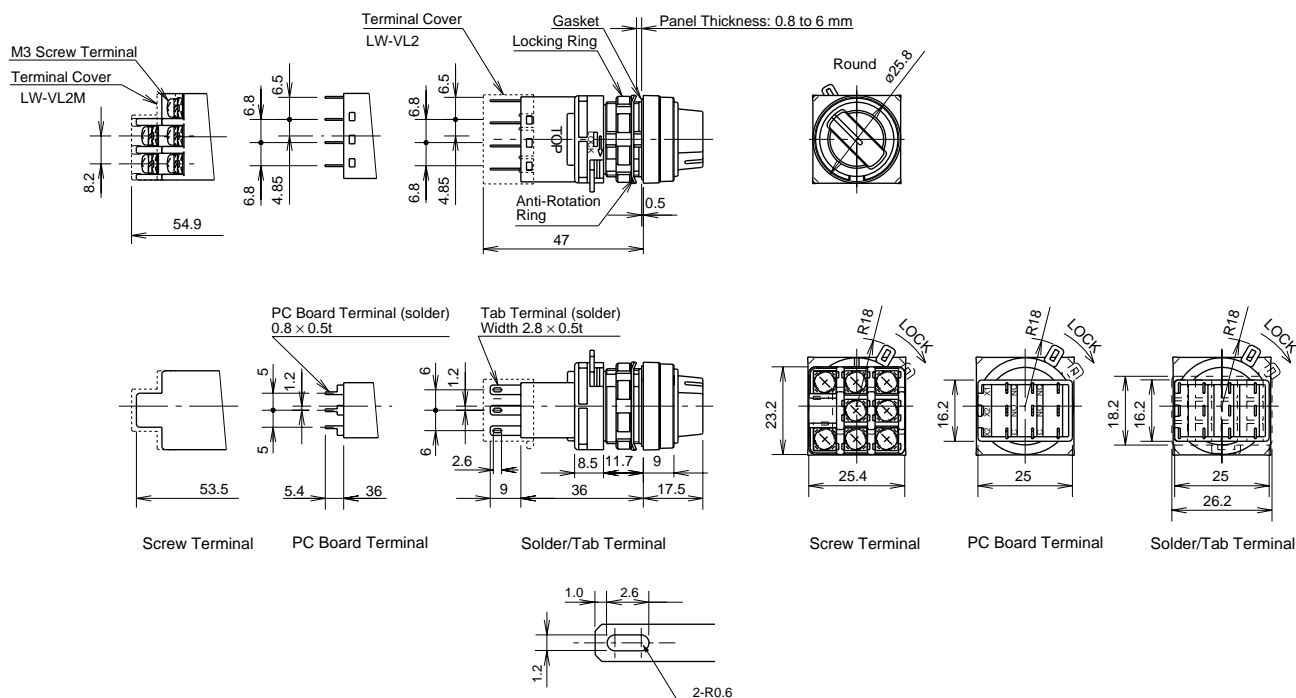

Layouts

LW□L PC Board Drilling Layout
PC Board Terminal
Bottom View

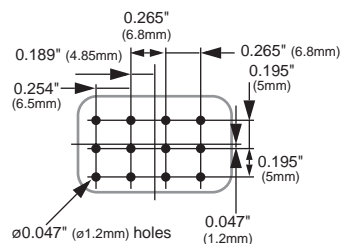

LW□B PC Board Drilling Layout
PC Board Terminal
Bottom View

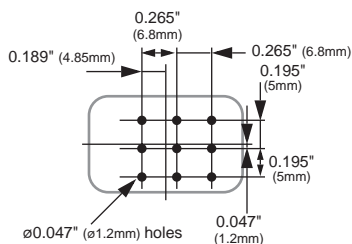

Pilot Lights
PC Board Drilling Layout
PC Board Terminal
Bottom View

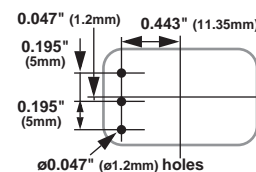

Mounting Hole Layout

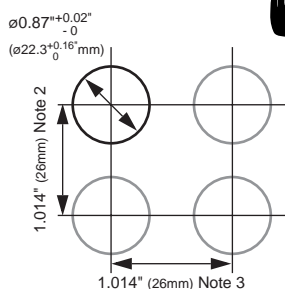

- When determining mounting centerlines, allow for easy operation.
- Mushroom (Ø 1.17" (Ø 30mm)) = 1.248" (32mm)
 Tab terminal = 1.014" (26mm) (with/without terminal cover)
 PC board terminal = 1.014" (26mm)
 Screw terminal = 1.56" (40mm)
- Mushroom (Ø 1.17" (Ø 30mm)) = 1.248" (32mm)
 Tab terminal = 1.053" (27mm) (with terminal cover)
 Tab terminal = 1.014" (26mm) (without terminal cover)
 PC board terminal = 1.014" (26mm)
 Screw terminal = 1.014" (26mm)

Replacement of Lens & Marking Plate

A3

Removing

1. Remove the operator (lens, marking plate, and lens holder) by inserting a screwdriver into the recess of the lens through the bezel.



2. Remove the marking plate by pushing the lens from the rear to disengage the latches between the lens and the lens holder, using the screwdriver as shown below.



The translucent filter in the lens holder can not be removed because this filter is sealed to make the unit waterproof and oiltight.

Installing

For round lens types, place the marking plate on the lens holder with the anti-rotation projection engaged and press the lens onto the lens holder to engage the latches. For square lens types, insert the marking plate into the lens, and press the lens onto the lens holder to engage the latches. Pay attention to the orientation of the marking plate.

Pay attention to the orientation of the marking plate.

For Round Lens

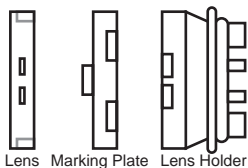

For Square Lens

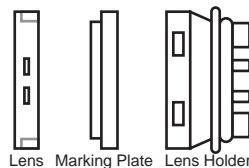

Replacement of Lamps

Lamps can be replaced using the lamp holder tool (OR-55) from the front of the panel. Also by removing the contact block from the operator unit, the lamp can be replaced.

Replacement of Lamps from the Front of the Panel.

(How to Remove)

1. Push and turn the lamp counterclockwise using the side A of the lamp holder tool, and the lamp and the lamp holder can be removed.



(How to Install)

1. Insert the lamp into the lamp holder tool and hold the lamp as in the following illustration.

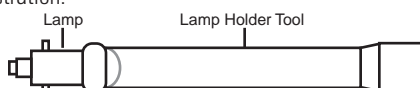

2. Place the insertion guide of the lamp and the groove in the operator unit in

the same direction. Then push the lamp lightly and turn it clockwise.

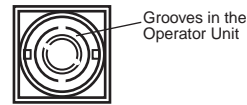

Replacement of Lamps by Removing the Contact Block

The lamp can be replaced by removing the contact block without using the lamp holder tool.

Marking Plates & Films

For LW series illuminated pushbuttons and pilot lights, legends and symbols can be engraved on marking plates, or printed mylar can be inserted under the lens for labelling purposes.

Marking Plate and Marking Film Size

Lens Style	Round Lens	Square Lens
Built-in Marking Plate		
Engraving must be made on the engraving area within 0.02" (0.5mm) deep. The marking plate is made of white acrylic resin.		
Applicable Marking Film		
Mylar for printing labels are not included and must be provided and printed by user. Two 0.004" (0.1mm)-thick films or one 0.008" (0.2mm)-thick film can be installed in the lens. Recommended marking film: Mylar		

Insertion Order of Marking Plate & Film

For Round Lens

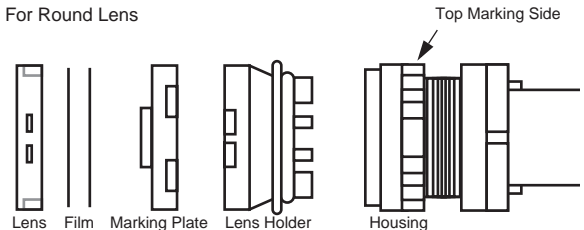

Insertion Order of Marking Plate & Film.

For Square Lens

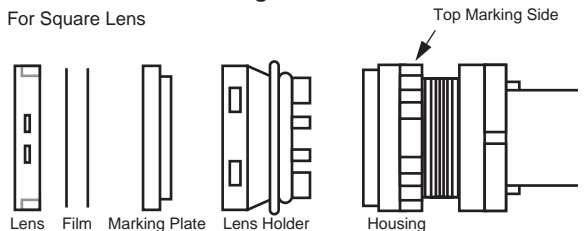

1. Mylar is not included.

2. Pay attention to the orientation of marking plate.

Instructions con't

Panel Mounting

Remove the contact block from the operator. Insert the operator into the panel cut-out from the front, then install the contact block to the operator.

Removing the Contact Block

Turn the locking lever on the contact block in the direction opposite to the arrow on the housing. Then the contact block can be removed.

Installing the Contact Block

Insert the contact block, with the TOP markings on the contact block and the operator placed in the same direction. Then lock the units, turning the locking lever in the direction of the arrow.



Notes on Mounting

Use the optional Ring Wrench (LW9Z-T1) to mount the operator onto a panel. Tightening torque should not exceed 1.2N-m (12 kgf-cm). Do not use pliers. Excessive tightening will damage the locking ring.

Wiring

1. Solder the terminals within 20W/5 seconds or 260°C/3 seconds without exerting external force to the terminals. While soldering, do not touch the soldering iron to the housing. While wiring, prevent tension from being applied to the terminals. Do not bend or raise the terminals, nor exert excessive force to terminals.
2. Use a non-corrosive resin liquid flux.

Collective Mounting

As the locking lever can be turned easily from the rear of the units using a screwdriver, the contact blocks can be removed even when mounted collectively.

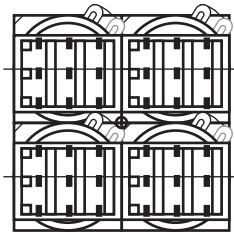

Notes for Terminal Cover

(Solder/Tab Terminal)

Insert the terminal cover into the contact block with the TOP markings on the contact block and the terminal cover in the same direction.



When wiring, insert the lead wires into the terminal cover holes before wiring.



Notes for Wiring

When installing a terminal cover onto the solder/tab terminal contact block, solder the inside of lamp terminal (toward the switch terminals) and wire.

(Screw Terminal Type)

Install a terminal cover to the control unit before wiring.



1. After wiring, terminal covers cannot be installed.
2. When terminal covers are used, round crimping terminals cannot be used.

Connection

Positive-lock connector and easy-lock connector are applicable to tab terminals.

Single Board Mounting

Mounting the switches and pilot lights on one PC board offers the following features.

1. Reduced installation labor, easy wiring, space saving, and standardization.
2. Since the contact blocks on the PC board can be removed easily using a locking lever, the LW series switches and pilot lights are easy to maintain.
3. Because the LW series switches and pilot lights require no studs for fastening the control unit to a PC board, special preparation of operation panel is not needed.

For details on one board mounting, contact IDEC.



Light Touch And High Reliability

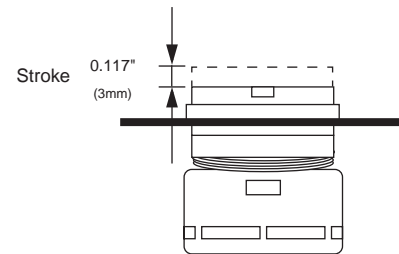

Operating-force Snap Switching Mechanism

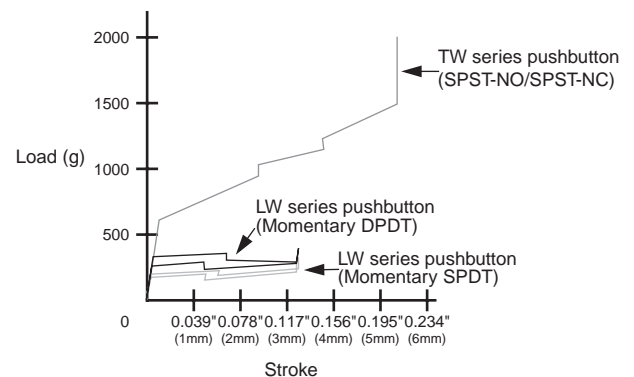

A3

Switches & Pilot Devices



TW NEMA Style Switches with snap-on contacts

Key features include:

- Corrosion resistant octagonal chrome plated locking bezel
- Snap-on 10A contact blocks
- Transformer or full voltage
- Incandescent or LED illumination
- Slow make, double break, self cleaning contacts
- Modular construction for maximum flexibility
- NEMA 4X and IP65 watertight/oiltight panel
- Available assembled or as sub-components
- Large M3.5 screw terminals with captive sems plate

IDEC has your 22mm switching needs covered.

Button styles include flush, extended, mushroom, or square and all bodies are crafted from fracture-resistant nylon.

All illuminated units feature two lense styles, one that maximizes light dispersion, the other accommodates direct lense engraving.

Self cleaning contact mechanisms allow for a wide current rating, 5mA to 10A, which reduces the need for various contact materials.

When looking for a 22mm switch that is durable, easy to use, and versatile, then IDEC's TW series is your solution.



UL Listed
File No. E70646



File No. 9561116E01







CSA Certified
File No. LR48366



File No. DK95-01696



Certificate No.
2030010305027380

Specifications	Conforming to Standards	EN60947-1, EN60947-5-1, VDE0660-200, UL508, CSA C22-2 No.14
	Approvals	<div style="display: flex; justify-content: space-around; align-items: flex-start;"> <div style="text-align: center;">  File No. E68961 </div> <div style="text-align: center;">  File No. LR21451 </div> <div style="text-align: center;">  Certificate No. 2030010305027380 </div> </div> <div style="display: flex; justify-content: space-around; align-items: flex-start; margin-top: 10px;"> <div style="text-align: center;">  TÜV Rheinland Registration No: J9551802 (E-Stops) Registration No: J9551803 (All other switches) Registration No: J9551804 (Pilot Lights) </div> <div style="text-align: center;">  </div> </div> <p>CSA: pushbuttons and selector switches: A600 pilot lights and illuminated pushbuttons, direct supply pilot lights and illuminated pushbuttons with integral transformer (100/110, 115, 120, 200/220, 230, 240, 380, 400/440, 480V) UL: pushbuttons and selector switches: A600 pilot lights and illuminated pushbuttons, direct supply pilot lights and illuminated pushbuttons with integral transformer (100/110, 115, 120, 200/220, 230, 240, 380, 400/440, 480V) TÜV: pushbuttons and selector switches: A600=P600 (NO, NC)/Q600 (NO-EM, NC-LB) pilot lights and illuminated pushbuttons, direct supply pilot lights and illuminated pushbuttons with integral transformer (100/110, 115, 120, 200/220, 230, 240, 380, 400/440, 480V)</p>
	Operating Temperature	Operation: -25 to +50°C (without freezing) Storage: -40 to +80°C (without freezing)
	Vibration Resistance	5 to 55Hz, 100m/sec ² (10g) conforming to IEC6068-2-6
	Shock Resistance	1000m/sec ² (100g) conforming to IEC6068-2-7
	Electric Shock Protection	Class 0 conforming to IEC60536
	Degree of Protection (conforming to IEC60529) (conforming to NEMA ICS6-110)	IP65 from front of the panel; (IP54 for key switches) IP20 (Type HW-F contact block) NEMA 1, 2, 3, 3R, 3S, 4, 4X, 5, 12, 13 (NEMA 1, 2, 3R, 5, 12, 13 for key switches)
	Mechanical Life	Momentary pushbuttons: 5,000,000 (900 operations per hour) All other switches: 500,000
	Pollution Degree (conforming to IEC60947-1)	3 for switches not using a transformer 2 for switches using a transformer
	Rated Operational Characteristics	AC-15: A600 or Ue = 250V, Ie = 3A (NO, NC, NO-EM, NC-LB) DC-13: P600 or Ue = 125V, Ie = 1.1A (NO, NC) DC-13: Q600 or Ue = 125V, Ie = 0.9A (NO-EM, NC-LB)
	Rated Insulation Voltage	600V
	Rated Switching Over-Voltage	Less than 4kV, conforming to IEC60947-1
	Rated Impulse Withstanding Voltage	4kV for contact circuit 2.5kV for lamp circuit
	Rated Thermal Current	10 Amp
	Minimum Switching Capacity	5 mA at 3V AC/DC
	Contact Operation	Slow break NC or slow make NO, self-cleaning
	Recommended Terminal Torque	0.8 N m (7.1 in lb.)
	External Short-Circuit Protection	10A 250V fuse conforming to IEC60269-1
	Applicable Wire Size	Minimum 1 x 22 AWG, max. 2 x 14 AWG or 1 x 12 AWG
	Contact Resistance	Initial contact resistance of 50mΩ or less
	Contact Gap	4mm (NO and NC) 2mm (NO-EM and NC-LB)
	Electrical Reliability	MTBF < 1 fault for 10 million operation cycles (3V DC, 5mA)
	Lamp Ratings	Incandescent: 1 W LEDs: 6V: 17mA max, 12/24V: 11mA max, 120/240V: 10mA max
	Horsepower Rating	1/4 HP @ 120V (single-phase, non-reversing motor); 1 HP @ 240V (3 phase, non-reversing motor)
	Maximum Inrush Current	40 A (40 ms)
Contact Material	Silver	

Contact Ratings	Pushbuttons Illuminated Pushbuttons Selector Switches Illuminated Selector Switches Pushbutton Selectors	Contact Block	Type HW-C/HW-F
		Rated Insulation Voltage	600V
		Rated Continuous Current	10A
		Contact Ratings by Utilization Category IEC 60947-5-1	AC-15 (A600) DC-13 (P600)

		Contact Ratings by Utilization Category							
Operational Voltage		24V	48V	50V	110V	220V	440V		
Characteristics	Operational Current	AC 50/60 Hz	AC-12 Control of resistive loads & solid state loads	10A	—	10A	10A	6A	2A
		AC-15 Control of electromagnetic loads (> 72VA)	10A	—	7A	5A	3A	1A	
	DC	DC-12 Control of resistive loads & solid state loads	8A	5A	—	2.2A	1.1A	—	
		DC-13 Control of electromagnets	5A	2A	—	1.1A	0.6A	—	

Non-Illuminated Pushbuttons (Assembled)

A3

Switches & Pilot Devices



Assembled Pushbuttons

A B () W 1 10 () - B

Function

- B: Momentary
- O: Maintained
- K: Key On/Off Lock

Bezel Shape

- Blank: Octagonal
- F: Full Shroud
- G: Mushroom Shroud
- Q: Square

Button Color

- B: Black G: Green W: White
- R: Red S: Blue Y: Yellow

Terminal Style

- Blank: Standard
- N: Fingersafe (IP20)

Contact Arrangement

- 10: 1NO 01: 1NC
- 20: 2NO 02: 2NC
- 11: 1NO-1NC 22: 2NO-2NC

Button Shape

- 1: Flush
- 2: Extended
- 3: Mushroom Head Ø 29mm
- 4: Mushroom Head Ø 40mm

Series Designation

- W: TW Series



To be used for interpreting part numbers only, not for part number development.

Non-Illuminated Pushbuttons (Assembled) con't

Part Numbers: Non-illuminated Pushbuttons

Style	Contacts	Momentary Action	Maintained Action
Flush	1NO 1NC 1NO-1NC 2NO 2NC	ABW110-① ABW101-① ABW111-① ABW120-① ABW102-①	AOW110-① AOW101-① AOW111-① AOW120-① AOW102-①
Extended	1NO 1NC 1NO-1NC 2NO 2NC	ABW210-① ABW201-① ABW211-① ABW220-① ABW202-①	AOW210-① AOW201-① AOW211-① AOW220-① AOW202-①
Recessed	1NO 1NC 1NO-1NC 2NO 2NC	ABFW110-① ABFW101-① ABFW111-① ABFW120-① ABFW102-①	AOFW110-① AOFW101-① AOFW111-① AOFW120-① AOFW102-①
Extended with Full Shroud	1NO 1NC 1NO-1NC 2NO 2NC	ABFW210-① ABFW201-① ABFW211-① ABFW220-① ABFW202-①	AOFW210-① AOFW201-① AOFW211-① AOFW220-① AOFW202-①
Ø 29mm Mushroom Head	1NO 1NC 1NO-1NC 2NO 2NC	ABW310-① ABW301-① ABW311-① ABW320-① ABW302-①	AOW310-① AOW301-① AOW311-① AOW320-① AOW302-①
Ø 40mm Mushroom Head	1NO 1NC 1NO-1NC 2NO 2NC	ABW410-① ABW401-① ABW411-① ABW420-① ABW402-①	AOW410-① AOW401-① AOW411-① AOW420-① AOW402-①
Ø 40mm Mushroom Head with Full Shroud	1NO 1NC 1NO-1NC 2NO 2NC	ABGW410-① ABGW401-① ABGW411-① ABGW420-① ABGW402-①	AOGW410-① AOGW401-① AOGW411-① AOGW420-① AOGW402-①
Square Flush	1NO 1NC 1NO-1NC 2NO 2NC	ABQW110-① ABQW101-① ABQW111-① ABQW120-① ABQW102-①	AQQW110-① AQQW101-① AQQW111-① AQQW120-① AQQW102-①
Square Extended	1NO 1NC 1NO-1NC 2NO 2NC	ABQW210-① ABQW201-① ABQW211-① ABQW220-① ABQW202-①	AQQW210-① AQQW201-① AQQW211-① AQQW220-① AQQW202-①
Keylock Push On/Off	1NO 1NC 1NO-1NC 2NO 2NC	AKW210 AKW201 AKW211 AKW220 AKW202	—

① Button Color Code

Color	Code
Black	B
Green	G
Red	R
Blue	S
White	W
Yellow	Y

A3

Switches & Pilot Devices



1. In place of ①, specify the Button Color Code from table.
2. For sub-assembled part numbers, see page A3-130.
3. For accessories, see page A3-156.
4. For dimensions, see page A3-158.
5. Keyed switches are supplied with two keys. All units are keyed alike. For custom keys, contact IDEC.

Non-Illuminated Pushbuttons (Sub-Assembled)

Contact Blocks + Operator + Button = Complete Part



A3

Switches & Pilot Devices

Part Numbers: Operators



Style	Part Number	
	Momentary	Maintained
Round Flush/Extended 	ABW-100	AOW-100
Round with Full Shroud 	ABFW-200	AOFW-200
Ø 40mm, Ø 29mm Mushroom Head 	ABW-300	AOW-300
Ø 40mm Mushroom Head with Full Shroud 	ABGW-400	AOGW-400
Square Flush/Extended 	ABQW-100	AQQW-100
Keylock Push On/Off 	AKW-200	

Part Numbers: Buttons

Style	Part Number
Round Flush 	ABW1B-①
Round Extended 	ABW2B-①
Ø 29mm Mushroom 	ABW3B-①
Ø 40mm Mushroom 	ABW4B-①
Square Flush 	ABQW1B-①
Square Extended 	ABQW2B-①

 In place of ①, specify the Button Color Code from table.

Part Numbers: Contact Blocks

Description	Part Number	
	1NO	1NC
Standard Exposed Screw 	HW-C10 HW-C10R (early make)	HW-C01 HW-C01R (late break)
Fingersafe (IP20), CE marked 	HW-F10 HW-F10R (early make)	HW-F01 HW-F01R (late break)
Dummy Block 	TW-DB	

-  1. Dummy blocks (no contacts) are used with an odd number of contact blocks.
- 2. Use of early and late break contacts creates a make before break function

① Button Color Code

Color	Code
Black	B
Green	G
Red	R
Blue	S
White	W
Yellow	Y

E-Stops (Assembled)



A3

Switches & Pilot Devices

Assembled E-Stops

A V (L) W 4 (B) (99) 11 (D) (N) - R - (24V)

<p>Function</p> <p>V: Pushlock Turn Reset Y: Push-Pull X: Pushlock Key Reset</p> <p>Illumination</p> <p>Blank: None L: Illuminated</p> <p>Series Designation</p> <p>W: TW Series</p> <p>Button/Lens Size</p> <p>3: 29mm Mushroom 4: 40mm Mushroom</p> <p>Lens Type (illuminated units only)</p> <p>Blank: Standard (ribbed) B: Engravable (smooth with insert)</p> <p>Illuminated Circuit (illuminated unit only)</p> <p>99: Full Voltage (lamp determines voltage) 126: 120V AC Step Down Transformer 246: 240V AC Step Down Transformer 486: 480V AC Step Down Transformer</p>	<p>Lamp Voltage (full voltage illuminated units only)</p> <p>6V: 6V AC/DC 12V: 12V AC/DC 24V: 24V AC/DC 120V: 120V AC (LED only) 240V: 240V AC (LED only)</p> <p>Button/Lens Color</p> <p>A: Amber R: Red W: White G: Green S: Blue Y: Yellow B: Black</p> <p>Contact Terminal Style</p> <p>Blank: Standard N: Fingersafe (IP20)</p> <p>Lamp Type (illuminated units only)</p> <p>Blank: Incandescent D: LED</p> <p>Contact Arrangement</p> <p>10: 1NO 01: 1NC 20: 2NO 02: 2NC 11: 1NO/1NC 22: 2NO/2NC</p>
--	--



Use only for interpreting part numbers. Do not use for developing part numbers.

E-Stops (Assembled) con't

Part Numbers: Non-Illuminated E-Stops

Style	Contacts	Part Number
Ø 40mm Pushlock Turn Reset* 	1NO 1NC 1NO-1NC 2NO 2NC	AVW410-R* AVW401-R* AVW411-R* AVW420-R* AVW402-R*
Ø 29mm Pushlock Turn Reset* 	1NO 1NC 1NO-1NC 2NO 2NC	AVW310-R* AVW301-R* AVW311-R* AVW320-R* AVW302-R*
Ø 40mm Push-Pull 	1NO 1NC 1NO-1NC 2NO 2NC	AYW410-① AYW401-① AYW411-① AYW420-① AYW402-①
Ø 40mm Pushlock Key Reset * 	1NO 1NC 1NO-1NC 2NO 2NC	AXW410- R* AXW401- R* AXW411- R* AXW420- R* AXW402- R*

- 1. *Available in Red only.
- 2. In place of ①, specify the Button Color Code from table.
- 3. For sub-assembled part numbers, see page A3-130.
- 4. For accessories, see page A3-156.
- 5. For dimensions, see page A3-158.

Part Numbers: Illuminated E-Stops

Style	Type	Contacts	Part Number
Ø 40mm Pushlock Turn Reset Type 	Transformer	1NO-1NC 2NO 2NC	AVLW4 ④ 11⑤-R* AVLW4 ④ 20⑤-R* AVLW4 ④ 02⑤-R*
	Full Voltage	1NO-1NC 2NO 2NC	AVLW49911⑤-R*-③ AVLW49920⑤-R*-③ AVLW49902⑤-R*-③
Ø 29mm Pushlock Turn Reset 	Transformer	1NO-1NC 2NO 2NC	AVLW3④11⑤-R* AVLW3④20⑤-R* AVLW3④02⑤-R*
	Full Voltage	1NO-1NC 2NO 2NC	AVLW39911⑤-R*-③ AVLW39920⑤-R*-③ AVLW39902⑤-R*-③
Ø 40mm Push-Pull 	Transformer	1NO-1NC 2NO 2NC	AYLW4 ④ 11⑤-② AYLW4 ④ 20⑤-② AYLW4 ④ 02⑤-②
	Full Voltage	1NO-1NC 2NO 2NC	AYLW49911⑤-②-③ AYLW49920⑤-②-③ AYLW49902⑤-②-③

- 1. *Available in red only.
- 2. In place of ②, specify the Lens Color Code (see table above).
- 3. In place of ③, specify the Full Voltage Code (lamp voltage) (see table above).
- 4. In place of ④, specify the Transformer Voltage Code (see table above).
- 5. In place of ⑤, specify the Lamp Type Code from table above.
- 6. For sub-assembly part numbers, see page A3-134.
- 7. For accessories, see page A3-156.
- 8. For dimensions, see page A3-158.

① Button Color Code

Color	Code
Black	B
Green	G
Red	R
Blue	S
White	W
Yellow	Y

② LED/Lens Color Code

Color	Code
Amber	A
Green	G
Red	R
Blue	S
White	W

③ Full Voltage Code

Voltage	Code
6V AC/DC	6V
12V AC/DC	12V
24V AC/DC	24V
120V AC	120V (LED only)
240V AC	240V (LED only)

④ Transformer Voltage Codes

Voltage	Code
120VAC	126
240VAC	246
480VAC	486

⑤ Lamp Type Code

Lamp	Code
Incandescent	Blank
LED	D

Transformers step down to 6V.

E-Stops (Sub-Assembled)

Transformer/ Adaptor* + Contacts + Lamp Holder + Operator + Lamp + Button or Lens = Complete Part





* Not applicable for full voltage units

Part Numbers: Operators

Style	Part Number	
	Non-illuminated	Illuminated
Ø 29/Ø 40mm Pushlock Turn Reset 	AVW-300	AVLW3-0600
Ø 40mm Push-Pull 	AYW-400	AYLW4-0600
Ø 40mm Pushlock Key Reset 	AXW-300	—

Part Numbers: Lamps

Type	Voltage	Part Number
LED 	6V AC/DC	LSTD-6 ^②
	12V AC/DC	LSTD-1 ^②
	24V AC/DC	LSTD-2 ^②
	120V AC	LSTD-H2 ^②
	240V AC	LSTD-M4 ^②
Incandescent 	6V AC/DC	IS-6
	12V AC/DC	IS-12
	24V AC/DC	IS-24



- In place of ^②, specify the LED color code.
- The LED contains a current-limiting resistor and a protection diode.

Part Numbers: Buttons

Style	Part Number
Ø 40mm Pushlock Turn Reset 	AVW4B-R*
Ø 29mm Pushlock Turn Reset 	AVW3B-R*
Ø 40mm Push-Pull 	AYW4B- ^①
Ø 40mm Pushlock Key Reset 	AXW4B-R*



- *Available in Red only
- In place of ^①, specify the button color code from table below.

① Button Color Code

Color	Code
Black	B
Green	G
Red	R
Blue	S
White	W
Yellow	Y

② LED/Lens Color Code

Color	Code
Amber	A
Green	G
Red	R
Blue	S
White	W

A3

Switches & Pilot Devices

Illuminated E-Stops (Sub-Assembled) con't





Part Numbers: Lenses

Style	Part Number	
	Standard	Engravable
 Ø 29mm Head Pushlock Turn Reset	AVLW3LU-R*	AVLW3BLU-R*
 Ø 40mm Head Pushlock Turn Reset	AVLW4LU-R*	AVLW4BLU-R*
 Ø 40mm Head Push Pull	AYLW4LU-②	AYLW4BLU-②



- In place of ②, specify the lens color code from table on the bottom right.
- *Available only in red
- Standard lenses have ribbed pattern, Engravable lenses are smooth and include an engravable insert.



Part Numbers: Transformers/Full Voltage Modules

Style	Description		Part Number
 Full Size Transformer	Standard	120V AC	TW-T126B
		240V AC	TW-T246B
		480V AC	TW-T486B
	Fingersafe	120V AC	TW-F126B
		240V AC	TW-F246B
		480V AC	TW-F486B
 Half Size Transformer	120V AC	TW-T126SB	
	240V AC	TW-T246SB	
 Full voltage model (use with even number of contacts)	Standard	TW-DA1B	
	Fingersafe	TW-DA1FB	
 Full voltage model (use with odd number of contacts)	Standard	HW-DA1B	
	Fingersafe	HW-DA1FB	





All Transformers step down to 6V (use 6V lamp).

Part Numbers: Lamp Circuit Components

Style	Application	Part Number
 Short Lamp Holder	Used with a Half-size Transformer and one contact block	TW-LH1
 Long Lamp Holder	Used with Full-size Transformer and two contact blocks Used with Half-size Transformer and three contact blocks Used with Full Voltage Adaptor and two contact blocks	TW-LH2
 Lead Holder	Used with TW-LH2 holder when using four contact blocks	HW-LH3

Part Numbers: Contact Blocks

Description	Part Number	
	1NO	1NC
 Standard Exposed Screw	HW-C10	HW-C01
	HW-C10R (early make)	HW-C01R (late break)
 Fingersafe (IP20), CE marked	HW-F10	HW-F01
	HW-F10R (early make)	HW-F01R (late break)
 Dummy Block	TW-DB	



- Dummy blocks (no contacts) are used with an odd number of contact blocks.
- Use of early and late break contacts creates a make before break function

Pilot Lights (Assembled)



A3

Switches & Pilot Devices

Assembled Pilot Lights

A P (Q) W 1 (B) 99 (D) - R - (24V)

<p>Function _____</p> <p>P: Pilot Light</p> <p>Bezel Shape _____</p> <p>Blank: Octagonal (round lenses) Q: Square</p> <p>Series Designation _____</p> <p>W: TW Series</p> <p>Lens Shape _____</p> <p>1: Flat 2: Dome</p> <p>Lens Type _____</p> <p>Blank: Standard (ribbed) B: Engravable (smooth with insert included)</p> <p>Illumination Circuit _____</p> <p>99: Full Voltage (lamp determines voltage) 126:120V AC Step Down Transformer 246:240V AC Step Down Transformer 486:480V AC Step Down Transformer</p>	<p>Lamp Voltage (Full Voltage Units Only) 6V: 6V AC/DC 12V: 12V AC/DC 24V: 24V AC/DC 120V: 120V AC (LED only) 240V: 240V AC (LED only)</p> <p>Lens Color Code A: Amber G: Green R: Red S: Blue W: White Y: Yellow</p> <p>Lamp Type Blank: Incandescent D: LED</p>
---	--





1. Use only when interpreting part numbers. Do not use for developing part numbers.
2. All transformers step down to 6V.

Pilot Lights (Assembled) con't

Part Numbers: Pilot Lights

A3

Switches & Pilot Devices

Style		Operating Voltage	Part Number
 Round Flat	Transformer	120VAC 240VAC 480VAC	APW1126 ^{④-②} APW1246 ^{④-②} APW1486 ^{④-②}
	Full Voltage	—	APW199 ^{④-②-③}
 Dome	Transformer	120VAC 240VAC 480VAC	APW2126 ^{④-②} APW2246 ^{④-②} APW2486 ^{④-②}
	Full Voltage	—	APW299 ^{④-②-③}
 Square Flat	Transformer	120VAC 240VAC 480VAC	APQW1B126 ^{④-②} APQW1B246 ^{④-②} APQW1B486 ^{④-②}
	Full Voltage	—	APQW1B99 ^{④-②-③}

-  1. In place of ②, specify the Lens Color Code from table below.
 2. In place of ③, specify the Full Voltage Code from table below.
 3. In place of ④, specify the Lamp Type Code from table below.
 4. For accessories, see page A3-156.
 5. For dimensions, see page A3-158.
 6. For sub-assembly part numbers, see next page.

② Lens Color Code

Color	Code
Amber	A
Green	G
Red	R
Blue	S
White	W
Yellow	Y

③ Full Voltage Code

Voltage	Code
6V AC/DC	6V
12V AC/DC	12V
24V AC/DC	24V
120V AC	120V (LED only)
240V AC	240V (LED only)

④ Lamp Type Code

Lamp	Code
Incandescent	Blank
LED	D

Pilot Lights (Sub-Assembled)

A3



Switches & Pilot Devices

Transformer + Operator + Lamp + Lens = Complete Part



*Transformer not required for full voltage units.

Part Numbers: Operators

Style	Part Number
Round Dome/Flat 	APW-199
Square 	UPQW-199



Same operator is used for full voltage as for transformer completed units.

Part Numbers: Lenses

Style	Part Number	
	Standard	Engravable
Dome	APW2LU-②	—
Round Flat	APW1LU-②	APW1BLU-②
Square Flat	—	APQW1BLU-②



1. In place of ②, specify the Lens Color Code from table below.
2. Standard lenses have a ribbed lens to enhance light dispersion. Marking lenses are smooth and include an engravable insert.



② Lens/LED Color Code

Color	Code
Amber	A
Green	G
Red	R
Blue	S
White	W
Yellow	Y



If clear lens is desired, use white marking lens and remove engraving insert

Part Numbers: Lamps

Type	Voltage	Part Number
LED 	6V AC/DC	LSTD-6②
	12V AC/DC	LSTD-1②
	24V AC/DC	LSTD-2②
	120V AC	LSTD-H2②
	240V AC	LSTD-M4②
Incandescent 	6V AC/DC	IS-6
	12V AC/DC	IS-12
	24V AC/DC	IS-24
	30V AC/DC	IS-30



1. In place of ②, specify the LED Color Code from table below.
2. The LED contains a current-limiting resistor and diode bridge.

Part Numbers: Transformers

Style	Description	Part Number	
	Standard	120V AC	TW-T126B
		240V AC	TW-T246B
		480V AC	TW-T486B
	Fingersafe	120V AC	TW-F126B
		240V AC	TW-F246B
		480V AC	TW-F486B



All Transformers step down to 6V (use 6V lamp).

Illuminated Pushbuttons (Assembled)

A3

Switches & Pilot Devices



Assembled Illuminated Pushbuttons

A L (F) W 2 (B) 99 11 (D) (N) - R - (24V)

Function

- L: Momentary Action
- OL: Maintained Action

Bezel Shape

- Blank: Octagonal (round lenses)
- F: Full Shroud (round lenses)
- Q: Square

Series Designation

- W: TW series

Lens Shape/Size

- 2: Standard Extended (round or square)
- 3: 29mm Mushroom
- 4: 40mm Mushroom

Lens Type

- Blank: Standard (ribbed)
- B: Engravable (smooth with insert)

Illumination Circuit

- 99: Full Voltage (lamp determines voltage)
- 126: 120V AC Step Down Transformer
- 246: 240V AC Step Down Transformer
- 486: 480V AC Step Down Transformer

Lamp Voltage

- (Full Voltage Units Only)
- 6V: 6V AC/DC
 - 12V: 12V AC/DC
 - 24V: 24V AC/DC
 - 120V: 120V AC (LED only)
 - 240V: 240V AC (LED only)

Lens Code

- A: Amber
- G: Green
- R: Red
- S: Blue
- W: White
- Y: Yellow

Contact Terminal Style

- Blank: Standard
- N: Fingersafe

Lamp Type

- Blank: Incandescent Lamp
- D: LED Lamp

Contact Arrangement





- 10: 1NO
- 20: 2NO
- 11: 1NO-1NC
- 01: 1NC
- 02: 2NC
- 22: 2NO-2NC



1. Use only when interpreting part numbers. Do not use for developing part numbers.
2. Transformers step down to 6V.

Illuminated Pushbuttons (Assembled)

Part Numbers: Illuminated Pushbuttons

Style		Contacts	Part Number	
			Momentary	Maintained
 Extended Lens	Transformer Type	1NO-1NC 2NO 2NC	ALW2 ④ 11⑤-② ALW2 ④ 20⑤-② ALW2 ④ 02⑤-②	AOLW2 ④ 11⑤-② AOLW2 ④ 20⑤-② AOLW2 ④ 02⑤-②
	Full Voltage	1NO-1NC 2NO 2NC	ALW29911⑤-②-③ ALW29920⑤-②-③ ALW29902⑤-②-③	AOLW29911⑤-②-③ AOLW29920⑤-②-③ AOLW29902⑤-②-③
 Extended Lens with Full Shroud	Transformer Type	1NO-1NC 2NO 2NC	ALFW2 ④ 11⑤-② ALFW2 ④ 20⑤-② ALFW2 ④ 02⑤-②	AOLFW2 ④ 11⑤-② AOLFW2 ④ 20⑤-② AOLFW2 ④ 02⑤-②
	Full Voltage	1NO-1NC 2NO 2NC	ALFW29911⑤-②-③ ALFW29920⑤-②-③ ALFW29902⑤-②-③	AOLFW29911⑤-②-③ AOLFW29920⑤-②-③ AOLFW29902⑤-②-③
 Ø 29mm Mushroom Lens	Transformer Type	1NO-1NC 2NO 2NC	ALW3 ④ 11⑤-② ALW3 ④ 20⑤-② ALW3 ④ 02⑤-②	AOLW3 ④ 11⑤-② AOLW3 ④ 20⑤-② AOLW3 ④ 02⑤-②
	Full Voltage	1NO-1NC 2NO 2NC	ALW39911⑤-②-③ ALW39920⑤-②-③ ALW39902⑤-②-③	AOLW39911⑤-②-③ AOLW39920⑤-②-③ AOLW39902⑤-②-③
 Ø 40mm Mushroom Lens	Transformer Type	1NO-1NC 2NO 2NC	ALW4 ④ 11⑤-② ALW4 ④ 20⑤-② ALW4 ④ 02⑤-②	AOLW4 ④ 11⑤-② AOLW4 ④ 20⑤-② AOLW4 ④ 02⑤-②
	Full Voltage	1NO-1NC 2NO 2NC	ALW49911⑤-②-③ ALW49920⑤-②-③ ALW49902⑤-②-③	AOLW49911⑤-②-③ AOLW49920⑤-②-③ AOLW49902⑤-②-③
 Square Extended	Transformer Type	1NO-1NC 2NO 2NC	ALQW2B ④ 11⑤-② ALQW2B ④ 20⑤-② ALQW2B ④ 02⑤-②	AOLQW2B ④ 11⑤-② AOLQW2B ④ 20⑤-② AOLQW2B ④ 02⑤-②
	Full Voltage	1NO-1NC 2NO 2NC	ALQW2B9911⑤-②-③ ALQW2B9920⑤-②-③ ALQW2B9902⑤-②-③	AOLQW2B9911⑤-②-③ AOLQW2B9920⑤-②-③ AOLQW2B9902⑤-②-③



- In place of ②, specify the Lens Color Code (see table above). Mushroom lenses not available in yellow.
- In place of ③, specify the Full Voltage Code (lamp voltage) (see table above).
- In place of ④, specify the Transformer Voltage Code (see table above).
- In place of ⑤, specify the Lamp Type Code from table above.
- For sub-assembly part numbers, see page A3-140.
- For accessories, see page A3-156.
- For dimensions, see page A3-158.

② Lens/LED Color Code

Color	Code
Amber	A
Green	G
Red	R
Blue	S
White	W
Yellow	Y

③ Full Voltage Code

Voltage	Code
6V AC/DC	6V
12V AC/DC	12V
24V AC/DC	24V
120V AC	120V (LED only)
240V AC	240V (LED only)

④ Transformer Voltage Codes

Voltage	Code
120VAC	126
240VAC	246
480VAC	486

⑤ Lamp Type Code

Lamp	Code
Incandescent	Blank
LED	D



Mushroom lenses not available in yellow.



Transformers step down to 6V (use 6V lamp).

Illuminated Pushbuttons (Sub-Assembled)

Transformer/ Adaptor* + Contacts + Lamp Holder + Operator + Lamp + Lens = Complete Part





* Not applicable for full voltage units

Part Numbers: Operators

Style	Part Number	
	Momentary	Maintained
Extended	ALW-0600	AOLW-0600
Extended with Full Shroud	ALFW-0600	AOLFW-0600
ø29mm/ø40mm Mushroom	ALW3-0600	AOLW3-0600
Square/Extended	ALQW-2B0600	AOLQW-2B0600



Part Numbers: Lenses

Style	Part Number	
	Standard	Engravable
Round Extended 	ALW2LU-②	ALW2BLU-②
Ø 29mm Mushroom Head* 	ALW3LU-②	ALW3BLU-②
Ø 40mm Mushroom Head* 	ALW4LU-②	ALW4BLU-②
Square Extended 	—	ALQW2BLU-②



- In place of ②, specify the lens color code from table on the bottom right.
- * Mushroom lens not available in yellow.
- Standard lenses have ribbed pattern, Engravable lenses are smooth and include an engravable insert.



Part Numbers: Lamps

Type	Voltage	Part Number
LED 	6V AC/DC	LSTD-6②
	12V AC/DC	LSTD-1②
	24V AC/DC	LSTD-2②
	120V AC	LSTD-H2②
	240V AC	LSTD-M4②
Incandescent 	6V AC/DC	IS-6
	12V AC/DC	IS-12
	24V AC/DC	IS-24



- In place of ②, specify the LED Color Code.
- The LED contains a current-limiting resistor and a protection diode.

Part Numbers: Lamp Circuit Components



Style	Application	Part Number
Short Lamp Holder 	Used with a Half-size Transformer and one contact block	TW-LH1
Long Lamp Holder 	Used with Full-size Transformer and two contact blocks Used with Half-size Transformer and three contact blocks Used with Full Voltage Adaptor and two contact blocks	TW-LH2
Lead Holder 	Used with TW-LH2 holder when using four contact blocks	HW-LH3

② LED/Lens Color Code

Color	Code
Amber	A
Green	G
Red	R
Blue	S
White	W
Yellow	Y

Illuminated Pushbuttons (Sub-Assembled) con't





Part Numbers: Contact Blocks

Description	Part Number	
	1NO	1NC
Standard Exposed Screw 	HW-C10 HW-C10R (early make)	HW-C01 HW-C01R (late break)
Fingersafe (IP20) 	HW-F10 HW-F10R (early make)	HW-F01 HW-F01R (late break)
Dummy Block 	TW-DB	



1. Dummy blocks (no contacts) are used with an odd number of contact blocks.
2. Use of early and late break contacts creates a make before break function.

Part Numbers: Transformers/Full Voltage Modules

Style	Description	Part Number
Full Size Transformer 	Standard	120V AC TW-T126B
		240V AC TW-T246B
		480V AC TW-T486B
	Fingersafe	120V AC TW-F126B
		240V AC TW-F246B
		480V AC TW-F486B
Half Size Transformer 	120V AC TW-T126SB	
	240V AC TW-T246SB	
Full voltage model (use with even number of contacts) 	Standard TW-DA1B	
	Fingersafe TW-DA1FB	
Full voltage model (use with odd number of contacts) 	Standard HW-DA1B	
	Fingersafe HW-DA1FB	



All Transformers step down to 6V (use 6V lamp).

Non-Illuminated Selector Switches (Assembled)

A3

Switches & Pilot Devices



Assembled Selector Switches

A S W 3 (1) (L) 20 (N) - 304

Function

S: Selector Switch

Series Designation

W: TW Series

Number of Positions

2: 2-Position

3: 3-Position

4: 4-Position

5: 5-Position

Spring Return Action

Blank: Maintained

1: Spring return from Right (2 or 3 position)

2: Spring return from Left (2 or 3 position)

3: 2-Way spring return from Left and Right (3 position only)

Circuit Number

(Standard circuits shown on following pages and A3-150.)

Contacts Terminal Style

Blank: standard

N: Fingersafe (IP20)

Contact Arrangement Code

10: 1NO 01: 1NC

20: 2NO 02: 2NC

40: 4NO 04: 4NC

11: 1NO-1NC 22: 2NO-2NC

Operator Style Code

Blank: Knob Operator

L: Lever Operator

K: Key Operator



1. Use only when interpreting part numbers. Do not use for developing part numbers.
2. Custom contact configurations available, contact IDEC for details.
3. Portions of part number inside () are optional.

Non-Illuminated Selector Switches (Assembled) con't

Part Numbers: 2-Position Selector Switches

Contact	Mounting	Operator Position		Key	Part Number	Part Number	Part Number
		L	R		Maintained	Spring Return from Right	Spring Return from Left
1NO	1 2	0 0	X 0	Knob Lever Key	ASW210 ASW2L10 ASW2K10	ASW2110 ASW21L10 ASW21K10	ASW2210 ASW22L10 ASW22K10
1NC	1 2	X 0	0 0	Knob Lever Key	ASW201-116 ASW2L01-116 ASW2K01-116	ASW2101-116 ASW21L01-116 ASW21K01-116	ASW2201-116 ASW22L01-116 ASW22K01-116
1NO 1NC	1 2	X 0	0 X	Knob Lever Key	ASW211 ASW2L11 ASW2K11	ASW2111 ASW21L11 ASW21K11	ASW2211 ASW22L11 ASW22K11
2NO	1 2	0 0	X X	Knob Lever Key	ASW220 ASW2L20 ASW2K20	ASW2120 ASW21L20 ASW21K20	ASW2220 ASW22L20 ASW22K20
2NC	1 2	X X	0 0	Knob Lever Key	ASW202-104 ASW2L02-104 ASW2K02-104	ASW2102-104 ASW21L02-104 ASW21K02-104	ASW2202-104 ASW22L02-104 ASW22K02-104
2NO 2NC	1 2 3 4	0 X 0 X	X 0 X 0	Knob Lever Key	ASW222 ASW2L22 ASW2K22	ASW2122 ASW21L22 ASW21K22	ASW2222 ASW22L22 ASW22K22
2NO 2NC	1 2 3 4	0 0 X X	X X 0 0	Knob Lever Key	ASW222-111 ASW2L22-111 ASW2K22-111	ASW2122-111 ASW21L22-111 ASW21K22-111	ASW2222-111 ASW22L22-111 ASW22K22-111



A3

Switches & Pilot Devices

Part Numbers: 3-Position Selector Switches

Contact	Mounting	Operator Position			Key	Part Number	Part Number	Part Number	Part Number
		L	C	R		Maintained	Spring Return from Right	Spring Return from Left	Spring Return Two-Way
2NO	1 2	X 0	0 0	0 X	Knob Lever Key	ASW320 ASW3L20 ASW3K20	ASW3120 ASW31L20 ASW31K20	ASW3220 ASW32L20 ASW32K20	ASW3320 ASW33L20 ASW33K20
2NC	1 2	0 X	X X	X 0	Knob Lever Key	ASW302 ASW3L02 ASW3K02	ASW3102 ASW31L02 ASW31K02	ASW3202 ASW32L02 ASW32K02	ASW3302 ASW33L02 ASW33K02
2NO 2NC	1 2 3 4	X 0 0 X	0 X X X	0 X X 0	Knob Lever Key	ASW322 ASW3L22 ASW3K22	ASW3122 ASW31L22 ASW31K22	ASW3222 ASW32L22 ASW32K22	ASW3322 ASW33L22 ASW33K22
2NO 2NC	1 2 3 4	X X 0 0	0 X X 0	X 0 0 X	Knob Lever Key	ASW322-309 ASW3L22-309 ASW3K22-309	ASW3122-309 ASW31L22-309 ASW31K22-309	ASW3222-309 ASW32L22-309 ASW32K22-309	ASW3322-309 ASW33L22-309 ASW33K22-309
2NO 2NC	1 2 3 4	0 0 0 0	X 0 X 0	0 X 0 X	Knob Lever Key	ASW322-310 ASW3L22-310 ASW3K22-310	ASW3122-310 ASW31L22-310 ASW31K22-310	ASW3222-310 ASW32L22-310 ASW32K22-310	ASW3322-310 ASW33L22-310 ASW33K22-310
4NO	1 2 3 4	X X X 0	0 0 0 0	0 X 0 X	Knob Lever Key	ASW340 ASW3L40 ASW3K40	ASW3140 ASW31L40 ASW31K40	ASW3240 ASW32L40 ASW32K40	ASW3340 ASW33L40 ASW33K40
4NC	1 2 3 4	0 X 0 X	X X X X	X 0 X 0	Knob Lever Key	ASW304 ASW3L04 ASW3K04	ASW3104 ASW31L04 ASW31K04	ASW3204 ASW32L04 ASW32K04	ASW3304 ASW33L04 ASW33K04



- The truth table indicates the operating position of contact block when the operator is switched to that position.
X = On (closed contacts)
O = Off (open contacts)
X-X = Overlapping Contacts: Remain on (closed contacts) when switch is moved between these two positions.
- All knob and lever selector switches come in black. Other colors are available by ordering the knob or lever separately.
- Every key selector switch uses an identical key. The key is removable in any maintained position. If a different configuration is required, contact an IDEC representative for more information.
- Custom contact configurations are available, see page A3-150 or contact IDEC for details.

Non-Illuminated Selector Switches (Assembled) con't

Part Numbers: 4-Position Selector Switch

		Operator Position					Maintained Part Number
Contact	Mounting	1	2	3	4		
2NO	1	X	0	0	0	Knob Lever	ASW422-411 ASW4L22-411
2NC	2	0	X	0	0		
	3	0	0	X	0		
	4	0	0	0	X		

Part Numbers: 5-Position Selector Switch

		Operator Position						Maintained Part Number
Contact	Mounting	1	2	3	4	5		
2NO	1	X	0	0	0	0	Knob Lever	ASW522-501 ASW5L22-501
2NC	2	0	X	0	0	0		
	3	0	0	0	X	0		
	4	0	0	0	0	X		

A3
Switches & Pilot Devices



Non-Illuminated Selector Switches (Sub-Assembled)

Contact Blocks + **Operator** + **Knob or Lever*** + **Color Insert*** = **Complete Part†**



- * Not needed with key type switches.
- † Knob type shown.

Part Numbers: Operators

Style	Positions	Description	Part Number	
Knob/Lever 	2	Maintained	ASW200	
		Spring return from right	ASW2100	
		Spring return from left	ASW2200	
	3	Maintained, Cam 1 Maintained, Cam 2 Maintained, Cam 3	ASW300-1	ASW300-1
			ASW300-2	ASW300-2
			ASW300-3	ASW300-3
		Spring return from right, Cam 1 Spring return from right, Cam 2	ASW3100-1	ASW3100-1
			ASW3100-2	ASW3100-2
		Spring return from left, Cam 1 Spring return from left, Cam 2	ASW3200-1	ASW3200-1
	ASW3200-2		ASW3200-2	
4	Maintained, Standard Cam Maintained, Cam 1	ASW3300-1	ASW3300-1	
		ASW3300-2	ASW3300-2	
5	Maintained, Standard cam Maintained, Cam 1	ASW400	ASW400-1	
		ASW500	ASW500-1	
Key 	2	Maintained	ASW2K00	
		Spring return from right	ASW21K00	
		Spring return from left	ASW22K00	
	3	Maintained, Cam 1 Maintained, Cam 2 Maintained, Cam 3	ASW3K00-1	ASW3K00-1
			ASW3K00-2	ASW3K00-2
			ASW3K00-3	ASW3K00-3
		Spring return from right, Cam 1 Spring return from right, Cam 2	ASW31K00-1	ASW31K00-1
			ASW31K00-2	ASW31K00-2
		Spring return from left, Cam 1 Spring return from left, Cam 2	ASW32K00-1	ASW32K00-1
ASW32K00-2	ASW32K00-2			
Spring return from left/right, Cam 1 Spring return from left/right, Cam 2	ASW33K00-1	ASW33K00-1		
	ASW33K00-2	ASW33K00-2		



- Two keys are supplied with every switch, all are keyed alike, and removable from any maintained position. For other configurations, consult your IDEC representative.
- Locking rings are included with all operators. Order knobs, levers, and color inserts separately.
- Different cams produce different contact actions. For details, see contact arrangement charts, page A3-150.

① Handle/Insert Color Code



Color	Code
Black*	B
Blue	S
Green	G
Red	R
Yellow	Y
White†	W

* Color inserts not available in black.
† Knob and lever not available in white.

Part Numbers: Handles and Inserts

Style	Part Number
Knob 	ASWHHY-①
Lever 	ASWHHL-①
Color Insert 	TW-HC1-①

Part Numbers: Contact Blocks

Style	Part Number	
	1NO	1NC
Standard 	HW-C10 HW-C10R (early make)	HW-C01 HW-C01R (late break)
Fingersafe (IP20) 	HW-F10 HW-F10R (early make)	HW-F01 HW-F01R (late break)
Dummy Block 	TW-DB	



- Push rod color code: Green = NO contact block
Red = NC contact block.
- Dummy blocks (no contacts) are used with an odd number of contact blocks.

A3

Switches & Pilot Devices

Illuminated Selector Switches (Assembled)

A3

Switches & Pilot Devices



Assembled Illuminated Selector Switches

A SL W 2 (2) 99 11 (D) (N) - (202) - R - (24V)

Function

SL: Illuminated Selector Switch

Series Designation

W: TW Series

Number of Positions

- 2: 2-Position
- 3: 3-Position

Spring Return Action

- Blank: Maintained
- 1: Spring return from Right
- 2: Spring return from Left
- 3: Two-Way spring return from Left & Right

Illumination Circuit

- 99: Full Voltage (lamp determines voltage)
- 126: 120V AC Step Down Transformer
- 246: 240V AC Step Down Transformer
- 486: 480V AC Step Down Transformer

Lamp Voltage

(Full Voltage Units Only)

- 6V: 6V AC/DC
- 12V: 12V AC/DC
- 24V: 24V AC/DC
- 120V: 120V AC (LED only)
- 240V: 240V AC (LED only)

Lens Color Code

- A: Amber
- G: Green
- R: Red
- S: Blue
- W: White
- Y: Yellow

Contact Circuit No.

Standard circuits are listed on the following pages and A3-150.

Contacts Terminal Style

- Blank: standard
- N: Fingersafe (IP20)

Lamp Type

- Blank: Incandescent
- D: LED

Contact Arrangement Code

- 10: 1NO 01: 1NC
- 20: 2NO 02: 2NC
- 40: 4NO 04: 4NC
- 11: 1NO-1NC 22: 2NO-2NC



1. Use only when interpreting part numbers. Do not use for developing part numbers.
2. All transformers step down to 6V (use 6V lamp).

Illuminated Selector Switches (Assembled) con't

Part Numbers: Illuminated 2-Position Selector Switches

Style				Part Number			
Contact	Mounting	Operator Position		Lamp Circuit Type	Maintained	Spring Return from Right	Spring Return from Left
		L	R				
1NO	1	0	X	Transformer Full Voltage	ASLW2 ① 11④-② ASLW29911④-②-③	ASLW21 ① 11④-② ASLW219911④-②-③	ASLW22 ① 11④-② ASLW229911④-②-③
1NC	2	X	0				
2NO	1	0	X	Transformer Full Voltage	ASLW2 ① 20④-② ASLW29920④-②-③	ASLW21 ① 20④-② ASLW219920④-②-③	ASLW22 ① 20④-② ASLW229920④-②-③
	2	0	X				
2NC	1	X	0	Transformer Full Voltage	ASLW2 ① 02④-104-② ASLW29902④-104-②-③	ASLW21 ① 02④-104-② ASLW219902④-104-②-③	ASLW22 ① 02④-104-② ASLW229902④-104-②-③
	2	X	0				
2NO	1	0	X	Transformer Full Voltage	ASLW2 ① 22④-② ASLW29922④-②-③	ASLW21 ① 22④-② ASLW219922④-②-③	ASLW22 ① 22④-② ASLW229922④-②-③
2NC	2	X	0				
	3	0	X				
	4	X	0				

① Transformer Voltage Code

Voltage	Code
120V AC	126
240V AC	246
480V AC	486



Transformers step down to 6V (use 6V lamp).

② Lens Color Code

Color	Code	Color	Code
Amber	A	Blue	S
Green	G	White	W
Red	R	Yellow	Y

Part Numbers: Illuminated 3-Position Selector Switches Maintained and Spring Return from Right

Style				Part Number		Part Number		Part Number		Part Number	
Contact	Mounting	Operator Position			Lamp Circuit Type	Maintained	Spring Return From Right	Spring Return from Left	Spring Return Two-Way		
		L	C	R							
2NO	1	X	0	0	Transformer Full Voltage	ASLW3 ① 20④-② ASLW39920④-②-③	ASLW31 ① 20④-② ASLW319920④-②-③	ASLW32 ① 20④-② ASLW329920④-②-③	ASLW33 ① 20④-② ASLW339920④-②-③		
	2	0	0	X							
2NC	1	0	X	X	Transformer Full Voltage	ASLW3 ① 02④-② ASLW39902④-②-③	ASLW31 ① 02④-② ASLW319902④-②-③	ASLW32 ① 02④-② ASLW329902④-②-③	ASLW33 ① 02④-② ASLW339902④-②-③		
	2	X	X	0							
2NO	1	X	0	0	Transformer Full Voltage	ASLW3 ① 22④-② ASLW39922④-②-③	ASLW31 ① 22④-② ASLW319922④-②-③	ASLW32 ① 22④-② ASLW329922④-②-③	ASLW33 ① 22④-② ASLW339922④-②-③		
2NC	2	0	0	X							
	3	0	X	X							
	4	X	X	0							
2NO	1	X	0	X	Transformer Full Voltage	ASLW3 ① 22④-309-② ASLW39922④-309-②-③	ASLW31 ① 22④-309-② ASLW319922④-309-②-③	ASLW32 ① 22④-309-② ASLW329922④-309-②-③	ASLW33 ① 22④-309-② ASLW339922④-309-②-③		
2NC	2	X	X	0							
	3	0	X	0							
	4	0	0	X							
2NO	1	0	X	0	Transformer Full Voltage	ASLW3 ① 22④-310-② ASLW39922④-310-②-③	ASLW31 ① 22④-310-② ASLW319922④-310-②-③	ASLW32 ① 22④-310-② ASLW329922④-310-②-③	ASLW33 ① 22④-310-② ASLW339922④-310-②-③		
2NC	2	0	0	X							
	3	0	X	0							
	4	0	0	X							
4NO	1	X	0	0	Transformer Full Voltage	ASLW3 ① 40④-② ASLW39940④-②-③	ASLW31 ① 40④-② ASLW319940④-②-③	ASLW32 ① 40④-② ASLW329940④-②-③	ASLW33 ① 40④-② ASLW339940④-②-③		
	2	0	0	X							
	3	X	0	0							
	4	0	0	X							
4NC	1	0	X	X	Transformer Full Voltage	ASLW3 ① 04④-② ASLW39904④-②-③	ASLW31 ① 04④-② ASLW319904④-②-③	ASLW32 ① 04④-② ASLW329904④-②-③	ASLW33 ① 04④-② ASLW339904④-②-③		
	2	X	X	0							
	3	0	X	X							
	4	X	X	0							



- In place of ①, specify the Transformer Voltage Code.
- In place of ②, specify the Lens/LED Color Code.
- In place of ③, specify the Full Voltage Code.
- In place of ④ specify Lamp Type Code
- For custom contact configuration, see page A3-150. Contact IDEC for details.

③ Full Voltage Code

Voltage	Code
6V AC/DC	6V
12V AC/DC	12V
24V AC/DC	24V
120V AC	120V (LED only)
240V AC	240V (LED only)

④ Lamp Type Code

Lamp	Code
Incandescent	Blank
LED	D

Illuminated Selector Switches (Sub-Assembled)

Transformer* + Contact Block + Operator + Lamp/Lead Holder † + Lamp + Lens = Complete Part



A3

Switches & Pilot Devices



1. * Full voltage units use a full voltage adaptor (TW-DA1B) instead of a transformer.
2. † Lamp holder is not included with operators, order separately.
Lead holder is used when using 3 or more contact blocks. Order separately.

Part Numbers: Operators

Positions	Description	Part Number
2	Maintained	ASLW200
	Spring return from right	ASLW2100
	Spring return from left	ASLW2200
3	Maintained, cam 1	ASLW300-1
	Maintained, cam 2	ASLW300-2
	Maintained, cam 3	ASLW300-3
	Spring return from right, cam 1	ASLW3100-1
	Spring return from right, cam 2	ASLW3100-2
	Spring return from left, cam 1	ASLW3200-1
Spring return from left, cam 2	ASLW3200-2	
3	Spring return from left/right, cam 1	ASLW3300-1
	Spring return from left/right, cam 2	ASLW3300-2



Different cams produce different contact action. For details, Contact Arrangements on page A3-150.

Part Numbers: Lamps (LED)

Type	Voltage	Part Number
LED	6V AC/DC	LSTD-6②
	12V AC/DC	LSTD-1②
	24V AC/DC	LSTD-2②
	120V AC	LSTD-H2②
	240V AC	LSTD-M4②
Incandescent	6V AC/DC	IS-6
	12V AC/DC	IS-12
	24V AC/DC	IS-24



1. In place of ②, specify the LED Color Code.
2. The LED contains a current-limiting resistor and a protection diodes.

Part Numbers: Lenses (Knobs)

Description	Part Number
Knob	ASLWLU-②





In place of ② specify Lens Color Code.

② LED/Lens Color Code

Color	Code
Amber	A
Green	G
Red	R
Blue	S
White	W
Yellow	Y

Illuminated Selector Switches (Sub-Assembled) con't



Part Numbers: Contact Blocks

Description	Part Number	
	1NO	1NC
Standard 	HW-C10 HW-C10R (early make)	HW-C01 HW-C01R (late break)
Fingersafe (IP20) 	HW-F10 HW-F10R (early make)	HW-F01 HW-F01R (late break)
Dummy Block 	TW-DB	







- Dummy blocks (no contacts) are used with an odd number of contact blocks.
- Use of early and late break contacts creates a make before break function

Part Numbers: Lamp Circuit Components

Style	Application	Part Number
Short Lamp Holder 	Used with a Half-size Transformer and one contact block	TW-LH1
Long Lamp Holder 	Used with a Full-size Transformer and two contact blocks Used w/Half-size Transformer and three contact blocks Used w/Full Voltage Adaptor and two contact blocks	TW-LH2
Lead Holder 	Used w/TW-LH2 holder when using four contact blocks	HW-LH3

Part Numbers: Transformers/Full Voltage Modules

Style	Description	Part Number	
Full Size Transformer 	Standard	120V AC	TW-T126B
		240V AC	TW-T246B
		480V AC	TW-T486B
	Fingersafe	120V AC	TW-F126B
240V AC		TW-F246B	
480V AC		TW-F486B	
Half Size Transformer 	120V AC	TW-T126SB	
	240V AC	TW-T246SB	
Full voltage model (use with even number of contacts) 	Standard	TW-DA1B	
	Fingersafe	TW-DA1FB	
Full voltage model (use with odd number of contacts) 	Standard	HW-DA1B	
	Fingersafe	HW-DA1FB	



All Transformers step down to 6V (use 6V lamp).

Contact Arrangement Charts

How to Read Contact Arrangement Charts

To determine contact block mounting position, first make sure the selector switch is oriented as shown on the right

Switches & Pilot Devices

A3

Contact Arrangement
Type and quantity of switch contacts

Circuit Number
* N/D = No designation required

Contact Block Mounting Position
Position or mounting contact blocks on operator

Operator Position
Truth table indicates the operating position of contact block when operator is switched to that position.

Contact Block Part Number
Part number to use when ordering sub-assembly contact blocks, as required for use with corresponding mounting position

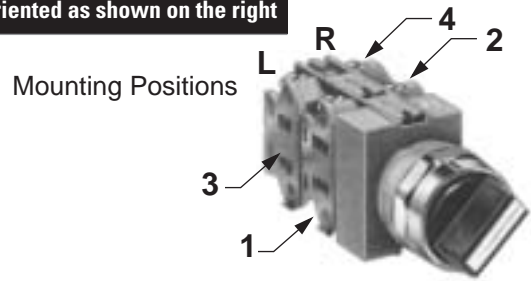

Contact Arrangement Chart: 2-Position Selector Switches

Style	Contact	Circuit Number	Mounting Position	Operator Position		Contact Block Part Number	Description	Operator Part Number															
				L	R			Maintained	Spring Ret. from Rt.	Spring Ret. from Lt.													
1NO	N/D	1	0	X	HW-C10	Knob/Lever Key	ASW200 ASW2K00 ASLW200	ASW2100 ASW21K00 ASLW2100	ASW2200 ASW22K00 ASLW2200														
										2	0	0	TW-DB	ASLW200	ASLW2100	ASLW2200							
1NC	116	1	X	0	HW-C01	Knob/Lever Key	ASW200 ASW2K00 ASLW200	ASW2100 ASW21K00 ASLW2100	ASW2200 ASW22K00 ASLW2200														
										2	0	0	TW-DB	ASLW200	ASLW2100	ASLW2200							
1NO 1NC	N/D	1	0	X	HW-C10	Knob/Lever Key	ASW200 ASW2K00 ASLW200	ASW2100 ASW21K00 ASLW2100	ASW2200 ASW22K00 ASLW2200														
										2	X	0	HW-C01	ASLW200	ASLW2100	ASLW2200							
	103	1	X	0	HW-C01	Knob/Lever Key	ASW200 ASW2K00 ASLW200	ASW2100 ASW21K00 ASLW2100	ASW2200 ASW22K00 ASLW2200														
										2	0	X	HW-C10	ASLW200	ASLW2100	ASLW2200							
1NO-EM 1NC-LB	600	1	0	X	HW-C10R	Knob/Lever Key	ASW200 ASW2K00 ASLW200	ASW2100 ASW21K00 ASLW2100	ASW2200 ASW22K00 ASLW2200														
										2	X	0	HW-C01R	ASLW200	ASLW2100	ASLW2200							
	601	1	X	0	HW-C01R	Knob/Lever Key	ASW200 ASW2K00 ASLW200	ASW2100 ASW21K00 ASLW2100	ASW2200 ASW22K00 ASLW2200														
										2	0	X	HW-C10R	ASLW200	ASLW2100	ASLW2200							
2NO	N/D	1	0	X	HW-C10	Knob/Lever Key	ASW200 ASW2K00 ASLW200	ASW2100 ASW21K00 ASLW2100	ASW2200 ASW22K00 ASLW2200														
										2	0	X	HW-C10	ASLW200	ASLW2100	ASLW2200							
2NC	104	1	X	0	HW-C01	Knob/Lever Key	ASW200 ASW2K00 ASLW200	ASW2100 ASW21K00 ASLW2100	ASW2200 ASW22K00 ASLW2200														
										2	X	0	HW-C01	ASLW200	ASLW2100	ASLW2200							
2NO 2NC	N/D	1	0	X	HW-C10	Knob/Lever Key	ASW200 ASW2K00 ASLW200	ASW2100 ASW21K00 ASLW2100	ASW2200 ASW22K00 ASLW2200														
										2	X	0	HW-C01	ASLW200	ASLW2100	ASLW2200							
																	3	0	X	HW-C10	ASLW200	ASLW2100	ASLW2200
	1	0	X	HW-C10	ASW200 ASW2K00 ASLW200	ASW2100 ASW21K00 ASLW2100	ASW2200 ASW22K00 ASLW2200																
								2	0	X	HW-C10	ASLW200	ASLW2100	ASLW2200									
															3	X	0	HW-C01	ASLW200	ASLW2100	ASLW2200		
																						4	X

1. NO-EM, NC-LB = Early Make, Late Break.
 N/D = No circuit number designation required in assembled selector switch part number.
 2. X = On (closed contacts) O = Off (Open contacts)

Contact Arrangement Chart: 3-Position Selector Switches

Style		Mounting Position	Operator Position			Contact Block Part Number	Description	Operator Part Number				
Contact	Circuit Number		L	C	R			Maintained	Spring Ret. from Rt.	Spring Ret. from Lt.	Two-Way	
1NO 1NC	202	1	X	0	0	HW-C10	Knob/Lever Key Illuminated Knob	ASW300-1 ASW3K00-1 ASLW300-1	ASW3100-1 ASW31K00-1 ASLW3100-1	ASW3200-1 ASW32K00-1 ASLW3200-1	ASW3300-1 ASW33K00-1 ASLW3200-1	
		2	X	X	0	HW-C01		ASW300-1 ASW3K00-1 ASLW300-1	ASW3100-1 ASW31K00-1 ASLW3100-1	ASW3200-1 ASW32K00-1 ASLW3200-1	ASW3300-1 ASW33K00-1 ASLW3200-1	
	203	1	0	X	X	HW-C01	Knob/Lever Key Illuminated Knob	ASW300-1 ASW3K00-1 ASLW300-1	ASW3100-1 ASW31K00-1 ASLW3100-1	ASW3200-1 ASW32K00-1 ASLW3200-1	ASW3300-1 ASW33K00-1 ASLW3200-1	
		2	0	0	X	HW-C10		ASW300-2 ASW3K00-2 ASLW300-2	ASW3100-2 ASW31K00-2 ASLW3100-2	ASW3200-2 ASW32K00-2 ASLW3200-2	ASW3300-2 ASW33K00-2 ASLW3200-2	
	302	1	X	0	X	HW-C10	Knob/Lever Key Illuminated Knob	ASW300-2 ASW3K00-2 ASLW300-2	ASW3100-2 ASW31K00-2 ASLW3100-2	ASW3200-2 ASW32K00-2 ASLW3200-2	ASW3300-2 ASW33K00-2 ASLW3200-2	
		2	X	X	0	HW-C01		ASW300-1 ASW3K00-1 ASLW300-1	ASW3100-1 ASW31K00-1 ASLW3100-1	ASW3200-1 ASW32K00-1 ASLW3200-1	ASW3300-1 ASW33K00-1 ASLW3200-1	
	303	1	0	X	0	HW-C01	Knob/Lever Key Illuminated Knob	ASW300-2 ASW3K00-2 ASLW300-2	ASW3100-2 ASW31K00-2 ASLW3100-2	ASW3200-2 ASW32K00-2 ASLW3200-2	ASW3300-2 ASW33K00-2 ASLW3200-2	
		2	0	0	X	HW-C10		ASW300-1 ASW3K00-1 ASLW300-1	ASW3100-1 ASW31K00-1 ASLW3100-1	ASW3200-1 ASW32K00-1 ASLW3200-1	ASW3300-1 ASW33K00-1 ASLW3200-1	
	2NO	N/D	1	X	0	0	HW-C10	Knob/Lever Key Illuminated Knob	ASW300-1 ASW3K00-1 ASLW300-1	ASW3100-1 ASW31K00-1 ASLW3100-1	ASW3200-1 ASW32K00-1 ASLW3200-1	ASW3300-1 ASW33K00-1 ASLW3200-1
			2	0	0	X	HW-C10		ASW300-2 ASW3K00-2 ASLW300-2	ASW3100-2 ASW31K00-2 ASLW3100-2	ASW3200-2 ASW32K00-2 ASLW3200-2	ASW3300-2 ASW33K00-2 ASLW3200-2
301		1	X	0	X	HW-C10	Knob/Lever Key Illuminated Knob	ASW300-2 ASW3K00-2 ASLW300-2	ASW3100-2 ASW31K00-2 ASLW3100-2	ASW3200-2 ASW32K00-2 ASLW3200-2	ASW3300-2 ASW33K00-2 ASLW3200-2	
		2	0	0	X	HW-C10		ASW300-1 ASW3K00-1 ASLW300-1	ASW3100-1 ASW31K00-1 ASLW3100-1	ASW3200-1 ASW32K00-1 ASLW3200-1	ASW3300-1 ASW33K00-1 ASLW3200-1	
2NC	304	1	0	X	0	HW-C01	Knob/Lever Key Illuminated Knob	ASW300-2 ASW3K00-2 ASLW300-2	ASW3100-2 ASW31K00-2 ASLW3100-2	ASW3200-2 ASW32K00-2 ASLW3200-2	ASW3300-2 ASW33K00-2 ASLW3200-2	
		2	X	X	0	HW-C01		ASW300-1 ASW3K00-1 ASLW300-1	ASW3100-1 ASW31K00-1 ASLW3100-1	ASW3200-1 ASW32K00-1 ASLW3200-1	ASW3300-1 ASW33K00-1 ASLW3200-1	
	N/D	1	0	X	X	HW-C01	Knob/Lever Key Illuminated Knob	ASW300-1 ASW3K00-1 ASLW300-1	ASW3100-1 ASW31K00-1 ASLW3100-1	ASW3200-1 ASW32K00-1 ASLW3200-1	ASW3300-1 ASW33K00-1 ASLW3200-1	
		2	X	X	0	HW-C01		ASW300-2 ASW3K00-2 ASLW300-2	ASW3100-2 ASW31K00-2 ASLW3100-2	ASW3200-2 ASW32K00-2 ASLW3200-2	ASW3300-2 ASW33K00-2 ASLW3200-2	
2NO 2NC	N/D	1	X	0	0	HW-C10	Knob/Lever Key Illuminated Knob	ASW300-1 ASW3K00-1 ASLW300-1	ASW3100-1 ASW31K00-1 ASLW3100-1	ASW3200-1 ASW32K00-1 ASLW3200-1	ASW3300-1 ASW33K00-1 ASLW3200-1	
		2	0	0	X	HW-C10						
		3	0	X	X	HW-C01						
		4	X	X	0	HW-C01						
	210	1	0	X	X	HW-C01	Knob/Lever Key Illuminated Knob	ASW300-1 ASW3K00-1 ASLW300-1	ASW3100-1 ASW31K00-1 ASLW3100-1	ASW3200-1 ASW32K00-1 ASLW3200-1	ASW3300-1 ASW33K00-1 ASLW3200-1	
		2	0	0	X	HW-C10						
		3	0	X	X	HW-C01						
		4	0	0	X	HW-C10						
	308	1	X	0	X	HW-C10	Knob/Lever Key Illuminated Knob	ASW300-2 ASW3K00-2 ASLW300-2	ASW3100-2 ASW31K00-2 ASLW3100-2	ASW3200-2 ASW32K00-2 ASLW3200-2	ASW3300-2 ASW33K00-2 ASLW3200-2	
		2	X	X	0	HW-C01						
		3	X	0	X	HW-C10						
		4	X	X	0	HW-C01						
	309	1	X	0	X	HW-C10	Knob/Lever Key Illuminated Knob	ASW300-2 ASW3K00-2 ASLW300-2	ASW3100-2 ASW31K00-2 ASLW3100-2	ASW3200-2 ASW32K00-2 ASLW3200-2	ASW3300-2 ASW33K00-2 ASLW3200-2	
		2	X	X	0	HW-C01						
		3	0	X	0	HW-C01						
		4	0	0	X	HW-C10						
310	1	0	X	0	HW-C01	Knob/Lever Key Illuminated Knob	ASW300-2 ASW3K00-2 ASLW300-2	ASW3100-2 ASW31K00-2 ASLW3100-2	ASW3200-2 ASW32K00-2 ASLW3200-2	ASW3300-2 ASW33K00-2 ASLW3200-2		
	2	0	0	X	HW-C10							
	3	0	X	0	HW-C01							
	4	0	0	X	HW-C10							
4NO	N/D	1	X	0	0	HW-C10	Knob/Lever Key Illuminated Knob	ASW300-1 ASW3K00-1 ASLW300-1	ASW3100-1 ASW31K00-1 ASLW3100-1	ASW3200-1 ASW32K00-1 ASLW3200-1	ASW3300-1 ASW33K00-1 ASLW3200-1	
		2	0	0	X	HW-C10						
		3	X	0	0	HW-C10						
		4	0	0	X	HW-C10						
	305	1	X	0	X	HW-C10	Knob/Lever Key Illuminated Knob	ASW300-2 ASW3K00-2 ASLW300-2	ASW3100-2 ASW31K00-2 ASLW3100-2	ASW3200-2 ASW32K00-2 ASLW3200-2	ASW3300-2 ASW33K00-2 ASLW3200-2	
		2	0	0	X	HW-C10						
		3	X	0	X	HW-C10						
		4	0	0	X	HW-C10						
4NC	N/D	1	0	X	X	HW-C01	Knob/Lever Key Illuminated Knob	ASW300-1 ASW3K00-1 ASLW300-1	ASW3100-1 ASW31K00-1 ASLW3100-1	ASW3200-1 ASW32K00-1 ASLW3200-1	ASW3300-1 ASW33K00-1 ASLW3200-1	
		2	X	X	0	HW-C01						
		3	0	X	X	HW-C01						
		4	X	X	0	HW-C01						
	314	1	0	X	0	HW-C01	Knob/Lever Key Illuminated Knob	ASW300-2 ASW3K00-2 ASLW300-2	ASW3100-2 ASW31K00-2 ASLW3100-2	ASW3200-2 ASW32K00-2 ASLW3200-2	ASW3300-2 ASW33K00-2 ASLW3200-2	
		2	X	X	0	HW-C01						
		3	0	X	0	HW-C01						
		4	X	X	0	HW-C01						

A3

Switches & Pilot Devices

1. Each operator sub-assembly is available as a "-1" and a "-2" for 3-position selector switches. The internal cam of a "-1" is different from that of a "-2". This results in designated combinations of open and closed contacts in the various operator positions.
 2. N/D = No circuit number designation required in assembled part number.
 3. X = On (closed contacts) O = Off (open contacts). X-X Overlapping contacts remain on (closed) when switch is moved between these two positions.

Custom Selector Switch Building Guide

To build a custom selector switch, follow these steps.

Step 1: How many positions of the switch are needed?

A3

of positions
(2, 3, 4, 5)

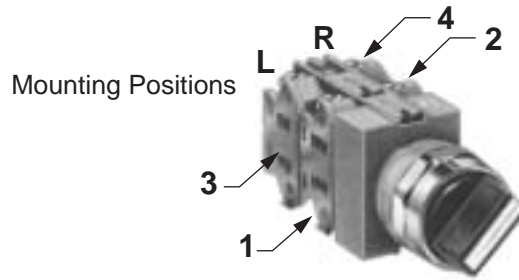

Step 2: How many contacts should there be?

of isolated contacts
(maximum 6)

Step 3: Fill in the Truth Table

(X = closed, 0 = open)

		Knob Position				
		1	2	3	4	5
C o n t a c t s	1					
	2					
	3					
	4					
	5					
	6					

Step 4: If building a 2 position selector, skip this step. (2 position selectors have only one cam)

If building a 3, 4, or 5 position selector, determine appropriate cam as follows:

- Look at Row 1 from above table and locate an identical row in the operator truth tables (See next page).
- Repeat for all rows. The user must find one operator that contains all rows from above table.
- Record the operator cam version.

Operator CAM Version
(-1, -2, -3 for 3 position)
("blank", -1 for 4 position)
("blank", -1 for 5 position)

Step 5: Build by placing appropriate contact in appropriate mounting position for each desired row on operator cam truth table. "L" and "R" refer to mounting on left or right side of operator as viewed from the front of the panel.

Step 6: Develop an assembly part number (if necessary) as follows: follow standard numbering nomenclature for selector switches (see pages A3-142 or A3-146). In place of the "Circuit Number" indicate the cam number and contact arrangement as such ASW322-3-OELCSS, where "3" is the cam number, and contact arrangement "OELCXX" calls out individual contact mounting locations in order (see diagram above). O=NO, C=NC, E=NO-EM, L=NC-LB, X= no contact. Part number must designate all 6 possible mounting locations.

Caution: Before putting any custom selector switch into use, the user should use an ohmmeter to test for desired performance.



1. For Operator Truth Tables, see next page.
2. For examples of how to assemble selector switches, see A3-82.

Operator Truth Tables

Use the following tables to build custom selector switches.

2 Position Selector Switches

Contact	Mounting Position	Operator Position	
		Left	Right
HW-C10 (NO)	L	0	X
	R	0	X
HW-C01 (NC)	L	X	0
	R	X	0
HW-C10R (NO-EM)	L	0	X
	R	0	X
HW-C01R (NC-LB)	L	X	0
	R	X	0

ASW200
ASLW200
ASW2K00

4 Position Selector Switches

Contact	Mounting Position	Operator Position			
		1	2	3	4
HW-C10 (NO)	L	X	0	0	0
	R	0	X	0	0
HW-C01 (NC)	L	0	X	X	X
	R	X	0	X	X
HW-C10R (NO-EM)	L	X	0	0	0
	R	0	X	0	0
HW-C01R (NC-LB)	L	0	X	X	X
	R	X	0	X	X

ASW400

3 Position Selector Switches

Contact	Mounting Position	Operator Position		
		Left	Center	Right
HW-C10 (NO)	L	X	0	0
	R	0	0	X
HW-C01 (NC)	L	0	X	X
	R	X	X	0
HW-C10R (NO-EM)	L	X	0	0
	R	0	0	X
HW-C01R (NC-LB)	L	0	X	X
	R	X	X	0

ASW300-1
ASW3K00-1
ASLW300-1

Contact	Mounting Position	Operator Position			
		1	2	3	4
HW-C10 (NO)	L	X	0	0	0
	R	0	0	0	X
HW-C01 (NC)	L	0	0	X	0
	R	0	X	0	0
HW-C10R (NO-EM)	L	X	X	0	X
	R	X	0	X	X
HW-C01R (NC-LB)	L	0	X	X	X
	R	X	X	X	0

ASW400-1

5 Position Selector Switches

Contact	Mounting Position	Operator Position		
		Left	Center	Right
HW-C10 (NO)	L	X	0	X
	R	0	0	X
HW-C01 (NC)	L	0	X	0
	R	X	X	0
HW-C10R (NO-EM)	L	X	0	X
	R	0	0	X
HW-C01R (NC-LB)	L	0	X	0
	R	X	X	0

ASW300-2
ASW3K00-2
ASLW300-2

Contact	Mounting Position	Operator Position				
		1	2	3	4	5
HW-C10 (NO)	L	X	0	0	0	0
	R	0	X	0	0	0
HW-C01 (NC)	L	0	0	X	X	X
	R	0	0	0	X	X
HW-C10R (NO-EM)	L	X	0	0	0	0
	R	0	X	0	0	0
HW-C01R (NC-LB)	L	0	X	X	X	X
	R	X	0	X	X	X

ASW500

Contact	Mounting Position	Operator Position		
		Left	Center	Right
HW-C10 (NO)	L	X	0	0
	R	0	0	X
HW-C01 (NC)	L	0	X	0
	R	0	X	0
HW-C10R (NO-EM)	L	X	0	X
	R	X	0	X
HW-C01R (NC-LB)	L	0	X	X
	R	X	X	0

ASW300-3
ASW3K00-3
ASLW300-3

Contact	Mounting Position	Operator Position				
		1	2	3	4	5
HW-C10 (NO)	L	X	0	0	0	0
	R	0	0	0	0	X
HW-C01 (NC)	L	0	0	0	X	0
	R	0	X	0	0	0
HW-C10R (NO-EM)	L	X	X	X	0	X
	R	X	0	X	X	X
HW-C01R (NC-LB)	L	0	X	X	X	X
	R	X	X	X	X	0

ASW500-1

Nameplates — TW Series

Part Numbers: Nameplates

A3

Switches & Pilot Devices

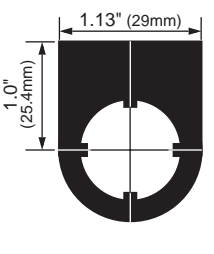
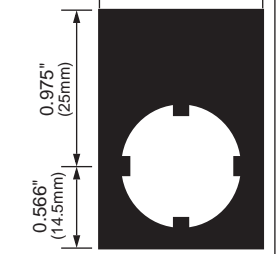
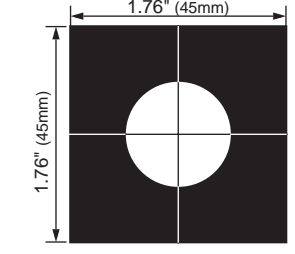
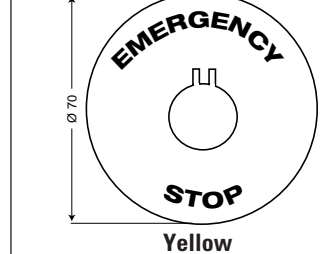
	NWAL	NWAQL	NWAS	EMERGENCY STOP
				
	Part Number	Part Number	Part Number	Part Number
Nameplate (blank)	NWAL-OB (black) NWAL-OR (red)	NWAQL-OB (black) NWAQL-OR (red)	NWAS-OB	NWAR-0
Nameplate (engraved)	NWAL-①	NWAQL-①	NWAS-①	NWAR-27 [†]

- 1. In place of ①, insert either the Standard Legend Code from table below or custom engraving delimited by “ “.
- 2. Standard engravings are available at no charge.
- 3. NWAR-27 comes marked “Emergency Stop” as shown in drawing.

Standard Legend Codes

Pushbuttons				Pushbuttons/Selector Switches				Selector Switches	
Legend	Code	Legend	Code	Legend	Code	Legend	Code	Legend	Code
AUTO	101	OPEN	116	AUTO-MAN	201			AUTO-MAN-OFF	301
CLOSE	102	OUT	117	CLOSE-OPEN	202			AUTO-OFF-MAN	302
DOWN	103	RAISE	118	DOWN-UP	203			CLOSE-OFF-OPEN	303
EMERG.STOP*	104	RESET	119	FAST-SLOW	204			DOWN-OFF-SLOW	304
FAST	105	REVERSE	120	FOR-REV	205	REV-FOR	216	FAST-OFF-SLOW	305
FORWARD	106	RUN	121	HAND-AUTO	206	RUN-JOG	217	FOR-OFF-REV	306
HAND	107	SLOW	122	HIGH-LOW	207	RUN-SAFE	218	LEFT-OFF-RIGHT	307
HIGH	108	START	123	JOG-RUN	208	SAFE-RUN	219	LOWER-OFF-RAISE	308
IN	109	STOP*	124	LEFT-RIGHT	209	SLOW-FAST	220	OFF-MAN-AUTO	309
INCH	110	STOP	125	LOWER-RAISE	210	START-STOP	221	OFF-SLOW-FAST	310
JOG	111	TEST	126	MAN-AUTO	211	STOP-START	222	OFF-1-2	311
LOW	112	UP	127	OFF-ON	212	UP-DOWN	223	OPEN-OFF-CLOSE	312
LOWER	113	I (Int'l On)	150	ON-OFF	213			SLOW-OFF-FAST	313
OFF	114	O (Int'l Off)	151	OPEN-CLOSE	214			SUMMER-OFF-WINTER	314
ON	115	EMO	152	RAISE-LOWER	215			UP-OFF-DOWN	315
								1-OFF-2	316
								HAND-OFF-AUTO	317

- 1. To order engraved nameplates, add legend code to nameplate part number.
Character height based on the number of characters and size of nameplate. Standard character size is 3/16".
- 2. Nameplates with standard legends are the same list price as blank nameplates.
- 3. * Available in red as standard.

Nameplate Order Form on next page.

Custom Engraved Nameplates Order Form — TW Series

Copy this order form and use it to specify Letter Height, Custom Engravings, Location of Engraving on Nameplate, and Quantity Desired. To insure engraving accuracy, fax it to your IDEC representative, or Distributor.

Your Company Name: _____
 Your Name: _____
 Telephone: _____
 Fax & Email: _____

IDEC Rep/Distributor Contact: _____
 PO number (if known): _____
 IDEC Rep/Distributor Phone: _____
 IDEC Rep/Distributor Fax & Email: _____



Switches & Pilot Devices

NWAL

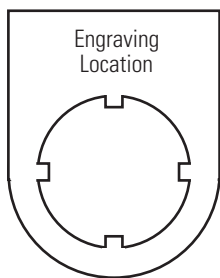

Step 1. Choose Letter Size - 7/64" or 1/8".
 Check the box for the letter size you want. Then write your lettering in box below checkboxes. Note: 1/8" size letters cannot exceed 9 characters.

7/64" Letter Size 11 characters max (for 7/64" size letters)

1/8" Letter Size 9 characters max (for 1/8" size letters)

Step 2. Specify Quantity.
 Enter the number of nameplates desired in the box on the right.

Qty

11 character grid with dashed lines and a vertical dashed line at position 10.

Sample Letter Sizes
 7/64" Letters: A B C D
 1/8" Letters: A B C D

NWAQL

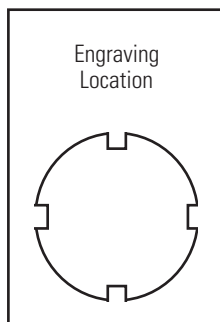

Step 1. Choose Letter Size - 7/64" or 1/8".
 Check the box for the letter size you want. Then write your lettering in box below checkboxes. Note: 1/8" size letters cannot exceed 9 characters.

7/64" Letter Size 11 characters max (for 7/64" size letters)

1/8" Letter Size 9 characters max (for 1/8" size letters)

Step 2. Specify Quantity.
 Enter the number of nameplates desired in the box on the right.

Qty

11 character grid with dashed lines and a vertical dashed line at position 10.

Sample Letter Sizes
 7/64" Letters: A B C D
 1/8" Letters: A B C D

NWAS

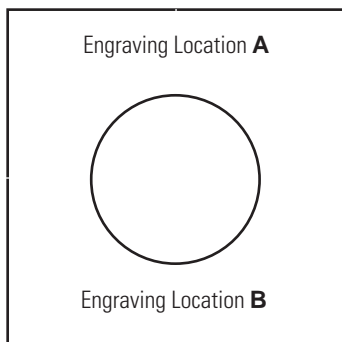

Step 1. Choose Letter Size - 1/8" or 3/32".
 Check the box for the letter size you want. Then write your lettering in box below checkboxes. Note: 1/8" size letters cannot exceed 14 characters.

3/32" Letter Size 20 characters maximum (for 3/32" size letters)

1/8" Letter Size 14 characters maximum (for 1/8" size letters)

Step 2. Specify Quantity.
 Enter the number of nameplates desired in box on the right.

Qty

Step 3. Specify Location.
 Enter the location of engraving (A or B), in box on the right.

Location

Sample Letter Sizes
 3/32" Letters: A B C D
 1/8" Letters: A B C D

20 character grid with dashed lines and a vertical dashed line at position 15.

Accessories — TW Series

Part Numbers: TW Series Accessories





	Appearance	Description/Usage	Part Number
A3 Lamp Removal Tool		Rubber tool used to install LED's and incandescent lamps	OR-55
Contact Block Remover		Used to remove contact blocks, transformers, lenses, and adaptors. Can also be used to determine panel thickness adjustment.	TW-KC1
Nut Locking Wrench		Used in OR-14 locking wrench to tighten locking nuts inside square bezel	TW-KQ2
Metal Bezel		Chrome plated bezels tighten onto operator (replacement for damaged bezels)	Standard octagonal units (chrome-pl.) AW-R8
			Full shroud octagonal units (chrome-pl.) AW-RF8
			Full shroud (chrome plated) mushroom head units Ø 40mm AW-G4
Plastic Bezel		Black plastic bezels for square buttons (replacement for damaged bezels)	Round flush units (black plastic) AW-RP1B
			Round extended units (black plastic) AW-FP1B
			Square units (black plastic) AW-Q1B
			Square bezel with round hole (black plastic) AW-H1B
			Square units with full shroud (black plastic) AW-QF1B
Boot/Cover		Used to cover and protect pushbuttons	Waterproof lens cover for square pilot lights APW00LN
			Waterproof lens cover for square illuminated buttons APW00L
			Clear boot for round flush units (EPR) OC-31
			Clear boot for round extended units (EPR) OC-32
			In place of asterisk, specify Rubber Boot color: B (black), G (green), R (red), Y (yellow) - (nitril rubber) OCW-11
Anti-Rotation Ring		Ring to prevent operator base from rotating in the mounting hole. Used when nameplate is not used	OGL-31
Mounting Hole Plug		Black rubber plug fills unused mounting holes in panel.	OB-31
Metallic Mounting Hole Plug		For plugging unused mounting holes in the panel. Tighten the attached locking ring to a torque of 12 kfg-cm maximum Degree of protection: IP66	LW9Z-BM
Replacement Keys		Pair of keys (#0)	TW-SK



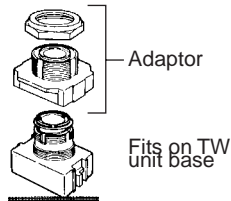

For information on replacement engraving inserts, see page A3-164.

Accessories con't

Part Numbers: TW Series Accessories

Appearance	Description/Usage		Part Number
 <p>Metal Button Guard</p>	Used on flush buttons to prevent inadvertent actuation		OLW-C
 <p>Terminal Tab Adaptor</p>	Quick- connect terminals	#250 (17/64" x 3/64") single tab	TW-FA1
 <p>Lock-out Adaptor</p>	Used to provide lock-out protection for pushbuttons and knob selector switches: • Up to Ø 40mm mushroom head size (Padlock not included.)		HW9Z-KL1
 <p>TW to TWTD Adaptor</p>	Used to mount TW series control unit (except square units) Ø 7/8" (22mm) into a Ø 1-13/64" (30mm) panel cut-out. Includes 2 pieces shown on the right		TWN-A1R8
 <p>Replacement Marking Plates</p>		Round Pushbutton (Ø14mm)	ALW2B
		Round Pilot Light (Ø 14mm)	APW2B
		Mushroom Pushbutton (Ø 14mm)	ALW3B
		Square Pilot Light (□ 21mm)	APQW1B
		Square Pushbutton (□ 21mm)	ALQW2B

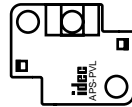
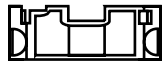
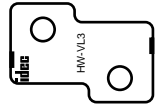
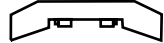
Part Numbers: Fingersafe Covers for TW Series

Appearance	Description	Used with	Part Number
	Fingersafe terminal cover, adds 6mm to overall depth	APW and UPQW full voltage pilot lights	APS-PVL
	Fingersafe terminal cover, adds 3.5mm to overall depth. One required for each contact, only for rear- most terminals	Non-illuminated pushbuttons and selectors	HW-VL2
	Fingersafe terminal cover, adds 3mm to overall depth	APW and UPQW transformer pilot lights, and illuminated pushbuttons and illuminated selectors	HW-VL3
	Fingersafe terminal cover for contacts.	Full voltage illuminated pushbuttons and selectors	HW-VL4
	Fingersafe terminal cover for full voltage adaptor, adds 3 mm to depth	Full voltage illuminated pushbuttons and selectors	HW-VL5
	Fingersafe terminal cover for half size transformer adaptor, adds 3 mm to depth	Illuminated pushbuttons and selectors	HW-VL6

Dimensions — TW Series

Pushbuttons

Flush

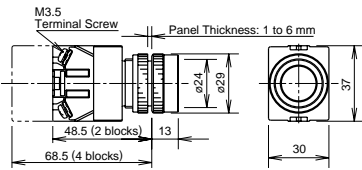

Extended

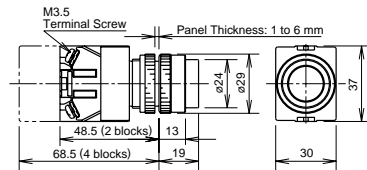

Extended with Full Shroud

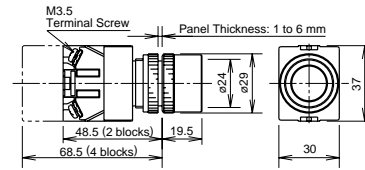

29mm Mushroom

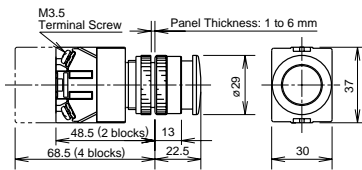

40mm Mushroom

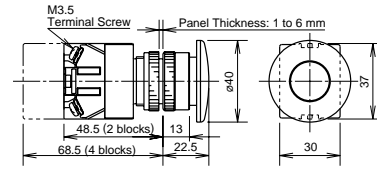

Mushroom with Full Shroud

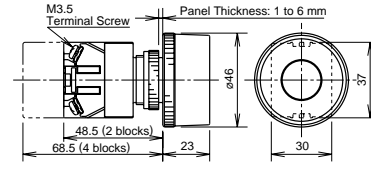

29mm Push-Lock-Turn-Reset

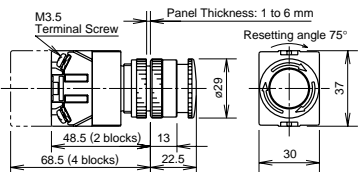

40mm Push-Lock-Turn-Reset

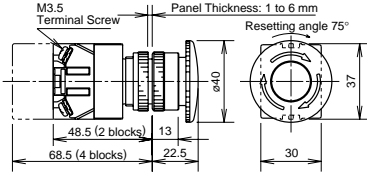

Keylock Push On/Off

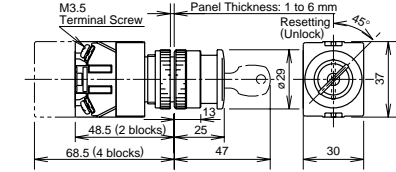

40mm Pushlock Key Reset

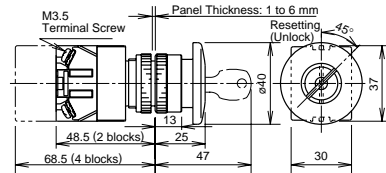

40mm Push-Pull

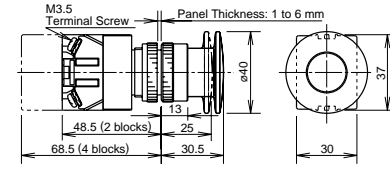

Square Flush

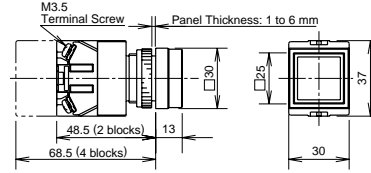

Square Extended

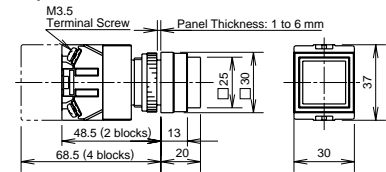

Selector Switches

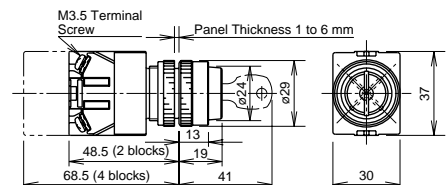
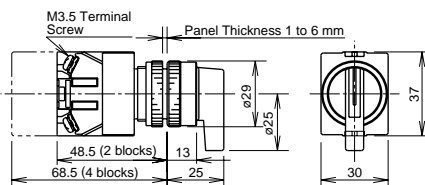
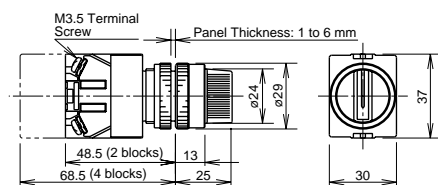

Switches & Pilot Devices

Dimensions con't

Illuminated Pushbuttons

Extended

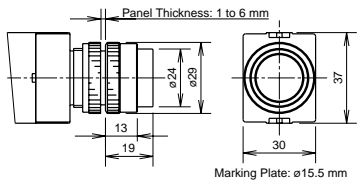

Extended with Full Shroud

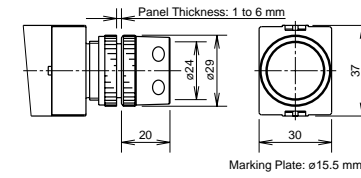

Square Extended

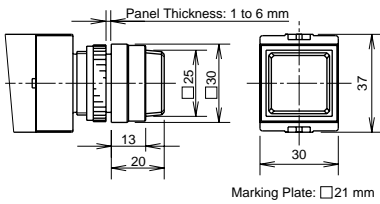

29mm Push-Turn Reset

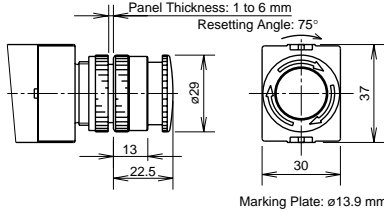

Illuminated Pushbuttons	Dimension A	Dimension B
Extended (Same for Square) w/Full Shroud	0.741" (19mm)	Ø 0.936" (Ø24mm)
	0.761" (19.5mm)	□0.975" (□25mm)
Ø 1.13" (29mm)		
Mushroom	0.858" (22mm)	Ø 1.13" (29mm)
Ø 1.56" (40mm)	0.858" (22mm)	Ø 1.56" (40mm)
Mushroom, Pushlock Turn	*0.936" (24mm)	Ø 1.56" (40mm)
Reset, Push-Pull	† 0.975" (25mm)	Ø 1.56" (40mm)



- * Dimension when operator is in reset position.
- † Dimension when operator is in pull position.

40mm Push-Turn Reset

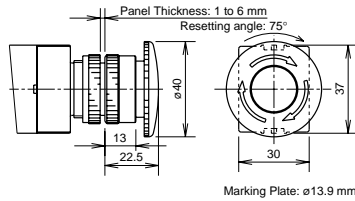

Mushroom

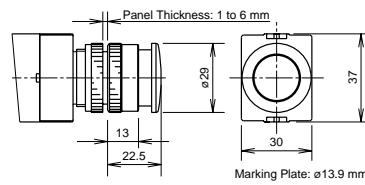

Push-Pull

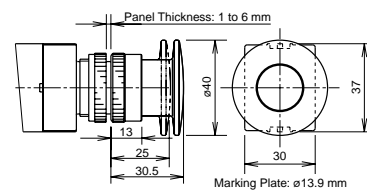

Illuminated Selector Switches

1 Contact Block with Full Voltage Adaptor

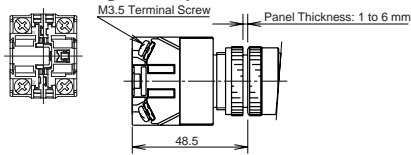

Transformer (2 blocks)

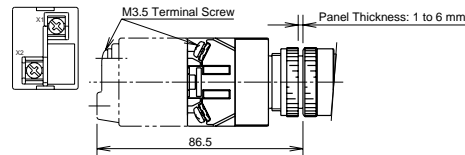

1 Contact Block with Half Size Transformer

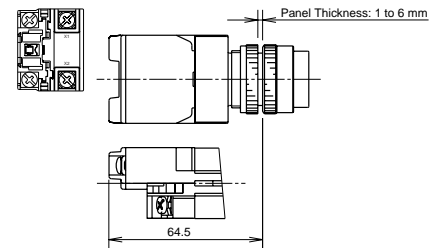

2 Contact Blocks with Full Voltage Adaptor

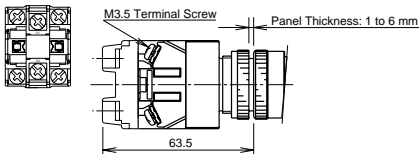

Transformer (4 blocks)

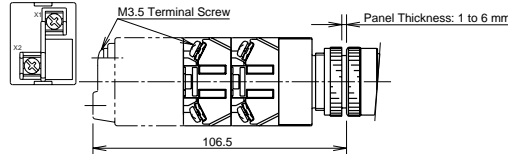

2 Contact Blocks with Half Size Transformer

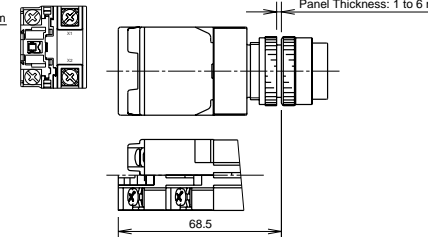

3 Contact Blocks with Full Voltage Adaptor

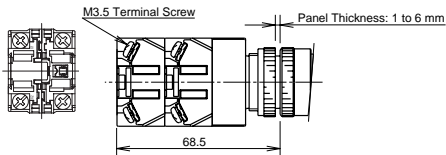

4 Contact Blocks with Full Voltage Adaptor

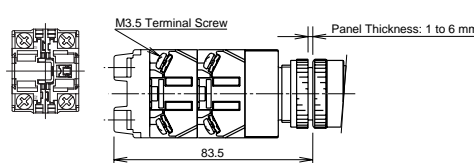

3 Contact Blocks with Half Size Transformer

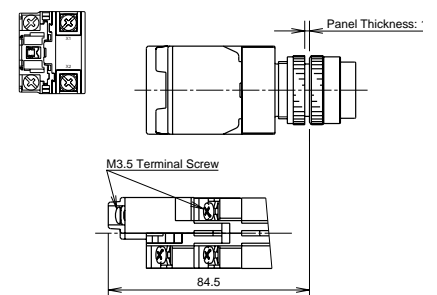

Dimensions con't

Pilot Lights

Round Flush APW1 Full Voltage

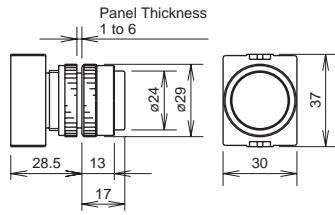

Round Flush APW1 Transformer

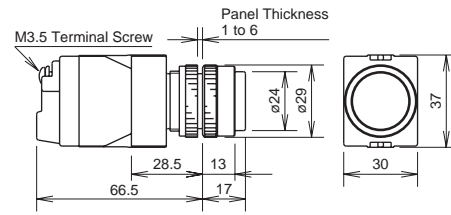

Round Flush Marking Type APW1B Full Voltage

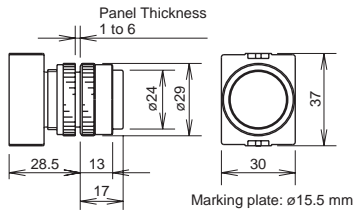

Round Flush Marking Type APW1B Transformer

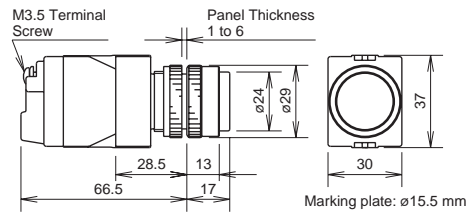

Dome APW2 Full Voltage

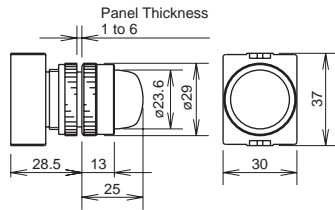

Dome APW2 Transformer

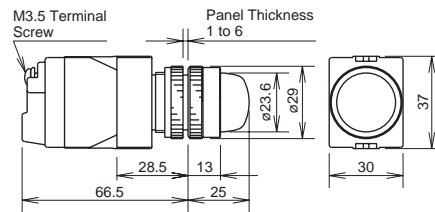

Square Flush Marking Type APQW1B Full Voltage

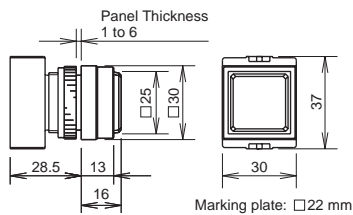

Square Flush Marking Type APQW1B Transformer

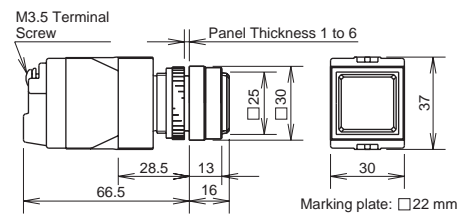

Illuminated Selector Switches

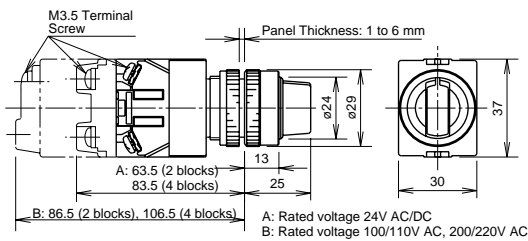

A3

Switches & Pilot Devices

Dimensions con't

Panel Cut-Out

Diagram	Part	Dimensions			
		A	B	C	D
	Pushbuttons	Ø 0.137" (3.5mm)	1.95" (50mm); 1.76" (45mm) minimum	Ø 0.878" (22.3mm)	1.17" (30mm) Std. Octagonal > 1.56" (40mm) Large Mushroom
	Pilot Light				
	Illuminated Pushbutton				
	Selector Switches				
	Illuminated Selector Switches				1.17" (30mm) *See note.



- The Ø 0.137" (Ø 3.5mm) recess is necessary when either the nameplate or anti-rotation ring is used.
- * >1.404" (36mm) for 2- or 3-position.
>1.95" (50mm) for 4- or 5-position.

Accessory Dimensions

OGL-31
Anti-Rotation Ring

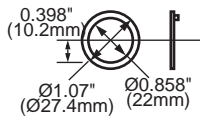

OLW-C
Metal Button Guard

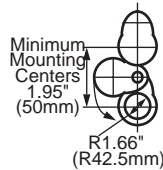

OCW-11
Pushbutton Rubber Boot

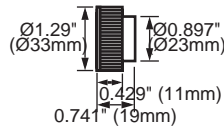

OB-31
Mounting Hole Rubber Plug

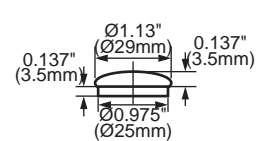

HW9Z-KL1 (TW)
Lock-out Adaptor

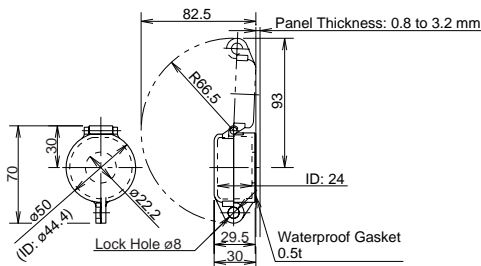

AW-RP1B
Round Plastic Bezel

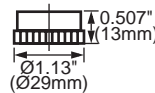

AW-FP1B
Round Plastic w/Full Shroud

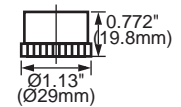

AW-QF1B
Square Full Shroud

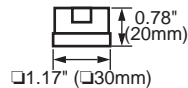

AW-H1B
Square Bezel w/ Round Hole

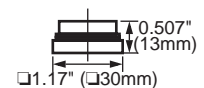

Dimensions con't

Finger-Safe Cover Dimensions

A3

Switches & Pilot Devices

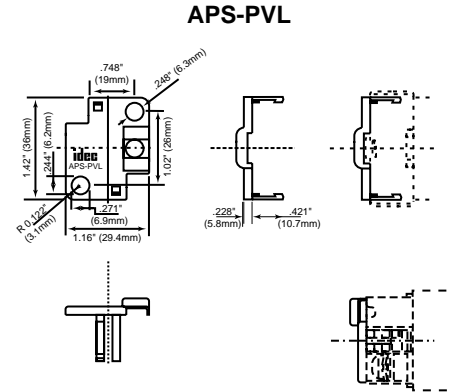
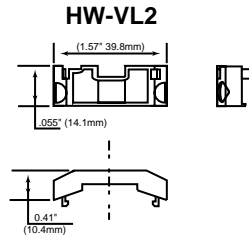
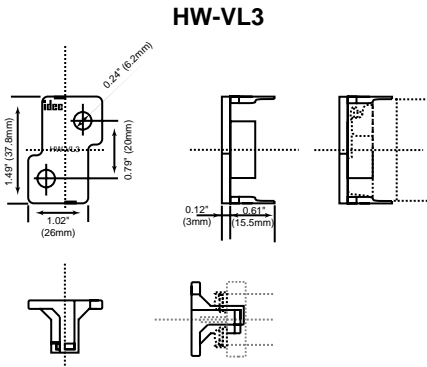
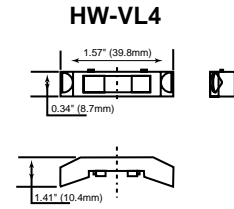
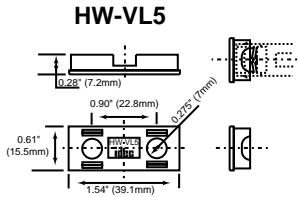
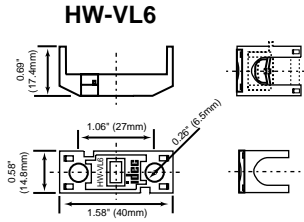

Component Construction & Instructions — TW Series

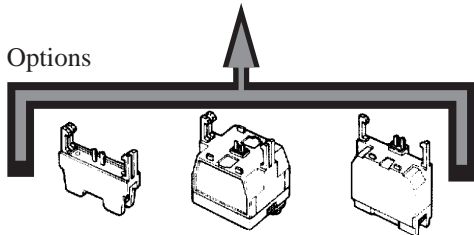
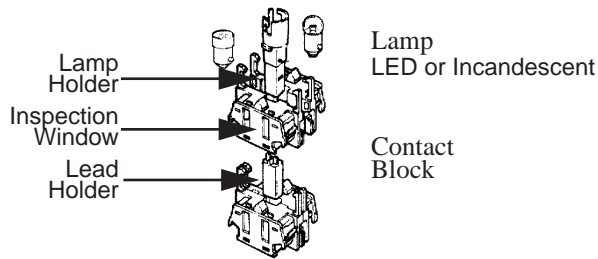
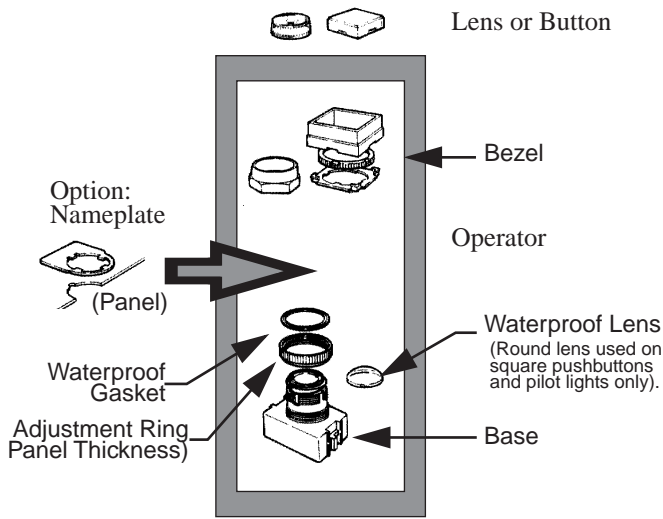

Full Voltage Adaptor:
Used with full voltage LED or incandescent.

Full-Size Transformer:
Used with incandescent/LED – even number of contact blocks.

Half-Size Transformer:
Used with incandescent – odd number of contact blocks.

Instructions for Switches and Pilot Devices

TW Series: Adjustment for Panel Thickness

The panel thickness ring provides adjustment from 0.04" to 0.24" (1 to 6mm) in 0.004" (0.1mm) increments. Rotate the ring until the markings around the periphery are aligned for the desired thickness, as shown below.

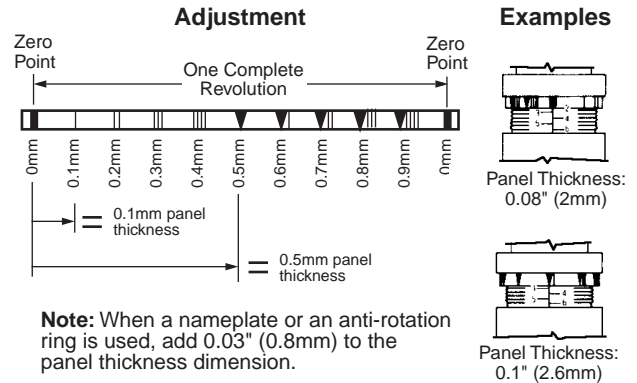

Note: When a nameplate or an anti-rotation ring is used, add 0.03" (0.8mm) to the panel thickness dimension.

An adjustment for panel thicknesses shown below can be made quickly by using the contact block remover tool.

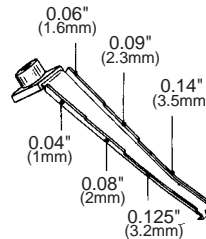

Instructions con't

Pilot Lights and Pushbuttons

IMPORTANT: Install the body of the TW control unit with the panel thickness scale facing up.

A3

Octagonal and Round Bezels

Octagonal and round bezels screw into the operator. Use the locking ring wrench (optional) for secure tightening and easy removal. Round flush and extended buttons snap onto the operator base. Mushroom buttons screw onto the operator base.

Every round lens can be used with or without legend markings. Engraving can be done on a white translucent plate which is placed in the lens, or clear mylar can be printed and placed in the lens.

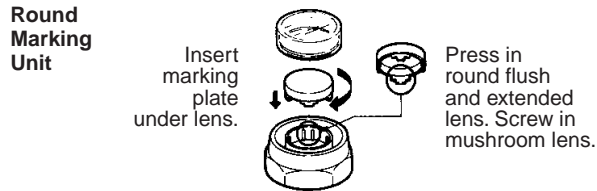

Square Bezels

Square bezels are installed in a 3-step procedure. First install the base plate from the front. Then install the lock nut using the nut locking wrench (optional). Finally, install the square bezel, which snap-fits onto the base plate. Square buttons also snap onto the operator base.

Every square lens can be used with or without legend markings. Engraving can be done on a white translucent plate which is placed in the lens, or clear mylar can be printed and placed in the lens. Square units include a round waterproof lens which screws into the operator. The square outer lens snaps on.

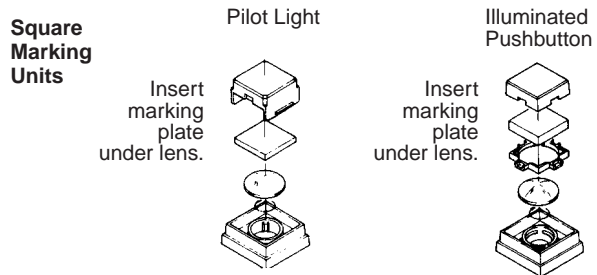

To remove square lens from operator, place a screwdriver under the indentation on the side of the lens. To remove the marking plate, place a screwdriver under the indentation and lift out the plate. The lens retainer can be removed by pressing a 3/16" screwdriver into one of the recesses.



Marking Plate Engraving Area

Shape	Engraving Area	Used With	Part Number
Round	Ø 0.55" (14mm)	Illuminated pushbuttons	ALW2B
	Ø 0.55" (14mm)	Pilot lights	APW2B
Mushroom	Ø 0.55" (14mm)	Illuminated mushroom	ALW3B
Square	□ 0.83" (21mm)	Square pilot lights	APQW1B
Square	□ 0.83" (21mm)	Square illuminated pushbuttons	ALQW2B

Switches & Pilot Devices

Instructions con't

Selector Switches

The operator shaft of each unit has a recess to identify in which direction to install the handle. Align the handle with the recess. Press color insert (TW-HC1) into the handle and then press handle into the operator, as shown below.

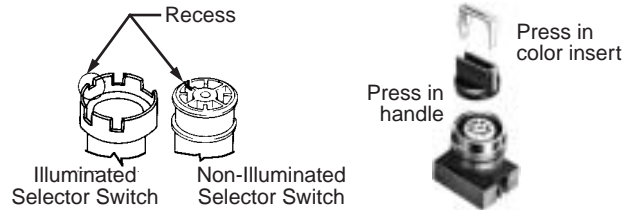

Remove color insert before pulling out the handle.

Standard Operating Positions

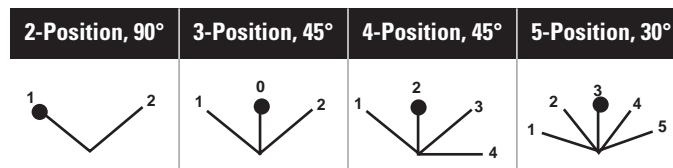

Positions:

Non-illuminated 3-Position Operators

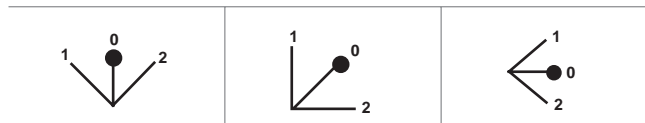

Installation

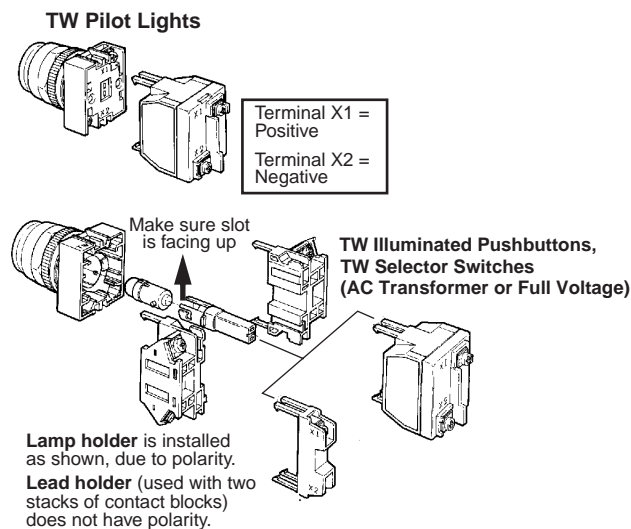

Installation of LED Illuminated Units

AC transformers are recommended for use in areas subjected to inductive noise. When using full voltage types, install a protection diode as shown below. (Diode with DC power supply to protect against surges and noise.)



Make sure that LED illuminated units are installed with correct polarity, as indicated at the terminals.

A4

Switches & Pilot Devices



TWTD Series: Heavy duty switches built to last

Key features include:

- Variety of button sizes up to 2 9/16" (65mm)
- Rugged construction includes chrome plated zinc locking ring die cast zinc mounting threads, screw mounted contact blocks
- LED or incandescent illumination
- Transformer or full voltage
- Transparent contact windows
- Slow make, double break self cleaning contacts
- Modular construction for maximum flexibility
- Double nickel plated terminal screws
- Available assembled or as sub-components
- NEMA 4x and IP65 watertight/oiltight panel
- Large M3.5 screw terminals with captive sems plate

The rugged series of TWTD switches offers both variety and durability in an attractive design.

With button sizes up to 2 9/16" (65mm), chrome plated zinc locking rings, die cast zinc mounting threads, steel anti-rotation rings, and self cleaning contacts, the TWTD's are here to stay.

The TWTD series also offers either LED or incandescent illumination in full voltage and transformer models.

Transparent contact windows allow the viewing of IDEC's self cleaning slow-make/slow-break contacts.

Regardless of your switching needs, the TWTD series provides the kind of long lasting, industrial strength quality you've come to expect from IDEC.



UL Listed
File No. E70646







SA® File No. LR48366



D Ref. No. 117617MC



Certificate No.
2005010305145658

Specifications	Conforming to Standards	EN60947-1, EN60947-5-1, VDE0660-200, UL508, CSA C22-2 No.14
	Approvals	  UL Listed File No. E70646 File No. LR48366   Ref. No. 117617MC
	Operating Temperature	Operation: -25 to +50°C (without freezing) Storage: -40 to +70°C (without freezing)
	Vibration Resistance	10 to 55Hz, 98m/sec ² (10g) conforming to IEC6068-2-6
	Shock Resistance	980m/sec ² (100g) conforming to IEC6068-2-7
	Electric Shock Protection	Class 0 conforming to IEC60536
	Degree of Protection	IP65 (from front of the panel) (conforming to IEC60529) IP54 (key switches) NEMA 1, 2, 3, 3R, 3S, 4, 4X, 5, 12, 13 (conforming to NEMA ICS6-110)
	Mechanical Life	Momentary pushbuttons: 5,000,000 (900 operations per hour) All other switches: 500,000
	Pollution Degree (conforming to IEC60947-1)	3 for switches not using a transformer 2 for switches using a transformer
	Mechanical-Electrical Specifications	Rated Operational Characteristics
Rated Insulation Voltage		600V
Rated Switching Over-Voltage		Less than 4kV, conforming to IEC60947-1
Rated Impulse Withstanding Voltage		4kV for contact circuit 2.5kV for lamp circuit
Rated Thermal Current		10 Amp
Minimum Switching Capacity		5 mA at 3V AC/DC
Contact Operation		Slow break NC or NO, self-cleaning
Operating Force		Flush and extended pushbuttons—with 1NO or 1NC contact: 6.2±2N (momentary), 7.0±2N (maintained) Additional contacts—1NO or 1NC: +3.2N (momentary), + 3.3N (maintained)
Terminal Referencing		Conforming to CENELEC EN50005
Recommended Terminal Torque		0.8 N m (7.1 in lb.)
External Short-Circuit Protection		10A 250V fuse conforming to IEC60269-1
Applicable Wire Size		Minimum 1 x 22 AWG, max. 2 x 14 AWG or 1 x 12 AWG
Contact Resistance		Initial contact resistance of 50mΩ or less
Contact Gap		4mm (NO and NC) 2mm (NO-EM and NC-LB)
Lamp Ratings		Incandescent: 1 W LEDs: 6, 12, 24V: 20mA / 120, 240V: 10mA
Maximum Inrush Current		40 A (40 msec)
Contact Material	Silver	

Contact Ratings	Contact Ratings by Utilization Category IEC 60947-5-1		AC-15 (A600) DC-13 (P600)						
	Contact Ratings by Utilization Category								
	Operational Voltage			24V	48V	50V	110V	220V	440V
	Operation Current	AC 50/60 Hz	AC-12 Control of resistive loads & solid state loads	10A	—	10A	10A	6A	2A
			AC-15 Control of electromagnetic loads (> 72VA)	10A	—	7A	5A	3A	1A
	DC	DC-12 Control of resistive loads & solid state loads	8A	5A	—	2.2A	1.1A	—	
		DC-13 Control of electromagnets	5A	2A	—	1.1A	0.6A	—	

Non-Illuminated Pushbuttons (Assembled)

A4

Switches & Pilot Devices



Assembled Pushbuttons

A B () D 1 10 N - B

<p>Function _____</p> <p>B: Momentary O: Maintained V: Pushlock Turn Reset Y: Push-Pull</p> <p>Bezel Shape _____</p> <p>Blank: Octagonal F: Full Shroud G: Mushroom Shroud P: Neoprene Boot</p> <p>Series Designation _____</p> <p>D: TWTD Series</p>	<p>Button Color</p> <p>B: Black G: Green R: Red S: Blue W: White Y: Yellow</p> <p>Contact Arrangement</p> <p>10: 1NO 01: 1NC 20: 2NO 02: 2NC 11: 1NO-1NC 22: 2NO-2NC</p> <p>Button Shape</p> <p>1: Flush 2: Extended 3: Mushroom Ø 40mm 4: Jumbo Mushroom Ø 65mm</p>
--	--

- 1. Use only when interpreting part numbers. Do not use for developing part numbers.
- 2. Custom contact configurations available, contact IDEC for details.

Non-Illuminated Pushbuttons (Assembled) con't

Part Numbers: Non-Illuminated Pushbuttons

Style	Contacts	Part Number	
		Momentary	Maintained
Flush	1NO 1NC 1NO-1NC 2NO 2NC	ABD110N-① ABD101N-① ABD111N-① ABD120N-① ABD102N-①	AOD110N-① AOD101N-① AOD111N-① AOD120N-① AOD102N-①
Extended	1NO 1NC 1NO-1NC 2NO 2NC	ABD210N-① ABD201N-① ABD211N-① ABD220N-① ABD202N-①	AOD210N-① AOD201N-① AOD211N-① AOD220N-① AOD202N-①
Extended with Neoprene Boot	1NO 1NC 1NO-1NC 2NO 2NC	ABPD210N-① ABPD201N-① ABPD211N-① ABPD220N-① ABPD202N-①	AOPD210N-① AOPD201N-① AOPD211N-① AOPD220N-① AOPD202N-①
Recessed	1NO 1NC 1NO-1NC 2NO 2NC	ABFD110N-① ABFD101N-① ABFD111N-① ABFD120N-① ABFD102N-①	AOFD110N-① AOFD101N-① AOFD111N-① AOFD120N-① AOFD102N-①
Extended with Full Shroud	1NO 1NC 1NO-1NC 2NO 2NC	ABFD210N-① ABFD201N-① ABFD211N-① ABFD220N-① ABFD202N-①	AOFD210N-① AOFD201N-① AOFD211N-① AOFD220N-① AOFD202N-①
Ø 40mm Mushroom Head	1NO 1NC 1NO-1NC 2NO 2NC	ABD310N-① ABD301N-① ABD311N-① ABD320N-① ABD302N-①	AOD310N-① AOD301N-① AOD311N-① AOD320N-① AOD302N-①
Ø 40mm Mushroom Head with Full Shroud	1NO 1NC 1NO-1NC 2NO 2NC	ABGD310N-① ABGD301N-① ABGD311N-① ABGD320N-① ABGD302N-①	AOGD310N-① AOGD301N-① AOGD311N-① AOGD320N-① AOGD302N-①
Ø 65mm Jumbo Mushroom Head	1NO 1NC 1NO-1NC 2NO 2NC	ABD410N-① ABD401N-① ABD411N-① ABD420N-① ABD402N-①	AOD410N-① AOD401N-① AOD411N-① AOD420N-① AOD402N-①
Ø 65mm Jumbo Mushroom Head with Shallow Shroud	1NO 1NC 1NO-1NC 2NO 2NC	ABGD410N-① ABGD401N-① ABGD411N-① ABGD420N-① ABGD402N-①	AOGD410N-① AOGD401N-① AOGD411N-① AOGD420N-① AOGD402N-①
Ø 65mm Jumbo Mushroom Head With Deep Shroud	1NO 1NC 1NO-1NC 2NO 2NC	ABFD410N-① ABFD401N-① ABFD411N-① ABFD420N-① ABFD402N-①	AOFD410N-① AOFD401N-① AOFD411N-① AOFD420N-① AOFD402N-①



1. In place of ①, specify the Button Color Code.
2. For sub-assembly part numbers, see next page.
3. For accessories, see page A4-188.
4. † Neoprene boot available only in Black (B), Green (G), Red (R) and Yellow (Y).

① Button Color Code

Color	Code
Black	B
Green	G
Red	R
Blue	S
White	W
Yellow	Y



1. 65mm Jumbo mushroom not available in white.
2. Neoprene boot is not available in blue or white.







Non-Illuminated Pushbuttons (Sub-Assembled)







A4

Switches & Pilot Devices

Part Numbers: Operators

Style	Part Number	
	Momentary	Maintained
Flush/Extended 	ABD-100	AOD-100
Extended with Full Shroud 	ABFD-200	AOFD-200
Ø 40mm Mushroom/ Ø 65mm Jumbo Mushroom 	ABD-300	AOD-300
Ø 40mm Mushroom with Full Shroud 	ABGD-300	AOGD-300
Ø 65mm Jumbo Mushroom with Shallow Shroud 	ABGD-400	AOGD-400
Ø 65mm Jumbo Mushroom with Deep Shroud 	ABFD-400	AOFD-400

Part Numbers: Buttons and Lenses

Style	Part Number
Flush 	ABD1BN-①
Extended 	ABD2BN-①
Ø 40mm Mushroom 	ABD3BN-①
Ø 65mm Jumbo Mushroom 	ABD4BN-①



In place of ①, specify the Button Color Code. (See table previous page)

Part Numbers: Contact Blocks

Description	Part Number	
	1NO	1NC
	BST-010 BST-010S (early make)	BST-001 BST-001S (late break)
Dummy Block	BST-D	



- Dummy blocks (no contacts) are used with an odd number of contact blocks.
- Combining BST-010S and BST-001S result in overlapping contacts.

E-Stops (Assembled)



A4

Switches & Pilot Devices

Assembled E-Stops

A V (L) D 3 (99) 11 (D) N - R - (24V)

Function

V: Pushlock Turn Reset
Y: Push-Pull

Illumination

Blank: None
L: Illuminated

Series Designation

D: TWTD Series

Button/Lens Size

3: 40mm Mushroom

Illuminated Circuit (illuminated unit only)

99: Full Voltage (lamp determines voltage)
126: 120V AC Step Down Transformer
246: 240V AC Step Down Transformer
486: 480V AC Step Down Transformer

Lamp Voltage

(full voltage illuminated units only)

6V: 6V AC/DC
12V: 12V AC/DC
24V: 24V AC/DC
120V: 120V AC/DC
240V: 240V AC/DC

Button/Lens Color

A: Amber R: Red W: White
G: Green S: Blue Y: Yellow

Lamp Type (illuminated units only)

Blank: Incandescent
D: LED

Contact Arrangement

10: 1NO 01: 1NC
20: 2NO 02: 2NC
11: 1NO/1NC 22: 2NO/2NC



1. Use only when interpreting part numbers. Do not use for developing part numbers.
2. Custom contact configurations available, contact IDEC for details.

E-Stops (Assembled)

Part Numbers: E-Stop Switches

Style	Contacts	Part Number
A4 Ø 40mm Pushlock Turn Reset 	1NO 1NC 1NO-1NC 2NO 2NC	AVD310N-R* AVD301N-R* AVD311N-R* AVD320N-R* AVD302N-R*
Ø 40mm Illuminated Pushlock Turn Reset 	1NO-1NC 2NO 2NC	AVLD39911⑤N-R-③* AVLD39920⑤N-R-③* AVLD39902⑤N-R-③*
Ø 40mm Push-Pull 	1NO 1NC 1NO-1NC 2NO 2NC	AYD310N-① AYD301N-① AYD311N-① AYD320N-① AYD302N-①
Ø 40mm Push-Pull 	1NO-1NC 2NO 2NC	AYLD39911⑤N-②-③** AYLD39920⑤N-②-③** AYLD39902⑤N-②-③**
Ø 40mm Momentary Push-Pull (3-position) 	1NO-1NC 1NC-1LB†	AYLD229911⑤N-②-③-TK962 AYLD229902S⑤N-②-③-TK962
Ø 40mm Momentary Push-Pull (3-position) 	1NO-1NC 1NC-1LB†	AYLD22 ④ 11⑤N-②-TK962 AYLD22 ④ 02S⑤N-②-TK962

3 Position Push-Pull

Contact	Push	Center	Pull
NC (BST-001)	0	0	X
NC-LB (BST-001S)	0	X	X
NO (BST-010)	X	0	0
NO-EM (BST-010S)	X	X	0



- In place of ①, specify the button color code.
- In place of ②, specify the lens color code.
- In place of ③, specify the Full Voltage (lamp voltage) Code.
- In place of ④, specify the transformer voltage code.
- In place of ⑤, specify the Lamp Type code.
- *Available in red only.
- 3 position push-pull available in spring return to center only.
- † The most common configuration for motor starting applications.
- For accessories, see page A4-188.
- For dimensions, see page A4-192.

① Button Color Code

Color	Code
Black	B
Green	G
Red	R
Blue	S
Yellow	Y

② LED Color Codes

Color	Code
Amber	A
Green	G
Red	R
Blue	S
White	W

③ Full Voltage Code

Voltage	Code
6V AC/DC	6V
12V AC/DC	12V
24V AC/DC	24V
120V AC	120V
240V AC	240V (LED only)

④ Transformer Voltage Codes

Voltage	Code
120VAC	126
240VAC	246
480VAC	486



Transformers step down to 6V.

⑤ Lamp Type Code

Lamp	Code
Incandescent	Blank
LED	D

Part Numbers: Unibody E-Stops

Style	Contacts	Part Number
Ø 40mm Pushlock Turn Reset (available in Red only) 	1NO-1NC 2NC	HN1E-BV4F11-R* HN1E-BV4F02-R*
Illuminated Ø 40mm Pushlock Turn Reset (available in Red only) 	1NO-1NC 2NC	HN1E-LV4F11Q⑤-R-③ HN1E-LV4F02Q⑤-R-③



- * Available in Red only.
- **Not available in blue.
- In place of ③, specify Full Voltage Code.
- With single unit construction, the positive action contacts are integrated in the body of the switch. This provides an extra degree of safety and reliability for critical emergency stop functions.
- For nameplates and accessories, see page A3-96.
- For dimensions, see page A3-100.
- For sub-assembly part numbers, see next page.
- HN1E series E-stops comply with EN418, the IEC "E-Stop Addendum to the Low Voltage Directive," this includes "tamper proof" operation whereby a change of contact state is not possible by "teasing" or "floating" the operator.

E-Stops (Sub-Assembled)

Transformer* + Operator + Lamp + Button/Lens = Complete Part



*Not required for full voltage units (full voltage clips used instead).

Part Numbers: Operators

	Style	Part Number
Ø 40mm Pushlock Turn Reset		AVD-300
Illuminated Ø 40mm Pushlock Turn Reset		AVLD3-0600N
Ø 40mm Push-Pull		AYD-3100
Illuminated Ø 40mm Push-Pull		2 pos AYLD-0600
		3 pos AYLD22TK962-0B01

Part Numbers: Buttons and Lenses

	Style	Part No.
Button for Pushlock Turn Reset E-Stop (Ø 40mm, red only)		AVN3B-R
Lens for Illuminated Pushlock Turn Reset E-Stop (Ø 40mm, red only)		AVLN3LU-R
Button for Push-Pull E-Stop (Ø 40mm)		AYD3BN-①
Lens for Illuminated Push-Pull E-Stop (Ø 40mm)		2 pos* AYLD3L-②
		3 pos AYLD2L-②

- In place of ①, specify the Button Color Code. (See table below)
- In place of ②, specify the LED Color Code.
- *Not available in blue.

Part Numbers: Lamps

Type	Voltage	Part Number
LED	6V AC/DC	LSTD-6②
	12V AC/DC	LSTD-1②
	24V AC/DC	LSTD-2②
	120V AC	LSTD-H2②
	240V AC	LSTD-M4②
Incandescent	6V AC/DC	IS-6
	12V AC/DC	IS-12
	24V AC/DC	IS-24
	120VAC	L-120L



- In place of ②, specify the LED color code.
- The LED contains a current-limiting resistor and a protection diode.

① Button Color Code

Color	Code
Black	B
Green	G
Red	R
Blue	S
Yellow	Y

② LED Color Codes

Color	Code
Amber	A
Green	G
Red	R
Blue	S
White	W

Part Numbers: Contact Blocks

Description	Part Number	
	1N0	1NC
All Control Units		
	BST-010	BST-001
	BST-010S (early make)	BST-001S (late break)
	Dummy Blocks	BST-D



- Dummy blocks (no contacts) are used with an odd number of contact blocks.
- Combining BST-010S and BST-001S result in overlapping contacts (remain on, or closed, when switch is moved between two positions).

Part Numbers: Full Voltage Clips

Primary Voltage (50/60Hz)	Part Number
Full Voltage Clips (2 req'd for each unit)	APD-F



Part Numbers: Transformers

Description	Primary Voltage (50/60Hz)	Part Number
	120V AC	TWD-0126
	240V AC	TWD-0246
	480V AC	TWD-0486



6V secondary voltage (uses 6V lamp).

Pilot Lights (Assembled)

A4

Switches & Pilot Devices



Assembled Pilot Lights

A P D 1 126 D N - R - ()

<p>Function P: Pilot Light</p> <p>Series Designation D: TWTD Series</p> <p>Lens Shape 1: Dome</p> <p>Rated Operational Voltage (Primary) Transformer Type 126:120V AC 246:240V AC 486:480V AC</p> <p>Full Voltage Type 99:Full Voltage</p>	<p>Lamp Voltage (Full Voltage Only) 6V: 6V AC/DC 12V:12V AC/DC 24V:24V AC/DC 120V:120V AC 240V: 240V AC (LED only)</p> <p>Lens Color Code A: Amber G: Green R: Red S: Blue W: White Y: Yellow</p> <p>Lamp Type Blank: Incandescent Lamp D: LED Lamp</p>
--	--

Use only when interpreting part numbers. Do not use for developing part numbers.

Part Numbers: LED and Incandescent Pilot Lights

Style	Operating Voltage	Part Number	
		LED	Incandescent
 Transformer Dome	120V AC 240V AC 480V AC	APD1126DN-② APD1246DN-② APD1486DN-②	APD1126N-② APD1246N-② APD1486N-②
 Full Voltage Dome	—	APD199DN-②-③	APD199N-②-③

② Lens Color Code

Color	Code
Amber	A
Green	G
Red	R
Blue	S
White	W
Yellow	Y

③ Full Voltage Code

Voltage	Code
6V AC/DC	6V
12V AC/DC	12V
24V AC/DC	24V
120V AC	120V
240V AC (LED only)	240V

1. In place of ②, specify the Lens/LED Color Code.
2. In place of ③, specify the Full Voltage Code (lamp voltage).



Pilot Lights (Sub-Assembled)

Transformer* + Operator + Lamp + Lens = Complete Part



Note: Not required for full voltage units (full voltage clips used instead).

Part Numbers: Operators

Style	Part Number
Full Voltage 	APD-199
AC Adaptor/Transformer 	APD-006



 The lens, lamp, and transformer/adaptor or the full voltage clips must be ordered separately.

Part Numbers: Lenses

Style	Part Number
Dome Lens 	APN106L-②

 1. In place of ②, specify the Lens Color Code.
2. LED and incandescent lenses differ in shade only. Some colors have only one shade.

Part Numbers: Lamps

Type	Voltage	Part Number
LED 	6V AC/DC	LSTD-6②
	12V AC/DC	LSTD-1②
	24V AC/DC	LSTD-2②
	120V AC	LSTD-H2②
	240V AC	LSTD-M4②
Incandescent 	6.3V AC/DC	IS-6
	12V AC/DC	IS-12
	24V AC/DC	IS-24
	120VAC, 1-8W	L-120L

 1. In place of ②, specify the LED color code.
2. The LED contains a current-limiting resistor and a protection diode.

Part Numbers: Full Voltage Clips

Primary Voltage (50/60Hz)	Part Number
	APD-F

 Required for all full voltage models. Two pieces each.

Part Numbers: Transformers

Description	Primary Voltage (50/60Hz)	Part Number
Transformers 	120V AC	TWD-0126
	240V AC	TWD-0246
	480V AC	TWD-0486

 6V secondary voltage (use 6V lamp).

② Lens/LED Color Code

Color	Code
Amber	A
Green	G
Red	R
Blue	S
White	W
Yellow	Y

A4

Switches & Pilot Devices

Illuminated Pushbuttons (Assembled)



A4

Switches & Pilot Devices

Assembled Illuminated Pushbuttons

A L () D 2 126 11 (D) N - R - ()

Function

L: Momentary Action
OL: Alternate Action

Bezel Shape

Blank: Octagonal
F: Full Shroud

Series Designation

D: TWTD Series

Lens Shape

2: Extended
3: Mushroom Ø 40mm

Rated Operational Voltage (Primary)

Transformer Full Voltage Type
126:120V AC 99:Full Voltage
246:240V AC
486:480V AC

Lamp Voltage (Full Voltage Only)

6V: 6V AC/DC
12V: 12V AC/DC
24V: 24V AC/DC
120V:120V AC
240V: 240V AC (LED only)

Lens Color Code

A: Amber
G: Green
R: Red
S: Blue
W: White
Y: Yellow

Lamp Type

Blank: Incandescent Lamp
D: LED

Contact Arrangement



20: 2NO 02: 2NC
11: 1NO-1NC



1. Use only when interpreting part numbers. Do not use for developing part numbers.
2. All transformers and AC Adaptors step down to 6V.

Illuminated Pushbuttons (Assembled) con't

Part numbers: Illuminated Pushbuttons

Style		Contacts	Part Number	
			Momentary	Maintained
Extended Lens 	Full Voltage	1NO-1NC 2NO 2NC	ALD29911⑤N-②-③ ALD29920⑤N-②-③ ALD29902⑤N-②-③	AOLD29911⑤N-②-③ AOLD29920⑤N-②-③ AOLD29902⑤N-②-③
	Transformer	1NO-1NC 2NO 2NC	ALD2 ④ 11⑤N-② ALD2 ④ 20⑤N-② ALD2 ④ 02⑤N-②	AOLD2 ④ 11⑤N-② AOLD2 ④ 20⑤N-② AOLD2 ④ 02⑤N-②
Extended Lens with Full Shroud 	Full Voltage	1NO-1NC 2NO 2NC	ALFD29911⑤N-②-③ ALFD29920⑤N-②-③ ALFD29902⑤N-②-③	AOLFD29911⑤N-②-③ AOLFD29920⑤N-②-③ AOLFD29902⑤N-②-③
	Transformer	1NO-1NC 2NO 2NC	ALFD2 ④ 11⑤N-② ALFD2 ④ 20⑤N-② ALFD2 ④ 02⑤N-②	AOLFD2 ④ 11⑤N-② AOLFD2 ④ 20⑤N-② AOLFD2 ④ 02⑤N-②
Ø 40mm Mushroom Lens 	Full Voltage	1NO-1NC 2NO 2NC	ALD39911⑤N-②-③ ALD39920⑤N-②-③ ALD39902⑤N-②-③	AOLD39911⑤N-②-③ AOLD39920⑤N-②-③ AOLD39902⑤N-②-③
	Transformer	1NO-1NC 2NO 2NC	ALD3 ④ 11⑤N-② ALD3 ④ 20⑤N-② ALD3 ④ 02⑤N-②	AOLD3 ④ 11⑤N-② AOLD3 ④ 20⑤N-② AOLD3 ④ 02⑤N-②



1. In place of ②, specify the Lens Color Code.
2. In place of ③, specify the Full Voltage Code (lamp voltage).
3. In place of ④, specify the Transformer Voltage Code.
4. In place of ⑤, specify the Lamp Type Code.

② Lens Color Codes

Color	Code
Amber	A
Green	G
Red	R
Blue	S
White	W
Yellow	Y

③ Full Voltage Codes

Voltage	Code
6V AC/DC	6V
12V AC/DC	12V
24V AC/DC	24V
120V AC	120V
240V AC (LED only)	240V

④ Transformer Voltage Codes

Voltage	Code
120VAC	126
240VAC	246
480VAC	486



6V secondary voltage
(uses 6V lamp).

⑤ Lamp Type Code

Lamp	Code
Incandescent	Blank
LED	D

Illuminated Pushbuttons (Sub-Assembled)

Transformer* + Contact Block + Operator + Lamp + Lens = Complete Part

A4

Switches & Pilot Devices



* Not required for full voltage types (full voltage types use APD-F full voltage clips).

Part Numbers: Operators

Style	Part Number	
	Momentary	Maintained
Extended 	ALD-0600	AOLD-0600
Extended with Full Shroud 	ALFD-0600	AOLFD-0600
40mm Mushroom 	ALD-0600	AOLD-0600

Part Numbers: Lamps

Type	Voltage	Part Number
LED 	6V AC/DC	LSTD-6②
	12V AC/DC	LSTD-1②
	24V AC/DC	LSTD-2②
	120V AC	LSTD-H2②
	240V AC	LSTD-M4②
Incandescent 	6V AC/DC	IS-6
	12V AC/DC	IS-12
	24V AC/DC	IS-24
	120VAC	L-120L

② Lens/LED Color Codes

Color	Code
Amber	A
Green	G
Red	R
Blue	S
White	W
Yellow	Y

Mushroom lens not available in yellow.

1. In place of ②, specify the LED Color code.
2. The LED contains a current-limiting resistor and a protection diode.

Part Numbers: Lenses

Style	Part No.
Extended 	ALN06LU-②
Ø 40mm Mushroom 	ALN3LU-②

1. In place of ②, specify the Lens Color Code.
2. LED and incandescent lenses differ in shade only. Some colors have only one shade.

Part Numbers: Contact Blocks

Description	Part Number	
	1N0	1NC
All Control Units 	BST-010 BST-010S (early make)	BST-001 BST-001S (late break)
Dummy Blocks	BST-D	

1. Dummy blocks (no contacts) are used with an odd number of contact blocks.
2. Combining BST-010S and BST-001S result in overlapping contacts (remain on, or closed, when switch is moved between two positions).

Part Numbers: Full Voltage Clips

Primary Voltage (50/60Hz)	Part Number
Full Voltage Clips (2 req'd for each unit) 	APD-F

Required for all full voltage models.

Part Numbers: Transformers

Description	Primary Voltage (50/60Hz)	Part Number
Transformers 	120V AC	TWD-0126
	240V AC	TWD-0246
	480V AC	TWD-0486

6V secondary voltage (uses 6V lamp).

Non-Illuminated Selector Switches (Assembled)



**Knob Selector
(Non-illuminated)**



**Key Selector
(Non-illuminated)**



**Lever Selector
(Non-illuminated)**

A4

Switches & Pilot Devices

Assembled Selector Switches
A S D 2 () () 11 N - ()

<p>Function _____</p> <p>S: Selector Switch</p> <p>Series Designation _____</p> <p>D: TWTD Series</p> <p>Number of Positions _____</p> <p>2: 2-Position 3: 3-Position</p> <p>Spring Return Action _____</p> <p>Blank: Maintained 1: Spring return from Right 2: Spring return from Left 3: 2-Way spring return from Left and Right</p>	<p>Circuit Number _____</p> <p>(See Circuit # column of Selector Switch Contact Arrangement Chart on beginning on A4-185.)</p> <p>Contact Arrangement Code</p> <p>10: 1NO 01: 1NC 20: 2NO 02: 2NC 40: 4NO 04: 4NC 11: 1NO-1NC 22: 2NO-2NC</p> <p>Operator Style Code</p> <p>Blank: Knob Operator L: Lever Operator K: Key Operator</p>
--	---

Use only when interpreting part numbers. Do not use for developing part numbers.

Non-Illuminated Selector Switches (Assembled) con't

Part numbers: Non-Illuminated 2-Position Selector Switches

Style	Contact	Mounting	Operator Position			Part Number	Part Number	Part Number
			L	R		Maintained	Spring Return from Right	Spring Return from Left
	1NO	1 2	0 0	X 0	Knob Lever Key	ASD210N ASD2L10N ASD2K10N	ASD2110N ASD21L10N ASD21K10N	ASD2210N ASD22L10N ASD22K10N
	1NC	1 2	X 0	0 0	Knob Lever Key	ASD201N-116 ASD2L01N-116 ASD2K01N-116	ASD2101N-116 ASD21L01N-116 ASD21K01N-116	ASD2201N-116 ASD22L01N-116 ASD22K01N-116
	1NO 1NC	1 2	0 X	X 0	Knob Lever Key	ASD211N ASD2L11N ASD2K11N	ASD2111N ASD21L11N ASD21K11N	ASD2211N ASD22L11N ASD22K11N
	2NO	1 2	0 0	X X	Knob Lever Key	ASD220N ASD2L20N ASD2K20N	ASD2120N ASD21L20N ASD21K20N	ASD2220N ASD22L20N ASD22K20N
	2NC	1 2	X X	0 0	Knob Lever Key	ASD202N-104 ASD2L02N-104 ASD2K02N-104	ASD2102N-104 ASD21L02N-104 ASD21K02N-104	ASD2202N-104 ASD22L02N-104 ASD22K02N-104
	2NO 2NC	1 2 3 4	0 X 0 X	X 0 X 0	Knob Lever Key	ASD222N ASD2L22N ASD2K22N	ASD2122N ASD21L22N ASD21K22N	ASD2222N ASD22L22N ASD22K22N
	2NO 2NC	1 2 3 4	0 0 X X	X X 0 0	Knob Lever Key	ASD222N-111 ASD2L22N-111 ASD2K22N-111	ASD2122N-111 ASD21L22N-111 ASD21K22N-111	ASD2222N-111 ASD22L22N-111 ASD22K22N-111

Part Numbers: Non-Illuminated 3-Position Selector Switches

Style	Contact	Mounting	Operator Position				Part Number	Part Number	Part Number	Part Number
			L	C	R		Maintained	Spring Return from Right	Spring Return From Left	Spring Return Two-Way
	2NO	1 2	X 0	0 0	0 X	Knob Lever Key	ASD320N ASD3L20N ASD3K20N	ASD3120N ASD31L20N ASD31K20N	ASD3220N ASD32L20N ASD32K20N	ASD3320N ASD33L20N ASD33K20N
	2NC	1 2	0 X	X X	X 0	Knob Lever Key	ASD302N ASD3L02N ASD3K02N	ASD3102N ASD31L02N ASD31K02N	ASD3202N ASD32L02N ASD32K02N	ASD3302N ASD33L02N ASD33K02N
	2NO 2NC	1 2 3 4	X 0 0 X	0 0 X X	0 X X 0	Knob Lever Key	ASD322N ASD3L22N ASD3K22N	ASD3122N ASD31L22N ASD31K22N	ASD3222N ASD32L22N ASD32K22N	ASD3322N ASD33L22N ASD33K22N
	2NO 2NC	1 2 3 4	X X 0 0	0 X X 0	X 0 0 X	Knob Lever Key	ASD322N-309 ASD3L22N-309 ASD3K22N-309	ASD3122N-309 ASD31L22N-309 ASD31K22N-309	ASD3222N-309 ASD32L22N-309 ASD32K22N-309	ASD3322N-309 ASD33L22N-309 ASD33K22N-309
	2NO 2NC	1 2 3 4	0 0 0 0	X X X 0	0 X 0 X	Knob Lever Key	ASD322N-310 ASD3L22N-310 ASD3K22N-310	ASD3122N-310 ASD31L22N-310 ASD31K22N-310	ASD3222N-310 ASD32L22N-310 ASD32K22N-310	ASD3322N-310 ASD33L22N-310 ASD33K22N-310
	4NO	1 2 3 4	X 0 X 0	0 0 0 0	0 X 0 X	Knob Lever Key	ASD340N ASD3L40N ASD3K40N	ASD3140N ASD31L40N ASD31K40N	ASD3240N ASD32L40N ASD32K40N	ASD3340N ASD33L40N ASD33K40N
	4NC	1 2 3 4	0 X 0 X	X X X X	0 0 X 0	Knob Lever Key	ASD304N ASD3L04N ASD3K04N	ASD3104N ASD31L04N ASD31K04N	ASD3204N ASD32L04N ASD32K04N	ASD3304N ASD33L04N ASD33K04N



1. The truth table indicates the operating position of contact block when the operator is switched to that position.

X = On (closed contacts) O = Off (open contacts)

X-X = Overlapping Contacts: Remain on (closed contacts) when switch is moved between these two positions.

2. All knob and lever selector switches come in black. Other colors are available by ordering the knob or lever separately.

3. Custom contact arrangements available, see page A4-185 or call IDEC for details.

Switches & Pilot Devices

A4



Non-Illuminated Selector Switches (Sub-Assembled)

Contact Blocks + Operator + Knob or Lever* + Color Insert* = Complete Part †



- 1. * Not needed with key type switches.
- 2. † Knob type shown.

Part Numbers: Operators

Appearance/ Position	Description	Part Number
Knob & Lever 	2 Maintained	ASD200
	2 Spring-Ret. from Right	ASD2100
	2 Spring-Ret. from Left	ASD2200
	3 Maintained, Cam 1 Maintained, Cam 2	ASD300-1 ASD300-2
	3 Spring-Ret. from Right, Cam1 Spring-Ret. from Right, Cam 2	ASD3100-1 ASD3100-2
	3 Spring-Ret. from Left, Cam 1 Spring-Ret. from Left, Cam 2	ASD3200-1 ASD3200-2
Key 	2 Maintained	ASD2K00-RA
	2 Spring-Ret. from Right	ASD21K00-RL
	2 Spring-Ret. from Left	ASD22K00
	3 Maintained, Cam 1 Maintained, Cam 2	ASD3K00-1-RA ASD3K00-2-RA
	3 Spring-Ret. from Right, Cam1 Spring-Ret. from Right, Cam 2	ASD31K00-1-RLC ASD31K00-2-RLC
	3 Spring-Ret. from Left, Cam 1 Spring-Ret. from Left, Cam 2	ASD32K00-1-RLC ASD32K00-2-RLC
3 Spring-Ret. from L/R, Cam 1 Spring-Ret. from L/R, Cam 2	ASD33K00-1-RC ASD33K00-2-RC	

- 1. Order knobs, levers, color inserts separately (see below).
- 2. For key switches, keys are removable in all maintained positions. Other options available, contact IDEC for details.
- 3. See page A4-187 "Operator Truth Tables" for details of difference between cams.

① Color Codes

Knob/Lever Color	Code
Black	B
Blue	S
Green	G
Red	R
Yellow	Y
White	W

- 1. Knob/Lever not available in white.
- 2. Color inserts not available in Black.

Part Numbers: Handles and Inserts

Style	Part Number
Knob 	ASDHHY - ①
Lever 	ASDHHL - ①
Color Insert 	TW-HC1 - ①

 In place of ①, specify the Color Code.

Part Numbers: Contact Blocks

Style	Part Number	
	1NO	1NC
	BST-010 BST-010S (early make)	BST-001 BST-001S (late break)
Dummy Blocks	BST-D	

- 1. Dummy blocks (no contacts) are used with an odd number of contact blocks.
- 2. Combining BST-010S and BST-001S result in overlapping contacts (remain on, or closed, when switch is moved between two positions).

A4

Switches & Pilot Devices

Illuminated Selector Switches (Assembled)

A4

Switches & Pilot Devices



Assembled Illuminated Selector Switches

A SL D 2 (2) 126 11 D N - 111 - R - 24

Function

SL: Illuminated Selector Switch

Series Designation

D: TWTD Series

Number of Positions

2: 2-Position
3: 3-Position

Spring Return Action

Blank: Maintained
1: Spring return from Right
2: Spring return from Left
3: 2-Way spring return from Left and Right

Rated Operational Voltage (Primary)

Transformer	Full Voltage Type
126:120V AC	99: Full Voltage
246:240V AC	
486:480V AC	

Contact Arrangement

20: 2NO	02: 2NC
40: 4NO	04: 4NC
11: 1NO-1NC	22: 2NO-2NC

Lamp Voltage (Full Voltage Only)

6V: 6V AC/DC
12V: 12V AC/DC
24V: 24V AC/DC
120V: 120V AC
240V: 240V AC (LED only)

Lens Color Code

A: Amber
G: Green
R: Red
S: Blue
W: White
Y: Yellow

Circuit Code Number

See Circuit # column of Selector Switch Contact Arrangement Charts on page A4-185.

Lamp Type

Blank: Incandescent
D: LED



Use only when interpreting part numbers. Do not use for developing part numbers.

Illuminated Selector Switches (Assembled) con't

Part Numbers: Illuminated 2-Position Selector Switches

Contact	Style					Maintained 	Spring Return From Right 	Spring Return From Left
	Mounting	Operator Position						
		L	R					
1NO 1NC	1	0	X	transformer full voltage	ASLD2 ④11⑤N-② ASLD29911⑤N-②-③	ASLD21 ④11⑤N-② ASLD219911⑤N-②-③	ASLD22 ④11⑤N-② ASLD229911⑤N-②-③	
	2	X	0					
2NO	1	0	X	transformer full voltage	ASLD2 ④20⑤N-② ASLD29920⑤N-②-③	ASLD21 ④20⑤N-② ASLD219920⑤N-②-③	ASLD22 ④20⑤N-② ASLD229920⑤N-②-③	
	2	0	X					
2NC	1	X	0	transformer full voltage	ASLD2 ④02⑤N-104-② ASLD29902⑤N-104-②-③	ASLD21 ④02⑤N-104-② ASLD219902⑤N-104-②-③	ASLD22 ④02⑤N-104-② ASLD229902⑤N-104-②-③	
	2	X	0					
2NO 2NC	1	0	X	transformer full voltage	ASLD2 ④22⑤N-② ASLD29922⑤N-②-③	ASLD21 ④22⑤N-② ASLD219922⑤N-②-③	ASLD22 ④22⑤N-② ASLD229922⑤N-②-③	
	2	X	0					
	3	0	X					
	4	X	0					
2NO 2NC	1	0	X	transformer full voltage	ASLD2 ④22⑤N-11-② ASLD29922⑤N-11-②-③	ASLD21 ④22⑤N-11-② ASLD219922⑤N-11-②-③	ASLD22 ④22⑤N-11-② ASLD229922⑤N-11-②-③	
	2	0	X					
	3	X	0					
	4	X	0					

② Lens/LED Color Codes

Color	Code
Amber	A
Green	G
Red	R
Blue	S
White	W
Yellow	Y

③ Full Voltage Codes

Voltage	Code
6V AC/DC	6V
12V AC/DC	12V
24V AC/DC	24V
120V AC	120V
240V AC (LED only)	240V

④ Transformer Voltage Codes

Voltage	Code
120VAC	126
240VAC	246
480VAC	486

⑤ Lamp Type Code

Lamp	Code
Incandescent	Blank
LED	D



6V secondary voltage (uses 6V lamps).

A4

Switches & Pilot Devices

Part Numbers: Illuminated 3-Position Selector Switches

Contact	Style					Maintained 	Spring Return From Right 	Spring Return From Left 	Spring Return Two-Way
	Mounting	Operator Position							
		L	C	R					
2NO	1	X	0	0	transformer full voltage	ASLD3 ④ 20⑤N-② ASLD39920⑤N-②-③	ASLD31 ④ 20⑤N-② ASLD319920⑤N-②-③	ASLD32 ④ 20D⑤N-② ASLD329920D⑤N-②-③	ASLD33 ④ 20D⑤N-② ASLD339920D⑤N-②-③
	2	0	0	X					
2NC	1	0	X	X	transformer full voltage	ASLD3 ④ 02⑤N-② ASLD39902⑤N-②-③	ASLD31 ④ 02⑤N-② ASLD319902⑤N-②-③	ASLD32 ④ 02D⑤N-② ASLD329902D⑤N-②-③	ASLD33 ④ 02D⑤N-② ASLD339902D⑤N-②-③
	2	X	X	0					
2NO 2NC	1	X	0	0	transformer full voltage	ASLD3 ④ 22⑤N-② ASLD39922⑤N-②-③	ASLD31 ④ 22⑤N-② ASLD319922⑤N-②-③	ASLD32 ④ 22D⑤N-② ASLD329922D⑤N-②-③	ASLD33 ④ 22D⑤N-② ASLD339922D⑤N-②-③
	2	0	0	X					
	3	0	X	X					
	4	X	X	0					
2NO 2NC	1	X	0	X	transformer full voltage	ASLD3 ④ 22⑤N-309-② ASLD39922⑤N-309-②-③	ASLD31 ④ 22⑤N-309-② ASLD319922⑤N-309-②-③	ASLD32 ④ 22D⑤N-309-② ASLD329922D⑤N-309-②-③	ASLD33 ④ 22D⑤N-309-② ASLD339922D⑤N-309-②-③
	2	X	X	0					
	3	0	X	0					
	4	0	0	X					
2NO 2NC	1	0	X	0	transformer full voltage	ASLD3 ④ 22⑤N-310-② ASLD39922⑤N-310-②-③	ASLD31 ④ 22⑤N-310-② ASLD319922⑤N-310-②-③	ASLD32 ④ 22D⑤N-310-② ASLD329922D⑤N-310-②-③	ASLD33 ④ 22D⑤N-310-② ASLD339922D⑤N-310-②-③
	2	0	0	X					
	3	0	X	0					
	4	0	0	X					
4NO	1	X	0	0	transformer full voltage	ASLD3 ④ 40⑤N-② ASLD39940⑤N-②-③	ASLD31 ④ 40⑤N-② ASLD319940⑤N-②-③	ASLD32 ④ 40⑤N-② ASLD329940⑤N-②-③	ASLD33 ④ 40⑤N-② ASLD339940⑤N-②-③
	2	0	0	X					
	3	X	0	0					
	4	0	0	X					
4NC	1	0	X	X	transformer full voltage	ASLD3 ④ 04⑤N-② ASLD39904⑤N-②-③	ASLD31 ④ 04⑤N-② ASLD319904⑤N-②-③	ASLD32 ④ 04⑤N-② ASLD329904⑤N-②-③	ASLD33 ④ 04⑤N-② ASLD339904⑤N-②-③
	2	X	X	0					
	3	0	X	X					
	4	X	X	0					



1. In place of ②, specify the Lens/LED Color Code, in place of ③, specify the Full Voltage (lamp voltage) Code, in place of ④, specify the Transformer Voltage Code and in place of ⑤ specify the Lamp Type Code.

2. The truth table indicates the operating position of contact block when the operator is switched to that position.

X = On (Closed Contacts) O = Off (Open Contacts)

—X—X = Overlapping Contacts: Remain on (closed contacts) when switch is moved between these positions

Illuminated Selector Switches (Sub-Assembled)

Transformer* + Contact Block + Operator + Lamp + Lense = Complete Part



A4

Switches & Pilot Devices

*Not required for full voltage units (use APD-F full voltage clips instead).



Part Numbers: Operators

Appearance/ Positions	Description	Part Number
	2 Maintained	ASLD200
	3 Maintained, Cam 1	ASLD300-1
	3 Maintained, Cam 2	ASLD300-2
	2 Spring-Ret. from Right	ASLD2100
	2 Spring-Ret. from Left	ASLD2200
	3 Spring-Ret. from Right, Cam 1	ASLD3100-1
	3 Spring-Ret. from Right, Cam 2	ASLD3100-2
	3 Spring-Ret. from Left, Cam 1	ASLD3200-1
	3 Spring-Ret. from Left, Cam 2	ASLD3200-2
	3 Spring-Ret. from L/R, Cam 1	ASLD3300-1
3 Spring-Ret. from L/R, Cam 2	ASLD3300-2	

Part Numbers: Lenses

Style	Part Number
Knob 	ASLNHU - ①

Part Numbers: Lamps

Type	Voltage	Part Number
	6V AC/DC	LSTD-6②
	12V AC/DC	LSTD-1②
	24V AC/DC	LSTD-2②
	120V AC	LSTD-H2②
	240V AC	LSTD-M4②
	6.3V AC/DC	IS-6
	12V AC/DC	IS-12
	24V AC/DC	IS-24
	120VAC	L-120L

1. In place of ②, specify the LED color code.
 2. The LED contains a current-limiting resistor and a protection diode.

Contact Blocks

Description	Part Number	
	1NO	1NC
	BST-010	BST-001
	BST-010S (early make)	BST-001S (late break)
	Dummy Blocks	BST-D

1. Dummy blocks (no contacts) are used with an odd number of contact blocks.
 2. Combining BST-010S and BST-001S result in overlapping contacts (make before break).

Part Numbers: Full Voltage Clips

Primary Voltage (50/60Hz)	Part Number
Full Voltage Clips (2 req'd for each unit)	APD-F

Part Numbers: Transformers

Description	Primary Voltage (50/60Hz)	Part Number
	120V AC	TWD-0126
	240V AC	TWD-0246
	480V AC	TWD-0486

6V secondary voltage

② Lens/LED Color Codes

Color	Code
Amber	A
Green	G
Red	R
Blue	S
White	W
Yellow	Y

Contact Arrangement Charts

How to Read Contact Arrangement Charts

To determine contact block mounting position, first make sure the selector switch is oriented as shown on the right

Contact Arrangement

Type and quantity of switch contacts

Circuit Number

* N/D = No designation

Contact Block Mounting

Position or mounting contact blocks on operator

Operator Position

Truth table indicates the operating position of contact block when operator is switched to that position.

X = On (Closed Contacts)
O = Off (Open Contacts)
X-X = Overlapping Contacts: Remain on (closed) when switch is moved between these two positions

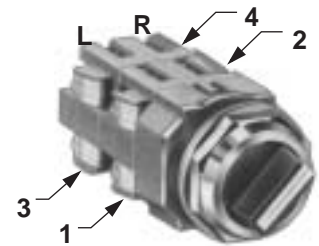

Contact Block Part Number

Part number to use when ordering sub-assembly contact blocks, as required for use with corresponding mounting position

Contact Arrangement Chart: 2-position Selector Switches

Style		Mounting Position	Operator Position		Contact Block Part Number	Description	Operator Part Number		
Contact	Circuit Number		L	R			Maintained	Spring Ret. from Rt.	Spring Ret. from Lt.
			L	R					
			↙	↗		L ↘ R	L ↘ R	L ↘ R	
1NO	N/D	1	O	X	BST-010	Knob/Lever Key	ASD200	ASD2100	ASD2200
		2	O	O	BST-D	Illuminated Knob	ASD2K00	ASD21K00	ASD22K00
1NC	116	1	X	O	BST-001	Knob/Lever Key	ASD200	ASD2100	ASD2200
		2	O	O	BST-D	Illuminated Knob	ASD2K00	ASD21K00	ASD22K00
1NO 1NC	N/D	1	O	X	BST-010	Knob/Lever Key	ASD200	ASD2100	ASD2200
		2	X	O	BST-001	Illuminated Knob	ASD2K00	ASD21K00	ASD22K00
1NO 1NC	103	1	X	O	BST-001	Knob/Lever Key	ASD200	ASD2100	ASD2200
		2	O	X	BST-010	Illuminated Knob	ASD2K00	ASD21K00	ASD22K00
1NO-EM 1NC-LB	600	1	O	X	BST-010S	Knob/Lever Key	ASD200	ASD2100	ASD2200
		2	X	O	BST-001S	Illuminated Knob	ASD2K00	ASD21K00	ASD22K00
1NO-EM 1NC-LB	601	1	X	O	BST-001S	Knob/Lever Key	ASD200	ASD2100	ASD2200
		2	O	X	BST-010S	Illuminated Knob	ASD2K00	ASD21K00	ASD22K00
2NO	N/D	1	O	X	BST-010	Knob/Lever Key	ASD200	ASD2100	ASD2200
		2	O	X	BST-010	Illuminated Knob	ASD2K00	ASD21K00	ASD22K00
2NC	104	1	X	O	BST-001	Knob/Lever Key	ASD200	ASD2100	ASD2200
		2	X	O	BST-001	Illuminated Knob	ASD2K00	ASD21K00	ASD22K00
2NO 2NC	N/D	1	O	X	BST-010	Knob/Lever Key Illuminated Knob	ASD200	ASD2100	ASD2200
		2	X	O	BST-001		ASD2K00	ASD21K00	ASD22K00
		3	O	X	BST-010		ASLD200	ASLD2100	ASLD2200
		4	X	O	BST-001				
	110	1	X	O	BST-001	Knob/Lever Key Illuminated Knob	ASD200	ASD2100	ASD2200
		2	O	X	BST-010		ASD2K00	ASD21K00	ASD22K00
		3	X	O	BST-001		ASLD200	ASLD2100	ASLD2200
		4	O	X	BST-010				
	111	1	O	X	BST-010	Knob/Lever Key Illuminated Knob	ASD200	ASD2100	ASD2200
		2	O	X	BST-010		ASD2K00	ASD21K00	ASD22K00
		3	X	O	BST-001		ASLD200	ASLD2100	ASLD2200
		4	X	O	BST-001				
4NO	N/D	1	O	X	BST-010	Knob/Lever Key Illuminated Knob	ASD200	ASD2100	ASD2200
		2	O	X	BST-010		ASD2K00	ASD21K00	ASD22K00
		3	O	X	BST-010		ASLD200	ASLD2100	ASLD2200
		4	O	X	BST-010				

A4

Switches & Pilot Devices

Contact Arrangement Chart: 3-Position Selector Switches

Style		Mounting Position	Operator Position			Contact Block Part Number	Description	Operator Part Number				
Contact	Circuit Number		L	C	R			Maintained	Spring Ret. from Rt.	Spring Ret. from Lt.	Two-Way	
A4 Switches & Pilot Devices	1NO 1NC	202	1	X	0	0	BST-010	Knob/Lever Key Illuminated Knob	ASD300-1 ASD3K00-1 ASLD300-1	ASD3100-1 ASD31K00-1 ASLD3100-1	ASD3200-1 ASD32K00-1 ASLD3200-1	ASD3300-1 ASD33K00-1 ASLD3300-1
			2	X	X	0	BST-001		ASD300-1 ASD3K00-1 ASLD300-1	ASD3100-1 ASD31K00-1 ASLD3100-1	ASD3200-1 ASD32K00-1 ASLD3200-1	ASD3300-1 ASD33K00-1 ASLD3300-1
		203	1	0	X	X	BST-001	Knob/Lever Key Illuminated Knob	ASD300-1 ASD3K00-1 ASLD300-1	ASD3100-1 ASD31K00-1 ASLD3100-1	ASD3200-1 ASD32K00-1 ASLD3200-1	ASD3300-1 ASD33K00-1 ASLD3300-1
			2	0	0	X	BST-010		ASD300-2 ASD3K00-2 ASLD300-2	ASD3100-2 ASD31K00-2 ASLD3100-2	ASD3200-2 ASD32K00-2 ASLD3200-2	ASD3300-2 ASD33K00-2 ASLD3300-2
		302	1	X	0	X	BST-010	Knob/Lever Key Illuminated Knob	ASD300-2 ASD3K00-2 ASLD300-2	ASD3100-2 ASD31K00-2 ASLD3100-2	ASD3200-2 ASD32K00-2 ASLD3200-2	ASD3300-2 ASD33K00-2 ASLD3300-2
			2	X	X	0	BST-001		ASD300-2 ASD3K00-2 ASLD300-2	ASD3100-2 ASD31K00-2 ASLD3100-2	ASD3200-2 ASD32K00-2 ASLD3200-2	ASD3300-2 ASD33K00-2 ASLD3300-2
	303	1	0	X	0	BST-001	Knob/Lever Key Illuminated Knob	ASD300-2 ASD3K00-2 ASLD300-2	ASD3100-2 ASD31K00-2 ASLD3100-2	ASD3200-2 ASD32K00-2 ASLD3200-2	ASD3300-2 ASD33K00-2 ASLD3300-2	
		2	0	0	X	BST-010		ASD300-1 ASD3K00-1 ASLD300-1	ASD3100-1 ASD31K00-1 ASLD3100-1	ASD3200-1 ASD32K00-1 ASLD3200-1	ASD3300-1 ASD33K00-1 ASLD3300-1	
	2NO	N/D	1	X	0	0	BST-010	Knob/Lever Key Illuminated Knob	ASD300-1 ASD3K00-1 ASLD300-1	ASD3100-1 ASD31K00-1 ASLD3100-1	ASD3200-1 ASD32K00-1 ASLD3200-1	ASD3300-1 ASD33K00-1 ASLD3300-1
			2	0	0	X	BST-010		ASD300-2 ASD3K00-2 ASLD300-2	ASD3100-2 ASD31K00-2 ASLD3100-2	ASD3200-2 ASD32K00-2 ASLD3200-2	ASD3300-2 ASD33K00-2 ASLD3300-2
		301	1	X	0	X	BST-010	Knob/Lever Key Illuminated Knob	ASD300-2 ASD3K00-2 ASLD300-2	ASD3100-2 ASD31K00-2 ASLD3100-2	ASD3200-2 ASD32K00-2 ASLD3200-2	ASD3300-2 ASD33K00-2 ASLD3300-2
			2	0	0	X	BST-010		ASD300-1 ASD3K00-1 ASLD300-1	ASD3100-1 ASD31K00-1 ASLD3100-1	ASD3200-1 ASD32K00-1 ASLD3200-1	ASD3300-1 ASD33K00-1 ASLD3300-1
2NC	304	1	0	X	0	BST-001	Knob/Lever Key Illuminated Knob	ASD300-2 ASD3K00-2 ASLD300-2	ASD3100-2 ASD31K00-2 ASLD3100-2	ASD3200-2 ASD32K00-2 ASLD3200-2	ASD3300-2 ASD33K00-2 ASLD3300-2	
		2	X	X	0	BST-001		ASD300-1 ASD3K00-1 ASLD300-1	ASD3100-1 ASD31K00-1 ASLD3100-1	ASD3200-1 ASD32K00-1 ASLD3200-1	ASD3300-1 ASD33K00-1 ASLD3300-1	
	N/D	1	0	X	X	BST-001	Knob/Lever Key Illuminated Knob	ASD300-1 ASD3K00-1 ASLD300-1	ASD3100-1 ASD31K00-1 ASLD3100-1	ASD3200-1 ASD32K00-1 ASLD3200-1	ASD3300-1 ASD33K00-1 ASLD3300-1	
		2	X	X	0	BST-001		ASD300-1 ASD3K00-1 ASLD300-1	ASD3100-1 ASD31K00-1 ASLD3100-1	ASD3200-1 ASD32K00-1 ASLD3200-1	ASD3300-1 ASD33K00-1 ASLD3300-1	
2NO 2NC	N/D	1	X	0	0	BST-010	Knob/Lever Key Illuminated Knob	ASD300-1 ASD3K00-1 ASLD300-1	ASD3100-1 ASD31K00-1 ASLD3100-1	ASD3200-1 ASD32K00-1 ASLD3200-1	ASD3300-1 ASD33K00-1 ASLD3300-1	
		2	0	0	X	BST-010						
		3	0	X	X	BST-001						
		4	X	X	0	BST-001						
	210	1	0	X	X	BST-001	Knob/Lever Key Illuminated Knob	ASD300-1 ASD3K00-1 ASLD300-1	ASD3100-1 ASD31K00-1 ASLD3100-1	ASD3200-1 ASD32K00-1 ASLD3200-1	ASD3300-1 ASD33K00-1 ASLD3300-1	
		2	0	0	X	BST-010						
		3	0	X	X	BST-001						
		4	0	0	X	BST-010						
	308	1	X	0	X	BST-010	Knob/Lever Key Illuminated Knob	ASD300-2 ASD3K00-2 ASLD300-2	ASD3100-2 ASD31K00-2 ASLD3100-2	ASD3200-2 ASD32K00-2 ASLD3200-2	ASD3300-2 ASD33K00-2 ASLD3300-2	
		2	X	X	0	BST-001						
		3	X	0	X	BST-010						
		4	X	X	0	BST-001						
	309	1	X	0	X	BST-010	Knob/Lever Key Illuminated Knob	ASD300-2 ASD3K00-2 ASLD300-2	ASD3100-2 ASD31K00-2 ASLD3100-2	ASD3200-2 ASD32K00-2 ASLD3200-2	ASD3300-2 ASD33K00-2 ASLD3300-2	
		2	X	X	0	BST-001						
		3	0	X	0	BST-001						
		4	0	0	X	BST-010						
310	1	0	X	0	BST-001	Knob/Lever Key Illuminated Knob	ASD300-2 ASD3K00-2 ASLD300-2	ASD3100-2 ASD31K00-2 ASLD3100-2	ASD3200-2 ASD32K00-2 ASLD3200-2	ASD3300-2 ASD33K00-2 ASLD3300-2		
	2	0	0	X	BST-010							
	3	0	X	0	BST-001							
	4	0	0	X	BST-010							
4NO	N/D	1	X	0	0	BST-010	Knob/Lever Key Illuminated Knob	ASD300-1 ASD3K00-1 ASLD300-1	ASD3100-1 ASD31K00-1 ASLD3100-1	ASD3200-1 ASD32K00-1 ASLD3200-1	ASD3300-1 ASD33K00-1 ASLD3300-1	
		2	0	0	X	BST-010						
		3	X	0	0	BST-010						
		4	0	0	X	BST-010						
	305	1	X	0	X	BST-010	Knob/Lever Key Illuminated Knob	ASD300-2 ASD3K00-2 ASLD300-2	ASD3100-2 ASD31K00-2 ASLD3100-2	ASD3200-2 ASD32K00-2 ASLD3200-2	ASD3300-2 ASD33K00-2 ASLD3300-2	
		2	0	0	X	BST-010						
		3	X	0	X	BST-010						
		4	0	0	X	BST-010						
4NC	N/D	1	0	X	X	BST-001	Knob/Lever Key Illuminated Knob	ASD300-1 ASD3K00-1 ASLD300-1	ASD3100-1 ASD31K00-1 ASLD3100-1	ASD3200-1 ASD32K00-1 ASLD3200-1	ASD3300-1 ASD33K00-1 ASLD3300-1	
		2	X	X	0	BST-001						
		3	0	X	X	BST-001						
		4	X	X	0	BST-001						
	314	1	0	X	0	BST-001	Knob/Lever Key Illuminated Knob	ASD300-2 ASD3K00-2 ASLD300-2	ASD3100-2 ASD31K00-2 ASLD3100-2	ASD3200-2 ASD32K00-2 ASLD3200-2	ASD3300-2 ASD33K00-2 ASLD3300-2	
		2	X	X	0	BST-001						
		3	0	X	0	BST-001						
		4	X	X	0	BST-001						

- Each operator sub-assembly is available as a "-1" and a "-2" for 3-position selector switches. The internal cam of a "-1" is different from that of a "-2". This results in designated combinations of open and closed contacts in the various operator positions.
- N/D = No circuit number designation required in assembled part number.
- X = On (closed contacts) O = Off (open contacts). X-X Overlapping contacts remain on (closed) when switch is moved between these two positions.

Operator Truth Tables

Use the following tables to build custom selector switches.

2 Position Selector Switches

	Contact	Mounting Position	Operator Position	
			Left	Right
ASD200	BST-010 (NO)	L	0	X
		R	0	X
	BST-001 (NC)	L	X	0
		R	X	0
	BST-010S (NO-EM)	L	0	X
		R	0	X
	BST-001S (NC-LB)	L	X	0
		R	X	0

3 Position Selector Switches

	Contact	Mounting Position	Operator Position		
			Left	Center	Right
ASD300-1 ASLD300-1 ASD3K00-1	BST-010 (NO)	L	X	0	0
		R	0	0	X
	BST-001 (NC)	L	0	X	X
		R	X	X	0
	BST-010S (NO-EM)	L	X	0	0
		R	0	0	X
	BST-001S (NC-LB)	L	0	X	X
		R	X	X	0

	Contact	Mounting Position	Operator Position		
			Left	Center	Right
ASD300-2 ASLD300-2 ASD3K00-2	BST-010 (NO)	L	X	0	X
		R	0	0	X
	BST-001 (NC)	L	0	X	0
		R	X	X	0
	BST-010S (NO-EM)	L	X	0	X
		R	0	0	X
	BST-001S (NC-LB)	L	0	X	0
		R	X	X	0













1. For Operator Truth Tables, see next page.
2. For examples of how to assemble selector switches, see A3-82.

3 Position Push/Pull Switches



	Contact	Operator Position		
		Pull	Normal	Push
AYLD22	BST-010 (NO)	0	0	X
	BST-001 (NC)	X	0	0
	BST-010S (NO-EM)	0	X	X
	BST-001S (NC-LB)	X	X	0

Accessories — TWTD Series

Lamp Removal Tool		Tool used to install LED's and incandescent lamps.	OR-55
Metal Bezel		Replacement locking ring/bezel	Standard octagonal units (chrome-pl.). OG-81
			Extended, non-illuminated (chrome-pl.). OG-82
			Extended, illuminated (chrome-pl.). OG-83L
			Jumbo Mushroom Shallow Shroud ABN4G
			Jumbo Mushroom Deep Shroud ABN4F
Plastic Bezel		Black plastic locking ring/bezel	OGP11B
Boot/Cover		Used to cover and protect push-buttons.	In place of ①, specify neoprene Rubber Boot color: B (black), G (green), R (red), Y (yellow) OC-11 ①
			Flush units (clear plastic -40° to +60°C). OC-121
			Extended units (clear plastic -40° to +60°C). OC-122
Anti-Rotation Ring		Plastic washer For nameplates or panels that should not be scratched.	OGL-D1T
		Thrust washer/Anti-rotation ring for use with notched panel cutout.	OGL-D1S
Mounting Hole Plug		Plugs used to fill unused 30mm panel cutouts.	Plastic with locking nut attached. OBP-11
			Metal with locking nut attached OB-11
			Grey rubber (-5° to +60°C) OB-13
Terminal Tab Adaptor		Tab #250 17/64" x 3/64" (6.35mm x 0.8mm): Single tab	TW-FA1
Full Voltage Adaptor		Used on all full voltage illuminated units. Two required per unit. (M3.5 screw and saddle)	APD-F
Lock Out Adaptor		Used to provide lockout protection for TWTD pushbuttons and knob selectors. Ø 1-13/64" (30mm)	OL-KL1
Replacement Keys		Pair of Keys (#0)	TW-SK

Accessories con't

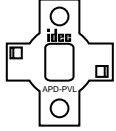
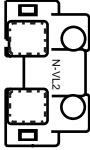
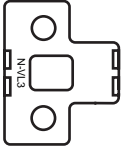
Part Numbers: Fingersafe Covers for TWTD Series

Appearance	Description	Used with	Part Number
	Fingersafe terminal cover, for full voltage pilot lights, adds 3mm to overall depth	APD199... full voltage pilot lights	APD-PVL
	Fingersafe terminal cover, for contact blocks, adds 3mm to overall depth	Non-Illuminated pushbuttons ABD..., and AOD...	N-VL2
	Fingersafe terminal cover, adds 1.5mm to overall depth	Transformer pilot lights and illuminated units	N-VL3
	Fingersafe terminal cover, adds 4 mm to depth	Full voltage illuminated pushbuttons	N-VL4

A4

Switches & Pilot Devices



Dimensions on page A4-192.

Nameplates — TWTD Series

Part Numbers: Nameplates

		NALD	NAKD	NAQD	HNAV
Dimensions					
Description		Part Number	Part Number	Part Number	Part Number
Nameplate (blank)	Black	NALD-B	NAKD-B	NAQD-B	HNAV-0
	Red	NALD-R	NAKD-R	NAQD-R	
Nameplate (engraved)		NALD-①	NAKD-①	NAQD-①	HNAV-27 "Emergency Stop"

1. Nameplates are made of 0.031" aluminum. Lettering is white letters engraved on black background.
2. In place of ①, insert either the standard legend code from table below or custom engraving delimited by " ".
3. HNAV available in yellow only.

* Standard Legend Codes

Pushbuttons				Pushbuttons/Selector Switches				Selector Switches	
Legend	Code	Legend	Code	Legend	Code	Legend	Code	Legend	Code
AUTO	101	OPEN	116	AUTO-MAN	201			AUTO-MAN-OFF	301
CLOSE	102	OUT	117	CLOSE-OPEN	202			AUTO-OFF-MAN	302
DOWN	103	RAISE	118	DOWN-UP	203			CLOSE-OFF-OPEN	303
*EMERG.STOP	104	RESET	119	FAST-SLOW	204			DOWN-OFF-SLOW	304
FAST	105	REVERSE	120	FOR-REV	205	REV-FOR	216	FAST-OFF-SLOW	305
FORWARD	106	RUN	121	HAND-AUTO	206	RUN-JOG	217	FOR-OFF-REV	306
HAND	107	SLOW	122	HIGH-LOW	207	RUN-SAFE	218	LEFT-OFF-RIGHT	307
HIGH	108	START	123	JOG-RUN	208	SAFE-RUN	219	LOWER-OFF-RAISE	308
IN	109	*STOP	124	LEFT-RIGHT	209	SLOW-FAST	220	OFF-MAN-AUTO	309
INCH	110	STOP	125	LOWER-RAISE	210	START-STOP	221	OFF-SLOW-FAST	310
JOG	111	TEST	126	MAN-AUTO	211	STOP-START	222	OFF-1-2	311
LOW	112	UP	127	OFF-ON	212	UP-DOWN	223	OPEN-OFF-CLOSE	312
LOWER	113	I (Int'l On)	150	ON-OFF	213			SLOW-OFF-FAST	313
OFF	114	O (Int'l Off)	151	OPEN-CLOSE	214			SUMMER-OFF-WINTER	314
ON	115	EMO	152	RAISE-LOWER	215			UP-OFF-DOWN	315
								1-OFF-2	316
								HAND-OFF-AUTO	317

1. *Available in Red as standard legend code 104 and 124. To order engraved nameplate and codes, add legend code to nameplate part number. Character height based on the number of characters, space and size of nameplate. Standard character size is 3/16".
2. Nameplates with standard legends are the same list price as blank nameplates. Special engravings, additional cost.

To specify engraving instructions, use the Nameplate order form on next page.

Nameplates Order Form — TWTD Series

Copy this order form and use it to specify Letter Height, Custom Engravings, Location of Engraving on Nameplate, and Quantity Desired. To insure engraving accuracy, fax it to your IDEC representative or Distributor.

Your Company: _____	IDEC Rep/Distributor Contact: _____
Name: _____	PO number (if known): _____
Telephone: _____	IDEC Rep/Distributor Phone: _____
Fax & Email: _____	IDEC Rep/Distributor Fax & Email: _____

A4

NALD Nameplate

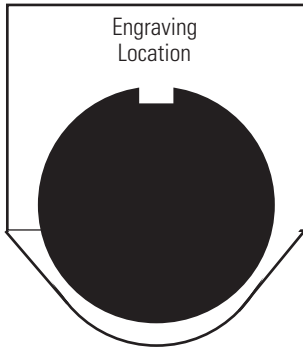

Step 1. Choose Letter Size - 7/64" or 1/8".
Check the box for the letter size you want. Then write your lettering in box below checkboxes. Note: 1/8" size letters cannot exceed 13 characters.

Sample Letter Sizes

7/64" Letters:

A B C D

1/8" Letters:

A B C D

7/64"
Letter
Size

16 characters max
(for 7/64" size letters)

1/8"
Letter
Size

13 characters max
(for 1/8" size letters)

Step 2. Specify Quantity.
Enter the number of nameplates desired in the box on the right.

Qty

12345678910111213141516

Switches & Pilot Devices

NAKD Nameplate

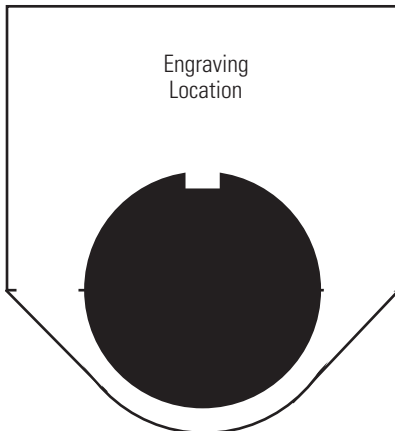

Step 1. 1/8" Letter Size Only Specify Lettering
Write your lettering in box to the right. Maximum 17 characters per line, maximum 4 lines.

1234567891011121314151617

Step 2. Specify Quantity.
Enter the number of nameplates desired in the box on the right.

Qty

Sample Letter Size
1/8" Letters: A B C D

NAQD Nameplate

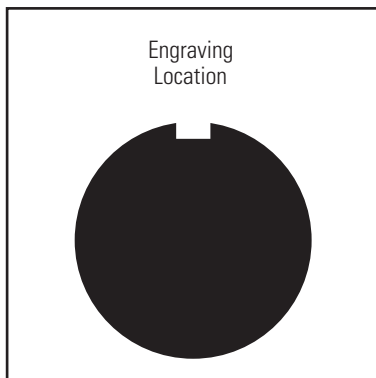

Step 1. Choose Letter Size - 7/64" or 1/8".
Check the box for the letter size you want. Then write your lettering in box below checkboxes. Note: 1/8" size letters cannot exceed 16 characters.

7/64"
Letter
Size

20 characters max
(for 7/64" size letters)

1/8"
Letter
Size

16 characters max
(for 1/8" size letters)

1234567891011121314151617181920

Step 2. Specify Quantity.
Enter the number of nameplates desired in the box on the right.

Qty

Sample Letter Sizes
7/64" Letters: A B C D
1/8" Letters: A B C D

Dimensions — TWTD Series

A4

Switches & Pilot Devices

Pushbutton

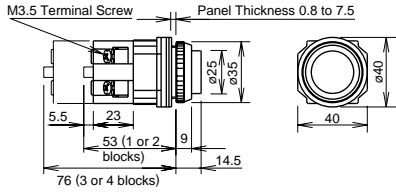

Mushroom Pushbutton w/Full Shroud

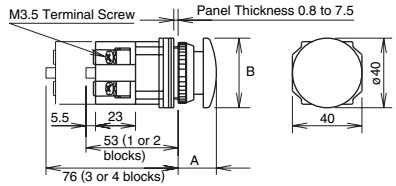

Pushbuttons	Dimension A	Dimension B
Flush	0.351" (9mm)	Ø 0.975" (25mm)
Extended	0.566" (14.5mm)	Ø 0.975" (25mm)
Extended w/Full Shroud	0.663" (17mm)	Ø 1.11" (28.5mm)
Mushroom		
Mushroom w/Full Shroud	0.858" (22mm)	Ø 1.56" (40mm)
Jumbo Mushroom	0.936" (24mm)	Ø 1.87" (48mm)
Ø 1.56" (40mm)	1.13" (29mm)	Ø 2.54" (65mm)
Mushroom, Pushlock Turn Reset and Push-Pull		
Ø 1.56" (40mm)	*0.975" (25mm) **0.975" (25mm)	Ø 1.56" (40mm) Ø 1.56" (40mm)

Note: *Dimension when operator is in reset position.
**Dimension when operator is in pull position.

Illuminated Pushbuttons

w/AC Adapter w/Transformer

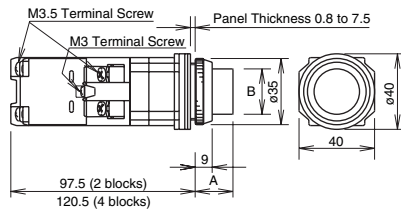

Full Voltage

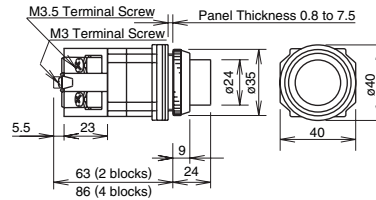

Illuminated Pushbuttons	Dimension A	Dimension B
Flush w/Full Shroud	0.975" (25mm) 0.995" (25.5mm)	Ø 0.936" (24mm) Ø 0.936" (24mm)
Extended w/Full Shroud	0.741" (19mm) 0.761" (19.5mm)	Ø 0.936" (24mm) Ø 0.936" (24mm)
Ø 1.56" (40mm) Mushroom Pushlock Turn Reset, Push-Pull	*0.975" (25mm) **0.975" (25mm)	Ø 1.56" (40mm) Ø 1.56" (40mm)

Note: *Dimension when operator is in reset position.
**Dimension when operator is in pull position.

Pilot Lights

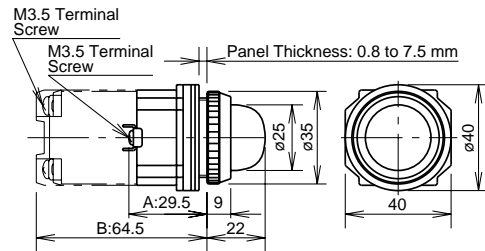

Selector Switches Knob

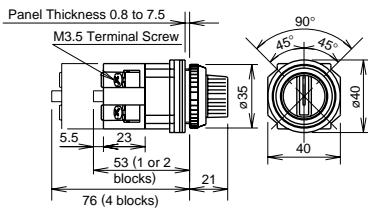

Lever

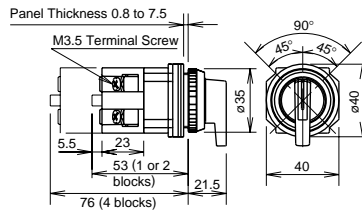

Key

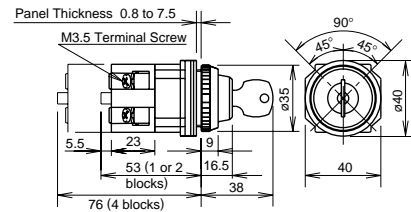

Illuminated Knob

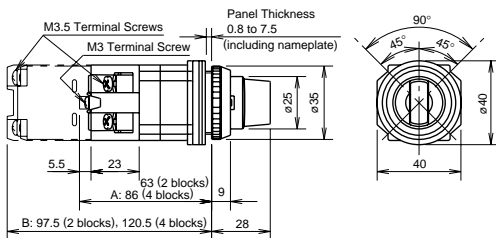

All measurements in mm.

Dimensions — TWTD Series con't

Selector Switches Panel Cut-Out

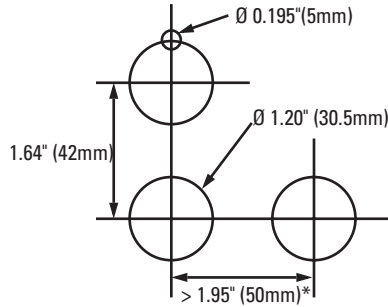

1. *Jumbo Mushroom < 2.61" (66mm)
2. Minimum mounting centers are applicable to switches with one stack of contact blocks. When mounting two stacks of contact blocks, minimum centers should allow for access to wiring.
3. The Ø 0.195" (Ø 5mm) recess is necessary when either the nameplate or anti-rotation ring is used.

Accessory Dimensions

OL-KL1 Lock-Out Adaptor

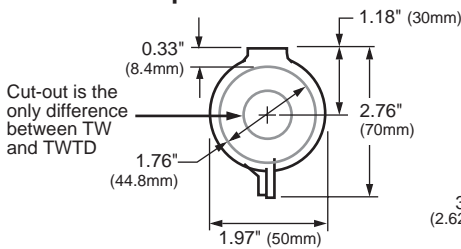

Cut-out is the only difference between TW and TWTD

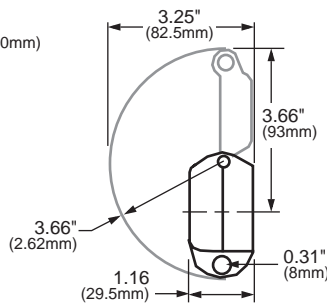

OC-31 Pushbutton Clear Boot

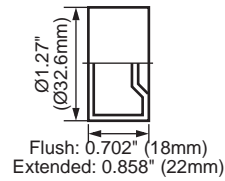

OGL-31 Anti-Rotation Ring

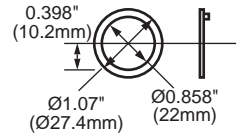

OB-31 Mounting Hole Rubber Plug

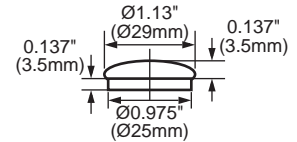

Finger-Safe Cover

N-VL2

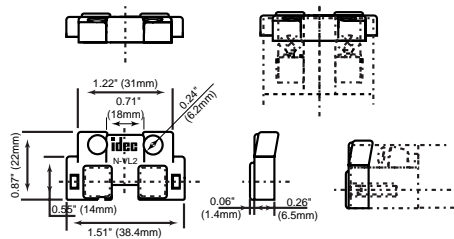

N-VL3

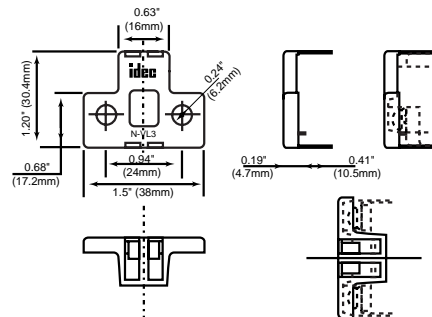

N-VL4

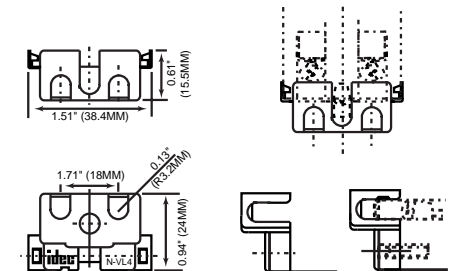

APD-PVL

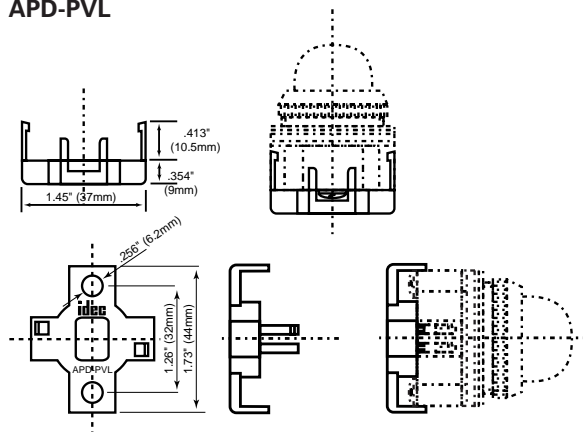

Instructions — TWTD Series

A4

Switches & Pilot Devices

Adjustment for Panel Thickness

Each unit is shipped with several waterproof gaskets which are 0.06" (1.5mm) and 0.12" (3mm) thick. Combine the gaskets for a dimension approximately equal to panel thickness and install between the bezel and the body of the unit.

A trim washer must be used with a thrust washer or a nameplate to prevent the control unit from rotating in the mounting hole. When using anti-rotation rings (trim washer with thrust washer or nameplate), install as shown below.

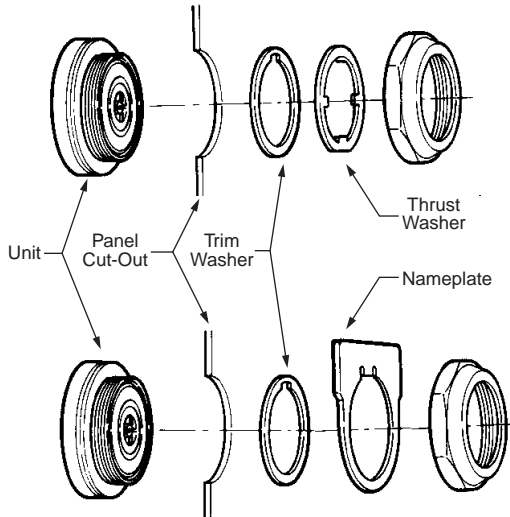

Selector Switches

The operator shaft of each unit has a recess to identify in which direction to install the handle. Align the handle with the recess. Press color insert (TW-HC1) into the Standard Operating Positions.

Standard operation positions

2-Position, 90°



3-Position, 45°

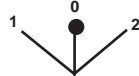

Non-Illuminated 3-Position Operators



Installation of TWTD Series Units

TWTD Pilot Lights

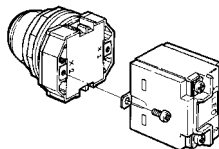

TWTD Illuminated Pushbuttons, TWTD Selector Switches (Transformer or Full Voltage)

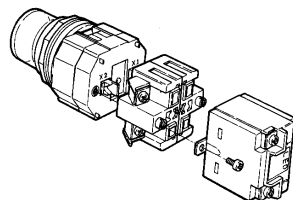

Terminal X1 = Positive
Terminal X2 = Negative

Installation of LED Illuminated Units—Transformer units are recommended for use in areas subjected to inductive noise. When using full voltage types, install a protection diode as shown below. Use diode with AC power supply to protect against reverse polarity. Use with DC power supply to protect against surges and noise.



Make sure that LED illuminated units are installed with correct polarity, as indicated at the terminals.

Application Example For Push-To-Test Pilot Light

A typical application of illuminated pushbuttons is a push-to-test pilot light which can be used to check the lamp/LED circuit.

Transformer/AC-Adapter Circuit

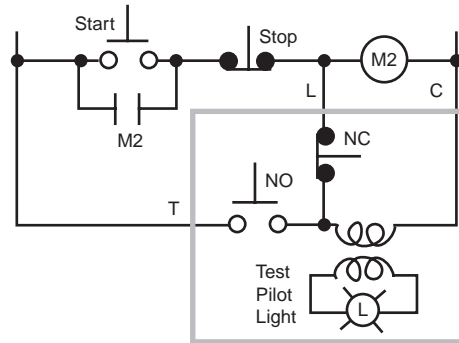

Full Voltage Circuit

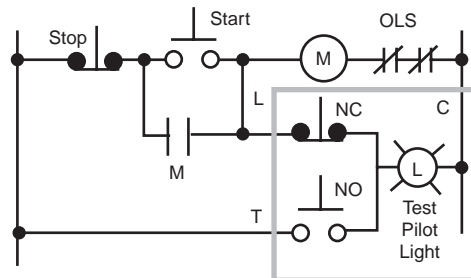

CS Series — Heavy Duty Cam Switches

Key features of the CS Series include:

- Wide variety of heavy-duty oiltight cam switches
- Operators available up to 12 positions
- Switches made with a double circuit contact block
- Contact blocks rated 600V, 10A
- Ideal for ammeter/voltmeter applications
- Built to order — not available in subcomponents
- UL listed and CSA certified
- NEMA 4, 13

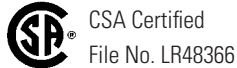

A4

Switches & Pilot Devices

Contact Ratings	Rated Thermal Current		10A				
	AC	Break Current	120V/5A	240V/3A	480V/2A	600V/1A	
	DC	Resistive	Break Current	24V/8A	110V/8A	220V/1A	440V/0.45A
		Inductive	Break Current	24V/5A	110V/1.2A	220V/0.45A	440V/0.20A
			Make Current (A)	Rated amperage x 1.1			
	Electrical Life			500,000 operations minimum (at full rated load)			
Mechanical Life			5,000,000 (at no load)				

CS Series

Operator					
Series	Appearance	Cam Angle	Position	Maximum Contacts To Be Mounted	Handle Styles
ACSNO		30°	Up to 12	1 to 10 decks; Up to 20 contacts	YB, SB, PB, FB
		45°	Up to 8		
		60°	Up to 6		
		90°	Up to 4		
		45°	2 or 3		
ACSNK		30°	Up to 12	1 to 10 decks; Up to 20 contacts	HB or standard key
		45°	Up to 8		
		60°	Up to 6		
		90°	Up to 4		
		45°	2 or 3		
UCSQO		30°	Up to 12	1 to 10 decks; Up to 20 contacts	YB, SB, PB, FB
		45°	Up to 8		
		60°	Up to 6		
		90°	Up to 4		
		45°	2 or 3		
UCSQM		45° Spring return	Only 3	1 to 3 decks; Up to 6 contacts	YB, SB, PB, FB



1. It is recommended to use spring return (SR) for a maximum of six contacts.
2. Two identical keys come with ACSNK unit. Specify "H" for handle key option.
3. For handle styles, see page A4-200.

CS Series – Heavy Duty Cam Switches

A4

Switches & Pilot Devices



Assembled Oiltight Cam Switches
ACSNO – 3 6 6 – () S B – C3013

Series

- ACSNO = Standard Cam Switch (30mm)
- ACSNK = Key Cam Switch (30mm)
- UCSQO = Cam Switch (5 hole mounting)
- UCSQM = 3 Position Spring Return Cam Switch (5 hole mounting)

Number of Levels (Decks)

1 through 10
Note: One level contains two independent contacts.*

Number of Positions

2 through 12

Angle

- 3 = 30° (12 position max)
- 4 = 45° (8 position max)
- 6 = 60° (6 position max)
- 9 = 90° (4 position max)

Contact Arrangement

1. For standard contact arrangements, use designations on pages A4-197 and A4-198.
2. For custom contact arrangements, omit contact arrangement designation and complete the blank order form on the next page.

Handle

- YB** = Knob, Small
- SB** = Lever, Small
- PB** = Lever, Large
- FB** = Knob, Large
- HB** = Handle Key (ACSNK only)
- Blank** = Standard Key (ACSNK only)

Spring Return Action

- Blank: Maintained
- RO** = Spring return from left (2, 3 or 4 position, 45° only)
- OR** = Spring return from right (2, 3 or 4 position, 45° only)
- RR** = Return from right and left (3 pos, 45° only)



1. *Contact blocks may contain two independent contacts, (a four position switch with four independent contacts only requires two contact blocks).
2. *Caution: switches with 180° or more of rotation may require separate blocks for each contact due to cam overlapping. Contact IDEC for details.
4. Key removable in every 45° position (45, 90, 180, 225, 270, 315, 360).

Contact Arrangements

Standard Arrangements

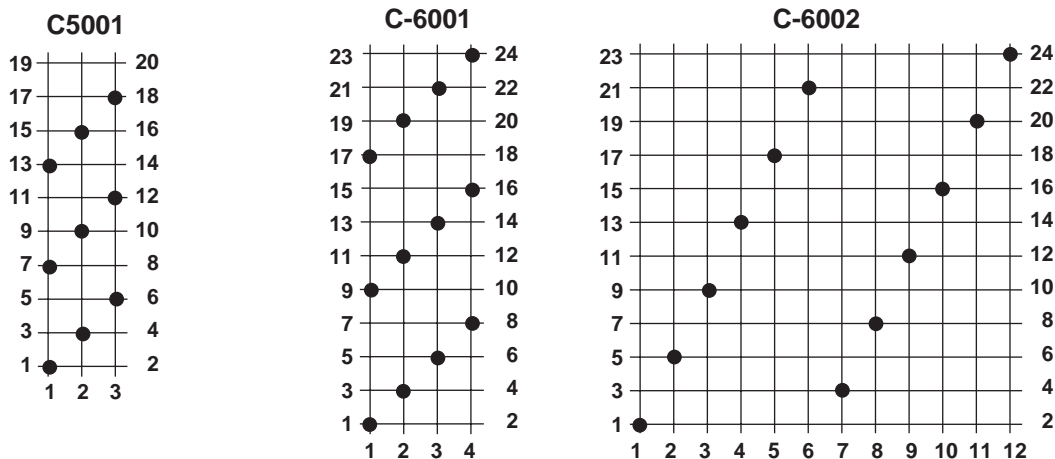
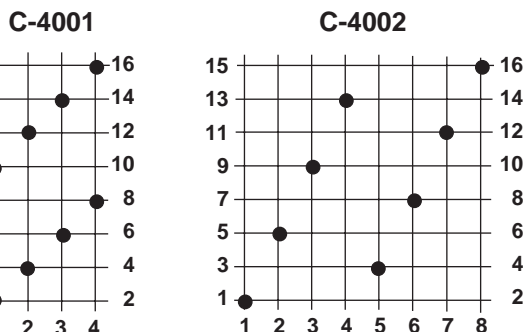
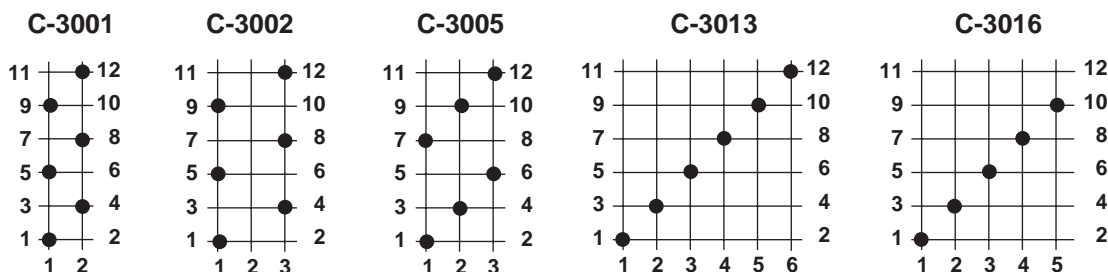
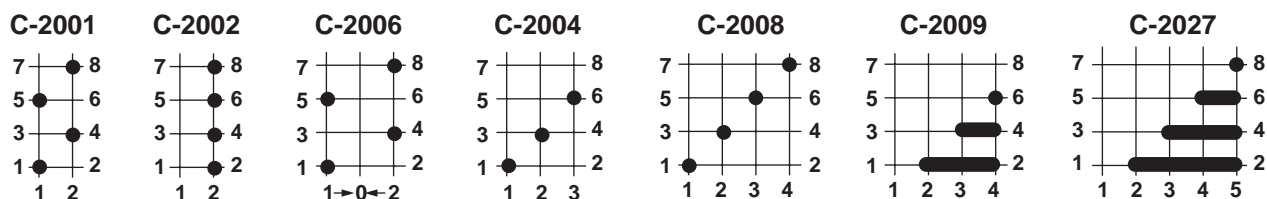
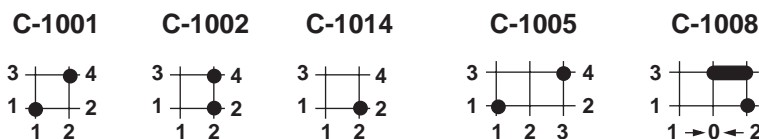
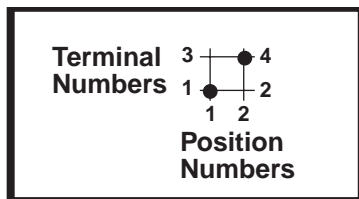

Contact Arrangements con't

Ammeter Switching

C-1012

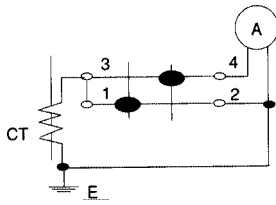

C-4007

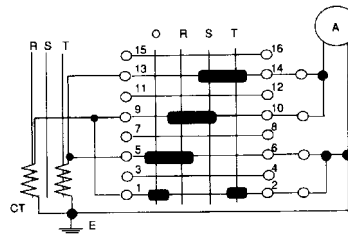

C-4003

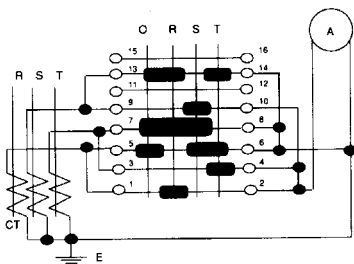

C-6003

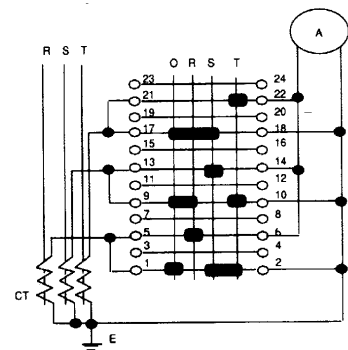

Voltmeter Switching

C-2022

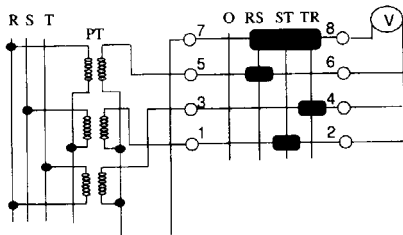

C-3008

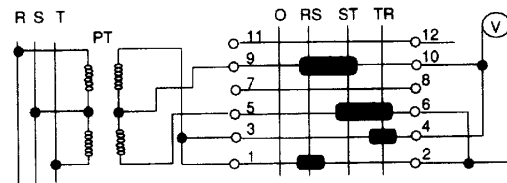

C-3009

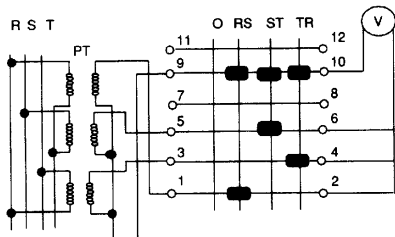

C-3007

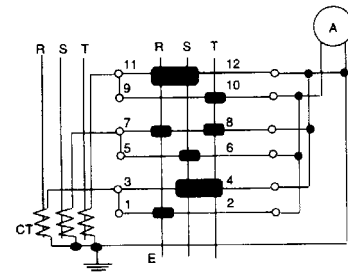

A4
Switches & Pilot Devices

Order Form (Custom Contact Arrangement)

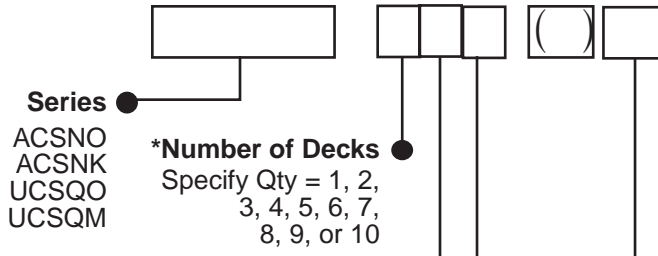

Series
 ACSNO
 ACSNK
 UCSQO
 UCSQM

***Number of Decks**
 Specify Qty = 1, 2,
 3, 4, 5, 6, 7,
 8, 9, or 10

*** Note:** One Deck can drive two independent contacts.

Number of Positions

Unit	Angle	Positions
ACSNO	30° only	9, 10, 11, 12
	30° or 45° only	7 or 8
ACSNK*	30°, 45° or 60°	5 or 6
UCSQO	30°, 45°, 60°, 90°	2, 3, or 4
	45° only	3 only

* ACSNK keys only remove at 45°.



Angle
 3 = 30°
 4 = 45°
 6 = 60°
 9 = 90°

Spring Return

Blank = Maintained
 RO = Spring return from left
 (3 or 4 position, 45° only)
 OR = Spring return from right
 (3 or 4 position, 45° only)
 RR = Return from right and left
 (3 position, 45° only)

UCSQM is available in spring-return version only.

ACSNO, UCSQO, UCSQM:
 YB = Knob, Small
 SB = Lever, Small
 PB = Lever, Large
 FB = Knob, Large

ACSNK:
 HB = Handle Key (option)
 Blank = Standard Key



For handle styles, see page A4-200.

Contact Arrangement Table

Cams	Terminal No.	Position											
		1	2	3	4	5	6	7	8	9	10	11	12
Deck 1	1 and 2												
	3 and 4												
Deck 2	5 and 6												
	7 and 8												
Deck 3	9 and 10												
	11 and 12												
Deck 4	13 and 14												
	15 and 16												
Deck 5	17 and 18												
	19 and 20												
Deck 6	21 and 22												
	23 and 24												
Deck 7	25 and 26												
	27 and 28												
Deck 8	29 and 30												
	31 and 32												
Deck 9	33 and 34												
	35 and 36												
Deck 10	37 and 38												
	39 and 40												



To specify non-standard arrangements (designation not on preceding pages), fill in this table using the following symbols.

X = Closed contact (break before make) O = Open contact ~~X~~ = Overlapping contact (remain on when switch is moved between two positions)

Specifying Nameplate (Optional)

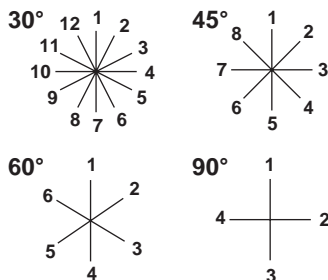

Specifying Legends

Position

- 1 _____
- 2 _____
- 3 _____
- 4 _____
- 5 _____
- 6 _____



If no engraving information is provided, a blank nameplate will be supplied.

- 7 _____
- 8 _____
- 9 _____
- 10 _____
- 11 _____
- 12 _____

Accessories — CS Series



Replacement Handles

A4

Switches & Pilot Devices



					
Part Number	CSH-YB	CSH-SB	CSH-PB	CSH-FB	CSH-H2B
Dimensions	0.79"D x 1.61"H	0.79"D x 1.97"H	1.58"D x 1.97"H	1.58"D x Ø 1.97"	0.95"D x 2.28"H
Applicable Models	ACSNO, UCSQO, UCSQM				ACSNK

Replacement Nameplates

Size & Shape □ 2.52" (64mm) Black Aluminum			
Part Number	CQ	CQM	CQN
Applicable Models	UCSQO	UCSQM	ACSNO, ACSNK

-  1. Extra cost for engraving, 3/16" min. letter height. For legends with more than ten characters, consult IDEC.
2. Blank nameplates are supplied with all cam switches (they need not be ordered separately).

Wiring Clips

Part Number	Contact Block Jumpers
CJ-1 	Between cams
CJ-2 	Same cam

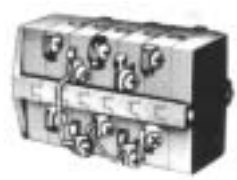

Replacement Keys

Part Number	
K301 	Pair of keys (#301)

Dimensions/Terminal Arrangements/Mounting Holes

A4

Switches & Pilot Devices

ACSNO

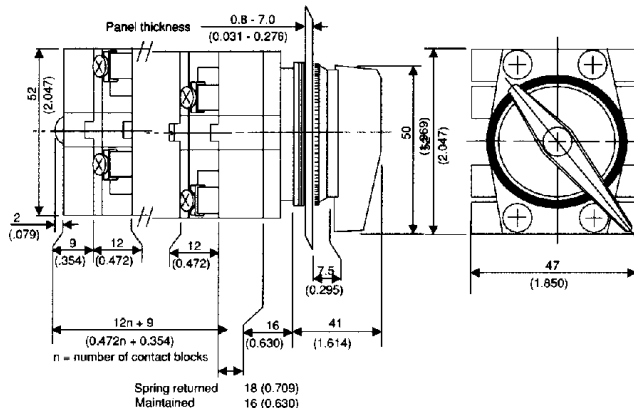

ACS NK

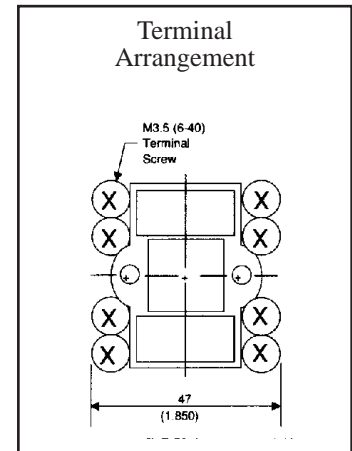
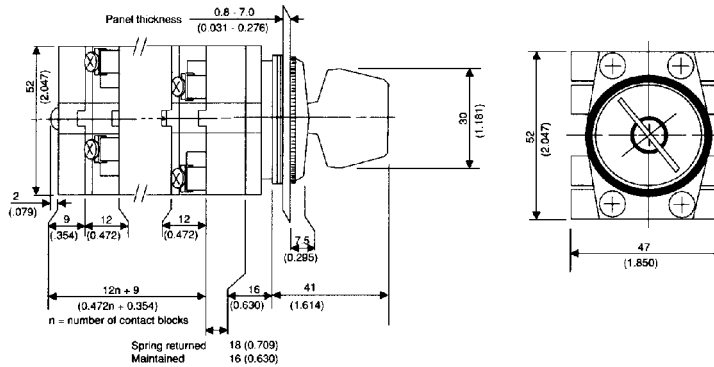

UCSQO

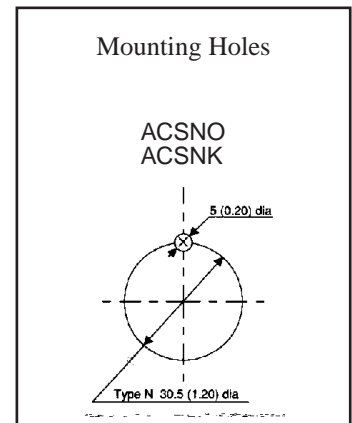
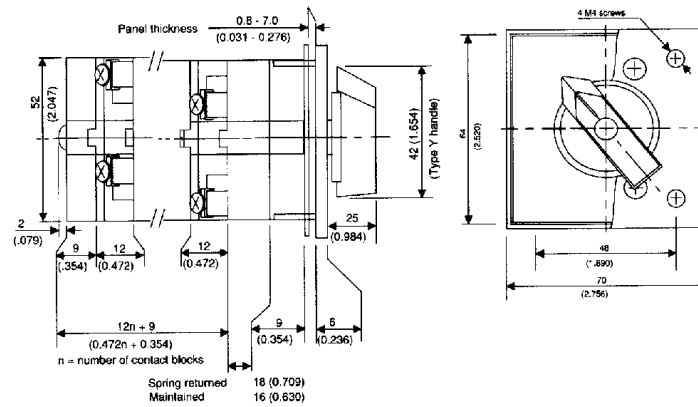

UCSQM

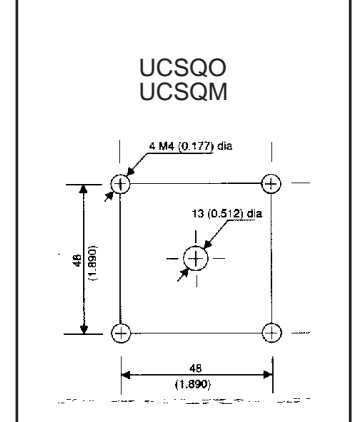
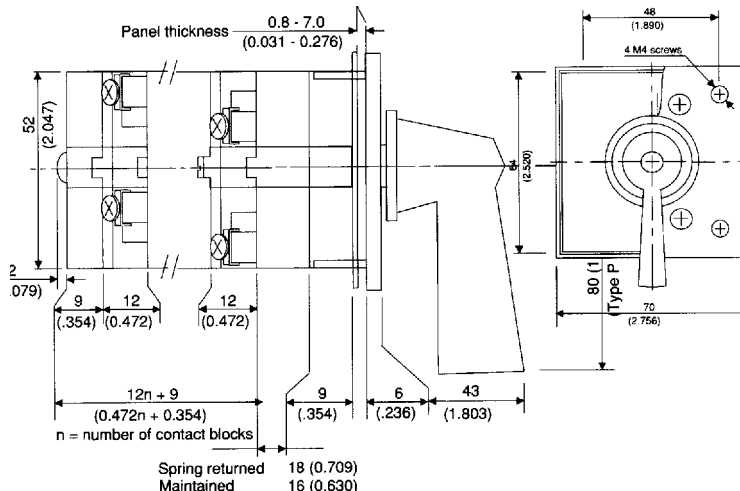

ARN Series — Mono-Lever Switches

**Mono-Lever Switches Ø 1-13/64" (30mm)
Contact Blocks Rated for 600V, 10A**

A4

Switches & Pilot Devices

Key features of the ARN Series include:

- Available in 2-, 3-, and 4-positions.
- Maintained and spring-return modes available.
- Models available with interlock mechanism to prevent inadvertent actuation.

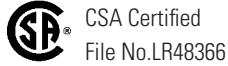

Specifications	Operating Temperature	-25° to 50°C (without freezing)	
	Insulation Resistance	100MΩ	
	Contact Rating	Rated Voltage: Current	110VDC: 3A 24V AC/DC: 10A 120VAC: 10A 240VAC: 6A 480VAC: 2A 600VAC: 1A
		Insulation Voltage	600V AC/DC
		Rated Thermal Current	10A
		Electrical Life	Over 500,000 operations

Part Numbering Guide (Assembled)

Part Numbering Guide: Assembled Mono-Levers

Example: Part Number ARN4-1012-10.00.02.11-B

ARN **4** - **1012** - **10.00.02.11**



- ① Type ② No. of Contact Blocks ③ Lever Action ④ Contact Arrangement

	Description	Code	Remarks	
① Type	Standard Lever	ARN	Interlocking lever prevents inadvertent operation.	
	Short Lever	ARNS		
	Interlocking Lever	ARNL		
② No. of Contact Blocks	—	1 2 3 4	Each contact block contains two independent contacts.	
	③ Lever Action	Blocked		0
		Maintained		1
		Spring Return		2
④ Contact Arrangement	No contacts	00	Specify in this order: Up.Right.Down.Left	
	1 NO contact	10		
	1 NC contact	01		
	1 NO and 1 NC contact	11		
	2 NO contacts	20		

Mono-Lever Switches (Sub-Assembled)



Part Numbers: Standard Mono-Lever Operators

Operator Type	Lever Operation Mode	Part Number
	2-Position manual return 3-Position manual return 4-Position manual return	ARN0-1010-B ARN0-1110-B ARN0-1111-B
	2-Position spring return 3-Position spring return 4-Position spring return	ARN0-2020-B ARN0-2220-B ARN0-2222-B
	2-Position manual return 3-Position manual return 4-Position manual return	ARNS0-1010-B ARNS0-1110-B ARNS0-1111-B
	2-Position spring return 3-Position spring return 4-Position spring return	ARNS0-2020-B ARNS0-2220-B ARNS0-2222-B
	2-Position manual return 3-Position manual return 4-Position manual return	ARNL0-1010-B ARNL0-1110-B ARNL0-1111-B
	2-Position spring return 3-Position spring return 4-Position spring return	ARNL0-2020-B ARNL0-2220-B ARNL0-2222-B



Part Numbers: Contact Blocks

Contact Arrangement	Part Number
2NO contacts	BR-1E
1NO & 1NC contact	BR-2E
2NC contacts	BR-3E
1NO early make contact	BR-1EM



To calculate the number of contact blocks required, add the number of NO and NC contacts on each pair of adjoining positions (up + right, right + down, down + left, and left + up). The largest of the four sums is the number of contact blocks required. Up to four contact blocks can be mounted.

Replacement Parts

Item	Part Number
	ARN0, ARNS0 (standard & short lever) ARN-BL
	ARNL0 (Interlocking) ARNL-BL (comes in 2 pieces)
	All Models Knob (ball) ARNB-B

Dimensions — ARN Series

A4

Switches & Pilot Devices

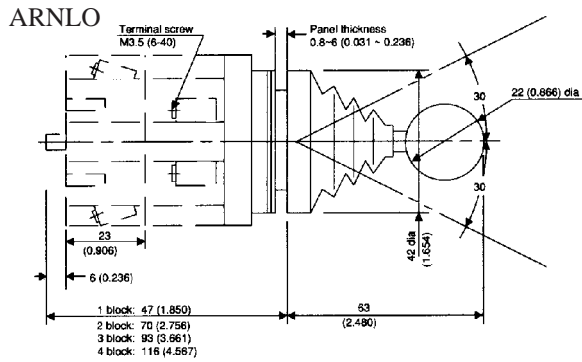
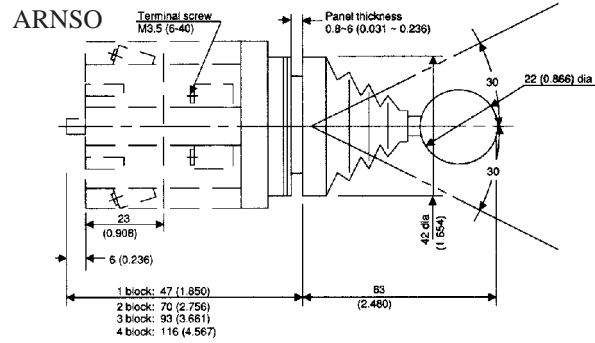
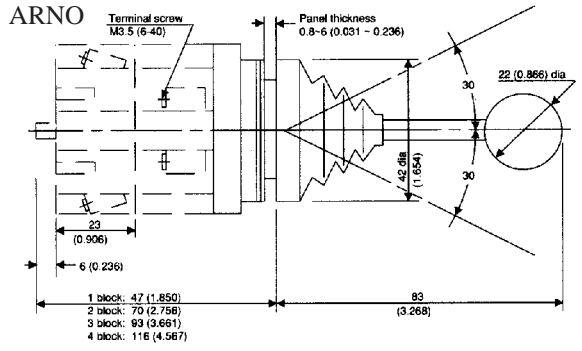

Mounting Hole

ARNO
ARNSO
ARNLO

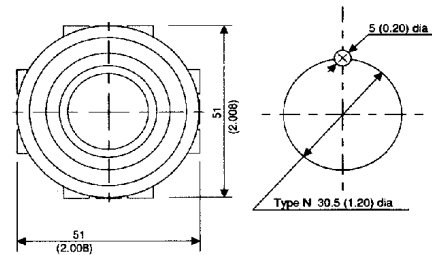

A8 Series — Miniature Switches and Pilot Devices: 8mm

Key features of the 21/64" (8mm) A8 series Switches and Pilot Devices include:

- 21/64" (8mm) round mounting hole
- Compact Design Saves Space
- Bright and Vivid Illumination
- Choice of Shapes and Functions
- Gold Clad Silver Contacts for reliable low level switching
- Snap action contacts
- IP40 (Dustproof) Construction

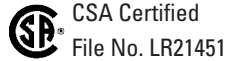

A5



Switches & Pilot Devices

Specifications	LED Lamp Life	50,000 hours approximately (reduced to half of original intensity)		
	Contact Configuration	SPDT		
	Maximum Voltage	250V AC/DC		
	Thermal Current	3A		
	Contact Material	Gold-clad Silver		
	Terminal Style	Solder Tab Terminal		
	Operating Temperature	-25° to +55°C (no freezing)		
	Operating Humidity	45 to 85% RH		
	Contact Resistance	50mΩ maximum (initial value)		
	Insulation Resistance	100MΩ minimum (500V DC megger)		
	Vibration Resistance	5 to 55Hz, 0.75mm amplitude		
	Shock Resistance	Damage limits: 500m/sec ² (approx. 50G) Operating extremes: 200m/sec ² (approx. 20G)		
	Electrical Life	100,000 operations minimum		
	Mechanical Life	Maintained: 100,000 (1200 operations/hour) Momentary: 200,000 minimum		
Contact Ratings	Degree of Protection	IP40 Enclosed/Dustproof		
	Soldering Temperature	20W/5 seconds or 260°C/3 seconds		
	Dielectric Strength	Switch Unit: 2,000V AC, 1 min. between live/dead part and terminals of different poles; 1,000V AC, 1 minute between terminals of the same pole; 1,500V AC, 1 minute between contact and lamp terminals. Illumination Unit: 2,000V AC, 1 min. between live part/ground		
	Operating Voltage	24V	120V	240V
	AC 50/60Hz	Resistive	—	1.0A
	Inductive	—	0.7A	0.5A
DC	Resistive	1.0A	0.2A	—
	Inductive	0.7A	0.1A	—



1. AC Inductive Load, PF = 0.6 – 0.7; DC Inductive Load, L/R = 7.
2. Minimum applicable load (reference value) is 5V AC/DC 3mA (applicable range is subject to the operating conditions and load).

AB8 Non-Illuminated Pushbuttons (Assembled)
Part Numbers: Non-Illuminated Pushbuttons

Style	Contact	Part Numbers	
		Momentary	Maintained
Round 	SPDT	AB8M-M1-①	AB8M-A1-①
Square 	SPDT	AB8Q-M1-①	AB8Q-A1-①
Rectangular 	SPDT	AB8H-M1-①	AB8H-A1-①





1. In place of ①, specify button color code from the table below.
2. For accessories, see page A5-208.
3. For dimensions, see page A5-209.

① Button Color Code

Color	Code
Black	B
Green	G
Red	R
Blue	S
White	W
Yellow	Y

AL8 Illuminated Pushbuttons and Pilot Lights (Assembled)

Part Numbers: LED Illuminated Pushbuttons and Pilot Lights

Style	Contact	Pushbutton Part Number		Pilot Light Part Number
		Momentary	Maintained	
 Round	SPDT	AL8M-M11-②	AL8M-A11-②	AL8M-P1-②
 Square	SPDT	AL8Q-M11-②	AL8Q-A11-②	AL8Q-P1-②
 Rectangular	SPDT	AL8H-M11-②	AL8H-A11-②	AL8H-P1-②

② Lens/LED Color Code

Color	Code
Amber	A
Green	G
Red	R
White	W
Yellow	Y



- In place of ②, specify lens color code from table on the right.
- A replaceable LED lamp is included with the operator.
- Because the LED lamp does not contain an internal current limiting resistor, an external resistor must be added. For recommended values, see table below.
- For accessories, see page A5-208.
- For dimensions, see page A5-209.

Part Numbers: Replacement LEDs

Lens Color	LED Lamp	Part Number
Amber	Amber	LAD-SA
Green	Green	LAD-SG
Red	Red	LAD-SR
White	Yellow*	LAD-SY
Yellow	Yellow	LAD-SY



* White units use a white lens and a yellow LED.

LED Voltage and Recommended Current Limiting Resistor

Voltage	External Resistor
5V DC	150Ω, 1/2W
6V DC	200Ω, 1/2W
12V DC	510Ω, 1W
24V DC	1.1kΩ, 1W

LED Lamp Ratings

LED Specifications	LED Lamp	Forward Current I _f	Forward Voltage (Nominal) V _f	Reverse Voltage V _r	Operating Voltage & External Current Limiting Resistor (Recommended Value)
	Amber	20mA	2.2V	4V	5V DC: 150Ω, 1/2w
	Green	20mA	2.1V	4V	6V DC: 200Ω, 1/2w
	Red	20mA	1.7V	4V	12V DC: 510Ω, 3/4w
	Yellow	20mA	2.2V	4V	24V DC: 1.1kΩ, 3/4w



When LED lamps are used at voltages other than those stated above, external resistor value, R, is determined by the following formula:

$$R = (\text{Operating Voltage} - V_f) / I_f$$

Accessories — A8 Series: 21/64" (8mm)

A5 Switches & Pilot Devices

Appearance	Description	Used With	Part Number	
 Locking Ring Wrench	Made of metal. Used for tightening plastic locking ring during installation. Tightening torque should not exceed 3kgf-cm	All units	MT-004	
 Lens Removal Tool	Made of metal. Used for removing lens or button from the housing	Illuminated pushbuttons and pilot lights	MT-101	
 Lamp Holder Tool	Made of rubber. Used for removing and replacing LED lamps in illuminated units	Illuminated pushbuttons and pilot lights	OR-66	
 Switch Guard	Used to avoid operating the pushbutton inadvertently. Cover flips open 90°. Provides IP40 protection	Round & square units	AL-K8	
		Rectangular units	AL-KH8	
 Terminal Cover	Made of translucent nylon. Fits over and shields the terminals	All units	AL-V8	
 Adaptor Socket	Plug-on adaptor with solder terminals, allows easy control unit replacement.	All units	AL-C8	
	Plug-on adaptor with PCB terminals, allows easy control unit replacement.		AL-C8V	
 Mounting Hole Plug	Made of rubber. Fills unused mounting holes to provide IP65 protection	Extra panel cutouts	AL-B8	
 Replacements LEDs	LED lamp is included in every illuminated control unit. Replacement lamp is ordered separately. External current limiting resistor required.	Illuminated units and pilot lights	LAD-SR (red)	
			LAD-SG (green)	
			LAD-SA (amber)	
			LAD-SY (yellow)	
 Replacement Engraving Inserts		Illuminated pushbuttons & pilot lights	Round	AL8M-W
			Square	AL8Q-W
			Rectangular	AL8H-W
 Replacement Lenses		Illuminated pushbuttons & pilot lights	Round	AL8M-LK1-②
			Square	AL8Q-LK1-②
			Rectangular	AL8H-LK1-②
 Replacement Buttons		Non-Illuminated buttons	Round	AB8M-BK1-①
			Square	AB8Q-BK1-①
			Rectangular	AB8H-BK1-①



- In place of ①, specify Button Color Code from the table on the right.
- In place of ②, specify Lens/LED Color Code from table on the right.

① Button Color Code

Color	Code	Color	Code
Black	B	Blue	S
Green	G	White	W
Red	R	Yellow	Y

② Lens/LED Color Code

Color	Code
Amber	A
Green	G
Red	R
White	W
Yellow	Y

Dimensions — A8 Series: 21/64" (8mm)

AΔ8 Pushbuttons

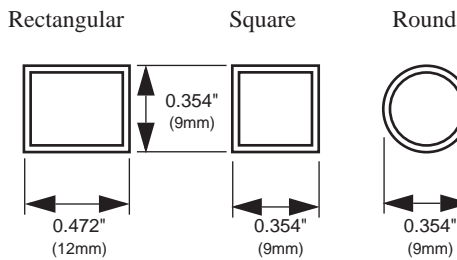
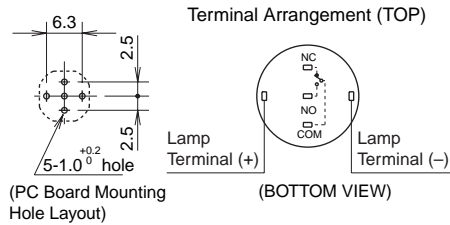
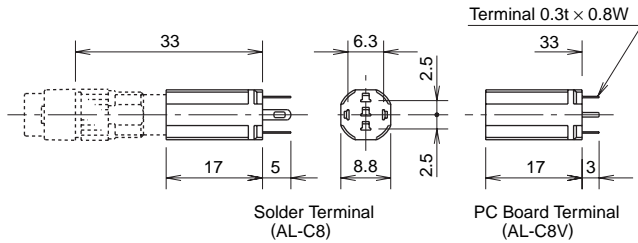

Terminal Arrangement (Bottom View)

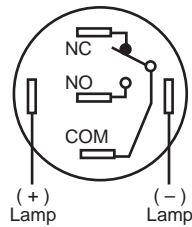

Terminal Cover

AL-V8, ø 21/64" (8mm)

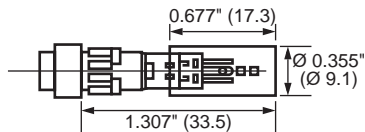

Panel Cut-Out (not drawn to scale)

Rectangular ø 0.315" (+0.008, -0)
ø 8mm (+0.2, -0)

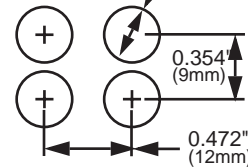

Round/Square ø 0.315" (+0.008, -0)
ø 8mm (+0.2, -0)

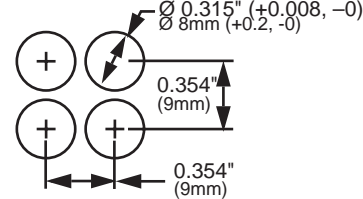

Switch Guard, ø 21/64" (8mm)

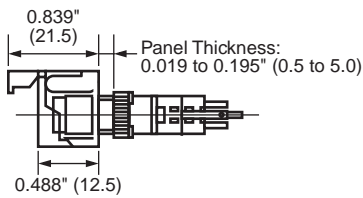

AL-K8, ø 21/64" (8mm)
Round and Square

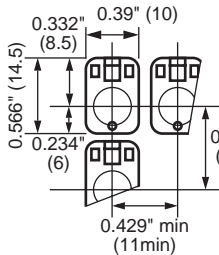

AL-KH8, ø 21/64" (8mm)
Rectangular

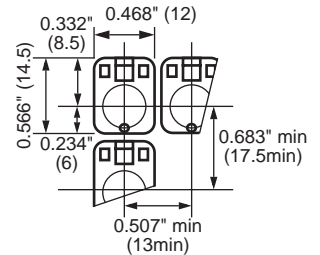

Terminal Sockets

AL-C8, ø 21/64" (8mm), Solder

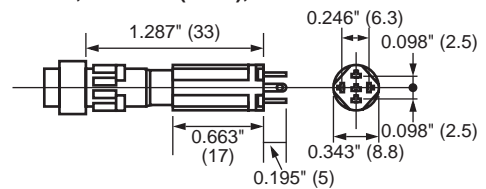

AL-C8V, ø 21/64" (8mm), PCB

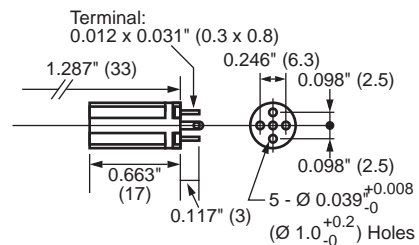

PC Board Drilling Layout
Bottom View

AP Series — Miniature Pilot Lights

Miniature Pilot Lights with Super Bright LEDs

Key features of AP series include:

- Long service life, low maintenance
- Space saving miniature style
- Dome or flat lens models
- Built-in current-limiting resistor and reverse polarity protection diode
- Five illumination colors: red, green, amber, yellow, and white
- AC adaptor (120V AC and 240V AC) and DC-DC Converter (110V DC) options on 12mm and 16mm units

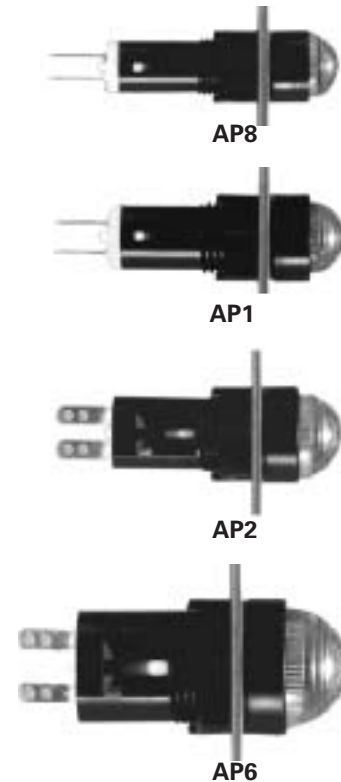
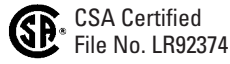

Switches & Pilot Devices

A5

Specifications	Lamp	Built-in LED with current limiting resistor
	Operational Voltage	6, 12, 24VDC (full voltage), 110/120, 220/240VAC, (transformer) 110VDC (with converter)
	Current Ratings	AP8: 6VDC/18mA, 12VDC/18mA, 24VDC/12mA AP1: 6VDC/18mA, 12VDC/18mA, 24VDC/12mA AP2: 6VDC/33mA, 12VDC/22mA, 24VDC/11mA AP6: 6VDC/33mA, 12VDC/22mA, 24VDC/11mA
	Operating Temp.	-20°C to +55°C
	Operating Humidity	45 to 85% RH
	Insul. Resistance	100MΩ min. (500V DC megger) Between live and dead parts
	Rev. Withstand Voltage	AP2/AP6: 100V AP1/AP8: 200V
	Solder Terminal	Soldering 260°C maximum (5 sec.)
	Degree of Protection	AP8: IP40 (dustproof) Other Series: IP65 (oiltight)





Optional Adaptors/Converters		AC Adaptor	DC-DC Converter
	Applicable Units	AP2 & AP6 (with 6V LED only)	
	Operating Voltage	110/120VAC 50/60 Hz 220/240VAC 50/60 Hz	110V DC (90 to 140V DC)
	Power Consumption	1.6 VA maximum	1W maximum
	Insulation Voltage	250 V AC	140V DC
	Insulation Resistance	10MΩ min. (500V DC megger) Between live and dead parts	
	Dielectric Strength	2,000V AC, 1 minute Between live/dead parts 2,000V AC, 1 minute Between terminals	2,000V AC, 1 minute Between live/dead parts 1,500V AC, 1 minute Between terminals



Available as one piece only (replacement LEDs are not available).

Miniature Pilot Lights (Assembled)

Part Numbers: AP Miniature Pilot Lights

Appearance	Lens Style	Operating Voltage	Part Numbers
AP8 Series - ø 8mm 	Dome	6V DC +/- 5% 12V DC +/- 10% 24V DC +/- 10%	AP8M266-② AP8M211-② AP8M222-②
	Flat	6V DC +/- 5% 12V DC +/- 10% 24V DC +/- 10%	AP8M166-② AP8M111-② AP8M122-②
AP1 Series - ø 10mm 	Dome	6V DC +/- 5% 12V DC +/- 10% 24V DC +/- 10%	AP1M266-② AP1M211-② AP1M222-②
	Flat	6V DC +/- 5% 12V DC +/- 10% 24V DC +/- 10%	AP1M166-② AP1M111-② AP1M122-②
AP2 Series - ø 12mm 	Dome	6V DC +/- 5% 12V DC +/- 10% 24V DC +/- 10%	AP2M266-② AP2M211-② AP2M222-②
	Flat	6V DC +/- 5% 12V DC +/- 10% 24V DC +/- 10%	AP2M166-② AP2M111-② AP2M122-②
AP6 Series - ø 16mm 	Dome	6V DC +/- 5% 12V DC +/- 10% 24V DC +/- 10%	AP6M266-② AP6M211-② AP6M222-②
	Flat	6V DC +/- 5% 12V DC +/- 10% 24V DC +/- 10%	AP6M166-② AP6M111-② AP6M122-②

② Color Code

Color	Code
Amber	A
Green	G
Red	R
White	W
Yellow	Y



1. In place of ②, specify the color code.
2. For dimensions, see page A5-212
3. For accessories, see page A5-212.

Part Numbers: Optional AC Adaptors and DC-DC Converters (for AP2 and AP6 only)

Appearance	Style	Voltage	Part Numbers	
			Used with AP2 Series	Used with AP6 Series
 Secondary Voltage = 6V	AC Adaptor	110/120V AC 220/240V AC	AP2-0126D AP2-0246D	AP6-0126D AP6-0246D
	DC-DC Converter	110V DC (90-140V DC)	AP2-016DD	AP6-016DD







1. Optional AC adaptors and DC-DC converters snap onto the back of AP2 or AP6 pilot lights.
2. AC Adaptors and DC-DC Converters step down to 6V.
3. For dimensions, see page A5-213.

Accessories — AP Series

A5

Switches & Pilot Devices

Appearance	Description	Used With	Part Number
Locking Ring Wrench 	Made of metal. Used for tightening plastic locking ring during installation. Tightening torque should not exceed 3kgf-cm	Ø 16mm units	MT-001
		Ø 12mm units	MT-002
		Ø 10mm units	MT-003
		Ø 8mm units	MT-004
Mounting Hole Plug 	Made of rubber. Fills unused mounting holes to provide IP65 protection	Unused 8mm panel cutouts	AL-B8
		Unused 10mm panel cutouts	AL-B1
		Unused 12mm panel cutouts	AL-B2
		Unused 16mm panel cutouts	AL-B6
Transformer Removal Tool		AP2 & AP6 snap on transformer & DC-DC converter	MT-100
Replacement Lenses 	Lenses (included with all units).	AP1M Flat	AP1M-L1-②
		AP1M Dome	AP1M-L2-②
		AP2M Flat	AP2M-L1-②
		AP2M Dome	AP2M-L2-②
		AP6M Flat	AP6M-L1-②
		AP6M Dome	AP6M-L2-②
Replacement Engraving Inserts 	Allow legends under flat lenses (included with all flat lens models).	AP1M Flat	AP1M-P1-W
		AP2M Flat	AP2M-P1-W
		AP6M Flat	AP6M-P1-W



In place of ②, specify the Lens Color Code.

② Lens Color Code

Color	Code
Amber	A
Green	G
Red	R
White	W
Yellow	Y

Dimensions — AP Series

Pilot Lights (AP Series)

Style	AP8		AP1		AP2			AP6		
	Flat	Dome	Flat	Dome	Flat	Dome	w/ Adaptor or Converter	Flat	Dome	w/ Adaptor or Converter
Panel Cut-out	Ø 0.319" (+0.0118, -0) 8.1mm (+0.3, -0)		Ø 0.398" (+0.0118, -0) 10.1mm (+0.3, -0)		Ø 0.480" (+0.0118, -0) 12.2mm (+0.3, -0)			Ø 0.638" (+0.0118, -0) 16.2mm (+0.3, -0)		
Outside Dimension	Ø 0.386" (9.8mm)		Ø 0.472" (12mm)		Ø 0.551" (14mm)		□ 0.709" (18mm)	Ø 0.709" (18mm)		□ 0.709" (18mm)

A5

Switches & Pilot Devices

