

**PLEASE CHECK WWW.MOLEX.COM FOR LATEST PART INFORMATION**

**Part Number:** [0015058108](#)  
**Status:** **Active**  
**Description:** 2.49mm (.098") Pitch Black Polyester IDT Cover, Feed-To, 10 Circuits

**Documents:**

[3D Model](#) [RoHS Certificate of Compliance \(PDF\)](#)  
[Drawing \(PDF\)](#)

**General**

Product Family	Accessories
Series	<a href="#">7841</a>
Component Type	Cover
Product Name	IDT (Insulation Displacement)

**Physical**

Circuits (Loaded)	10
Color - Resin	Black
Lock to Mating Part	No
Material - Resin	Polyester
Packaging Type	Bag

**Material Info**

Old Part Number	7841-B10B
-----------------	-----------

**Reference - Drawing Numbers**

Sales Drawing	SD-7841-****
---------------	--------------

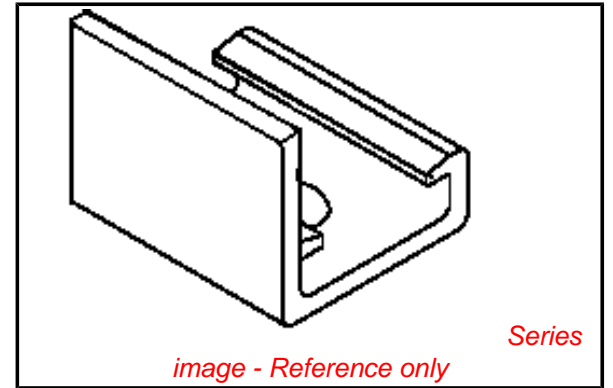

**EU RoHS**

**ELV and RoHS  
Compliant**

**REACH SVHC**

Not Reviewed

**Low-Halogen Status**

**Not Reviewed**

**China RoHS**



**Need more information on product  
environmental compliance?**

Email [productcompliance@molex.com](mailto:productcompliance@molex.com)  
 For a multiple part number RoHS Certificate of  
 Compliance, [click here](#)

Please visit the [Contact Us](#) section for any  
 non-product compliance questions.

**Search Parts in this Series**

7841Series