

# 120×120×25 mm

**San Ace 120**      Only standard fans (without sensors) have acquired CSA certification.



## General Specifications

- Material ..... Frame: Aluminum, Impeller: Plastic (Flammability: UL 94V-1)
- Expected life ..... See the table below. (L10 life: 90% survival rate for continuous operation in free air at 60°C, rated voltage)
- Motor structure ..... Shaded coil motor
- Motor protection function ..... Locked rotor burnout protection, Reverse polarity protection  
For details, please refer to p. 529.
- Dielectric strength ..... 50/60 Hz, 1500 VAC, for 1 minute (between input terminal and frame)
- Dielectric strength (with sensor) ..... Between AC input and DC input (Sensor output): 50/60 Hz 1000 VAC 1 minute  
Between AC input and G: 50/60 Hz 1500 VAC 1 minute  
Between G and DC input (Sensor output): 50/60 Hz 1000 VAC 1 minute
- Insulation resistance ..... 10 MΩ or more with a 500 VDC megger
- Sound pressure level (SPL) ..... At 1 m away from the air inlet
- Operating voltage range ..... Voltage of each model ±10%
- Storage temperature ..... -30 to +70°C (Non-condensing)
- Sensor-Purpose lead wire ..... ⊕Brown ⊖Black (Sensor) Yellow
- Mass ..... 370 g/390 g (with Sensor)

## Specifications

### Standard

Model no.	Rated voltage [V]	Frequency [Hz]	Input [W]	Current [A]	Locked rotor current [A]	Rated speed [min <sup>-1</sup> ]	Max. airflow [m <sup>3</sup> /min] [CFM]	Max. static pressure [Pa] [inchH <sub>2</sub> O]	SPL [dB (A)]	Operating temperature [°C]	Expected life [h]	
<b>109S085</b>	100	50/60	13.5/12	0.16/0.14	0.19/0.17	2500/2900	1.95/2.3 68.9/81.3	48 /51.9 0.193/0.216	38/41	-30 to +60	25000/60°C	
<b>109S084</b>	115			0.14/0.12	0.16/0.15							
<b>109S088</b>	200			0.08/0.07	0.1 /0.09							
<b>109S087</b>	230			0.07/0.06	0.08/0.07							
<b>109S081</b>	100		9.5/8.5	12/10	0.11	0.11/0.1	2200/2350	1.7 /1.8 60.1/63.6	29.4/26.5 0.118/0.106			34/35
<b>109S083</b>	115				0.1	0.1 /0.09						
<b>109S082</b>	200				0.07	0.07/0.06						
<b>109S089</b>	230				0.06	0.06/0.05						
<b>109S086*</b>	100			0.14/0.12	0.15/0.13	1400/1600	1.1 /1.25 38.9/44.2	14.7/18.6 0.059/0.075	24/27			

\*These are low-speed models.

### with Sensor

For sensor specifications, please refer to p. 531. Sensor specification differs depending on the fan's speed specification.

For a 5 V sensor power supply (ITEM-20), please append "-20" to the end of model number. E.g. 109S485-20

For a 12 V sensor power supply (ITEM-30), please append "-30" to the end of model number. E.g. 109S485-30

Model no.	Rated voltage [V]	Frequency [Hz]	Input [W]	Current [A]	Locked rotor current [A]	Rated speed [min <sup>-1</sup> ]	Max. airflow [m <sup>3</sup> /min] [CFM]	Max. static pressure [Pa] [inchH <sub>2</sub> O]	SPL [dB (A)]	Operating temperature [°C]	Expected life [h]
<b>109S485</b>	100	50/60	13.5/12	0.16/0.14	0.19/0.17	2500/2900	1.95/2.3 68.9/81.3	48 /51.9 0.193/0.216	38/41	-10 to +60	25000/60°C
<b>109S484</b>	115			0.14/0.12	0.16/0.15						
<b>109S488</b>	200			0.08/0.07	0.1 /0.09						
<b>109S487</b>	230			0.07/0.06	0.08/0.07						
<b>109S486*</b>	100		12/10	0.14/0.12	0.15/0.13	1400/1600	1.1 /1.25 38.9/44.2	14.7/18.6 0.059/0.075	24/27		

\*These are low-speed models.

## Set Models

Fan, finger guard, plug cord, screws, etc. can be purchased in one package. For details, please refer to p. 574.

Order no.	Set items					
	Fan	Voltage	Low-speed sensor	Plug cord	Finger guards	Mounting screws
ST1-109S085	109S085	100 V		489-016-L10	109-019E	M3×40 mm (4 screws)
ST1-109S084	109S084	115 V		489-016-L10	109-019E	
ST1-109S088	109S088	200 V		489-016-L10	109-019E	
ST1-109S087	109S087	230 V		489-016-L10	109-019E	
ST1-109S081	109S081	100 V		489-016-L10	109-019E	
ST1-109S083	109S083	115 V		489-016-L10	109-019E	
ST1-109S082	109S082	200 V		489-016-L10	109-019E	
ST1-109S089	109S089	230 V		489-016-L10	109-019E	
ST1-109S086	109S086			489-016-L10	109-019E	
ST1-109S485-20	109S485-20	100 V	○ (5 V)	489-016-L10	109-019E	
ST1-109S485-30	109S485-30		○ (12 V)	489-016-L10	109-019E	
ST1-109S484-20	109S484-20	115 V	○ (5 V)	489-016-L10	109-019E	
ST1-109S484-30	109S484-30		○ (12 V)	489-016-L10	109-019E	
ST1-109S488-20	109S488-20	200 V	○ (5 V)	489-016-L10	109-019E	
ST1-109S488-30	109S488-30		○ (12 V)	489-016-L10	109-019E	
ST1-109S487-20	109S487-20	230 V	○ (5 V)	489-016-L10	109-019E	
ST1-109S487-30	109S487-30		○ (12 V)	489-016-L10	109-019E	
ST1-109S486-20	109S486-20	100 V	○ (5 V)	489-016-L10	109-019E	
ST1-109S486-30	109S486-30		○ (12 V)	489-016-L10	109-019E	

## Airflow - Static Pressure Characteristics

### Standard

#### 109S085, 109S084, 109S088, 109S087

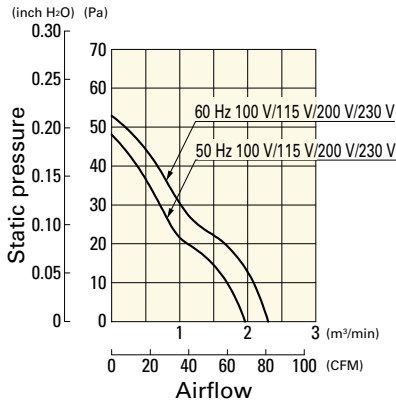

#### 109S081, 109S083, 109S082, 109S089

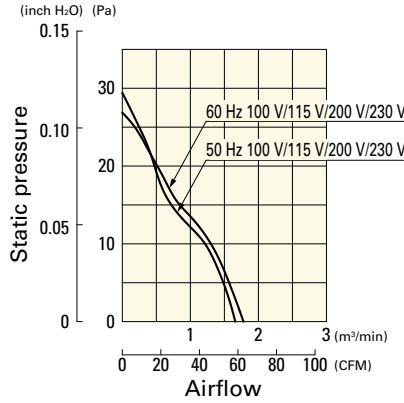

#### 109S086

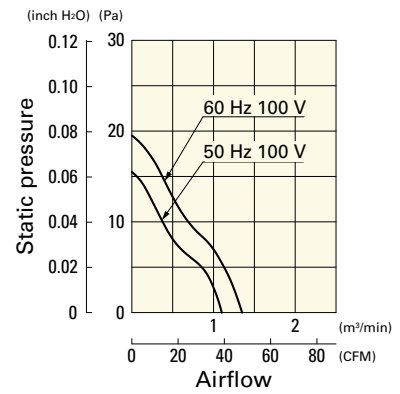

### with Sensor

#### 109S485, 109S484, 109S488, 109S487

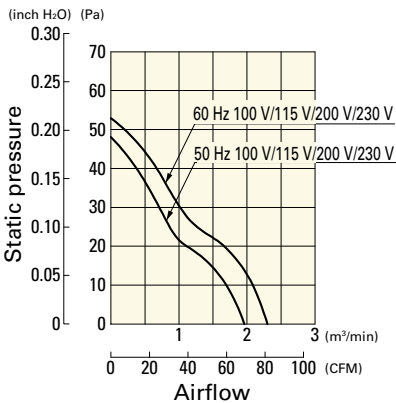

#### 109S486

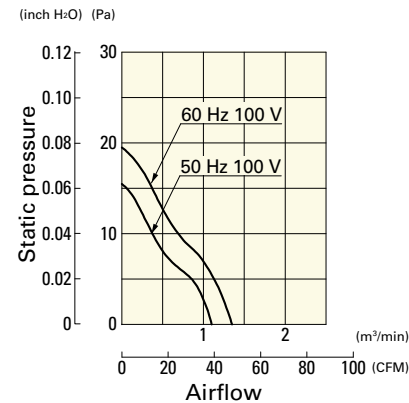

**Dimensions (unit: mm)**

**Standard**



**with Sensor** When mounting the model with a sensor, please screw-mount through both flanges as it has a sensor box.



**Reference Dimensions of Mounting Holes and Vent Opening (unit: mm)**

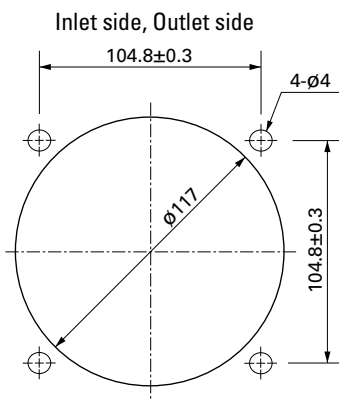

## Wiring Diagram

### Standard



### with Sensor

For fan power supply

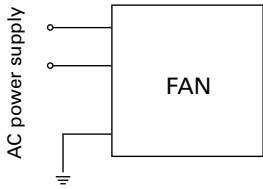

For sensor circuit  
5 V (ITEM-20)

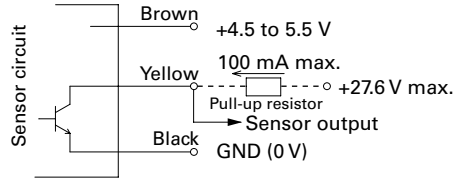

12 V (ITEM-30)

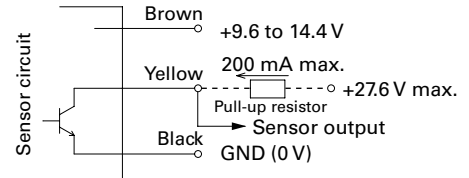

GND (Black) should be shared in case that power supply for sensor circuit (Brown) and that for sensor pull-up (Yellow) are separated.

## Options

### Finger guards

page: p. 514

Model no.: 109-019C, 109-019H, 109-019E, 109-019K

### Resin finger guards

page: p. 520

Model no.: 109-1000G

### Resin filter kits

page: p. 521

Model no.: 109-1000F13 (13PPI), 109-1000F20 (20PPI),  
109-1000F30 (30PPI), 109-1000F40 (40PPI)

### Plug cord

page: pp. 523 to 524

Model no.: 489-016-L10, 489-016-L21, 489-047-L10,  
489-047-L21