

**PLEASE CHECK WWW.MOLEX.COM FOR LATEST PART INFORMATION**

**Part Number:** [78079-0002](#)  
**Status:** **Active**  
**Overview:** [DDR3 DIMM](#)  
**Description:** 1.00mm Pitch DDR3 DIMM Socket, Vertical, Through Hole, with Beveled Metal Pins, Black Housing and Latches, 0.38µm Gold (Au) Plating, 3.18mm Soldertail, 240 Circuits, Lead-Free

**Documents:**

[3D Model](#) [Product Specification PS-78079-001 \(PDF\)](#)  
[Drawing \(PDF\)](#) [RoHS Certificate of Compliance \(PDF\)](#)

**Agency Certification**

CSA LR19980  
 UL E29179

**General**

Product Family Memory Module Sockets  
 Series [78079](#)  
 Component Type Socket  
 Electrical Model Yes  
 JEDEC Outline MO-269  
 Overview [DDR3 DIMM](#)  
 Product Name DDR3 DIMM  
 UPC 822350959117

**Physical**

Circuits (Loaded) 240  
 Circuits (maximum) 240  
 Color - Resin Black  
 Durability (mating cycles max) 25  
 Entry Angle Vertical  
 Flammability 94V-0  
 Function Key None  
 Keying to Mating Part Yes  
 Material - Metal Copper Alloy  
 Material - Plating Mating Gold  
 Material - Plating Termination Tin  
 Material - Resin High Temperature Thermoplastic  
 Net Weight 8.800/g  
 PC Tail Length 3.18mm  
 PCB Locator Yes  
 PCB Retention Yes  
 PCB Thickness - Recommended 2.36mm  
 Packaging Type Tray  
 Pitch - Mating Interface 1.00mm  
 Pitch - Termination Interface 1.00mm  
 Plating min - Mating 0.381µm  
 Plating min - Termination 2.540µm  
 Temperature Range - Operating -55°C to +85°C  
 Termination Interface: Style Through Hole

**Electrical**

Current - Maximum per Contact 1A  
 Voltage - Maximum 30V AC (RMS)/DC  
 Voltage Key Center

**Solder Process Data**

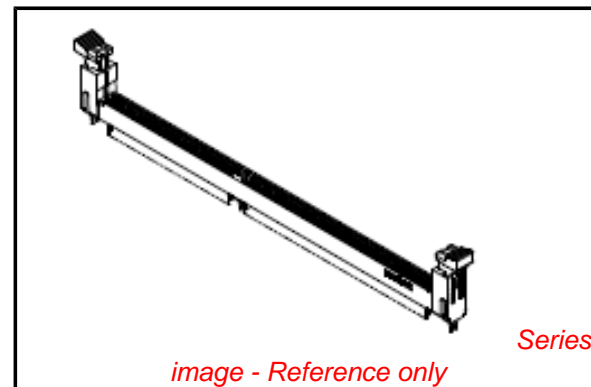

**EU RoHS**

**ELV and RoHS  
 Compliant**  
**REACH SVHC  
 Contains SVHC: No  
 Low-Halogen Status  
 Not Low-Halogen**

**China RoHS**



**Need more information on product  
 environmental compliance?**

Email [productcompliance@molex.com](mailto:productcompliance@molex.com)  
 For a multiple part number RoHS Certificate of Compliance, [click here](#)

Please visit the [Contact Us](#) section for any non-product compliance questions.

**Search Parts in this Series**

78079Series

**Mates With**

JEDEC Standard 1.27mm Modules

Duration at Max. Process Temperature (seconds)	5
Lead-free Process Capability	SMC & Wave Capable (TH only)
Max. Cycles at Max. Process Temperature	2
Process Temperature max. C	260

### **Material Info**

### **Reference - Drawing Numbers**

Electrical Model Document	EE-78079-001, EE-78079-002, EE-78079-003, EE-78079-004, EE-78079-005, EE-78079-008
Product Specification	PS-78079-001
S-Parameter Model	SP-78079-008
Sales Drawing	SD-78079-001

This document was generated on 09/08/2014

**PLEASE CHECK [WWW.MOLEX.COM](http://WWW.MOLEX.COM) FOR LATEST PART INFORMATION**