

PLEASE CHECK WWW.MOLEX.COM FOR LATEST PART INFORMATION

Part Number: [0512810894](#)
Status: **Active**
Overview: FFC-FPC (SMT)
Description: 0.50mm Pitch Easy-On FFC/FPC Connector, Surface Mount, Right Angle, Non-ZIF, Dual Contact Style, 1.20mm Mated Height, 8 Circuits, Gold (Au) Plating

Documents:

[3D Model](#) [Packaging Specification SPK-51281-001-001 \(PDF\)](#)
[Drawing \(PDF\)](#) [RoHS Certificate of Compliance \(PDF\)](#)
[Product Specification PS-51281-003-001 \(PDF\)](#)

General

Product Family FFC/FPC Connectors
Series [51281](#)
Overview [FFC-FPC \(SMT\)](#)
Product Name Easy-On
UPC 822348700080

Physical

Actuator Type Non-ZIF
Circuits (Loaded) 8
Color - Resin Natural
Contact Position Dual
Durability (mating cycles max) 20
Mated Height 1.20mm
Material - Metal Phosphor Bronze
Material - Plating Mating Gold
Material - Plating Termination Tin
Net Weight 61.024/mg
Number of Rows 1
Orientation Right Angle
PCB Locator No
PCB Mounting Surface Mount
PCB Retention Yes
Packaging Type Embossed Tape on Reel
Pitch - Mating Interface 0.50mm
Plating min - Mating 0.102µm
Plating min - Termination 1.016µm
Polarized to PCB Yes
Stackable No
Surface Mount Compatible (SMC) N/A
Temperature Range - Operating -20°C to +85°C
Wire/Cable Type FFC/FPC

Electrical

Current - Maximum per Contact 0.5A
Voltage - Maximum 50V

Material Info

Reference - Drawing Numbers

Packaging Specification SPK-51281-001-001
Product Specification PS-51281-003-001
Sales Drawing SD-51281-011, SD-51281-012

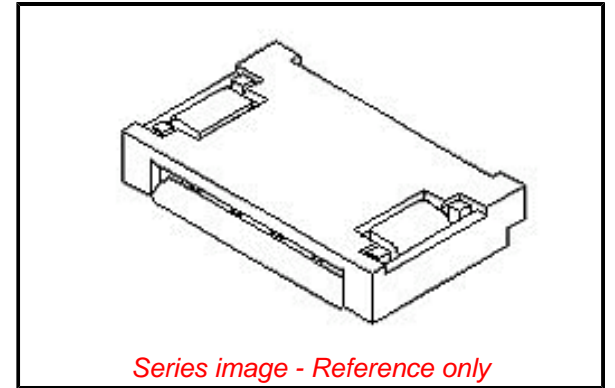

EU ELV

Not Relevant

EU RoHS

Compliant

REACH SVHC

Not Contained Per
-ED/01/2018 (15
January 2018)

Halogen-Free

Status

Low-Halogen

Need more information on product environmental compliance?

Email productcompliance@molex.com
Please visit the [Contact Us](#) section for any non-product compliance questions.

China ROHS

ELV

RoHS Phthalates

Green Image

Not Relevant

Not Contained

Search Parts in this Series

[51281 Series](#)

PLEASE CHECK WWW.MOLEX.COM FOR LATEST PART INFORMATION