

PLEASE CHECK WWW.MOLEX.COM FOR LATEST PART INFORMATION

Part Number: [0015045102](#)
Status: **Active**
Overview: [SL Modular Connectors](#)
Description: 2.54mm SL Interim Clip, 10 Circuits

Documents:

[3D Model](#) [RoHS Certificate of Compliance \(PDF\)](#)
[Drawing \(PDF\)](#)

Agency Certification

CSA LR19980
 UL E29179

General

Product Family Accessories
 Series [70004](#)
 Component Type Interim Clip
 Overview [SL Modular Connectors](#)
 Product Name SL
 UPC 800753621916

Physical

Circuits (Loaded) 10
 Circuits (maximum) 10
 Color - Resin Black
 Flammability 94V-0
 Lock to Mating Part Yes
 Material - Resin Polyester
 Net Weight 1.409/g
 Number of Rows 1
 Packaging Type Bag

Material Info

Engineering Number 70004-0009

Reference - Drawing Numbers

Sales Drawing SD-70004-0003-0057

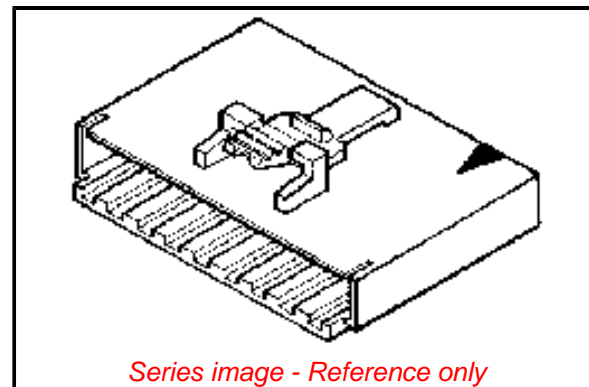

EU ELV

Not Relevant

EU RoHS

Compliant

REACH SVHC

Not Contained Per
 -ED/01/2018 (15
 January 2018)

Halogen-Free

Status

Not Low-Halogen

**Need more information on product
 environmental compliance?**

Email productcompliance@molex.com
 Please visit the [Contact Us](#) section for any
 non-product compliance questions.

China ROHS	Green Image
ELV	Not Relevant
RoHS Phthalates	Not Contained

Search Parts in this Series

[70004 Series](#)

Use With

[70066](#) SL Crimp Housing, [70058](#) SL
 Crimp Terminal, [70400](#) SL IDT Connector
 Assembly, [70430](#) SL FFC Connector