

150 Watt Industrial (VLT)

NOT RECOMMENDED FOR NEW DESIGNS



Features

- 150 W fan-cooled rating
- Smallest 150 W AC/DC power supply
- Small 5 x 3.1 x 1 inches form factor
- Dual channel output
- EN61000-3-2 Class A & Class D harmonics
- EN55022 and FCC Part15 Level B
- Cover kit accessory available

Electrical Specifications

AC Input	90-264 V, Universal	
Input Frequency	47-63 Hz	
Input Current	120 VAC: 1.8 A max.	230 VAC: 0.9 A max.
Inrush Current	120 VAC: Limited to safe value	230 VAC: Limited to safe value
Leakage Current	120 VAC: < 500 μ A	230 VAC: < 1000 μ A
Efficiency	120 VAC: 82% typical	230 VAC: 85% typical
Hold-up Time	120 VAC: 10 ms	230 VAC: 10 ms
Output Power ^{4,5}	80 to 150 W	
Line Regulation	+/-1%	
Load Regulation	V1 & V2: +/-1%, V3 & V4: +/-5%	
Transient Response	< 10%, 50% to 100% load change, 50/60 Hz, 50% duty cycle, 0.1 A/ μ s, recovery time < 5 ms	
Rise Time	< 10 ms	
Set Point Tolerance	V1 & V2: +/-1%, V3 & V4: +/-5%	
Over Current Protection	107 to 150%	
Over Voltage Protection	115 to 135%; 115 to 155% for 3.3 V	
Short Circuit Protection	Short term, autorecovery	
Switching Frequency	PFC converter: 70 kHz typical Resonant converter: 55 kHz typical	
Operating Temperature	0 to 70°C, refer derating curve	
Storage Temperature	-40 to +85°C	
Relative Humidity	95% Rh, noncondensing	
Altitude	Operating: 10,000 ft.; Nonoperating: 40,000 ft.	
MTBF	1.38m Hours, Telcordia SR332 Issue-3	
Isolation Voltage	Min. 4242 VDC between input to output	
Cooling	Convection: 80 W; 300 LFM: 150 W	
Redundancy	1+1	
Paralleling Function	No	

Model Number	Voltage	Max. Load ¹ (Convection)	Max. Load ¹ (300 LFM)	Min. Load	Ripple ²
LFVLT150-1106	V1=3.3 V	20.0 A	36.0 A	3.0 A	1.5%
LFVLT150-1100	V1=5.1 V	15.7 A	29.4 A	3.0 A	1%
LFVLT150-1101	V1=12 V	6.7 A	12.5 A	0.5 A	1%
LFVLT150-1103	V1=24 V	3.3 A	6.25 A	0.5 A	1%
LFVLT150-1104	V1=48 V	1.7 A	3.13 A	0.5 A	1%
LFVLT150-4100	V1=5.1 V, V2=3.3 V, V3=13 V, V4=-13.2 V	V1=10.0 A, V2=10.0 A, V3=1.0 A, V4=1.0 A	V1=16.0 A, V2=19.0 A, V3=1.5 A, V4=1.5 A	V1, V2=0.5 A, V3, V4=0.1 A	V2=1.5%, V1, V3, V4=1%
LFVLT150-4101	V1=5.1 V, V2=3.3 V, V3=24 V, V4=-13.2 V	V1=10.0 A, V2=10.0 A, V3=0.5 A, V4=1.0 A	V1=16.0 A, V2=19.0 A, V3=1.0 A, V4=1.0 A	V1, V2=0.5 A, V3, V4=0.1 A	V2=1.5%, V1, V3, V4=1%
LFVLT150-4102	V1=5.1 V, V2=3.3 V, V3=15 V, V4=-15 V	V1=10.0 A, V2=10.0 A, V3=1.0 A, V4=1.0 A	V1=16.0 A, V2=19.0 A, V3=1.5 A, V4=1.5 A	V1, V2=0.5 A, V3, V4=0.1 A	V2=1.5%, V1, V3, V4=1%
LFVLT80-CK metal cover kit accessory					

Connectors		
J1	Pin 1	AC NEUTRAL
	Pin 2	AC LINE
Spade Connector		EARTH
J2	Pin 1	V3
	Pin 2	V2/V1B
	Pin 3, 4	RTN
	Pin 5	V1/V1A
	Pin 6	V4

Connectors		
J3	Pin 1	V2 CURRENT SHARE/V1B CURRENT SHARE
	Pin 2	V1 CURRENT SHARE/V1A CURRENT SHARE
	Pin 3	POWER FAIL (QUAD O/P ONLY)
	Pin 4	RTN
	Pin 5	-V1/-V1A REMOTE SENSE
	Pin 6	+V1/+V1A REMOTE SENSE
	Pin 7	+V2/+V1B REMOTE SENSE
	Pin 8	-V2/-V1B REMOTE SENSE

Notes

1. Maximum current per output channel. Do not exceed total output power rating.
2. Ripple is peak to peak with 20 MHz bandwidth and 10 μ F (Tantalum capacitor) in parallel with a 0.1 μ F capacitor at rated line voltage and load ranges.
3. Power fail signal and power good signal on quad output models only.
4. Quad output models: The output section of the VLT150-4XXX is split into 2 independently regulated channels. Channel A consists of the main output V1 and auxiliary output V4. Channel B consists of the main output V2 and auxiliary output V3. The maximum output power that may be drawn per channel is 55 W with convection cooling or 75 W with fan cooling.
5. Single output models: The output section of the VLT150-1XXX is split into 2 independently regulated channels. Channel A consists of the main output V1A. Channel B consists of the main output V1B. An internal shunt resistor of value 0 Ohm connects both channels of the power supply. In an event whereby this shunt resistor is removed, the maximum output power that may be drawn per channel is 55 W with convection cooling or 75 W with fan cooling.
6. The use of remote sense function requires 300 LFM airflow.
7. Specifications are for nominal input voltage, 25°C and max. load unless otherwise stated.
8. Derate output power linearly to 80% from 90 VAC to 80 VAC input.



Mechanical Specifications

AC Input Connector (J1)	Molex: 26-60-4030 or equivalent; Mating: 09-50-3031; Pins: 08-50-0106
EARTH	Molex: 19705-4301; Mating: 190030001
DC Output Connector (J2)	Tyco: 282841-6 or equivalent
Signal Connector (J3)	Molex: 22-23-2081 or equivalent; Mating: 22-01-2087; Pins: 08-50-0113
Dimensions	5.0 x 3.14 x 1.025 inches (127.0 x 77.22 x 27.18 mm)
Weight	340 g

EMC

CE Mark	Complies with LVD Directive
Conducted Emissions	EN55022-B, CISPR22-B, FCC PART15-B, EN50082-1
Static Discharge	EN61000-4-2, Level-3
RF Field Susceptibility	EN61000-4-3, Level-3
Fast Transients/Bursts	EN61000-4-4, Level-3
Radiated Emissions	EN55022-B, CISPR22-B, FCC PART15-B, to be controlled in end system
Surge Susceptibility	EN61000-4-5, Level-3
Harmonic Current	EN61000-3-2, Class A

Safety

Safety Standard(s)	IEC60950-1 (ed.2), EN60950-1, UL60950-1 (2nd Edition), CSA C22.2 No. 60950-1 (2nd Edition), Class 1 SELV
Approval Agency	Nemko, UL, C-UL
Safety File Number(s)	Nemko: 165490 ; UL: E150565

Signal

Power Fail Signal ³	Signal goes low 1 ms advance before output goes out of regulation due to mains failure
Remote Sense ⁶	Compensation for 100 mV on V1 & V2
Power Good ³	Signal goes high after main output is within regulation band, delay is 30 ms

Derating Curve

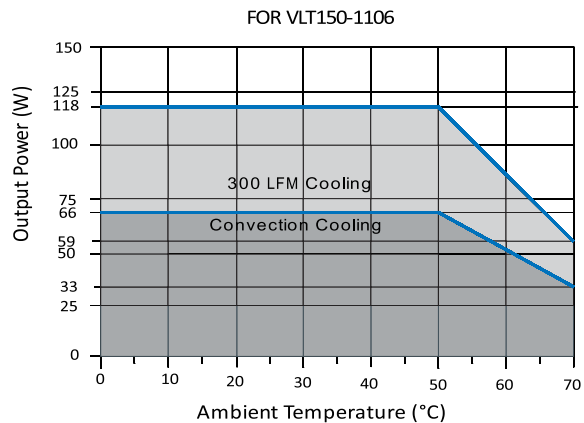
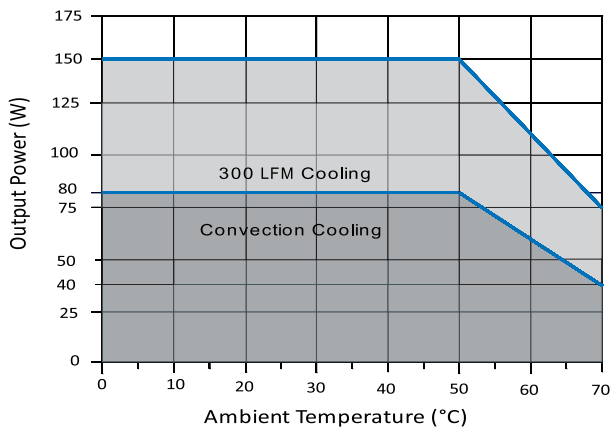

Single Output Connection

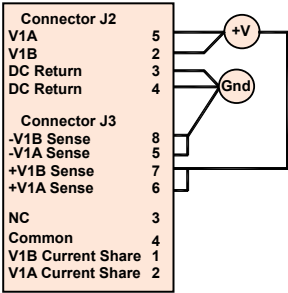

Quad Output Connection

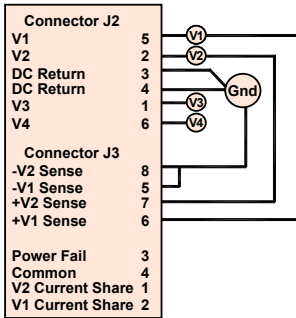

Single Output 1+1 Redundant Configuration

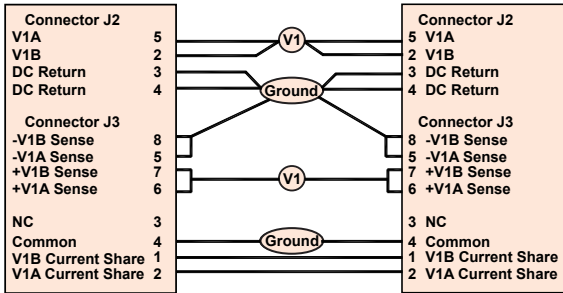

Quad Output 1+1 Redundant Configuration

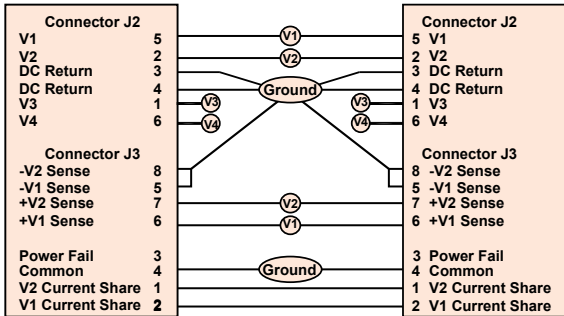

1. To connect the voltage sense pins 5, 6, 7 and 8 on connector J3 to the load, it is recommended to use 22 gauge twisted pair wire.
2. For single output units, an internal 0 Ohm resistor shunt is used to internally connect the current share pins V1B current share (J3-2) and V1A current share (J3-1).
3. Pins J3-4, Common, should be connected to ground for correct operation.
4. The Power fail signal J3-3 is a TTL active high signal. The maximum source current is 0.45 mA and the maximum sink current is 0.25 mA.

Mechanical Drawing

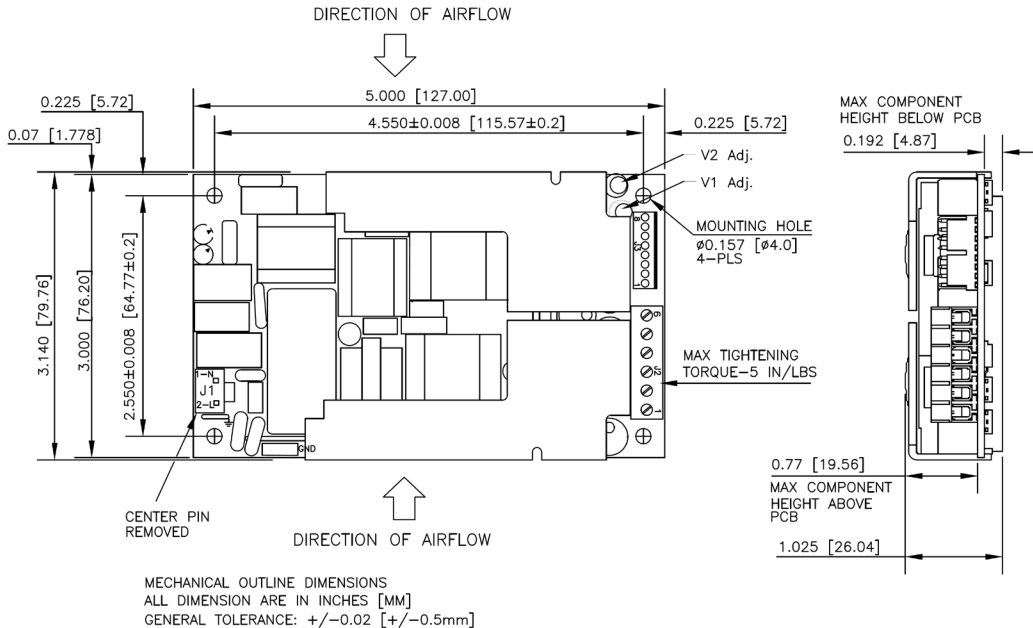

- Notes: In case the PCB is mounted in a metal enclosure, using metal hardware ensure the following
1. Stand off, used to mount PCB has OD of 5.4 mm max.
 2. Screws, used to fix PCB on stand off, have head dia of 6.0 mm max.
 3. Washer, if used, to have dia of 6.5 mm max.

