

**PLEASE CHECK WWW.MOLEX.COM FOR LATEST PART INFORMATION**

**Part Number:** [0512811894](#)  
**Status:** **Active**  
**Overview:** FFC-FPC (SMT)  
**Description:** 0.50mm Pitch Easy-On FFC/FPC Connector, Surface Mount, Right Angle, Non-ZIF, Dual Contact Style, 1.20mm Mated Height, 18 Circuits, Gold (Au) Plating

**Documents:**

[3D Model](#) [Packaging Specification SPK-51281-001-001 \(PDF\)](#)  
[Drawing \(PDF\)](#) [RoHS Certificate of Compliance \(PDF\)](#)  
[Product Specification PS-51281-003-001 \(PDF\)](#)

**General**

Product Family FFC/FPC Connectors  
 Series [51281](#)  
 Overview [FFC-FPC \(SMT\)](#)  
 Product Name Easy-On  
 UPC 822348699971

**Physical**

Actuator Type Non-ZIF  
 Circuits (Loaded) 18  
 Color - Resin Natural  
 Contact Position Dual  
 Durability (mating cycles max) 20  
 Mated Height 1.20mm  
 Material - Metal Phosphor Bronze  
 Material - Plating Mating Gold  
 Material - Plating Termination Tin  
 Net Weight 109.803/mg  
 Number of Rows 1  
 Orientation Right Angle  
 PCB Locator No  
 PCB Mounting Surface Mount  
 PCB Retention Yes  
 Packaging Type Embossed Tape on Reel  
 Pitch - Mating Interface 0.50mm  
 Plating min - Mating 0.102µm  
 Plating min - Termination 1.016µm  
 Polarized to PCB Yes  
 Stackable No  
 Surface Mount Compatible (SMC) N/A  
 Temperature Range - Operating -20°C to +85°C  
 Wire/Cable Type FFC/FPC

**Electrical**

Current - Maximum per Contact 0.5A  
 Voltage - Maximum 50V

**Material Info**

**Reference - Drawing Numbers**

Packaging Specification SPK-51281-001-001  
 Product Specification PS-51281-003-001  
 Sales Drawing SD-51281-011, SD-51281-012

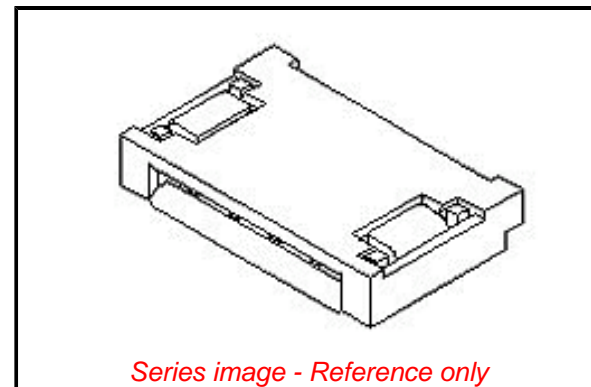

**EU ELV**

**Not Relevant**

**EU RoHS**

**Compliant**

**REACH SVHC**

Not Contained Per  
 -ED/01/2018 (15  
 January 2018)

**Halogen-Free**

**Status**

**Low-Halogen**

**Need more information on product environmental compliance?**

Email [productcompliance@molex.com](mailto:productcompliance@molex.com)  
 Please visit the [Contact Us](#) section for any non-product compliance questions.

China ROHS

ELV

RoHS Phthalates

Green Image

Not Relevant

Not Contained

**Search Parts in this Series**

[51281 Series](#)

**PLEASE CHECK [WWW.MOLEX.COM](http://WWW.MOLEX.COM) FOR LATEST PART INFORMATION**