

LOC	DIST	REVISIONS					
E	B	P	LTR	DESCRIPTION	DATE	DWN	APVD
			BA	NEW RELEASE	23DEC2010	PT	St.P

FOR FURTHER INFORMATION SEE DATA SHEET FOR
SERIES SM - SMD MOULDED POWER RESISTOR

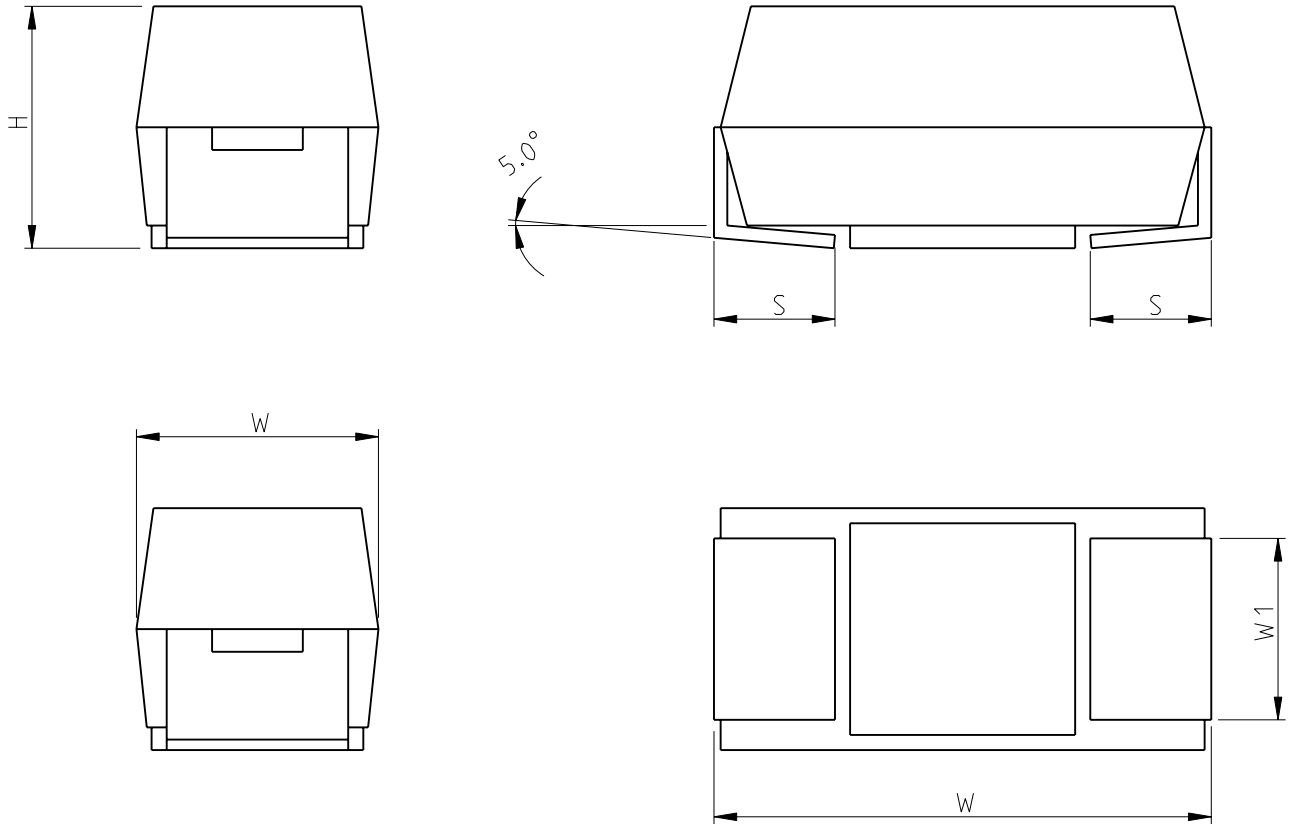

CASE CODE	DIMENSIONS (mm)				
	L	W	H	S	W1
A	3.2±0.2	1.6±0.2	1.6±0.2	0.8±0.3	1.2±0.1
B	3.5±0.2	2.8±0.2	1.9±0.2	0.8±0.3	2.2±0.1
C	6.0±0.2	3.2±0.2	2.5±0.2	1.3±0.2	2.2±0.0
D	7.3±0.2	4.3±0.2	2.8±0.2	1.3±0.2	2.4±0.0

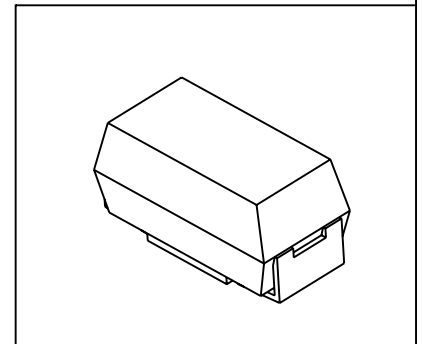

2008

RELEASED FOR PUBLICATION

THIS DRAWING IS UNPUBLISHED.

BY TYCO ELECTRONICS CORPORATION. ALL RIGHTS RESERVED.

DIMENSIONS: mm	DWN PARUSURAM.T	23DEC2010	MATERIAL	-	FINISH	-
	CHK ALLAN.P	23DEC2010	Tyco Electronics Corporation Dorcan, Swindon, SN3 5HH			
TOLERANCES UNLESS OTHERWISE SPECIFIED:	APVD STEPHEN.P	23DEC2010				
0 PLC ±0.2	PRODUCT SPEC	-	NAME EXTENDED RANGE TANTALUM CAPACITORS SERIES TYTM			
1 PLC ±0.1	APPLICATION SPEC	-	SIZE	CAGE CODE	DRAWING NO	RESTRICTED TO
2 PLC ±			A 4	00779	©-1676904	-
3 PLC ±			CUSTOMER DRAWING			
4 PLC ±	WEIGHT	-	SCALE	10:1	SHEET	1 OF 1
ANGLES ±5°			REV BC			