

147.0MHz SAW Filter

AFS147.0W01-TE



RoHS
Compliant



5.0 x 5.0 x 1.7mm

FEATURES:

- Low insertion loss, 6.5dB
- Amplitude ripple, 2.1dB
- Suitable for RoHS compliant reflow

APPLICATIONS:

- Pager
- FRS filter

STANDARD SPECIFICATIONS:

Maximum Ratings

Item	Value
Operating Temperature Range	-10°C to + 50°C
Storage Temperature Range	-40°C to + 85°C
DC Voltage	10V
Maximum Input Power	0 dBm

Electrical Characteristics

Parameters	Minimum	Typical	Maximum	Units	Notes
Center Frequency (f_c)	-----	147	-----	MHz	
Insertion Loss (IL)	-----	-----	6.5	dB	143 ~ 151MHz
Amplitude Ripple (A.R.)	-----	-----	2.1	dB	143 ~ 151MHz
Attenuation: (Reference level from 0dB)	50	-----	-----	dB	47 ~ 108.2MHz
	42	-----	-----		185.8 ~ 247MHz
Input Impedance (Please see note)	-----	390Ω//300pF	-----		147MHz
Output Impedance (Please see note)	-----	1164Ω//374pF	-----		147MHz

NOTES:

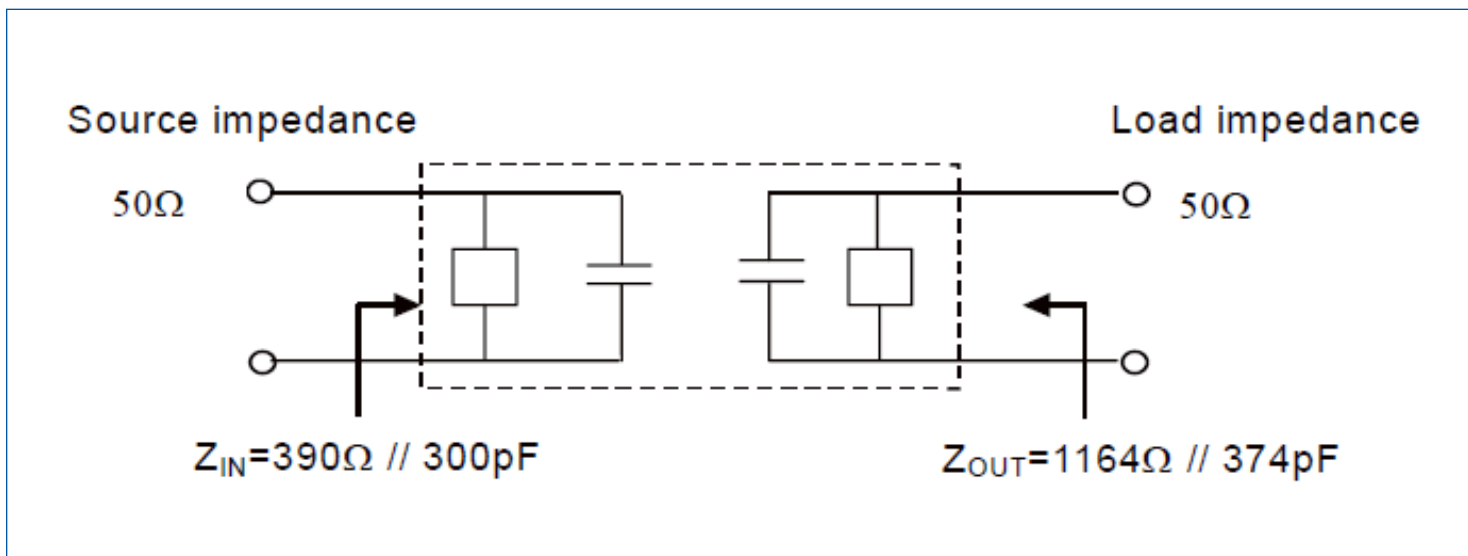

147.0MHz SAW Filter

AFS147.0W01-TE



RoHS
Compliant



5.0 x 5.0 x 1.7mm

TEST CIRCUIT

Network analyzer

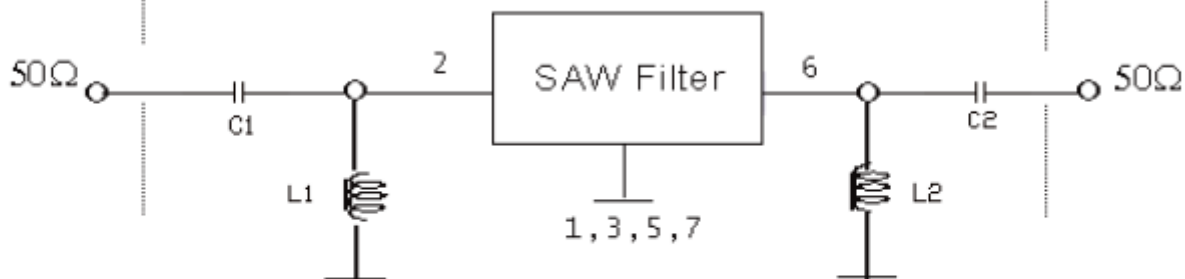

C1 = 8 pF L1 = 56 nH

C2 = 12 pF L2 = 47 nH

FREQUENCY CHARACTERISTIC

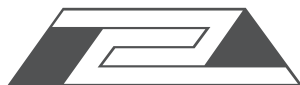
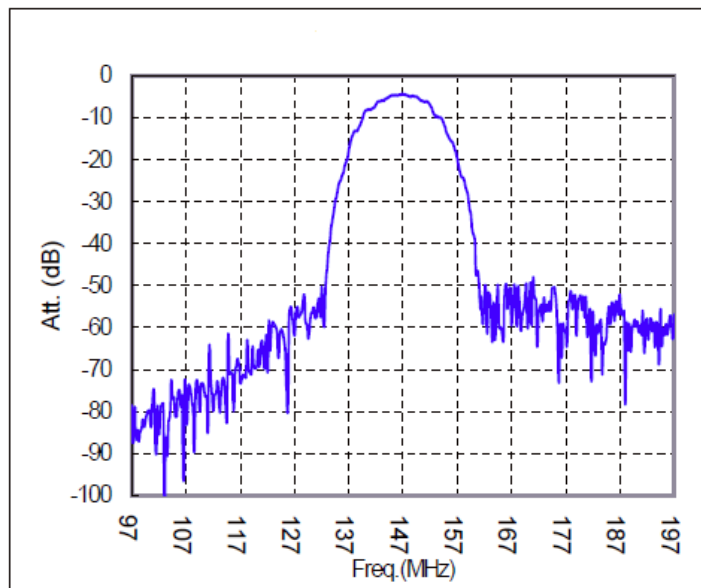
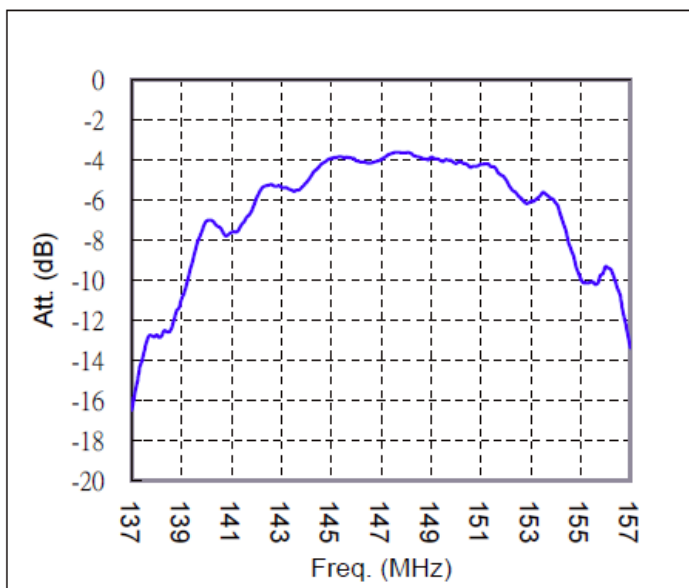

147.0MHz SAW Filter

AFS147.0W01-TE



RoHS
Compliant



5.0 x 5.0 x 1.7mm

OUTLINE DRAWING:

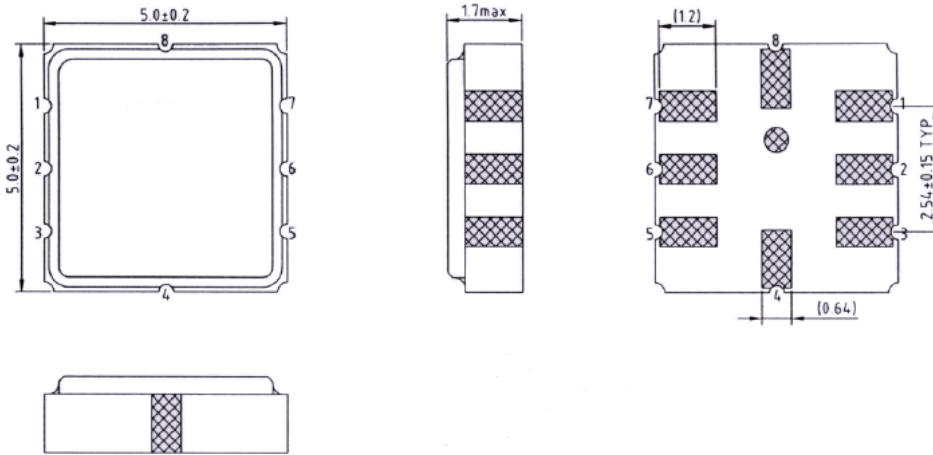

#2: Input
#6: Output
#1, 3, 5, 7: Ground

Dimensions: mm

PACKAGING: 3000pcs/reel

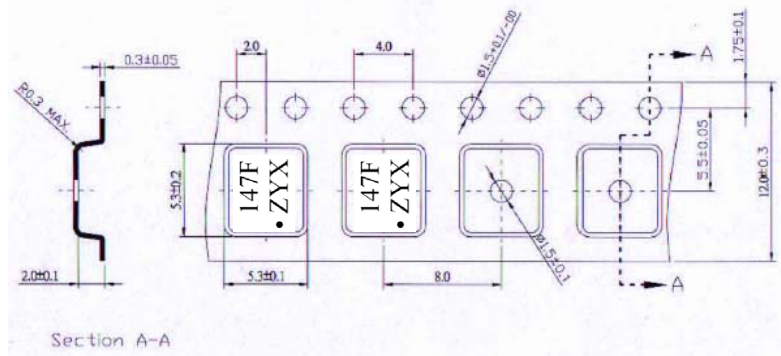
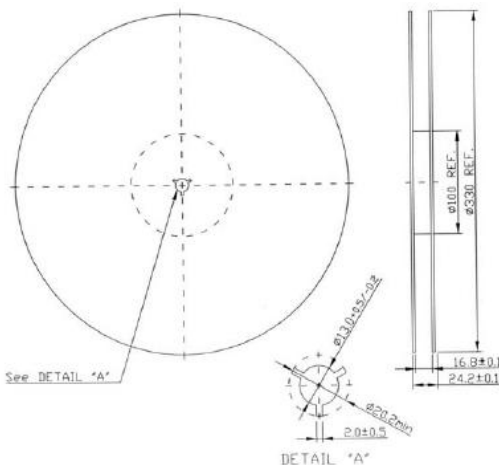

Dimensions: mm

REFLOW PROFILE

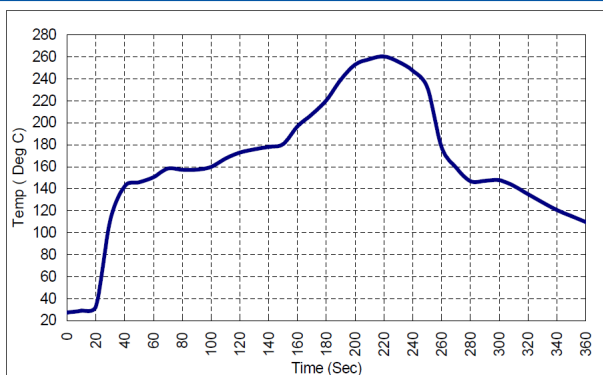

ATTENTION: Abracon Corporation's products are COTS – Commercial-Off-The-Shelf products; suitable for Commercial, Industrial and, where designated, Automotive Applications. Abracon's products are not specifically designed for Military, Aviation, Aerospace, Life-dependant Medical applications or any application requiring high reliability where component failure could result in loss of life and/or property. For applications requiring high reliability and/or presenting an extreme operating environment, written consent and authorization from Abracon Corporation is required. Please contact Abracon Corporation for more information.

ABRACON IS
ISO 9001:2008
CERTIFIED



ABRACON
CORPORATION

Visit www.abracon.com for Terms & Conditions of Sale
30332 Esperanza, Rancho Santa Margarita, California 92688
tel 949-546-8000 | fax 949-546-8001 | www.abracon.com

Revised: 06.15.11