

MicroSmart



UL Listed
File No. E211795

Key features of the MicroSmart series include:

- 10, 16, or 24 I/O All-in-one type CPU modules with Sink/Source DC input and Relay Output
- 20 I/O Slim type CPU modules with Sink/Source DC input and Transistor Sink or Source Output
- 20 I/O Slim type CPU modules with Sink/Source DC input and Relay Output with high-speed Transistor Sink or Source Output
- 40 I/O Slim type CPU modules with Sink/Source DC input and Transistor Sink or Source Output
- AC Input, DC Input, Relay Output, Transistor Output, Combination I/O and Analog I/O expansion modules available
- 24 I/O All-in-one CPU expandable to 88 I/O points; 20 I/O slim types expandable up to 148 or 244 I/O; 40 I/O slim type expandable up to 264 I/O points
- Standard RS232 port, optional plug-in RS485/RS232 port
- Optional memory cartridge or real-time clock and calendar cartridge
- Data link to other MicroSmart modules, PLCs, PCs or HG series operator interfaces
- Approved for Class 1–Div. 2 hazardous locations (UL1604)
- Compact size

Pulse Output/Trapezoidal Control

Independent dual-axis control is available with two pulse outputs. Locational values can be easily defined for precise positional (trapezoidal) control.

- Pulse output instruction
- PWM instruction (Pulse Width Modulation control)

Pulse Output Function Specifications

Number of output points	2
Maximum output frequency	20 kHz

*Only one point of trapezoidal control is available.

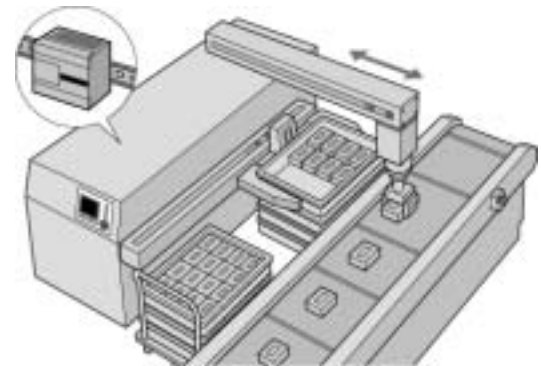
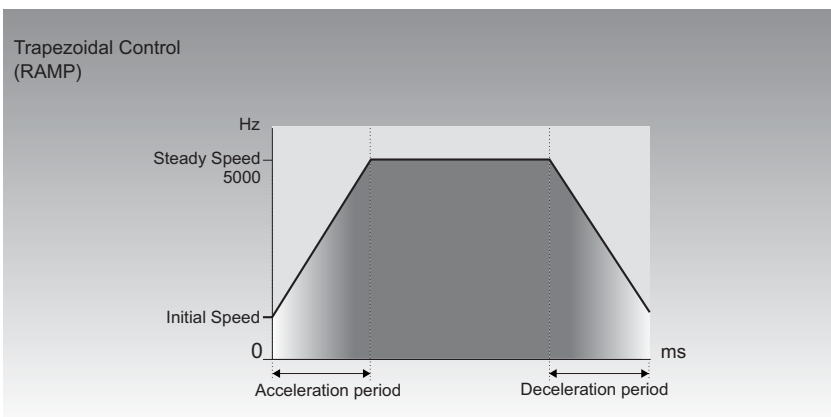

Setting the desired values enables you to precisely manage the trapezoidal control

Operation mode (S1)	1
Steady pulse frequency (S1 + 1)	50
Initial pulse frequency (S1 + 2)	10
Frequency change rate (S1 + 3)	2
Present value (S1 + 6, 7)	10,000

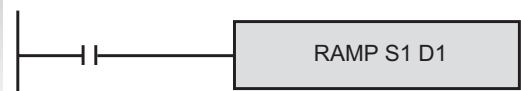

J Programmable Logic Controllers

CPU and Module Combination Examples

All-In-One Type

- Attach Maximum 4 Expansion Modules
- Maximum I/O 88 points
- Only FC4A-C24R2/C24R2C CPU Module is expandable



The maximum number of relay outputs that can be turned on simultaneously is 33 points including relay outputs on the CPU module.

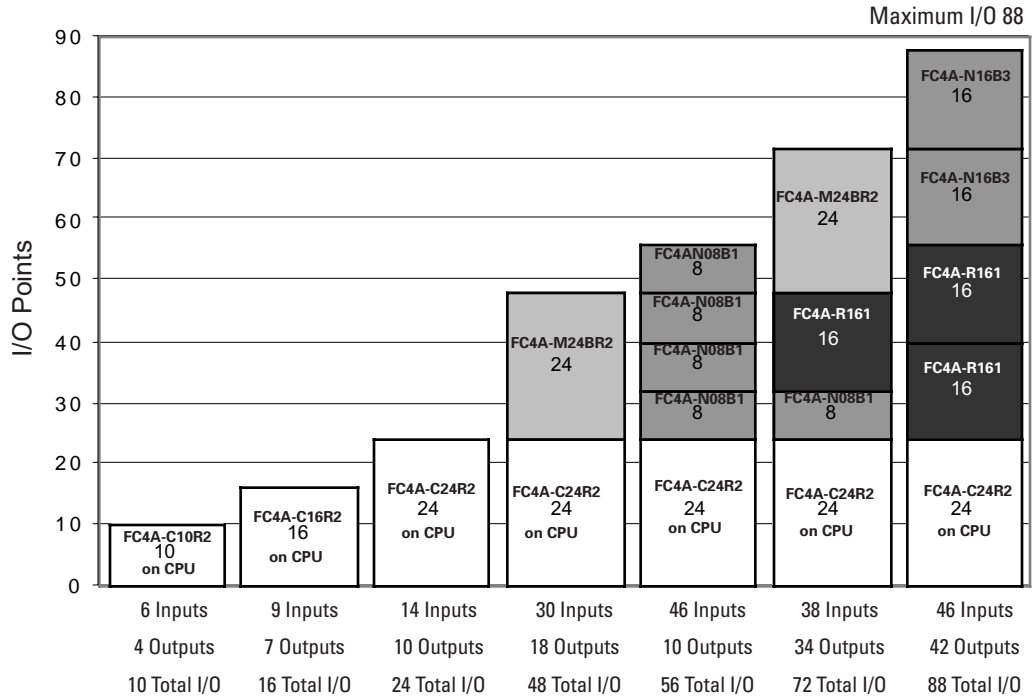

Slim Type



Programmable Logic Controllers

- Attach Maximum 7 Expansion Modules
- Maximum I/O
 - 148 points (D20K3, D20S3)
 - 244 points (D20RK1, D20RS1)
 - 264 points (D40K3, D40S3)



The maximum number of relay outputs that can be turned on simultaneously is 54 points including relay outputs on the CPU module.

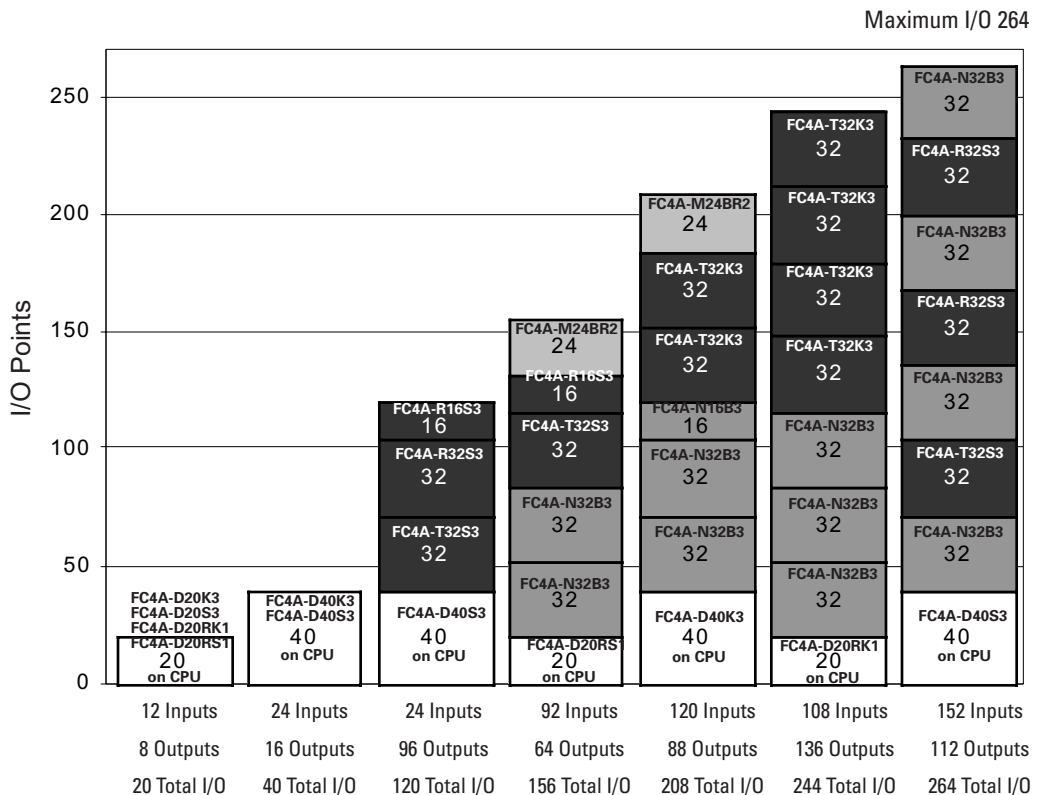

PID Control

To automatically maintain a target water temperature (PID control), use the auto tuning function to perform sampling. Based on the determined PID parameters, PID control is executed automatically. (Slim type CPU units only.)

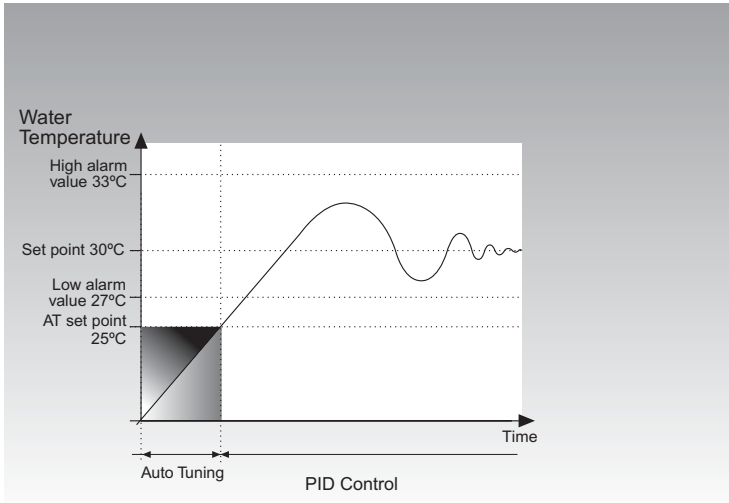

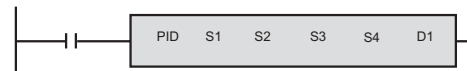

Set point	30
AT set point	25
High alarm value	35
Low alarm value	27



CPU Modules - All-in-One Type

Part Numbers



AC Power Type	FC4A-C10R2*	FC4A-C16R2*	FC4A-C24R2
DC Power Type	FC4A-C10R2C*	FC4A-C16R2C*	FC4A-C24R2C
Item			
I/O Points	10 (6 in/ 4 out)	16 (9 in/7 out)	24 (14 in/10 out)
Output Type	Relay Output, 240V AC/30V DC, 2A		
Input Type	24V DC (Sink/Source)		
Power Voltage	AC	100-240V AC, 50/60 Hz	
	DC	24V DC	
Memory	4.8KB	15KB	27KB
Expandability	N/A*	N/A	88 maximum I/O (up to 4 expansion I/O modules)





- * I/O expansion modules not applicable to these two models.
- For specifications see page J-15 & for dimensions see page J-25.
- For options see J-11 & for accessories see J-12.

J Programmable Logic Controllers

CPU Modules - Slim Type

Part Number	FC4A-D20K3	FC4A-D20RK1	FC4A-D40K3
Item			
I/O Points	20 (12 in/ 8 out)*	20 (12 in/ 8 out)	40 (24 in/16 out)**
Output Type	Transistor Sink Output 0.3A	Relay Output, 240V AC/30V DC, 2A* Sink Output 0.3A*	Transistor Sink Output 0.3A
Input Type	24V DC (Sink/Source)		
Power Voltage	24V DC		
Memory	27KB	31.2KB	31.2KB
Expandability	148 maximum I/O (up to 7 expansion modules)	244 maximum I/O (up to 7 expansion modules)	264 maximum I/O (up to 7 expansion modules)

Part Number	FC4A-D20S3	FC4A-D20RS1	FC4A-D40S3
Item			
I/O Points	20 (12 in/ 8 out)*	20 (12 in/ 8 out)	40 (24 in/16 out)**
Output Type	Transistor Source Output 0.3A	Relay Output, 240V AC/30V DC, 2A* Transistor, Source Output 0.3A*	Transistor Source Output 0.3A
Input Type	24V DC (Sink/Source)		
Power Voltage	24V DC		
Memory	27KB	31.2KB	31.2KB
Expandability	148 maximum I/O (up to 7 expansion modules)	244 maximum I/O (up to 7 expansion modules)	264 maximum I/O (up to 7 expansion modules)







1. * Transistor output 2 points and relay output 6 points.
2. **For MIL connector type modules, see page J-12 for cables and breakout modules.
3. For specifications see page J-15 & for dimensions see page J-25.
4. For options see J-11 & for accessories see J-12.

J

Programmable Logic Controllers









Input Modules - 5 Types

Part Number	FC4A-N08B1	FC4A-N16B1	FC4A-N16B3	FC4A-N32B3	FC4A-N08A11
Item					
Input Points	8-point DC	16-point DC	16-point DC*	32-point DC*	8-point AC
Input Type	24V DC (Sink/Source)				100 - 120V AC
Power Voltage	24V DC				100 - 120V AC (50/60Hz)
Terminal	Removable screw terminal	Removable screw terminal	MIL connector	MIL connector	Removable screw terminal



1. For specifications see page J-19 & for dimensions see page J-25.
2. For options see J-11 & for accessories see J-12.
3. *For MIL connector type modules, see page J-12 for cables and breakout modules.



Output Modules - 8 Types

Part Number	FC4A-R081	FC4A-R161	FC4A-T08K1	FC4A-T08S1
Item				
Output Points	8-point Relay	16-point Relay	8-point Transistor	8-point Transistor
Output Type	Relay Output (1NO contact), 240V AC/30V DC, 2A		Transistor sink output 0.3A	Transistor Source Output 0.3A
Terminal	Removable screw terminal			
Part Number	FC4A-T16K3	FC4A-T16S3	FC4A-T32K3	FC4A-T32S3
Item				
Output Points	16-point Transistor	16-point Transistor	32-point Transistor	32-point Transistor
Output Type	Transistor sink output 0.1A*	Transistor source output 0.1A*	Transistor sink output 0.1A*	Transistor source output 0.1A*
Terminal	MIL connector			



1. For specifications see page J-19 & for dimensions see page J-25.
2. For options see J-11 & for accessories see J-12.
3. *For MIL connector type modules, see page J-12 for cables and breakout modules.





Combination I/O Modules - 2 Types

Part Number	FC4A-M08BR1	FC4A-M24BR2
Item		
I/O Points	8 (4 in/ 4 out)	24 (16 in/ 8 out)
Output Type	Relay Output, 240V AC/30V DC, 2A	
Input Type	24V DC (Sink/Source)	
Terminal	Removable terminal block	Wire clamp terminal



1. For specifications see page J-21 & for dimensions see page J-25.
2. For options see J-11 & for accessories see J-12.

Analog I/O Modules - 4 Types

Part Number	FC4A-K1A1	FC4A-J2A1	FC4A-L03AP1	FC4A-L03A1
Item				
I/O Points	1 Analog Output	2 Analog Inputs	2 Analog Inputs, 1 Analog Output	2 Analog Inputs, 1 Analog Output
Output Type	Voltage (0-10V DC) Current (4-20mA)	–	Voltage (0-10V DC) Current (4-20mA)	Voltage (0-10V DC) Current (4-20mA)
Input Type	–	Voltage (0-10V DC) Current (4-20mA)	Thermocouple Resistance thermometer (RTD)	
Terminal	Removable terminal block			



1. For specifications see page J-22 & for dimensions see page J-25.
2. For options see J-11 & for accessories see J-12.
3. New analog modules available Fall '05. See page J-4 for details.

Expansion Module Examples

Example 1





Module	Type No.	Input	Output
CPU	FC4A-C24R2	14	10
DC Input	FC4A-N16B1	16	0
DC Input	FC4A-N16B1	16	0
Relay Output	FC4A-R161	0	16
Relay Output	FC4A-R161	0	16
Total		46	42

Example 2



Module	Type No.	Input	Output
CPU	FC4A-C24R2	14	10
DC Input	FC4A-N08B1	8	0
DC Input/Relay Output	FC4A-M08BR1	4	4
Relay Output	FC4A-R081	0	8
Transistor Sink Output	FC4A-T08K1	0	8
Total		26	30

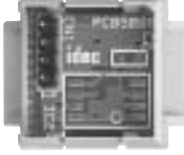
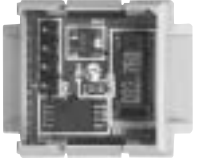

Optional Modules

Part Number	FC4A-HPH1	FC4A-PH1	FC4A-PM32 FC4A-PM64	FC4A-PT1
Item				
Type	HMI Base Module (does not come with HMI module)	HMI Module	Memory Cartridge	Clock Cartridge
Description	For mounting HMI module with slim type CPU module	For displaying and changing required operands	32KB or 64KB	–



1. For specifications see page J-24.





Communication Adapters

Part Number	FC4A-PC1	FC4A-PC2	FC4A-PC3
Item			
Type	RS232C	RS485	RS485
Terminal	Mini DIN	Mini DIN	Screw Terminal Type



1. For specifications see page J-24.
2. Used for All-In-One CPU units only, or for FC4A-HPH1 unit shown above.

Communication Modules for Slim Type CPUs

Part Number	FC4A-HPC1	FC4A-HPC2	FC4A-HPC3	FC4A-AS62M*
Item				
Type	RS232C	RS485	RS485	AS-Interface Master Module
Terminal	Mini DIN for Slim Type CPU Module	Mini DIN for Slim Type CPU Module	Screw Terminal Type for Slim Type CPU Module	–









1. For specifications see page J-24.
2. *FC4A-AS62M is compatible with CPUs: FC4A-D20RK1, FC4A-D20RS1, FC4A-D40K3, and FC4A-D40S3. (See Communication & Networking Section M for more information.)
3. New web server module available Fall '05. See page J-3 for details.

Accessories

MicroSmart Options

Item	Description	Length	Part Number
	Programming cable (Loader /user mode selectable)	3m/9.84'	FC4A-KC4CA
	O/I Interface Cable (MicroSmart port 1/2 RS232 to HG1B/2A)	1.5m/5'	FC4A-KC1CA
	O/I Interface Cable (MicroSmart port 1/2 RS232 to HG2F/3F/4F)		FC4A-KC2CA
	Modem Cable	3m/9.84'	FC2A-KM1C
	User Communication Cable	2.4m/7.87'	FC2A-KP1C
	Analog Voltage Input Cables (included with slim type CPU only)	1m/3.28'	FC4A-PMAC2P
	USB/RS232 Converter		FC4A-USB

MIL Connector Cables (Use with Breakout Modules)

Item	Length	Part Number
Non-Shielded 	0.5m	FC9Z-H050B20
	1m	FC9Z-H100B20
	2m	FC9Z-H200B20
	3m	FC9Z-H300B20
Shielded 	0.5m	FC9Z-H050A20
	1m	FC9Z-H100A20
	2m	FC9Z-H200A20
	3m	FC9Z-H300A20
Shielded Single Connectors 	5 ft	FC9Z-H100C20A
Non-Shielded 	0.5m	FC9Z-H050B26
	1m	FC9Z-H100B26
	2m	FC9Z-H200B26
	3m	FC9Z-H300B26
Shielded 	0.5m	FC9Z-H050A26
	1m	FC9Z-H100A26
	2m	FC9Z-H200A26
	3m	FC9Z-H300A26
Shielded Single Connectors 	5 ft	FC9Z-H100C26A

Breakout Modules

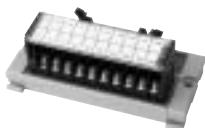
Item	Description	Part Number
	20 points (for 16 & 32 I/O expansion modules)	BX1D-S20A
	26 points (for 20 & 40 I/O CPU modules)	BX1D-S26A









J
Programmable Logic Controllers

Accessories con't

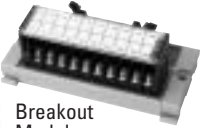











Item	Description	Pkg Qty	Part Number
	13-position terminal blocks for slim type CPU modules (TB1 for FC4A-D20RK1/-D20RS1)	2	FC4A-PMT13P
	16-position terminal blocks for slim type CPU modules (TB2 for FC4A-D20RS1)	2	FC4A-PMTS16P
	16-position terminal blocks for slim type CPU modules (TB2 for FC4A-D20RK1)	2	FC4A-PMTK16P
	11-position terminal blocks for I/O modules (8 point I/O modules)	2	FC4A-PMT11P
	10-position terminal blocks for I/O module (16 point I/O modules)	2	FC4A-PMT10P
	Direct Mounting Strips (for direct mounting of slim type CPU or I/O modules on a panel)	5	FC4A-PSP1P
	End Clips		BNL6
	DIN Rails (1m/3.28' long, 7.5mm height)		BAA1000
	DIN Rails (1m/3.28' long, 10.5mm height)		BNDN1000
	White IDEC screwdriver (2.5mm)		FC9Z-SD2
	Blue IDEC screwdriver (3.5mm)		FC9Z-SD1
	20-position connector socket (MIL connector for I/O modules)	2	FC4A-PMC20P
	26-position connector socket (MIL connector for Slim Type CPU)	2	FC4A-PMC26P
	14-point input simulator switch (Use with FC4A-C24R2 & FC4A-C24R2C)		FC4A-DS824-SW14
	9-point input simulator switch (Use with FC4A-C16R2 & FC4A-C16R2C)		FC4A-DS824-SW9
	6-point input simulator switch (Use with FC4A-C10R2 & FC4A-C10R2C)		FC4A-DS824-SW6
	MicroSmart Users Manual		FC9Y-B812-0A
	Windows-based programming software for IDEC PLCs (for more information, see page J-44).		WINDLDR

MicroSmart Packages

MicroSmart Starter Kits

Part Number	Includes	
	 Input Simulator Switch  Screwdriver  Breakout Module  15w Power Supply  HMI Display & Base Module  26-Wire I/O Cable	 WindLDR Cables  Manuals
MM-SMART-10	FC4A-C10R2, Input Simulator Switch, Screwdriver	WindLDR, Cables & Manuals
MM-SMART-16	FC4A-C16R2, Input Simulator Switch, Screwdriver	WindLDR, Cables & Manuals
MM-SMART-24	FC4A-C24R2, Input Simulator Switch, Screwdriver	WindLDR, Cables & Manuals
MM-SMART-20	FC4A-D20RK1, HMI Display & Base Module, 15w Power Supply, Screwdriver	WindLDR, Cables & Manuals
MM-SMART-40	FC4A-D40K3, HMI Display & Base Module, 15w Power Supply, 26-Wire I/O Cable & Breakout Module, Screwdriver	WindLDR, Cables & Manuals

MicroSmart Solution Packages

	Part Number	Micro Smart CPU	Operator Interface	Power Supply	Accessories	
				 15W  50W	 WindLDR  Cables  WindMSG  Manuals  WindO/I-NV2	
	MM-SMART-10-252	10 I/O	HG1X 2 line	—	WindLDR, WindMSG, Cables & Manuals	—
	MM-SMART-16-452	16 I/O	HG1X 4 line	—	WindLDR, WindMSG, Cables & Manuals	—
	MM-SMART-10-HG1B	10 I/O	HG1B RS232/485	15W	WindLDR, WindO/I-NV2, Cables & Manuals	E-Stop & Nameplate
	MM-SMART-16-HG1B	16 I/O	HG1B RS232/485	15W	WindLDR, WindO/I-NV2, Cables & Manuals	E-Stop & Nameplate
	MM-SMART-24-HG1B	24 I/O	HG1B RS232/485	15W	WindLDR, WindO/I-NV2, Cables & Manuals	E-Stop & Nameplate
	MM-SMART-20-HG1B	20 I/O	HG1B RS232/485	50W	WindLDR, WindO/I-NV2, Cables & Manuals	E-Stop & Nameplate
	MM-SMART-40-HG1B	40 I/O	HG1B RS232/485	50W	WindLDR, WindO/I-NV2, Cables & Manuals	E-Stop & Nameplate
	MM-SMART-16-HG2F-M	16 I/O	HG2F Monochrome	15W	WindLDR, WindO/I-NV2, Cables & Manuals	E-Stop & Nameplate
	MM-SMART-16-HG2F-C	16 I/O	HG2F Color	15W	WindLDR, WindO/I-NV2, Cables & Manuals	E-Stop & Nameplate
	MM-SMART-24-HG2F-M	24 I/O	HG2F Monochrome	15W	WindLDR, WindO/I-NV2, Cables & Manuals	E-Stop & Nameplate
	MM-SMART-24-HG2F-C	24 I/O	HG2F Color	15W	WindLDR, WindO/I-NV2, Cables & Manuals	E-Stop & Nameplate
	MM-SMART-20-HG2F-M	20 I/O	HG2F Monochrome	50W	WindLDR, WindO/I-NV2, Cables & Manuals	E-Stop & Nameplate
	MM-SMART-20-HG2F-C	20 I/O	HG2F Color	50W	WindLDR, WindO/I-NV2, Cables & Manuals	E-Stop & Nameplate
	MM-SMART-40-HG2F-M	40 I/O	HG2F Monochrome	50W	WindLDR, WindO/I-NV2, Cables & Manuals	E-Stop & Nameplate
	MM-SMART-40-HG2F-C	40 I/O	HG2F Color	50W	WindLDR, WindO/I-NV2, Cables & Manuals	E-Stop & Nameplate
	MM-SMART-24-HG3F	24 I/O	HG3F 10.4" TFT Color	60W	WindLDR, WindO/I-NV2, Cables & Manuals	E-Stop & Nameplate
	MM-SMART-24-HG4F	24 I/O	HG4F 12.1" TFT Color	60W	WindLDR, WindO/I-NV2, Cables & Manuals	E-Stop & Nameplate

Programmable Logic Controllers

General Specifications (CPU Module)

		FC4A-C10R2 FC4A-C10R2C	FC4A-C16R2 FC4A-C16R2C	FC4A-C24R2 FC4A-C24R2C	FC4A-D20K3 FC4A-D20S3	FC4A-D20RK1 FC4A-D20RS1	FC4A-D40K3 FC4A-D40S3	
CPU General Specifications	Rated Voltage	AC Power Type: 100-240V AC DC Power Type: 24V DC			24V DC			
	Allowable Range	AC Power Type: 85-264V AC DC Power Type: 16.0 - 31.2V DC			20.4 to 26.4V DC (including ripple)			
	Rated Frequency	AC Power Type: 50/60 Hz (47-63 Hz)			—			
	Maximum Input Current	0.25A (85V AC or 24V DC)	0.30A (85V AC or 24V DC)	0.45A (85V AC or 24V DC) **	0.56A (26.4V DC) #	0.70A (26.4V DC) #		
	Max. Power Consumption	AC	30VA/264V AC * 20VA/100V AC	31VA/264V AC * 22VA/100V AC	40VA/264V AC ** 33VA/100V AC	15W/26.4V DC #	19W/26.4V DC #	
		DC	3.8W/24V DC	4.6W/24V DC	8.7W/24V DC	Not applicable		
	Allowable Momentary Power Interruption	10 msec at the rated inputs and outputs (IEC61131)			10 msec (at 24V DC)			
	Dielectric Strength	Between power and ⊕ terminal: 1500V AC, 1 min Between I/O and ⊕ terminal: 1500V AC, 1 min			Between power and ⊕ terminal: 500V AC, 1 min Between I/O and ⊕ terminal: 1500V AC, 1 min			
	Insulation Resistance	Between power and ⊕ terminal: 10 MΩ (min), 500V DC Between I/O and ⊕ terminal: 10 MΩ (min), 500V DC			Between power and ⊕ terminal: 10 MΩ (min) Between I/O and ⊕ terminal: 10 MΩ (min)			
	Noise Resistance	AC or DC power terminal: 1.5 kV, 50ns to 1μs I/O terminal (coupling clamp): 1.5 kV, 50ns to 1μs			DC power terminals: 1.0 kV, 50 nsec to 1μsec I/O terminals (coupling clamp): 1.5 kV, 50 nsec to 1μsec			
	Inrush Current	35A max.	35A max.	40A max.	50A maximum (24V DC)			
	Power Supply Wire	22 - 18AWG						
	Operating Temperature	0 to 55°C						
	Storage Temperature	-25 to +70°C						
	Operating Humidity	30-95% Level RH1 (no condensation)						
	Altitude	Operation: 0 to 2,000m (0 to 6,595 ft) Transport: 0 to 3,000m (0 to 9,840 ft)						
	Pollution Degree	2 (IEC60664)						
	Corrosion Immunity	Free from corrosive gases						
	Degree of Protection	IP20						
Grounding Wire	16 AWG			22 AWG				
Vibration Resistance	DIN rail mounted: 10 to 57Hz / amplitude 0.075mm, 57 to 150Hz / acceleration 9.8m/s ² (1G) Direct mounted: 2 to 25Hz / amplitude 1.6mm, 25 to 100Hz / acceleration 39.2m/s ² (4B) in each of 3 axes							
Shock Resistance	15G, 11ms, 3 shocks in each of 3 axes							
Weight	AC	230g	250g	305g	Not Applicable			
	DC	240g	260g	310g	140g	185g	180g	



1. * CPU module power consumption includes 250 mA sensor power.
2. ** CPU module (including 250 mA sensor power) + 4 I/O modules
3. # CPU module + 7 I/O modules

Communication Port 1 Specifications

Standards	EIA RS232C
Maximum Baud Rate	19200 bps
Maintenance Communication	Possible
User Communication	Possible
Modem Communication	Not possible
Data Link Communication	Not possible
Cable	Special Cables: FC2A-KC4C, FC2A-KP1C, FC4A-KC1CA, FC4A-KC2CA
Isolation between Internal Circuit and Communication Port	Not isolated

Function Specifications (CPU Module)

	FC4A-C10R2 FC4A-C10R2C	FC4A-C16R2 FC4A-C16R2C	FC4A-C24R2 FC4A-C24R2C	FC4A-D20K3 FC4A-D20S3	FC4A-D20RK1 FC4A-D20RS1	FC4A-D40K3 FC4A-D40S3
Control System	Stored program system					
Instruction words	35 basic instructions					
	38 advanced	40 advanced	46 advanced	53 advanced	70 advanced	
Program Capacity	4,800 bytes (800 steps)	15,000 bytes (2,500 steps)	27,000 bytes (4,500 steps)	27,000 bytes (4,500 steps)	31,200 bytes (5,200 steps)	
	Calculated 6 bytes per step					
User Program Storage	Internal EEPROM, Memory cartridge (option: EEPROM)					
Processing Time	Basic instruction: 1.65 msec (1000 steps); END processing: 0.64 msec (does not include expansion I/O service, clock function processing, data link processing and interrupt processing)					
Expandable I/O Modules	—	—	4 modules	7 modules		
RAM Backup	Backup Data: Internal relay, shift register, counter, data register Backup Duration: Approx. 30 days (typical) at 25° C after backup battery fully charged Battery: Lithium secondary battery Charging Time: Approx. 15 hours for charging from 0% to 90% of full charge Battery Life: 5 years Replaceability: Impossible to replace battery					
I/O Points	6 input, 4 output	9 input, 7 output	14 input, 10 output Expansion: 64 I/O	12 input, 8 output Expansion: 128 I/O	12 input, 8 output Expansion: 224 I/O	24 input, 16 output Expansion: 224 I/O
Internal Relay	256	1024				
Shift Register	64	128				
Data Register	400	1300				
Expansion Data Register	—				6000	
Counter	32	100				
Timer (1-sec, 100-msec, 10-msec, 1-msec)	32	100				
Self-Diagnostic Function	Power failure check, watchdog timer, data link connection, user program EEPROM sum check, timer/counter preset value sum check, user program RAM sum check, keep data, user program syntax, user program writing, CPU module, clock IC, I/O bus initialize, user program execution					
Input Filter	3 to 15 msec (1-msec increments)					
Catch Input/Interrupt Input	4 input (I2 through I5) Minimum turn on pulse width: 40 µsec maximum Minimum turn off pulse width: 150 µsec maximum					
High-Speed Counter	Total 4 points: Single/two-phase selectable: 20kHz (1 point) Single-phase: 5kHz (3 points)			Total 4 points: Single/two-phase selectable: 20kHz (2 points) Single-phase: 5kHz (2 points)		
	Counting Range 0 to 65535 (16 bits), Operation Mode: Rotary encoder mode and adding counter mode					
Analog Potentiometer	1 point	2 points	1 point			
	Data Range: 0 to 255					
Analog Voltage Input	—			1 point, 0 to 10V DC Input Voltage Range, approx. 100kΩ Input Impedance, data range 0-255 (8 bit)		
Pulse Output	—			2 points, max. frequency 20kHz		
Sensor Power Supply	24V DC (+10% to -15%), 250 mA, no overload detection Isolated from the internal circuit			—		
Port 1	RS232C Maintenance Communication, User Communication, Modem Communication					
Port 2 (optional)	—	Possible: RS232C or RS485 (Maintenance communication, data link)				
Clock Function (optional)	Possible			Possible Year, month, day, day of week, hour, minute, second		
Memory Cartridge (optional)	Select either clock or memory cartridge			Possible		
HMI Module (optional)	Possible			Possible using HMI Base Module		

Programmable Logic Controllers CPU Function Specifications

DC Input/Relay Output Specifications (CPU Module)

DC Input Specifications for CPU modules

		FC4A-C10R2 FC4A-C10R2C	FC4A-C16R2 FC4A-C16R2C	FC4A-C24R2 FC4A-C24R2C	FC4A-D20K3 FC4A-D20S3	FC4A-D20RK1 FC4A-D20RS1	FC4A-D40K3 FC4A-D40S3
Rated Input Voltage		24V DC sink / source input signal					
Allowable Range		20.4 to 28.8V DC			20.4 to 26.4V DC		
Rated Input Current		I0, I1: 11mA, I2 to I7, I10 to I15: 7mA			I0, I1, I6, I7: 5mA/point, I2 to I5, I10 to I27: 7mA/point		
Input Impedance		I0, I1: 2.1kΩ, I2 to I7, I10 to I15: 3.4kΩ			I0, I1, I6, I7: 5.7kΩ, I2 to I5, I10 to I27: 3.4kΩ		
OFF/ON Time	OFF/ON	I0 to I5: 35μsec + Filter Value I6, I7, I10 to I15: 40μsec + Filter Value			I0 to I7: 35μsec + Filter Value I10 to I27: 40μsec + Filter Value		
	ON/OFF	I0, I1: 45μsec + Filter Value I2 to I7, I10 to I15: 150μsec + Filter Value			I0, I1, I6, I7: 45μsec + Filter Value I2 to I5, I10 to I27: 150μsec + Filter Value		
Input Points		6 inputs 6/1 common	9 inputs 9/1 common	14 inputs 14/1 common	12 inputs 12/1 common	12 inputs 12/1 common	24 inputs, 12/1 common
Connector	On Mother Board	—			FL26A2MA (Oki Electric Cable)	MC1.5/13-G-3.81BK (Phoenix Contact)	FL26A2MA (Oki Electric Cable)
	Insertion/Removal Durability	—			100 times minimum		
Isolation		Between input terminals: Not isolated Internal circuit: Photocoupler isolated					
Input Type		Type 1 (IEC61131)					
External Load for I/O Interconnection		Not needed					
Signal Determination Method		Static					
Effect of Improper Input Connection		Both sinking and sourcing input signals can be connected. If any input exceeding the rated value is applied, permanent damage may be caused.					
Cable Length		3m (9.84 ft)					

Relay Output Specifications for CPU modules

		FC4A-C10R2 FC4A-C10R2C	FC4A-C16R2 FC4A-C16R2C	FC4A-C24R2 FC4A-C24R2C	FC4A-D20RK1 FC4A-D20RS1
Output Points		4 points	7 points	10 points	8 points
Output Points per Common	COM0	3 points	4 points	4 points	2 points (transistor output)
	COM1	1 point	2 points	4 points	3 points
	COM2	—	1 point	1 point	2 points
	COM3	—	—	1 point	1 point
Type of Output		1NO			
Maximum Load Current	Per point	2A			
	Per Common	8A			
Minimum Switching Load		0.1mA, 0.1V DC (reference value)			
Initial Contact Resistance		30mΩ maximum			
Electrical Life		100,000 operations (rated load) @ 1,800 operations/hr			
Mechanical Life		200,000 operations (no load) @ 18,000 operations/hr			
Rated Load Current (resistive/inductive)		240V AC/2A, 24V DC/2A (30V DC / 2A)			
Dielectric Strength		Between output and ⊕ terminals: 1500V AC, 1 minute Between output terminals and internal circuit: 1500V AC, 1 minute Between output terminals (COMs): 1500 V AC, 1 minute			
Connector	On Mother Board	—			MC1.5/16-G-3.81BK (Phoenix Contact)
	Insertion/Removal Durability	—			100 times minimum

Transistor Sink and Source Output Specifications (CPU Module)

Transistor Sink and Source Output Specifications for CPU modules

		FC4A-D20K3 FC4A-D20S3	FC4A-D20RK1 FC4A-D20RS1	FC4A-D40K3 FC4A-D40S3
Output Points and Common Line		8 points, 8/1 common	2 points, 2/1 common	16 points, 8/1 common
Type of Output		FC4A-D20K3/D20RK1/D40K3 = Sink Output FC4A-D20S3/D20RS1/D40S3 = Source Output		
Rated Load Voltage		24V DC		
Operating Load Voltage Range		20.4 to 28.8V DC		
Rated Load Current		0.3A per output point		
Maximum Load Current		1A per common line		
Voltage Drop (ON Voltage)		1V maximum (voltage between COM and output terminals when output is on)		
Inrush Current		1A maximum		
Leakage Current		0.1 mA maximum		
Clamping Voltage		39V±1V		
Maximum Lamp Load		8W		
Inductive Load		L/R = 10ms (28.8V DC, 1Hz)		
External Current Draw		100mA maximum, 24V DC (power voltage at the +V or -V terminal)		
Isolation		Between output terminal and internal circuit: Photocoupler isolated Between output terminals: Not isolated		
Connector	On Mother Board	FL26A2MA (Oki Electric Cable)	MC1.5/16-G-3.81BK (Phoenix Contact)	FL26A2MA (Oki Electric Cable)
	Insertion/Removal Durability	100 times minimum		
Output Delay	Turn ON time	5 μs (Q0, Q1), 300 μs max (Q2 to Q7, Q10 to Q17)		
	Turn OFF time	5 μs (Q0, Q1), 300 μs max (Q2 to Q7, Q10 to Q17)		

J

Programmable Logic Controllers

Input/Relay Output Specifications (Expansion Modules)

Input Module Specifications

		DC Input				AC Input
		FC4A-N08B1	FC4A-N16B1	FC4A-N16B3	FC4A-N32B3	FC4A-N08A11
Input Points		8 points (8/1 common)	16 points (16/1 common)		32 points (16/1 common)	8 points (4/1 common)
Rated Input Voltage		24V DC sink/source input signal				100 - 120V AC (50-60Hz)
Input Voltage Range		20.4 to 28.8V DC				85 to 132V AC
Rated Input Current		7mA/point (24V DC)		5mA/point (24V DC)		7.5mA/pt (100V AC, 60Hz)
Input Impedance		3.4 kΩ		4.4 kΩ		0.8kΩ (60Hz)
Input Delay Time		ON time: 4 msec OFF time: 4 msec				ON time: 25 msec OFF time: 30 msec
Isolation	Between input terminals	Not isolated				In the same commons: not isolated In different commons: 500V
	Internal circuit	Photocoupler isolated				2500V (photocoupler isolated)
External Load for I/O Interconnection		Not needed				
Signal Determination Method		Static				
Effect of Improper Input Connection		Both sinking and sourcing input signals can be connected. If any input exceeding the rated value is applied, permanent damage may be caused.				
Cable Length		3m (9.84 ft) in compliance with electromagnetic immunity				
Connector	On Mother Board	MC1.5/10-G-3.81BK (Phoenix contact)		FL20A2MA (Oki Electric Cable)		
	Insertion/Removal Durability	100 times minimum				
Internal Current Draw	All Inputs ON	25 mA (5V DC) 0 mA (24V DC)	40 mA (5V DC) 0 mA (24V DC)	35 mA (5V DC) 0 mA (24V DC)	65 mA (5V DC) 0 mA (24V DC)	60mA (5V DC) 0mA (24V DC)
	All Inputs OFF	5 mA (5V DC) 0 mA (24V DC)	5 mA (5V DC) 0 mA (24V DC)	5 mA (5V DC) 0 mA (24V DC)	10 mA (5V DC) 0 mA (24V DC)	30mA (5V DC) 0mA (24V DC)
Weight		85g	100g	65g	100g	-

Relay Output Module Specifications

		FC4A-R081	FC4A-R161
Output Points and Common Lines		8 points (4/1 common)	16 points (8/1 common)
Output Type		1NO	
Maximum Load Current	per point	2A	
	per common	7A	8A
Minimum Switching Load		0.1 mA/0.1V DC (reference value)	
Initial Contact Resistance		30 mΩ maximum	
Electrical Life		100,000 operations minimum (rated load 1,800 operations/hour)	
Mechanical Life		20,000,000 operations minimum (no load 18,000 operations/hour)	
Rated Load (resistive/inductive)		240V AC/2A, 30V DC/2A	
Dielectric Strength		Between output and ⊕ terminals: 1500V AC, 1 minute Between output terminals and internal circuit: 1500V AC, 1 minute Between output terminals (COMs): 1500 V AC, 1 minute	
Connector	On Mother Board	MC1.5/11-G-3.81BK (Phoenix contact)	MC1.5/10-G-3.81BK (Phoenix contact)
	Insertion/Removal Durability	100 times minimum	
Internal Current Draw	All Inputs ON	30 mA (5V DC) 40 mA (24V DC)	45 mA (5V DC) 75 mA (24V DC)
	All Inputs OFF	5 mA (5V DC) 0 mA (24V DC)	5 mA (5V DC) 0 mA (24V DC)
Weight		110g	145g

Transistor Output Specifications (Expansion Modules)
Transistor Output Module Specifications

		FC4A-T08K1 FC4A-T08S1	FC4A-T16K3 FC4A-T16S3	FC4A-T32K3 FC4A-T32S3
Output Points		8 points (8/1 common)	16 points (16/1 common)	32 points (16/1 common)
Output Type		FC4A-T□K□: Transistor sink output FC4A-T□S□: Transistor source output		
Rated Load Voltage		24V DC		
Operating Load Voltage Range		20.4 to 28.8V DC		
Rated Load Current		0.3A per output point (at 28.8V DC)	0.1A per output point (at 28.8V DC)	
Maximum Load Current	per point	0.36A (at 28.8V DC)	0.12A (at 28.8V DC)	
	per common	3A (at 28.8V DC)	1A (at 28.8V DC)	
Voltage Drop (ON Voltage)		1V maximum (between COM and output terminals when output is on)		
Inrush Current		1A maximum		
Leakage Current		0.1A maximum		
Clamping Voltage		39V ± 1V		
Maximum Clamping Load		8W		
Inductive Load		L/R = 10 msec (DC 28.8V, 1Hz)		
External Current Draw		FC4A-T□K□: 100mA maximum, 24V DC (power voltage at the +V) FC4A-T□S□: 100mA maximum, 24V DC (power voltage at the -V)		
Isolation		Between output terminal and internal circuit: Photocoupler isolated Between output terminals: Not isolated		
Connector	Type (on Mother Board)	MC1.5/10-G-3.81BK (Phoenix contact)	FL20A2MA (Oki Electric Cable)	
	Insertion/Removal Durability	100 times minimum		
Internal Current Draw	All Inputs ON	10mA (5V DC) 20mA (24V DC)	10mA (5V DC) 40mA (24V DC)	20mA (5V DC) 70mA (24V DC)
	All Inputs OFF	5mA (5V DC) 0mA (24V DC)	5mA (5V DC) 0mA (24V DC)	10mA (5V DC) 0mA (24V DC)
Output Delay	Turn ON time	300µsec maximum		
	Turn OFF time	300µsec maximum		
Weight		85g	70g	105g

J

Programmable Logic Controllers

Combination I/O Specifications (Expansion Modules)

Combination I/O Module Specifications

		FC4A-M08BR1	FC4A-M24BR2	
DC Input Specifications	Input Points	4 points (4/1 common)	16 points (16/1 common)	
	Rated Input Voltage	24V DC sink/source input signal		
	Input Voltage Range	20.4 to 28.8V DC		
	Range Input Current	7 mA/point (24V DC)		
	Input Impedance	3.4 kΩ		
	Turn ON Time	4 msec (24V DC)		
	Turn OFF Time	4 msec (24V DC)		
	Isolation	Between input terminals: Not isolated Internal circuit: Photocoupler isolated		
	External Load for I/O Interconnection	Not needed		
	Signal Determination Method	Static		
	Effect of Improper Input Connection	Both sinking and sourcing input signals can be connected. If any input exceeding the rated value is applied, permanent damage may be caused.		
Cable Length	3m (9.84 ft) in compliance with electromagnetic immunity			
Relay Output Specifications	Output Points	4 points (4/1 common)	8 points (8/2 common)	
	Output Type	1NO		
	Maximum Load Current	per point	2A	
		per common	7A	
	Minimum Switching Load	0.1 mA/0.1V DC (reference value)		
	Initial Contact Resistance	30 mΩ maximum		
	Electrical Life	100,000 operations minimum (rated load 1,800 operations/hour)		
	Mechanical Life	20,000,000 operations minimum (no load 18,000 operations/hour)		
	Rated Load (resistive/inductive)	240V AC/2A, 30V DC/2A		
Dielectric Strength	Between output and ⊕ or ⊖ terminals: 1,500V AC, 1 minute Between output terminal and internal circuit: 1,500V AC, 1 minute Between output terminal (COMs): 1,500V AC, 1 minute			
Connector	on Mother Board	MC1.5/11-G-3.81BK (Phoenix contact)	Input: F6018-17P (Fujicon) Output: F6018-11P (Fujicon)	
	Insertion/Removal Durability	100 times minimum	—	
	Internal Current Draw	All Inputs ON	25 mA (5V DC) 20 mA (24V DC)	65 mA (5V DC) 45 mA (24V DC)
		All Inputs OFF	5 mA (5V DC) 0 mA (24V DC)	10 mA (5V DC) 0 mA (24V DC)
Weight	95g		140g	

Analog I/O Specifications (Expansion Modules)

Analog I/O Module Specifications

	FC4A-L03A1	FC4A-L03AP1	FC4A-J2A1	FC4A-K1A1
Input Points	2	2	2	—
Input Signal Type	Voltage Input (0 to 10V DC) Current Input (4 to 20 mA DC)	Thermocouple Resistance Thermometer	Voltage Input (0 to 10V DC) Current Input (4 to 20 mA DC)	—
Output Points	1	1	—	1
Output Signal Type	Voltage Output (0 to 10V DC) Current Output (4 to 20 mA DC)	Voltage Output (0 to 10V DC) Current Output (4 to 20 mA DC)	—	Voltage Output (0 to 10V DC) Current Output (4 to 20 mA DC)
Rated Power Voltage	24V DC			
Allowable Voltage Range	20.4 to 28.8V DC			
Connector	On Mother Board			
	MC1.5/11-G-3.81BK (Phoenix contact)			
Internal Current Draw	Insertion/Removal Durability			
	100 times minimum			
Internal Current Draw	Internal Power	50 mA (5V DC) 0 mA (24V DC)	50 mA (5V DC) 0 mA (24V DC)	50 mA (5V DC) 0 mA (24V DC)
	External Power	40 mA (24V DC)	40 mA (24V DC)	40 mA (24V DC)
Weight	85g			

Analog Output Specifications

		FC4A-L03A1, FC4A-L03AP1, FC4A-K1A1	
		Voltage Output	Current Output
Output Signal Type			
Output Range		0 to 10V DC	4 to 20 mA DC
Load Impedance		2 kΩ minimum	300Ω maximum
Applicable Load Type		Resistive load	
Setting Time		20 msec	
Total Output System Transfer Time		20 msec + 1 scan time	
Output Error	Maximum Error at 25°C	±0.2% of full scale	
	Temperature Coefficient	±0.015% of full scale/°C	
	Repeatability after Stabilization Time	±0.5% of full scale	
	Output Voltage Drop	±1% of full scale	—
	Non-linearity	±0.2% of full scale	
	Output Ripple	1 LSB maximum	
	Overshoot	0%	
	Total Error	±1% of full scale	
Data	Digital Resolution	4096 increments (12 bits)	
	Output Value of LSB	2.5 mV	4 μA
	Data Type in Application Program	0 to 4095 (12-bit data); -32768 to 32767 (optional range designation) See note on page J-23	
	Monotonicity	Yes	
Noise	Current Loop Open	—	Detectable (See note on page J-23)
	Maximum Temporary Deviation during Electrical Noise Tests	±3% max. when a 500V clamp is applied to the power and I/O wiring	
	Cable	Twisted pair shielded cable recommended for improved noise immunity	
	Crosstalk	No crosstalk because of 1 channel output	
Dielectric Strength		500V between output and power circuit	
Type of Protection		Photocoupler between output and internal circuit	
Effect of Improper Output Connection		No damage	
Selection of Analog Output Signal Type		Using software programming	
Calibration or Verification to Maintain Rated Accuracy		Impossible (approx. 10 years)	

J Programmable Logic Controllers

Analog Input Specifications (Expansion Modules)

Analog Input Specifications

		FC4A-L03A1, FC4A-J2A1		FC4A-L03AP1		
Input Signal Type		Voltage Input	Current Input	Thermocouple	Resistance Thermometer	
Input Range		0 to 10V DC	4 to 20 mA DC	Type K (0 to 1300°C) Type J (0 to 1200°C) Type T (0 to 400°C)	Pt 100 3-wire type (-100 to 500°C)	
Input Impedance		1 MΩ minimum	10Ω	1 MΩ minimum	1 MΩ minimum	
Allowable Conductor Resistance		—	—	—	200Ω maximum	
Input Detection Current		—	—	—	1.0 mA maximum	
Sample Duration Time		16 msec maximum		50 msec maximum		
Sample Repetition Time		16 msec maximum		50 msec maximum		
Total Input System Transfer Time		32 msec + 1 scan time *		100 msec + 1 scan time *		
Type of Input		Single-ended input	Differential input			
Operating Mode		Self scan				
Conversion Method		ΣΔ type ADC				
Input Error	Maximum Error at 25°C	±0.2% of full scale		±0.2% of full scale plus reference junction compensa- tion accuracy (±4°C maximum)	±0.2% of full scale	
	Temperature Coefficient	±0.006% of full scale / °C				
	Repeatability after Stabilization Time	±0.5% of full scale				
	Non-linearity	±0.2% of full scale				
	Maximum Error	±1% of full scale				
Data	Digital Resolution	4096 increments (12 bits)				
	Input Value of LSB	2.5 mV	4 μA	K: 0.325°C; J: 0.300°C; T: 0.100°C	0.15°C	
	Data Type in Application Program	0 to 4095 (12-bit data); -32768 to 32767 (optional range designation) **				
	Monotonicity	Yes				
	Input Data Out of Range	Detectable #				
Noise Resistance	Maximum Temporary Deviation during Electrical Noise Tests	±3% maximum when a 500V clamp voltage is applied to the power and I/O wiring			Accuracy is not assured when noise is applied	
	Common Mode Characteristics	Common mode reject ratio (CMRR): -50 dB				
	Common Mode Voltage	16V DC				
	Input Filter	No				
	Cable	Twisted pair shielded cable recommended for improved noise immunity		—		
	Crosstalk	2 LSB maximum				
Dielectric Strength		500V between input and power circuit				
Type of Protection		Photocoupler between input and internal circuit				
Effect of Improper Input Connection		No damage				
Maximum Permanent Allowed Overload (No damage)		13V DC	40 mA DC	—		
Selection of Analog Input Signal Type		Using software programming				
Calibration or Verification to Maintain Rated Accuracy		Impossible (approx. 10 years)				

J

Programmable Logic Controllers



NOTES FOR ANALOG EXPANSION UNITS:

- * Total input system transfer time = Sample repetition time x 2 + 1 scan time
- ** The 12-bit data (0 to 4095) processed in the analog I/O module can be linear-converted to a value between -32768 and 32767. Select the optional range designations and analog I/O data minimum and maximum values by using data registers allocated to analog I/O modules.
- # When an error is detected, a corresponding error code is sorted to a data register allocated to analog I/O operating status.

Communication Adapter and Communication Module Specifications (Expansion Modules)

Communication Adapter and Communication Module Specifications

	FC4A-PC1 FC4A-HPC1	FC4A-PC2 FC4A-HPC2	FC4A-PC3 FC4A-HPC3
Standards	EIA RS232C	EIA RS485	EIA RS485
Maximum Baud Rate	19200 bps	19200 bps	Computer link: 19200 bps Data link: 38400 bps
Maintenance Communication	Possible	Possible	Possible
User Communication	Possible	Impossible	Impossible
Modem Communication	Possible	Impossible	Impossible
Data Link Communication	Impossible	Impossible	Possible
Maximum Cable Length	special cable	special cable	200m
Quantity of Slave Stations	—	—	31
Isolation between Internal Circuit and Communication Port	Not isolated		
Recommended Cable for RS485	—	—	Twisted-pair shielded cable with a minimum core wire of 0.3 mm ²
Conductor Resistance	—	—	85 Ω/km maximum
Shield Resistance	—	—	20 Ω/km maximum

Option Specifications

Optional HMI Module Specifications

	FC4A-PH1
Power Voltage	5V DC (supplied from the CPU module)
Internal Current Draw	200mA DC
Weight	20g

Optional Memory Cartridge Specifications

	FC4A-PM32	FC4A-PM64
Memory Type	EEPROM	
Accessible Memory Capacity	32 KB	64 KB
Hardware for Storing Data	CPU module	
Software for Storing Data	WindLDR	
Quantity of Store Programs	One user program can be stored on one memory cartridge	

Optional Clock Cartridge Specifications

	FC4A-PT1
Accuracy	±30 sec/month (typical) at 25°C
Backup Duration	Approx. 30 days (typical) at 25°C after backup battery fully charged
Battery	Lithium secondary battery
Charging Time	Approx. 10 hours for charging from 0% to 90% of full charge
Replaceability	Impossible to replace battery

Dimensions

CPU Modules:

all dimensions in mm

FC4A-C10R2, FC4A-C16R2
FC4A-C10R2C, FC4A-C16R2C

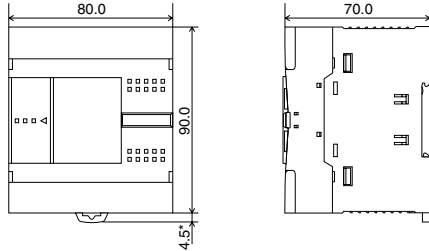

FC4A-C24R2, FC4A-C24R2C

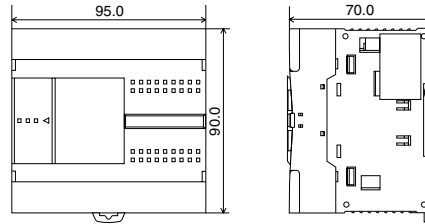

FC4A-D20K3, FC4A-D20S3

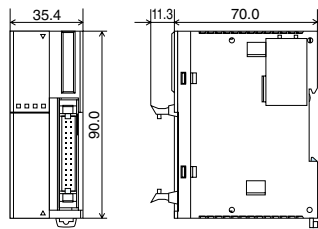

FC4A-D20RK1, FC4A-D20RS1

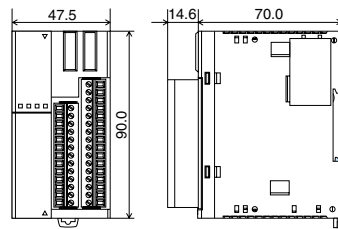

FC4A-D40K3, FC4A-D40S3

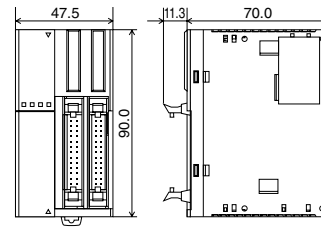

Expansion Modules:

FC4A-N08B1, FC4A-N08A11, FCA-T08K1,
FC4A-M08BR1, FC4A-L03AP1, FC4A-K1A1
FC4A-R081, FC4A-T08S1, FC4A-L03A1,
FC4A-J2A1

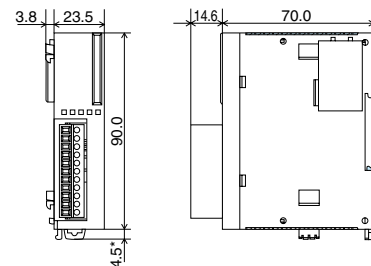

FC4A-N16B3, FC4A-T16K3, FC4A-T16S3

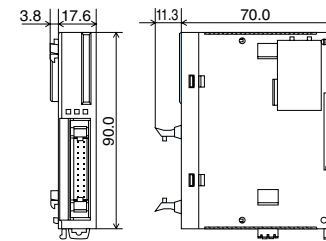

FC4A-HPC1, FC4A-HPC2, FC4A-HPC3

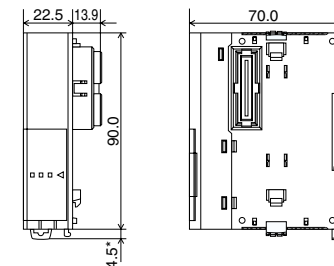

FC4A-N16B1, FC4A-R161

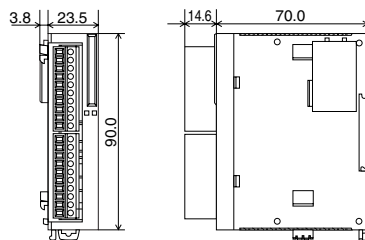

FC4A-N32B3, FC4A-T32K3, FC4A-T32S3

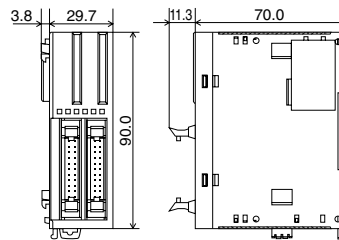

FC4A-HPH1

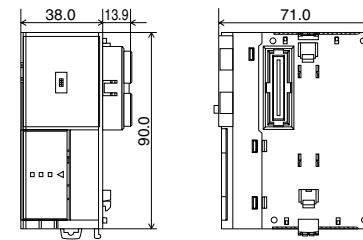

FC4A-M24BR2

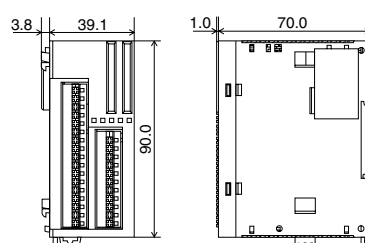

Example:
This figure illustrates a system setup with the FC4A-C24R2 All-in-one type CPU, an 8-point relay output module, and a 16-point DC input module, mounted on a 35mm DIN rail using BNL6 mounting clips.

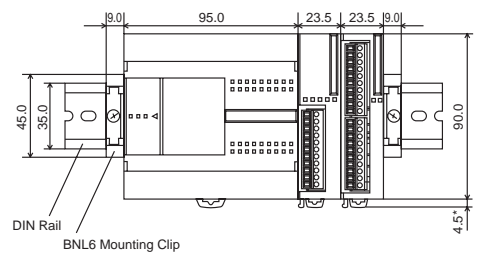

Mounting Hole Layout

CPU Modules:

**FC4A-C10R2, FC4A-C10R2C
FC4A-C16R2, FC4A-C16R2C**

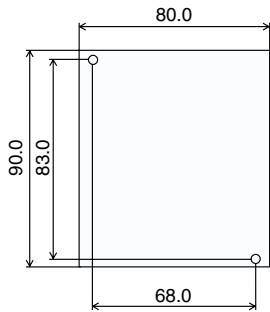

FC4A-C24R2, FC4A-C24R2C

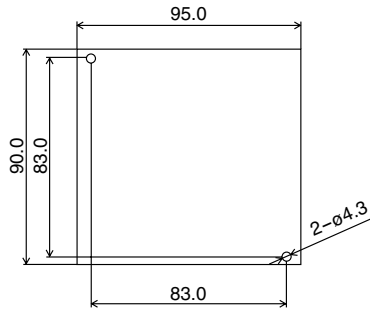

**FC4A-C20K3
FC4A-D20S3**

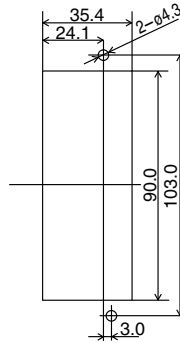

**FC4A-C20RK1, FC4A-D40K3
FC4A-C20RS1, FC4A-D40S3**

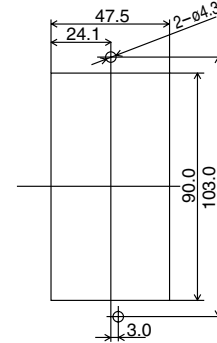

Expansion Modules:

**FC4A-N08B1, FC4A-N08A11,
FC4A-N16B1, FC4A-R081,
FC4A-R161, FC4A-T08K1,
FC4A-T08S1, FC4A-M08BR1,
FC4A-L03A1, FC4A-L03AP1,
FC4A-J2A1, FC4A-K1A1**

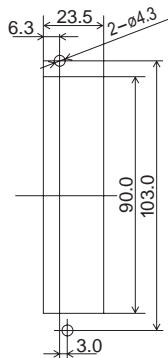

**FC4A-N16B3
FC4A-T16K3
FC4A-T16S3**

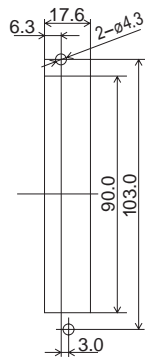

**FC4A-N32B3
FC4A-T32K3
FC4A-T32S3**

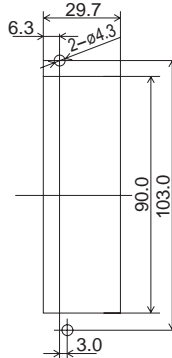

EXAMPLE:
Mounting hole layout for FC4A-C24R2 and 23.5mm-wide I/O modules.

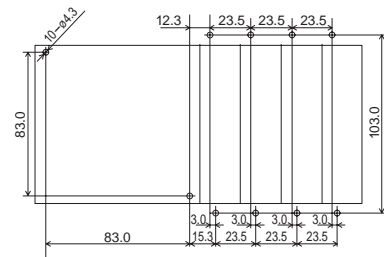

FC4A-M24BR2

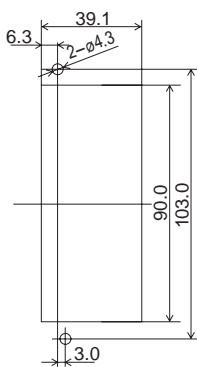

**FC4A-HP1C
FC4A-HPC2
FC4A-HPC3**

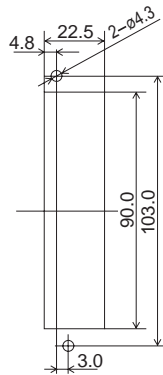

FC4A-HPH1

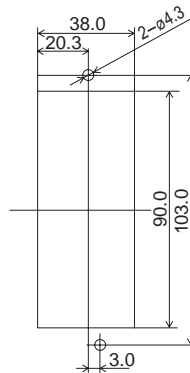

EXAMPLE:
Mounting hole layout for, from left, FC4A-HPH1, FC4A-D20K3, FC4A-N16B3, FC4A-N32B3, and FC4A-M24R2 modules.

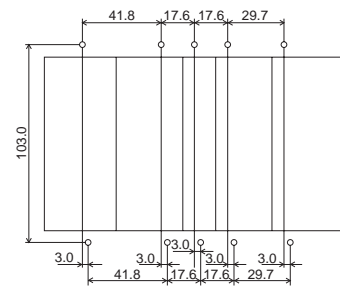

J

Programmable Logic Controllers

Usage Limits

I/O Usage Limits

All-in-one Type CPU Modules:

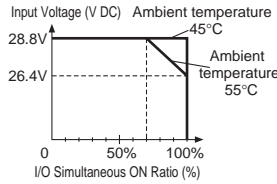
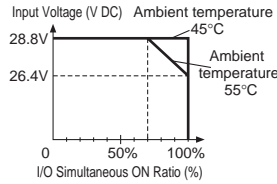
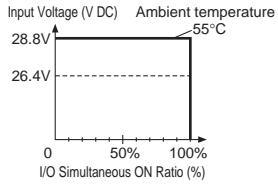

When using at an operating ambient temperature above 40°C, reduce the input voltage or the quantity of I/O points that turn on simultaneously.

Slim Type CPU Modules:

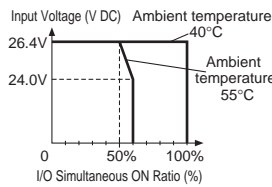
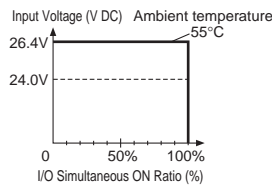
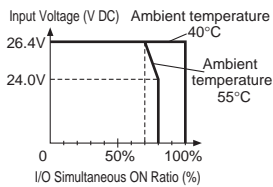

Input Usage Limits

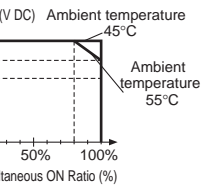
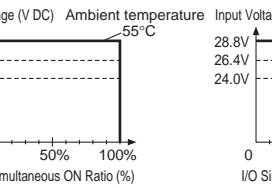
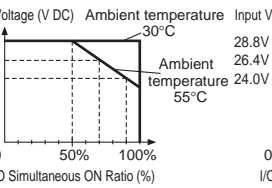
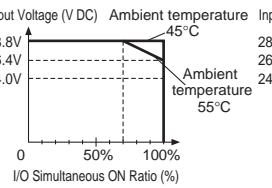
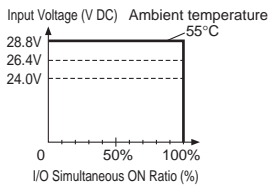

Internal Circuits

Input Internal Circuits

ALL-IN-ONE TYPE

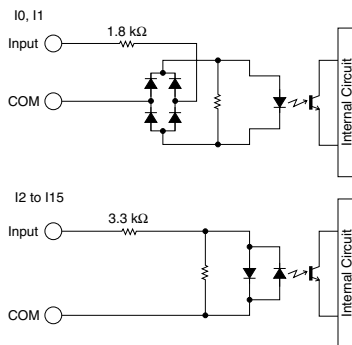

SLIM TYPE

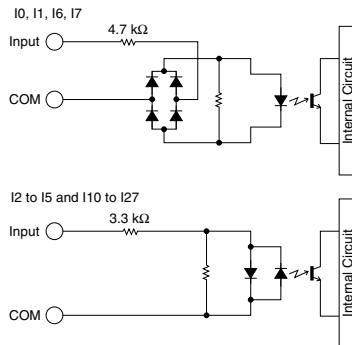

Output Internal Circuit (Slim Type)

SINK OUTPUT

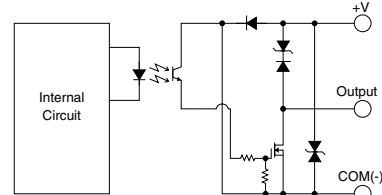

SOURCE OUTPUT

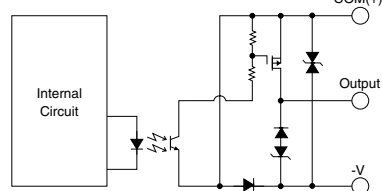

Internal Circuits

Input Internal Circuits (Expansion Modules)

Output Internal Circuits

FC4A-N081, FC4A-N16B1

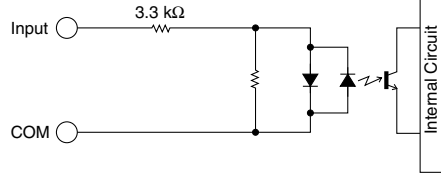

FC4A-N16B3, FC4A-N32B3

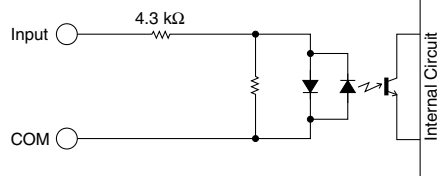

FC4A-M08BR1, FC4A-M24BR2

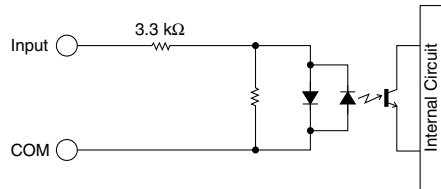

FC4A-N08A11

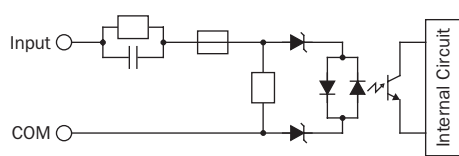

FC4A-T08K1, FC4A-T16K3, FC4A-T32K3

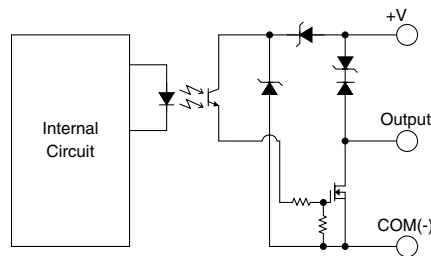

FC4A-T08S1, FC4A-T16S3, FC4A-T32S3

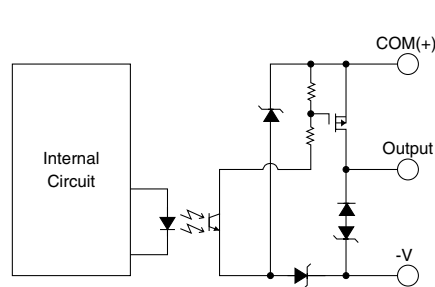

J

Programmable Logic Controllers

Analog I/O Module

Input Circuit

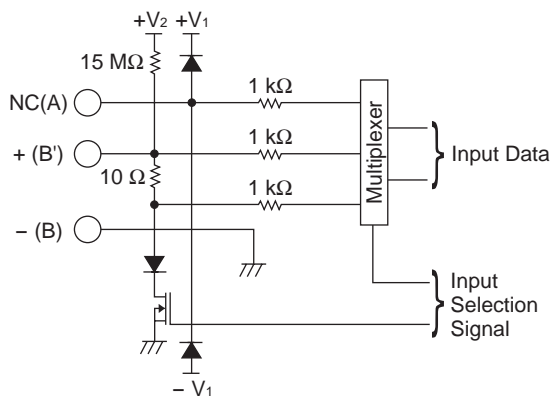

Output Circuit

