

PLEASE CHECK WWW.MOLEX.COM FOR LATEST PART INFORMATION

Part Number: [0015058178](#)
Status: **Active**
Description: 2.54mm (.100") Pitch Black Polyester IDT Cover, Feed-To, 17 Circuits

Documents:

[3D Model](#) [RoHS Certificate of Compliance \(PDF\)](#)
[Drawing \(PDF\)](#)

General

| | |
|----------------|-------------------------------|
| Product Family | Accessories |
| Series | 7841 |
| Component Type | Cover |
| Product Name | IDT (Insulation Displacement) |

Physical

| | |
|---------------------|-------|
| Circuits (Loaded) | 17 |
| Color - Resin | Black |
| Lock to Mating Part | No |
| Packaging Type | Bag |

Material Info

| | |
|-----------------|-----------|
| Old Part Number | 7841-B17B |
|-----------------|-----------|

Reference - Drawing Numbers

| | |
|---------------|--------------|
| Sales Drawing | SD-7841-**** |
|---------------|--------------|

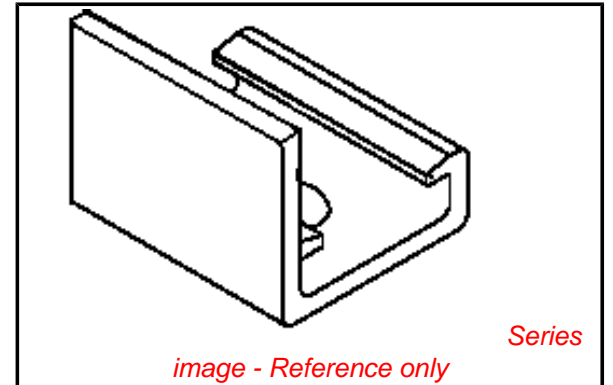

EU RoHS

**ELV and RoHS
Compliant**
**REACH SVHC
Not Reviewed**
**Low-Halogen Status
Not Reviewed**

China RoHS



**Need more information on product
environmental compliance?**

Email productcompliance@molex.com
 For a multiple part number RoHS Certificate of
 Compliance, [click here](#)

Please visit the [Contact Us](#) section for any
 non-product compliance questions.

Search Parts in this Series

7841Series