

PLEASE CHECK WWW.MOLEX.COM FOR LATEST PART INFORMATION

Part Number: [0440500007](#)
Status: **Active**
Overview: [Magnetic and Modular Jacks and Plugs](#)
Description: [Modular Jack, Right Angle, Low Profile, 8/8](#)

Documents:

3D Model	Packaging Specification PK-44050-004 (PDF)
Drawing (PDF)	Test Summary TS-44050-001 (PDF)
Product Specification PS-44050-003 (PDF)	RoHS Certificate of Compliance (PDF)

Agency Certification

CSA	LR19980
UL	E107635

General

Product Family	Modular Jacks/Plugs
Series	44050
Component Type	PCB Jack
Magnetic	No
Overview	Magnetic and Modular Jacks and Plugs
Performance Category	5, 5e
Power over Ethernet (PoE)	N/A
Product Name	Modular Jack 8/8, RJ45
UPC	800754846103

Physical

Boot Color	N/A
Color - Resin	Black
Durability (mating cycles max)	500
Flammability	94V-0
Inverted / Top Latch	No
Jack Height	13.06mm
Lightpipes/LEDs	None
Material - Metal	Brass, Phosphor Bronze
Material - Plating Mating	Gold
Material - Plating Termination	Tin
Material - Resin	High Temperature Thermoplastic
Net Weight	5.267/g
Orientation	Right Angle (Side Entry)
PCB Locator	Yes
PCB Retention	Yes
PCB Thickness - Recommended	1.57mm
Packaging Type	Tray
Pitch - Mating Interface	1.02mm
Pitch - Termination Interface	1.27mm
Plating min - Mating	1.270µm
Plating min - Termination	2.540µm
Ports	1
Positions / Loaded Contacts	8/8
Surface Mount Compatible (SMC)	Yes
Temperature Range - Operating	-40°C to +85°C
Termination Interface: Style	Through Hole
Waterproof / Dustproof	No
Wire/Cable Type	N/A

Electrical

Current - Maximum per Contact	1.5A
-------------------------------	------

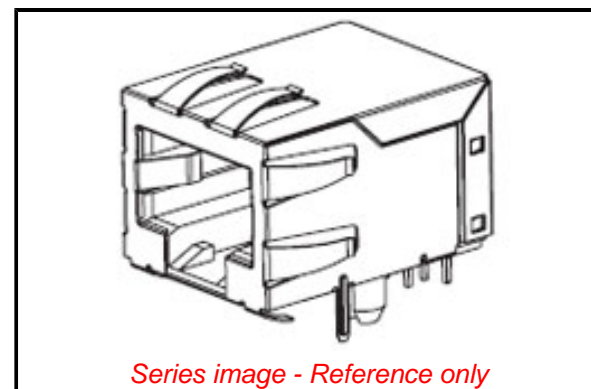

EU ELV

Not Relevant

EU RoHS

Compliant

REACH SVHC

Not Contained Per
-ED/01/2018 (15
January 2018)

Halogen-Free

Status

Not Low-Halogen

Need more information on product environmental compliance?

Email productcompliance@molex.com
Please visit the [Contact Us](#) section for any non-product compliance questions.

China ROHS	Green Image
ELV	Not Relevant
RoHS Phthalates	Not Contained

Search Parts in this Series

[44050 Series](#)

Mates With

FCC 68 Plugs

Grounding to Panel	Location E, With All Panel Grounding Tab
Shielded	Yes
Voltage - Maximum	150V AC (RMS)

Solder Process Data

Duration at Max. Process Temperature (seconds)	005
Lead-free Process Capability	WAVE
Max. Cycles at Max. Process Temperature	001
Process Temperature max. C	260

Material Info**Reference - Drawing Numbers**

Packaging Specification	PK-44050-004
Product Specification	PS-44050-003
Sales Drawing	SD-44050-002
Test Summary	TS-44050-001

This document was generated on 07/16/2018

PLEASE CHECK WWW.MOLEX.COM FOR LATEST PART INFORMATION