

PLEASE CHECK WWW.MOLEX.COM FOR LATEST PART INFORMATION

Part Number: **0755860004**
Status: **Active**
Overview: iPass Connector System
Description: 0.80mm Pitch, iPass I/O Surface Mount Receptacle, Right Angle, External Application, 26 Circuit, 0.38µm Gold (Au)

Documents:

3D Model	Application Specification AS-75586-001-001 (PDF)
Drawing (PDF)	Packaging Specification PK-75586-002 (PDF)
Product Specification PS-75586-001-001 (PDF)	Packaging Specification PK-75586-101 (PDF)
Application Specification AS-170432-0003 (PDF)	RoHS Certificate of Compliance (PDF)

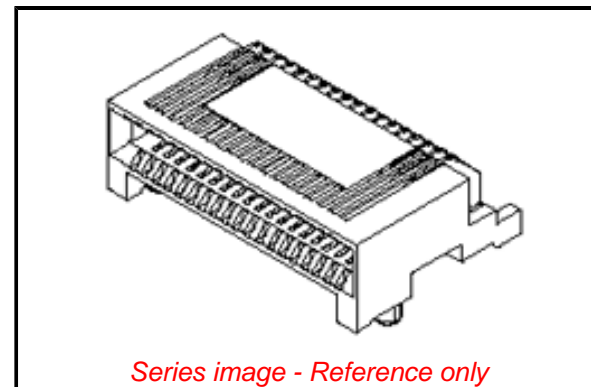

Agency Certification

CSA	LR19980
UL	E29179

General

Product Family	I/O Connectors
Series	<u>75586</u>
Application	Wire-to-Board
Component Type	Receptacle
Electrical Model	Yes
Overview	<u>iPass Connector System</u>
Product Name	iPass, Mini Multi-Lane, PCI Express
Type	N/A
UPC	822348851829

Physical

Boot Color	N/A
Circuits (Loaded)	26
Circuits (maximum)	26
Color - Resin	Black
Durability (mating cycles max)	50
Flammability	94V-0
Gender	Female
Keying to Mating Part	None
Lock to Mating Part	None
Material - Metal	High Performance Alloy (HPA)
Material - Plating Mating	Gold
Material - Plating Termination	Tin
Material - Resin	High Temperature Thermoplastic
Net Weight	0.723/g
Number of Rows	2
Orientation	Right Angle
PCB Locator	Yes
PCB Retention	None
PCB Thickness - Recommended	1.35mm
Packaging Type	Embossed Tape on Reel
Panel Mount	No
Pitch - Mating Interface	0.80mm
Pitch - Termination Interface	0.80mm
Plating min - Mating	0.381µm
Plating min - Termination	2.540µm
Polarized to Mating Part	Yes
Polarized to PCB	Yes
Ports	1
Surface Mount Compatible (SMC)	Yes

EU ELV

Compliant

EU RoHS

Compliant

REACH SVHC

Not Contained Per
-ED/01/2018 (15
January 2018)

Halogen-Free

Status

Low-Halogen

Need more information on product environmental compliance?

Email productcompliance@molex.com
Please visit the [Contact Us](#) section for any non-product compliance questions.

China ROHS	Green Image
ELV	Compliant
RoHS Phthalates	Not Contained

Search Parts in this Series

75586 Series

Mates With

74547 iPass Cable Assembly

Use With

74548 I/O Connectors

Temperature Range - Operating	-40°C to +80°C
Termination Interface: Style	Surface Mount
Waterproof / Dustproof	No
Wire Insulation Diameter	N/A
Wire Size AWG	N/A

Electrical

Current - Maximum per Contact	0.5A
Grounding to Panel	N/A
Shielded	No
Voltage - Maximum	30V AC (RMS)/DC

Solder Process Data

Duration at Max. Process Temperature (seconds)	020
Lead-free Process Capability	REFLOW
Max. Cycles at Max. Process Temperature	001
Process Temperature max. C	260

Material Info**Reference - Drawing Numbers**

Application Specification	AS-170432-0003, AS-75586-001-001
Electrical Model Document	EE-75586-001
Packaging Specification	PK-75586-002, PK-75586-101
Product Specification	PS-75586-001-001
S-Parameter Model	SP-75586-001
Sales Drawing	SD-75586-001

This document was generated on 07/16/2018

PLEASE CHECK WWW.MOLEX.COM FOR LATEST PART INFORMATION