

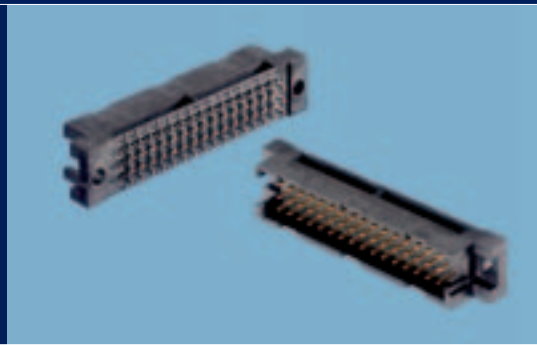

DIN 41612 / 60603-2 Connectors and completions

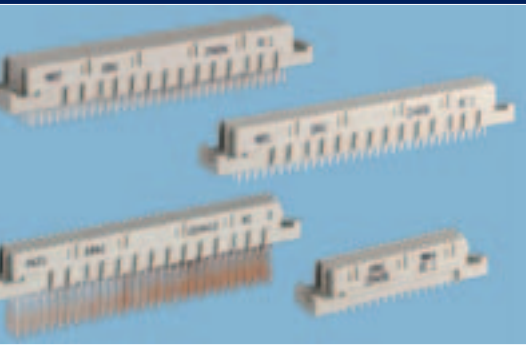



DIN 41612 / IEC 60603-2 Connectors General information	3
Main features	3
Early mate/late break	3
Pre-centering	4
Codings	4
Retentive clip	4
Wiring accessories	5
Termination Technique	5
Basic dimensions for all sizes of the connector family according to DIN 41612/IEC 60603-2	6
Important dimensions	6
Mounting dimensions of the connectors	7
Clearance and creepage distances	8
Minimum clearance and creepage distances according to IEC 60664	8
DIN 41612 / 60603-2 Pressfit Connectors ERNIPRESS™	9
Required specifications of the PCB	9
Insertion and retention forces	9
Hole design	10
Press-in tools	10
Vertical Pressfit Connectors	10
Right Angle Pressfit Connectors	11
Ordering Information Pressfit Connectors	11
Electrical and Mechanical Characteristics	13
Type B Male	21
Type B/2 Male	25
Type B/3 Male	29
Type B Female	33
Type B/2 Female	36
Type B/3 Female	39
Type Q Male	42
Type Q/2 Male	45
Type Q/3 Male	45
Type Q Female	46
Type Q/2 Female	49
Type Q/3 Female	49
Type C Male	50
Type C/2 Male	56
Type C/3 Male	60
Type C Female	63
Type C/2 Female	74
Type C/3 Female	78
Type R Male	81
Type R/2 Male	86
Type R/3 Male	89
Type R Female	92
Type R/2 Female	96
Type R/3 Female	99
Type CD Male	102
Type CD Female	105
Type RD Male	108
Type RD Female	111
Type E 160 / E 80 Male	114
Type E 160 Female	117
Type TE Male	120



Type TE Female	123
Eurocard Center Connector	126
Type D Male	129
Type D Female	132
Type E Male	136
Type E Female	139
Type F Male	143
Type F Female	145
Type M Male	151
Type M Female	154
Special Contacts for Type M Male and Female	161
Type H11	165
Type H11 Male	168
Type H11 Female	169
Type H15	170
Type H15 Male	173
Type H15 Female	175
Type H7/F24	176
Type H7/F24 Male	179
Type H7/F24 Female	180
Insulation Displacement Connector (IDC)	181
Application example for DIN-IDC connectors	183
Crimp snap-in Connectors (CST)	185
Guide Elements and Shrouds	190
Coding Systems	192
Applications	198
Part Number Index	199

General information

The DIN 41612/IEC 60603-2 connector family consists of 13 basic sizes and many complementary versions. It was developed for use in 19" rack systems in accordance with **DIN 41494 / IEC 60297**. The large number of different sizes and the efficient connection techniques have made it possible to install these connectors for in extremely wide range of applications.

Typical areas of application:

- Connection between plug-in card and back-panel wiring
- Connection between two PCB's arranged one above the other
- Connection to peripheral equipment with connector housings as accessories
- As periphery connectors for external interfaces from the wiring side

Main features

- Separable printed circuit board connectors
 - International approvals, such as UL or CSA
 - 13 connector sizes with the same plug-in and mounting conditions
 - Additional connector sizes complementing the DIN 41612/IEC 60603-2 such as half or tripled sizes
 - Different coding systems available
 - Up to 160 contacts per connector
 - Two to five row connectors possible
 - Various termination types available
 - 2.54 mm (0.1") basic pitch
 - Early mate/late break contacts available on request
 - Wide range of accessories
 - Complete interface system available
 - All female connectors mentioned in this data sheet have **dual sided female contact spring**.
- This contact principle offers a max. security in contacting and remaining contact resistance in extreme situations.

Early mate/late break

For the connectors size B, C, Q, R, D, E and F 0.8 mm early mate/late break male contacts can be loaded in any position in rows a, b, c, d, e and z.

The early mate/late break of the high current connector sizes H11 and H15 have a length of 3.5 mm (1,5 mm on request). Other lengths of early mate/late break contacts on request.

Mating length

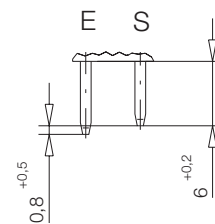

E = early mate, late break

S = standard

Pre-centering

For applications with early mate/late break contacts the male connector insulators with pre-centering ensure even more reliable mating.

The insulators of the female connectors have a recess at the appropriate point. The dimensions of these versions do not conform to the specifications of DIN 41612/IEC 60603-2.

The ordering details are not listed in this data sheet but they can be supplied on request.

Male connectors with pre-centering do not mate with female connectors without a pre-centering recess.

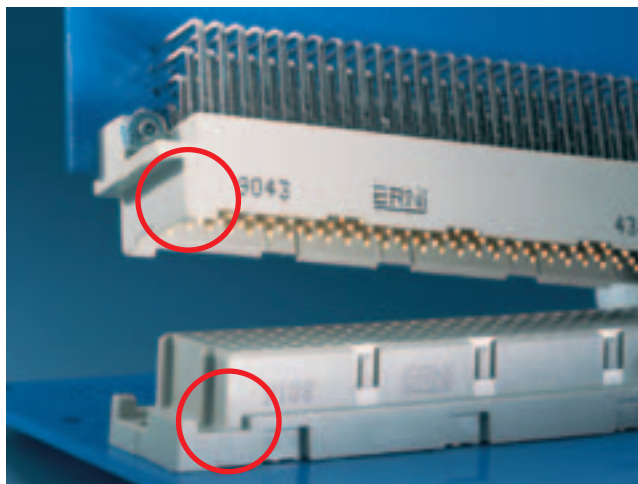

Codings

Various coding systems are available for the connectors contained in this data sheet.

- **Coding with coding strips.** These coding strips are mounted together with the connector. For ERNI coding strips no extra modular space is required in the 19" rack system.
- **Integrated coding with coding wedges.** In this case coding wedges are fitted into the female connectors and the male connectors are provided with corresponding recesses.
- **Integrated coding with coding pins.** In this case coding pins are inserted into the female connectors and holes are drilled in the male connectors in the coding positions.

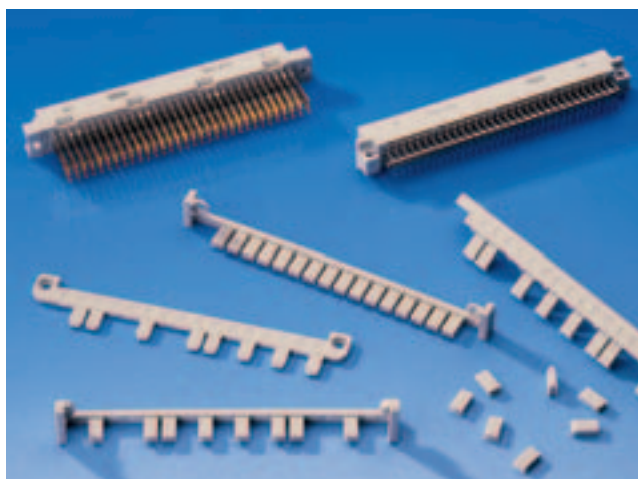

Retentive clip

For efficient mounting of the right angle connectors ERNI offers a retentive clip.

These clips are pre-mounted by ERNI. The connectors are attached to the pc board with this clip, which locks into the drillholes on the pc board, max. thickness of pcb = 1.6 mm. Since the clips can also be soldered, plated-through holes are recommended in such applications.



Wiring accessories

The ERNI connector housing range together with the ERNI interface connector system offers optimum protection for all plug-in interfaces for DIN 41612/IEC 60603-2 connectors. The range is dimensioned for the 19" rack system. Suitable variations are available for nearly every type of connector. Whether you intend to use a short type B/2 connector or a 64-pin insulation displacement connector, the ERNI range offers you the ideal housing.

- **KSG 173** Size: B, C, D, E, M, H11, H15, Q, R, E160, TE160, RD128
- **KSG 193** Size: B/2, C/2, Q/2, R/2
- **KSG 203** Size: F, Fi
- **KSG 253** Size: C (IDC)
- **KSG 204** Size: F, Fi

The connector housings are prepared for a maximum of 3 cable outlets and are offered with strain-relief clamps. A metal-plated version for shielding purposes is also available. For plug-in interfaces on the front or back panel of the rack ERNI has developed guide elements and shrouds in collaboration with well-known customers. These elements permit exact guidance for correct mating and provide robust screw locking. In addition you can fit a coding device.



Termination Technique

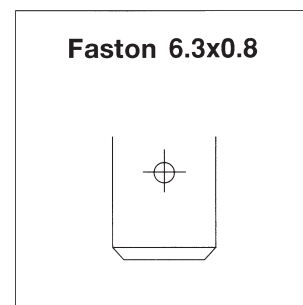
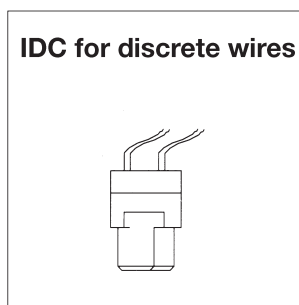
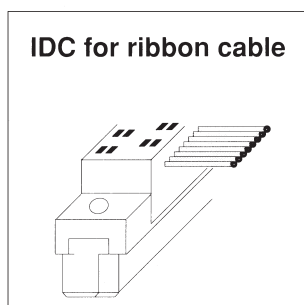
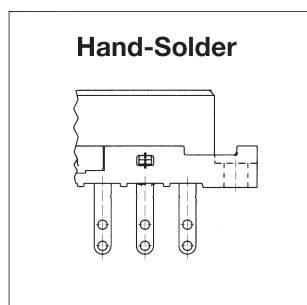
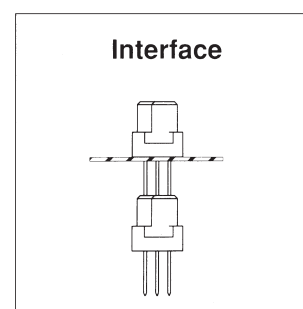
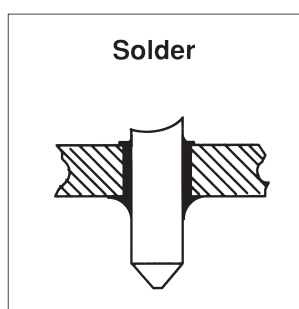
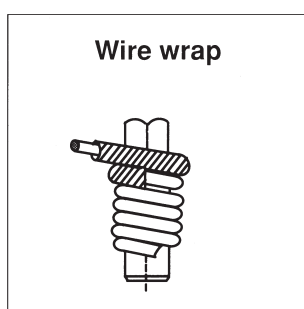
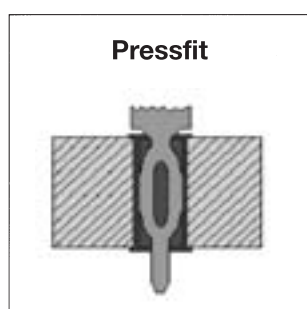

Basic dimensions for all sizes of the connector family according to DIN 41612/IEC 60603-2

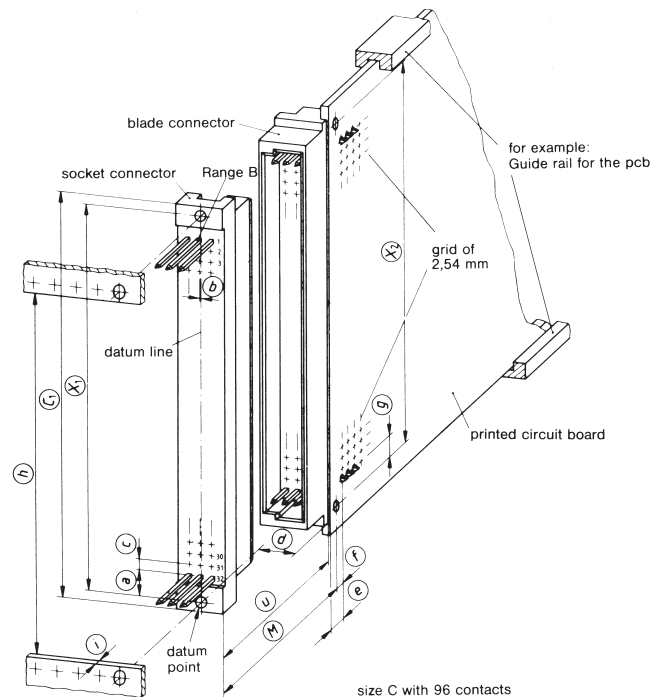

Important dimensions

Letter of dimension	Dimensions mm	Explanation
C ₁	95	Maximum length of the connector assigned to the back panel
M	15.5 to 17.3	Mating zone for reliable contact making
X ₁	90	Distance between the mounting holes of the connector assigned to the back panel
X ₂	88.9	Distance between the mounting holes of the connector assigned to the assembly
a	5.63	Distance between the reference point and centerline through contact no. 32 with regard to the connector assigned to the back panel
b	0.3	Distance between the reference line (line through the fixing holes) and centerline of row b (also called offset)
c	nx2.54	Pitch of the terminals of the connector assigned to the back panel)
d	3.55	Distance between the reference line and the component side of the PCB
e	5.3	Distance between the edge of the PCB and the first row of holes for terminals of the connector mounted on the assembly
f	2.54	Distance between the mounting holes and the first row of holes for terminals of the connector mounted on the assembly
g	5.08	Distance between the mounting holes and the holes for contacts no. 1 and no. 32 of the connector assigned to the assembly
h	85	Minimum length of the panel cutout or minimum distance between the mounting rails for the connector assigned to the back panel
i	2.5	Maximum thickness of mounting plate or mounting rails
u	12.4 to 14.2	Mating zone for reliable contact making

Mounting dimensions of the connectors

in the modular arrangement of the 19" rack system

Exact position of connectors **size C**

Exact position of connectors **size E**

Exact position of connectors **size F**

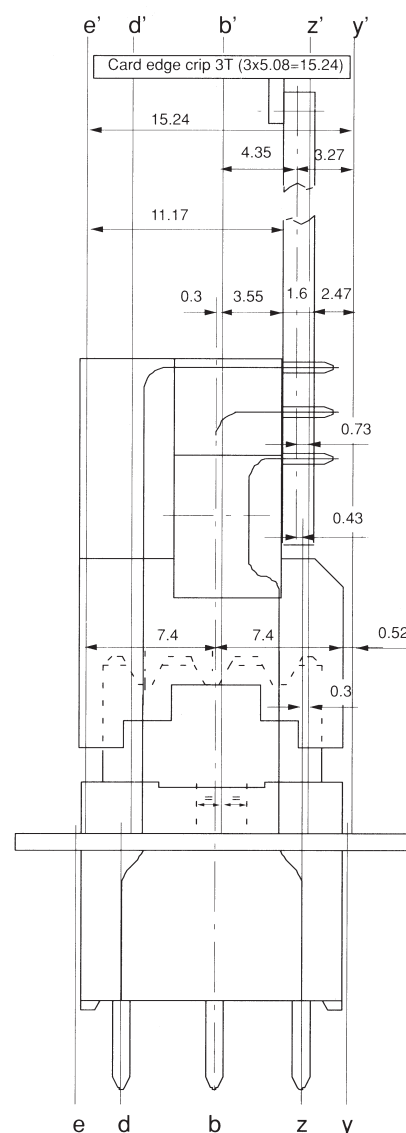
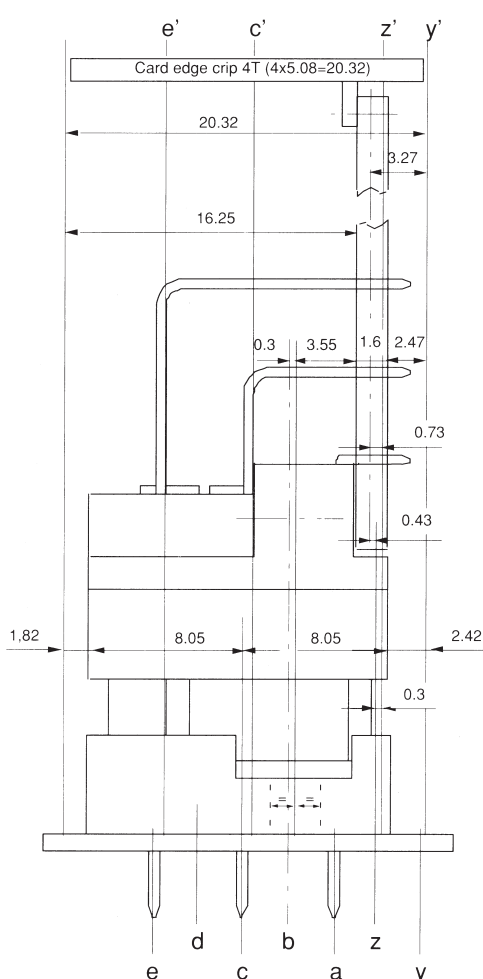
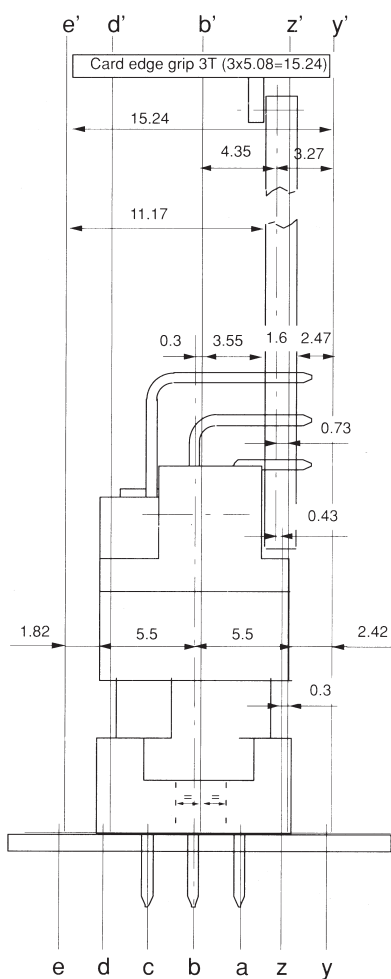

These drawings contain important dimensions for the use of DIN 41612/IEC 60603-2 connectors in 19" rack systems.

The mounting dimensions shown for size F connectors illustrate how the width of 3 x 5.08 mm is maintained by means of a pitch offset between mating side and soldering side. These size F connectors can be used with 3U wide daughter cards in a 3U (3x5.08) 19" slot.

Clearance and creepage distances

for DIN 41612/IEC 60603-2 male and female connectors

Two different clearance and creepage distances are always distinguished for connectors:

1. The distances a and b are the shortest clearance and creepage distance between assembly rail (chassis) and the closest terminal post.
2. The distances c and d are the shortest clearance and creepage distance between 2 adjacent terminal posts in unwrapped state.

All the values apply to the connectors prior to their termination to the printed circuit board. The influence of the wiring on the clearance creepage distance and must be taken into account.

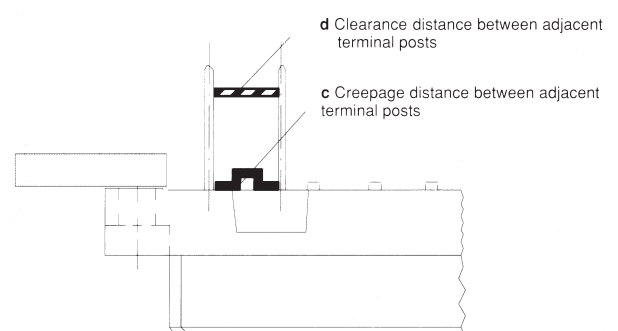
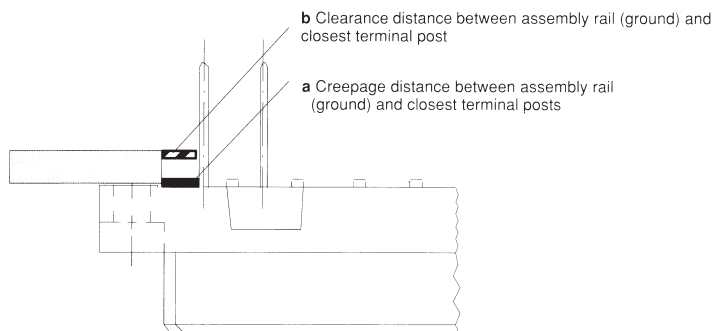

Minimum clearance and creepage distances according to IEC 60664

When calculating the minimum clearance and creepage distance for your application, the guidelines contained in IEC 60664 Parts 1 and 2, January 1989 issue are applicable. This standard contains the relevant values in tabular form.

Calculation of minimum **clearance** distances:

The minimum clearance primarily depends on the following factors:

- Rated impulse voltage for clearance distances (depending on overvoltage category).
- Pollution degree

Calculation of minimum **creepage** distance:

The minimum creepage distance is primarily dependent on the following factors:

- Operating voltage
- Pollution degree
- CTI values (comparative tracking index) of the insulation material
- Contents of insulation body

DIN 41612 / 60603-2 Pressfit Connectors ERNIPRESS™

In electronic and electrical equipment the solderless pressfit technique has become more and more widespread in times of packaging miniaturization and higher packing densities.

ERNI's compliant pressfit zone is a reliable connection between the PC Board and the connector.

ERNI offers a comprehensive pressfit range for all connector types. Also included in the ERNI pressfit range are the right angled pressfit connectors used for daughter card connectors. The pressfit zone is designed that the contact fit in the copper layer of the plated-through hole of a PCB. The tin plating of the hole is penetrated. The result is a reliable gas tight and therefore corrosion-free contact with low electrical resistance.

Solderless pressfit connectors are an integral part of today's modern electronic packaging bus systems. The main function of a bus system is to connect assemblies with one another and their power supply. Since plug-in modules are becoming more and more powerful, the demands placed on the bus systems are continually increasing. Higher system speeds and the overall shrinking of the connection structure are making the bus system a more crucial part of the control system.

With newer assembly processes for PC Boards, like the pressfit termination, the mechanism is now available to utilize more powerful electro mechanical components. ERNIPRESS™ solderless pressfit connectors are a perfect fit for such applications. Furthermore, there are many applications where the delicate structure of the PC Board cannot withstand the harshness of automated soldering processes.

For DIN connectors ERNI has two pressfit zones in use. Both zones require exactly the same hole specifications of the PCB.

1. EE-zone contour like a boat



2. EN-zone eye of the needle



Required specifications of the PCB

In manufacturing the PC Board for the pressfit technique it is essential that the recommended DIN PC Board specifications are met. The dimensions of the plated through drillholes and their hole design are described in IEC 60352-5.

The quality and long-term performance of a pressfit connector are influenced by the following factors:

- a) Base material of the PCB.
To meet UL requirements, epoxy glass fabric type Hgw 2372.1 to DIN 7735, FR 4, should be used.
- b.) Adherence to drillhole tolerances.
For optimum and uniform plating of the PCB, a selective rack technique, flexible anode arrangement and continuous plating bath monitoring are suggested.
- c.) Drillhole diameter, positioning and diameter tolerances.
Maintaining the correct roughness of the drillhole wall and restricting drill bit travel are critical production processes.
- d.) PCB hole and layout requirements.
A minimal residual ring width of 0.1 mm, finished hole diameter tolerances, layer thicknesses, and a high quality consistent conductive pattern are all critical.
- e.) Insertion and retention forces.
Measurement of these forces should be checked.

Insertion and retention forces

The design of the pressfit zone of the ERNIPRESS™ connectors performs a dual function. On the one hand this design has high elasticity and therefore can accommodate large hole tolerances. On the other hand, the pressfit zone's design ensures high edge loading at the copper layer of the PCB hole resulting in a gas-tight, corrosion-free and mechanically secure connection.

Due to the special shape of the pressfit zone, insertion forces are not detrimental to the hole plating.

Retention forces of the contacts in the PCB hole are sufficient to withstand the torques which occur during wire wrap termination. Typical average values for retention force are between 50 – 110 N per contact depending upon PCB thicknesses.

Hole design

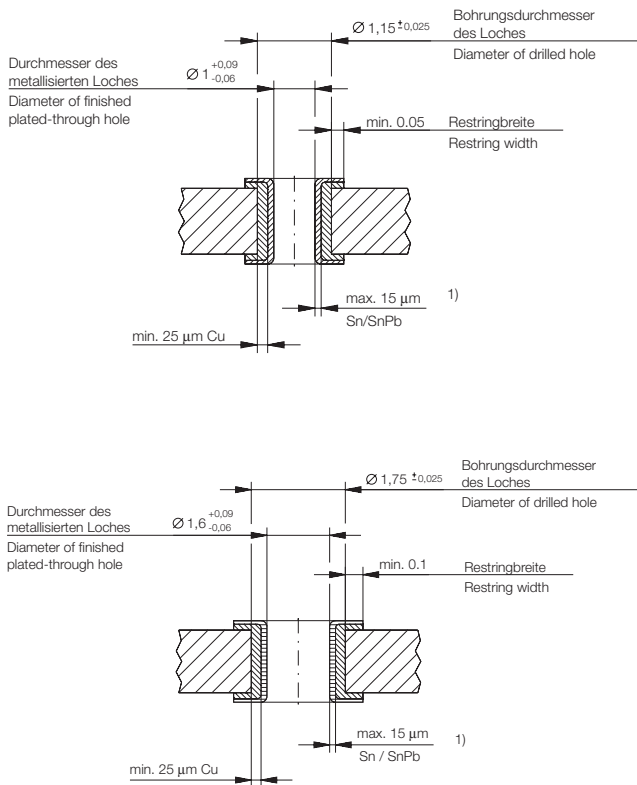

Press-in tools



Vertical Pressfit Connectors

The male and female connectors are assembled into the PC Board in a one-step operation. No additional securing such as with screw hardware is necessary.

Pressfitting of female connector sizes B, B/2, B/3, C, C/2, C/3, M, D, E and F is performed with the aid of a press-in tool which transmits the insertion force to the individual contacts.

For female connector sizes B and C, an additional version is offered which can be pressfitted with just a flat press-in tool. Insertion force is absorbed by the connector housing.

Female connector sizes E 160, H 11 and H 15 are similarly pressfitted with a flat press-in tool.

When pressfitting the inverted male connectors the insertion force is directly loaded on the male contacts.

Right Angle Pressfit Connectors

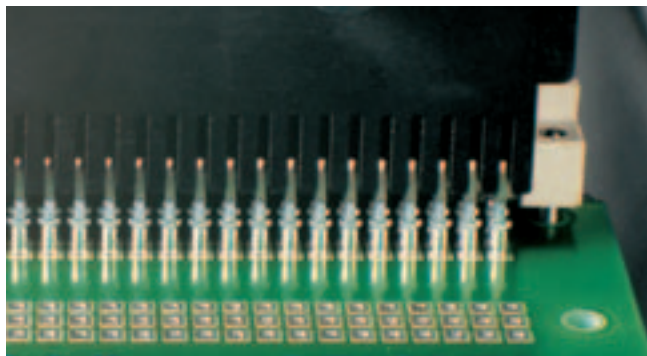

The male connectors and the inverted female connectors have right-angled pressfit terminations with a shoulder. The appropriate press-in tool with matching cavities, enables the pressfitting of the connectors into the PCB. The press-in forces are absorbed by the contact shoulder.

Ordering Information

Vertical Female Connectors Type	Contact Supporting Upper Tool Part Number	Flat Upper Tool Part Number	Lower Tool Part Number	Pin Cross Section
B		471787	220108	
B/2		220368	220051	
B/3		220369	220527	
C		471684	471855	
C/2		471791	220051	
C/3		220139	220527	
CD		471837	473447	
E160		471584	473447	
E80		471920	471677	
Eurocard Center Connectors	473449		471943	
D	471590	471684	471855	0.6x0.6
			471694	1x1
E	471591	471584	473447	0.6x0.6
			471694	1x1
F flat			473447	
F	471592	220153	471694	
M 6-10	220894		471867	
M 24-8	220892		471867	
M 42-6	220891		471867	
M 60-4	220890		471867	
M 78-2	220889		471867	
H 11		471684	473161	
H15		471836	471839	



Ordering Information

Vertical Male Connectors Type	Contact Supporting Upper Tool Part Number	Lower Tool Part Number
Q	220370	220108
R	220991	471855
R/2	471597	220051
R/3	220364	220527
RD	471606	473447
TE	471608	473447

Right Angle Male Connectors Type	Contact Supporting Upper Tool Part Number	Flat Upper Tool Part Number	Lower Tool Part Number
B	471630		471729
B/2	471632		471729
B/3	471634		471729
C	471629	220316	471556
C/2	471631		471556
C/3	471633		471556
CD	471922		471793
E160	471628		471710

Right Angle Female Connectors Type	Contact Supporting Upper Tool Part Number	Flat Upper Tool Part Number	Lower Tool Part Number
Q	471640		471729
R		on request	471556
R/2		220411	220681
R/3		230032	471556
RD	471638		471793
TE	471637		471710

Presses

In addition ERNI offers modern hand lever presses with different options. At least insertion forces can be measured and monitored by a IPC supported hand lever press.



	Standard	B, B/2, B/3, C, C/2, C/3, Q, Q/2, Q/3, R, R/2, R/3, CD, RD, TE, E80, E160, ECC	M
Number of Pins		20, 30, 32, 48, 64, 80, 96, 128, 160	6, 24, 42, 60, 78
Technical data			
Climate Category	DIN EN 60068-1 test b	55/125/56	55/125/56
Temperature range		-55/125 °C	-55/125 °C
Current rating	IEC60512 test 5b	Ambient temperature 20 °C 2.0 A 70 °C 1.6 A 100 °C 1.0 A	Ambient temperature 20 °C 2.0 A 70 °C 1.6 A 100 °C 1.0 A
Clearance and creepage distance		contact - contact 1.2 mm contact - ground 1.8 mm contact - ground 1.6 mm (clearance)	contact - contact 1.2 mm contact - ground 3.0 mm contact - ground 2.5 mm (clearance)
CTI value	IEC 60112	225 (Standard and THR) 250 (Inverted Versions)	225
Voltage rating	IEC 60664	Has to be determined according to customer application (degree of environmental pollution) according to IEC 60664	Has to be determined according to customer application (degree of environmental pollution) according to IEC 60664
Dielectric strength	IEC 60512	contact - contact 1000 V _{rms} contact - ground 1550 V _{rms}	contact - contact 1000 V _{rms} contact - ground 1550 V _{rms}
Contact resistance	IEC 60512 test 2a	< 20 mΩ	< 20 mΩ
Insulation resistance	IEC 60512 test 3a	> 10 ⁶ MΩ	> 10 ⁶ MΩ
Vibration sine	IEC 60512 test 6d	10 – 2000 Hz 20 g	10 – 2000 Hz 20 g
Contact interruption (while vibration test)	IEC 60512 test 2e	< 1 μs	< 1 μs
Shock halvesine	IEC 60512 test 6c	50 g 11 ms	50 g 11 ms
Contact interruption (while shock test)	IEC 60512 test 2e	< 1 μs	< 1 μs
Mechanical operation (mating cycles)	IEC 60512 test 9a	Class 1: 500 mating cycles Class 2: 400 mating cycles	Class 1: 500 mating cycles Class 2: 400 mating cycles
Insertion and withdrawal force	IEC 60512 test 13b	20 cont.: 18 N max. 30 cont.: 28 N max. 32 cont.: 30 N max. 48 cont.: 45 N max. 64 cont.: 60 N max. 96 cont.: 90 N max. 128 cont.: 100 N max. 160 cont.: 110 N max.	6 cont.: 5 N max. 24 cont.: 22 N max. 42 cont.: 40 N max. 60 cont.: 57 N max. 78 cont.: 74 N max. With special contacts max. 100 N
Gauge retention force per contact	IEC 60512 test 16e	> 0.15 N	> 0.15 N



	Standard	B, B/2, B/3, C, C/2, C/3, Q, Q/2, Q/3, R, R/2, R/3, CD, RD, TE, E80, E160, ECC	M
Number of Pins		20, 30, 32, 48, 64, 80, 96, 128, 160	6, 24, 42, 60, 78
Process-conditions			
Solder temperature max.	IEC 68-2-20		
Hand soldering temperature max.		3.5 s at 350 °C	3.5 s at 350 °C
Dip soldering temperature max.		10 s at 260 °C	10 s at 260 °C
Reflow soldering temperature max.		10 s at 260 °C (THR versions)	
Warning		Soldering of pressfit connectors not recommended.	Soldering of pressfit connectors not recommended.
Materials			
Housing: Plastic material (symbol)		PBT GF30 (Standard) PA 10T30GF (THR)	PBT GF30 (Standard)
CTI value	IEC 60112	250 (Standard) 600 (THR)	225
UL flame rating		UL 94 V-0	UL 94 V-0
UL file		E171666	E171666
Contact and mating area			
Base material		Cu alloy	Cu alloy
Plating		Gold plated	Gold plated
Termination area			
Base material		Cu alloy	Cu alloy
Solder, pressfit and THR		Sn	Sn
Environment compatibility			
Recycling		no flame-retardent additives, no toxic additives, allows easy recycling	
Product-approval and customer specific tests			
cUL		E84703	E84703

DIN 41612 / IEC 60603-2 Connectors

Electrical and Mechanical Characteristics



	Standard	D, E	F
Number of Pins		32, 48	32, 48
Technical data			
Climate Category	DIN EN 60068-1 test b	55/125/56	55/125/56
Temperature range		-55/125 °C	-55/125 °C
Current rating	IEC60512 test 5b	Ambient temperature 20 °C 5.5 A 70 °C 4.0 A 100 °C 2.5 A	Ambient temperature 20 °C 5.5 A 70 °C 4.0 A 100 °C 2.5 A
Clearance and creepage distance		contact - contact 3.0 mm (clearance) contact - ground 1.6 mm (clearance) contact - contact 3.0 mm contact - ground 1.8 mm	contact - contact 1.6 mm (clearance) contact - ground 3.5 mm (clearance) contact - contact 3.0 mm contact - ground 6.0 mm
CTI value	IEC 60112	225	175 (Type F) 250 (Type F flat)
Voltage rating	IEC 60664	Has to be determined according to customer application (degree of environmental pollution) according to IEC 60664	Has to be determined according to customer application (degree of environmental pollution) according to IEC 60664
Dielectric strength	IEC 60512	contact - contact 1550 V _{rms} contact - ground 1550 V _{rms}	contact - contact 1550 V _{rms} contact - ground 2500 V _{rms}
Contact resistance	IEC 60512 test 2a	< 15 mΩ	< 15 mΩ
Insulation resistance	IEC 60512 test 3a	> 10 ⁶ MΩ	> 10 ⁶ MΩ
Vibration sine	IEC 60512 test 6d	10 – 2000 Hz 20 g	10 – 2000 Hz 20 g
Contact interruption (while vibration test)	IEC 60512 test 2e	< 1 μs	< 1 μs
Shock halfsine	IEC 60512 test 6c	50 g 11 ms	50 g 11 ms
Contact interruption (while shock test)	IEC 60512 test 2e	< 1 μs	< 1 μs
Mechanical operation (mating cycles)	IEC 60512 test 9a	Class 1: 500 mating cycles Class 2: 400 mating cycles	Class 1: 500 mating cycles Class 2: 400 mating cycles
Insertion and withdrawal force	IEC 60512 test 13b	D: 40 N max. E: 60 N max.	32 cont.: 50 N max. 48 cont.: 75 N max.
Gauge retention force per contact	IEC 60512 test 16e	> 0.15 N	> 0.2 N

DIN 41612 / IEC 60603-2 Connectors

Electrical and Mechanical Characteristics



	Standard	D, E	F
Number of Pins		32, 48	32, 48
Process-conditions			
Solder temperature max.	IEC 68-2-20		
Hand soldering temperature max.		3.5 s at 350 °C	3.5 s at 350 °C
Dip soldering temperature max.		10 s at 260 °C	10 s at 260 °C
Warning		Soldering of pressfit connectors not recommended.	Soldering of pressfit connectors not recommended.
Materials			
Housing: Plastic material (symbol)		PBT GF	PC GF (Type F) PBT GF (Type F flat)
CTI value	IEC 60112	225	175 (Type F) 250 (Type F flat)
UL flame rating		UL 94 V-0	UL 94 V-1 (Type F) UL 94 V-0 (Type F flat)
UL file		E47960	E41613 (Type F) E41938 (Type F flat)
Contact and mating area			
Base material		Cu alloy	Cu alloy
Plating		Gold plated	Gold plated
Termination area			
Base material		Cu alloy	Cu alloy
Solder, pressfit and THR		Sn	Sn
Environment compatibility			
Recycling		no flame-retardent additives, no toxic additives, allows easy recycling	
Product-approval and customer specific tests			
cUL		E84703	E84703



	Standard	H11	H15, H-F (data only for Contacts)
Number of Pins		11	15, 7/24 (7 Power/24 Signal)
Technical data			
Climate Category	DIN EN 60068-1 test b	55/125/56	55/125/56
Temperature range		-55/125 °C	-55/125 °C
Current rating	IEC60512 test 5b	Ambient temperature 20 °C 15 A 70 °C 11 A 100 °C 7.5 A	Ambient temperature 20 °C 15 A 70 °C 11 A 100 °C 7.5 A
Clearance and creepage distance		contact - contact 4.5 mm (clearance) contact - ground 4.5 mm (clearance) contact - contact 8 mm contact - ground 8 mm	contact - contact 4.5 mm (clearance) contact - ground 4.5 mm (clearance) contact - contact 8 mm contact - ground 8 mm
CTI value	IEC 60112	175	175 225 (H11 solder, pressfit)
Voltage rating	IEC 60664	Has to be determined according to customer application (degree of environmental pollution) according to IEC 60664	Has to be determined according to customer application (degree of environmental pollution) according to IEC 60664
Dielectric strength	IEC 60512	contact - contact 3100 V _{rms} contact - ground 3100 V _{rms}	contact - contact 3100 V _{rms} contact - ground 3100 V _{rms}
Contact resistance	IEC 60512 test 2a	< 8 mΩ	< 8 mΩ
Insulation resistance	IEC 60512 test 3a	> 10 ⁶ MΩ	> 10 ⁶ MΩ
Vibration sine	IEC 60512 test 6d	10 – 2000 Hz 20 g	10 – 2000 Hz 20 g
Contact interruption (while vibration test)	IEC 60512 test 2e	< 1 μs	< 1 μs
Shock halfsine	IEC 60512 test 6c	50 g 11 ms	50 g 11 ms
Contact interruption (while shock test)	IEC 60512 test 2e	< 1 μs	< 1 μs
Mechanical operation (mating cycles)	IEC 60512 test 9a	Class 1: 500 mating cycles	Class 1: 500 mating cycles
Insertion and withdrawal force	IEC 60512 test 13b	max. 80 N	max. 90 N
Gauge retention force per contact	IEC 60512 test 16e	> 0.2 N	> 0.2 N

DIN 41612 / IEC 60603-2 Connectors

Electrical and Mechanical Characteristics



	Standard	H11	H15, H-F (data only for Contacts)
Number of Pins		11	15, 7/24 (7 Power/24 Signal)
Process-conditions			
Solder temperature max.	IEC 68-2-20		
Hand soldering temperature max.		3.5 s at 350 °C	3.5 s at 350 °C
Dip soldering temperature max.		10 s at 260 °C	10 s at 260 °C
Warning		Soldering of pressfit connectors not recommended.	Soldering of pressfit connectors not recommended.
Materials			
Housing:		PC GF	PC GF
Plastic material (symbol)		LCP GF (Female Pressfit)	PBT GF (H11 solder, pressfit)
CTI value	IEC 60112	175	175 225 (H11 solder, pressfit)
UL flame rating		UL 94 V-1 UL 94 V-0 (Female Pressfit)	UL 94 V-1 UL 94 V-0 (H11 solder, pressfit)
UL file		E41613 E83005	E41613 E47960 (H11 solder, pressfit)
Contact and mating area			
Base material		Cu alloy	Cu alloy
Plating		Silver plated	Silver plated
Termination area			
Base material		Cu alloy	Cu alloy
Plating		Sn	Sn
Environment compatibility			
Recycling		no flame-retardent additives, no toxic additives, allows easy recycling	
Product-approval and customer specific tests			
cUL		E84703	E84703



	Standard	IDC	Crimp
Number of Pins		64, 96	48, 96, 160
Technical data			
Climate Category	DIN EN 60068-1 test b	55/125/56	55/125/56
Temperature range		-55/125 °C	-55/125 °C
Current rating	IEC60512 test 5b	Ambient temperature 20 °C 2.0 A 70 °C 1.6 A 100 °C 1.0 A	Ambient temperature 20 °C 2.0 A 70 °C 1.6 A 100 °C 1.0 A
Clearance and creepage distance		contact - contact 1.2 mm contact - ground 1.8 mm contact - ground 1.6 mm (clearance)	contact - contact 1.2 mm contact - ground 1.8 mm contact - ground 1.6 mm (clearance)
CTI value	IEC 60112	175 (Type C 96) 225	225 (Type C/2) 250
Voltage rating	IEC 60664	Has to be determined according to customer application (degree of environmental pollution) according to IEC 60664	Has to be determined according to customer application (degree of environmental pollution) according to IEC 60664
Dielectric strength	IEC 60512	contact - contact 1000 V _{rms} contact - ground 1550 V _{rms}	contact - contact 1000 V _{rms} contact - ground 1550 V _{rms}
Contact resistance	IEC 60512 test 2a	< 20 mΩ	< 20 mΩ
Insulation resistance	IEC 60512 test 3a	> 10 ⁶ MΩ	> 10 ⁶ MΩ
Vibration sine	IEC 60512 test 6d	10 – 2000 Hz 20 g	10 – 2000 Hz 20 g
Contact interruption (while vibration test)	IEC 60512 test 2e	< 1 μs	< 1 μs
Shock halvesine	IEC 60512 test 6c	50 g 11 ms	50 g 11 ms
Contact interruption (while shock test)	IEC 60512 test 2e	< 1 μs	< 1 μs
Mechanical operation (mating cycles)	IEC 60512 test 9a	Class 1: 500 mating cycles Class 2: 400 mating cycles	Class 1: 500 mating cycles Class 2: 400 mating cycles
Insertion and withdrawal force	IEC 60512 test 13b	64 cont.: 60 N max. 96 cont.: 90 N max.	48 cont.: 45 N max. 96 cont.: 90 N max. 160 cont.: 110 N max.
Gauge retention force per contact	IEC 60512 test 16e	> 0.15 N	> 0.15 N

Attention

The electrical and thermal variables may be influenced by whichever cable is used.

DIN 41612 / IEC 60603-2 Connectors

Electrical and Mechanical Characteristics



	Standard	IDC	Crimp
Number of Pins		64, 96	48, 96, 160
Process-conditions			
Processing temperature		0/55 °C	0/55 °C
Materials			
Housing: Plastic material (symbol)		PC GF (Type C 96) PBT GF	PBT GF
CTI value	IEC 60112	175 (Type C 96) 225	225 (Type C/2) 250
UL flame rating		UL 94 V-1 (Type C 96) UL 94 V-0	UL 94 V-0
UL file		E41613 (Type C 96) E47960	E47960 (Type C/2) E41938
Contact and mating area			
Base material		Cu alloy	Cu alloy
Plating		Gold plated	Gold plated
Termination area			
Base material		Cu alloy	Cu alloy
Plating		Sn	Sn
Environment compatibility			
Recycling		no flame-retardent additives, no toxic additives, allows easy recycling	
Product-approval and customer specific tests			
cUL		E84703	
Attention			
The electrical and thermal variables may be influenced by whichever cable is used.			

DIN 41612 / IEC 60603-2 Connectors

Type B Male



Dimensional Drawing Solder

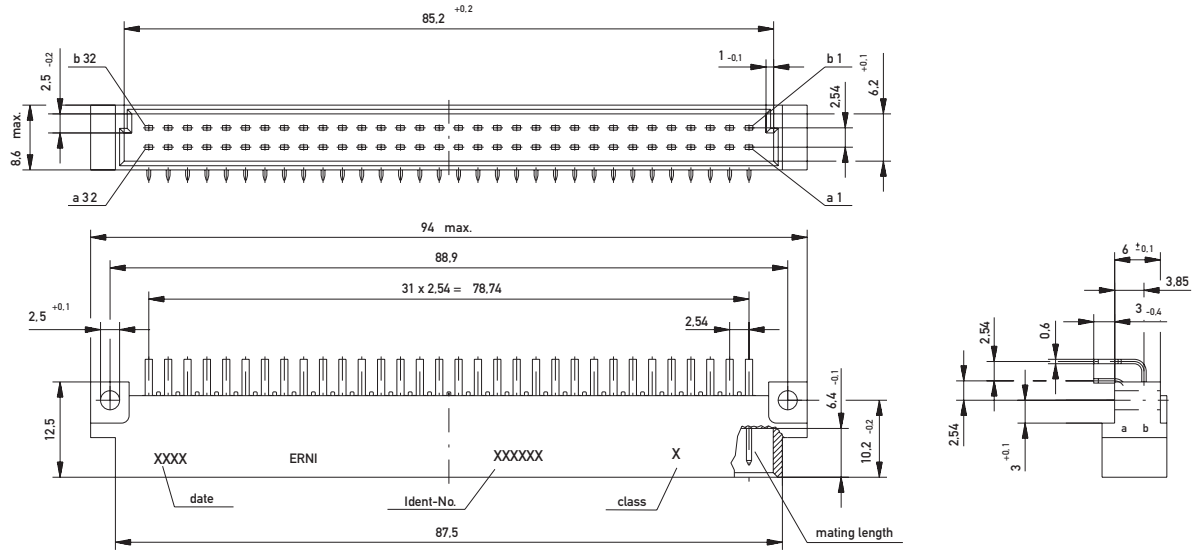

PCB drillhole pattern

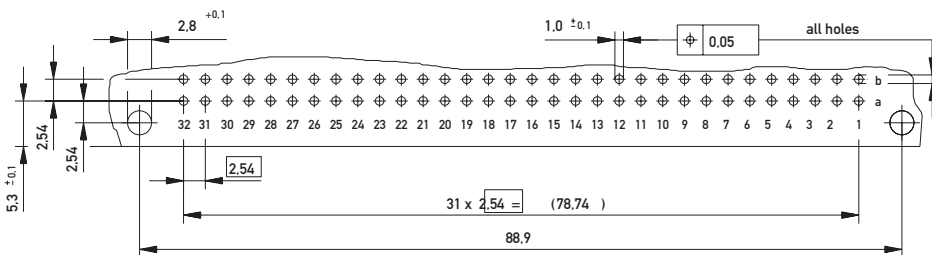

DIN 41612 / IEC 60603-2 Connectors

Type B Male

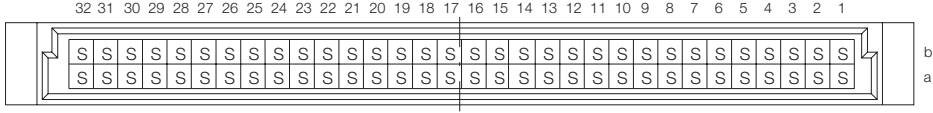
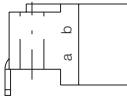
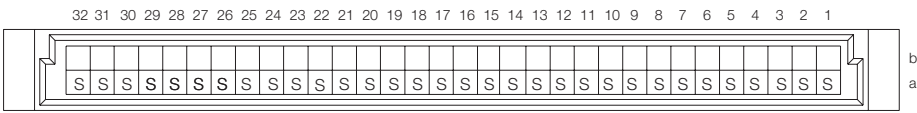
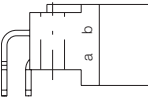
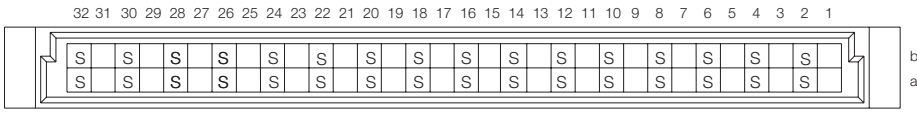
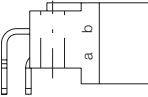
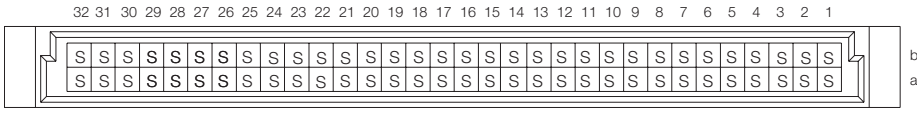

Ordering Information

No. of Pins	Termination	Term. Length	Pin Dimensions	Class	Pressfit Zone	Part Number
						
	64	Pressfit	3 mm	0.6 x 0.6 mm	2	1.5 mm
						
	32	Solder	3 mm	0.6 x 0.6 mm	1	–
32	Solder	3 mm	0.6 x 0.6 mm	2	–	533408
32	Solder with Clip	3 mm	0.6 x 0.6 mm	2	–	043606
						
	32	Solder	3 mm	0.6 x 0.6 mm	1	–
32	Solder	3 mm	0.6 x 0.6 mm	2	–	533407
						
	64	Solder	3 mm	0.6 x 0.6 mm	1	–
64	Solder	3 mm	0.6 x 0.6 mm	2	–	533406
64	Solder with Clip	3 mm	0.6 x 0.6 mm	2	–	023545

DIN 41612 / IEC 60603-2 Connectors

Type B Male



Ordering Information

No. of Pins	Termination	Term. Length	Pin Dimensions	Class	Pressfit Zone	Part Number
64	Solder	3.8 mm	0.6 x 0.6 mm	1	–	414377
64	Solder	3.8 mm	0.6 x 0.6 mm	2	–	414378
64	Solder	12 mm	0.6 x 0.6 mm	1	–	414379
64	Solder	12 mm	0.6 x 0.6 mm	2	–	414380

DIN 41612 / IEC 60603-2 Connectors

Type B/2 Male



Dimensional Drawing Pressfit

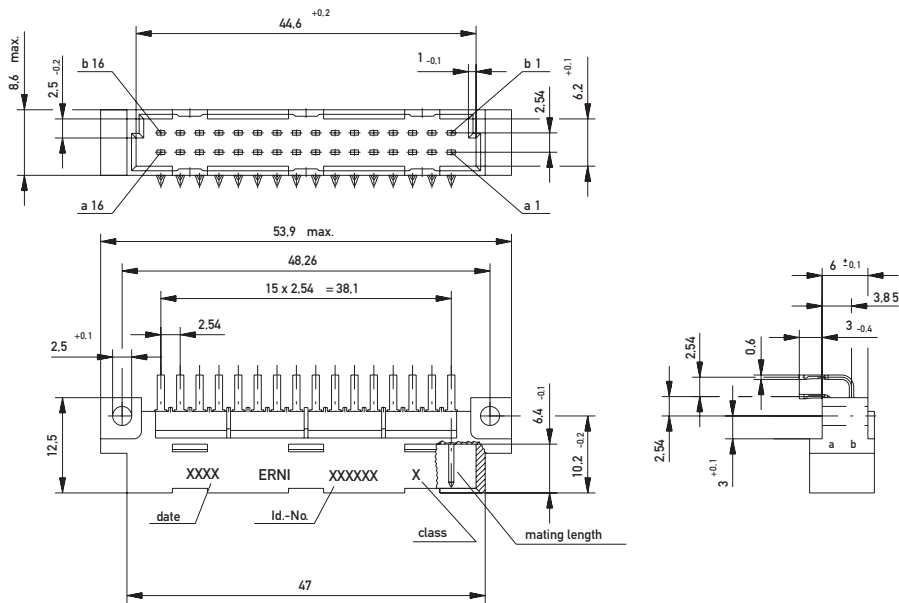

PCB drillhole pattern

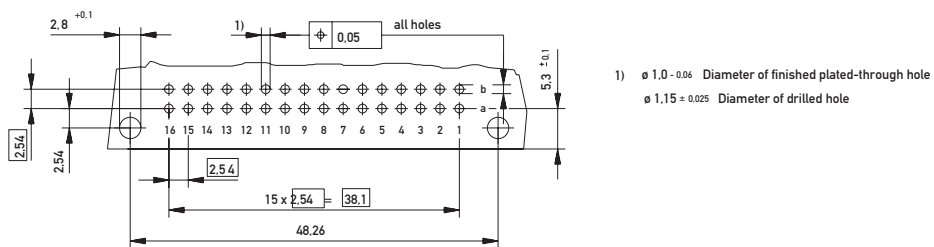

DIN 41612 / IEC 60603-2 Connectors

Type B/2 Male



Dimensional Drawing Solder

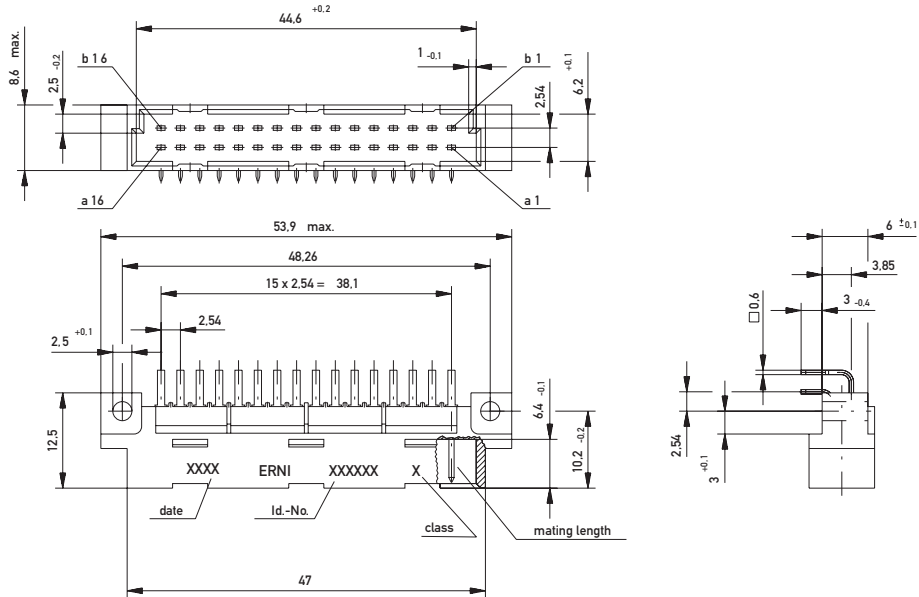

PCB drillhole pattern

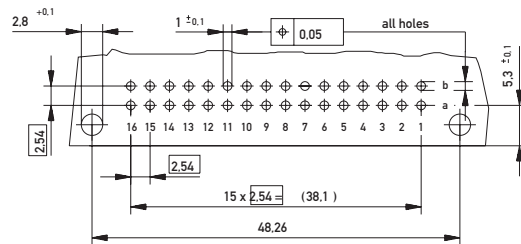





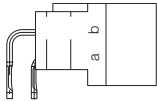
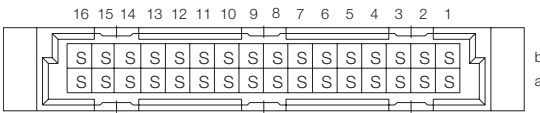
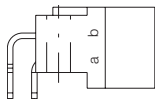
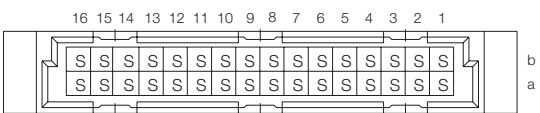

DIN 41612 / IEC 60603-2 Connectors

Type B/2 Male

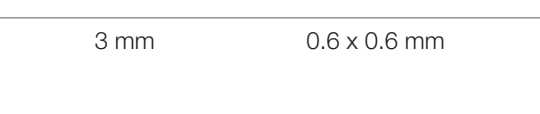
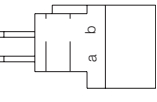
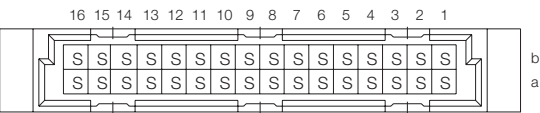

Ordering Information

No. of Pins	Termination	Term. Length	Pin Dimensions	Class	Pressfit Zone	Part Number
 	Pressfit	3 mm	0.6 x 0.6 mm	2	1.5 mm	013135
 	Solder	3 mm	0.6 x 0.6 mm	1	–	413852
 	Solder	3 mm	0.6 x 0.6 mm	2	–	413853
 	Solder	3.8 mm	0.6 x 0.6 mm	1	–	594056
 	Solder	3.8 mm	0.6 x 0.6 mm	2	–	594613
 	Solder	12 mm	0.6 x 0.6 mm	2	–	594614

DIN 41612 / IEC 60603-2 Connectors

Type B/3 Male



Dimensional Drawing Pressfit

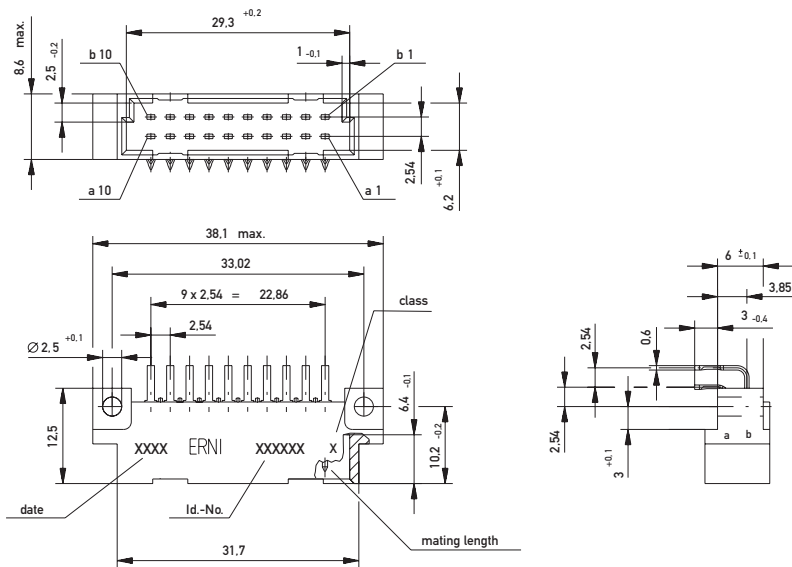

PCB drillhole pattern

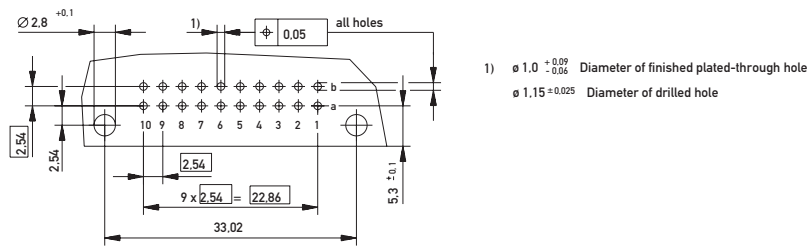

DIN 41612 / IEC 60603-2 Connectors

Type B/3 Male



Dimensional Drawing Solder

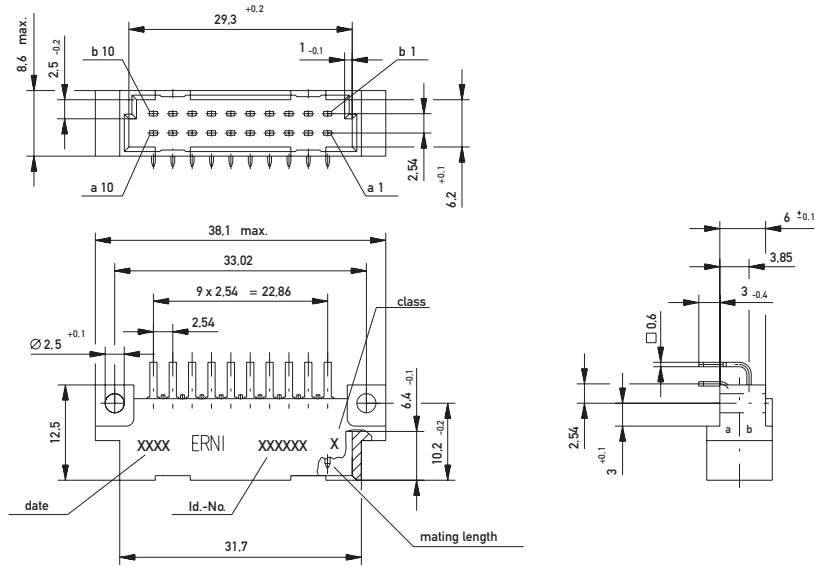

PCB drillhole pattern

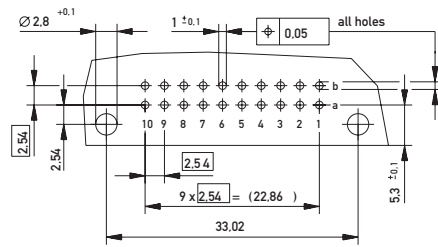

DIN 41612 / IEC 60603-2 Connectors

Type B/3 Male

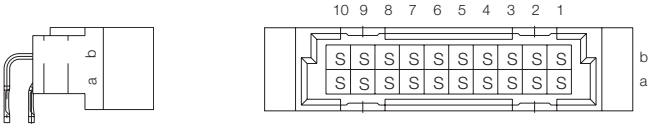
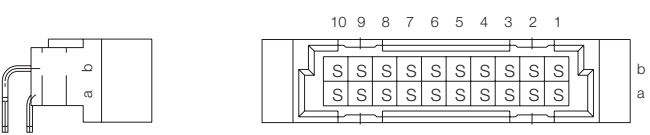

Ordering Information

No. of Pins	Termination	Term. Length	Pin Dimensions	Class	Pressfit Zone	Part Number
	Pressfit	3 mm	0.6 x 0.6 mm	2	1.5 mm	013133
	Solder	3 mm	0.6 x 0.6 mm	2	–	424207

DIN 41612 / IEC 60603-2 Connectors

Type B Female

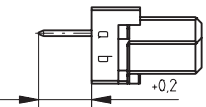
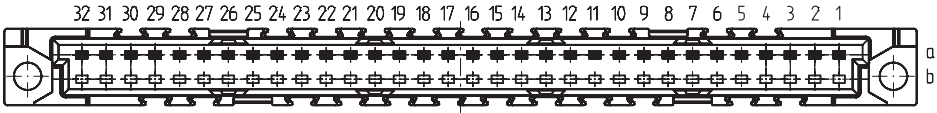
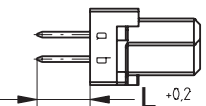
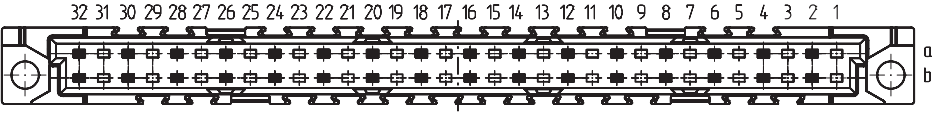
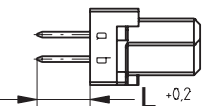
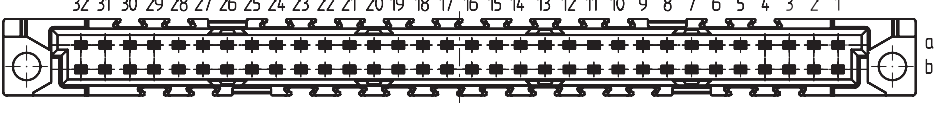

Ordering Information

No. of Pins	Termination	Term. Length	Pin Dimensions	Class	Pressfit Zone	Part Number
 	Pressfit	5.5 mm	0.6 x 0.6 mm	2	2.5 mm	254848
 	Pressfit	5.5 mm	0.6 x 0.6 mm	2	2.5 mm	254847
 	Pressfit	5.5 mm	0.6 x 0.6 mm	2	2.5 mm	254846
64	Pressfit	5.5 mm	0.6 x 0.6 mm	1	2.5 mm	284178
64	Pressfit w/o Flange	5.5 mm	0.6 x 0.6 mm	2	2.5 mm	254878
64	Pressfit w. Transfer Zone	13 mm	0.6 x 0.6 mm	2	3 mm	254976
64	Pressfit	17 mm	0.6 x 0.6 mm	2	2.5 mm	284177
64	Pressfit w. Transfer Zone	17 mm	0.6 x 0.6 mm	2	2.5 mm	284179

DIN 41612 / IEC 60603-2 Connectors

Type B Female

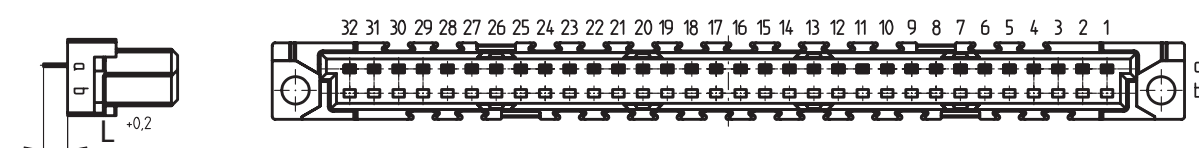

Ordering Information

No. of Pins	Termination	Term. Length	Pin Dimensions	Class	Pressfit Zone	Part Number
						
32	Solder	2.5 mm	0.65 x 0.3 mm	2	–	284873
32	Solder	4 mm	0.65 x 0.3 mm	1	–	284874
32	Solder	4 mm	0.65 x 0.3 mm	2	–	284651
32	Solder	13 mm	0.6 x 0.6 mm	1	–	284870
32	Solder	13 mm	0.6 x 0.6 mm	2	–	284871

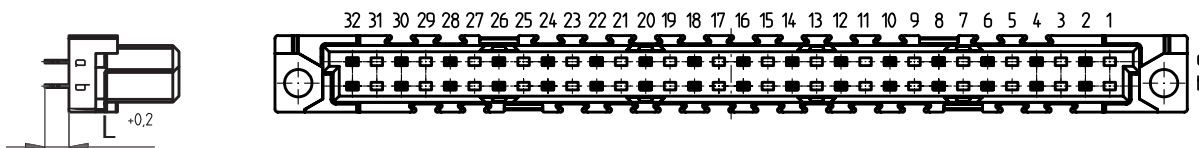
						
32	Solder	2.5 mm	0.65 x 0.3 mm	2	–	284875
32	Solder	4 mm	0.65 x 0.3 mm	2	–	284164
32	Solder	13 mm	0.6 x 0.6 mm	1	–	294694

DIN 41612 / IEC 60603-2 Connectors

Type B Female

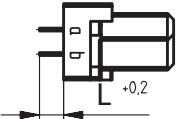
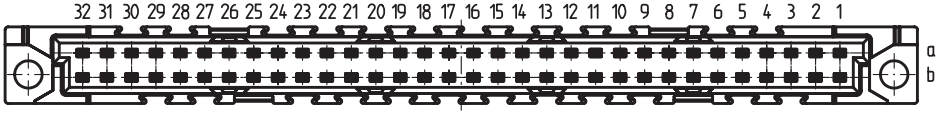

Ordering Information

No. of Pins	Termination	Term. Length	Pin Dimensions	Class	Pressfit Zone	Part Number
						
						
64	Solder	2.5 mm	0.65 x 0.3 mm	1	–	284883
64	Solder	2.5 mm	0.65 x 0.3 mm	2	–	284650
64	Solder with Clip	2.5 mm	0.65 x 0.3 mm	2	–	284882
64	Solder	4 mm	0.65 x 0.3 mm	1	–	284881
64	Solder	4 mm	0.65 x 0.3 mm	2	–	284166
64	Solder with Clip	4 mm	0.65 x 0.3 mm	2	–	284880
64	Solder	13 mm	0.6 x 0.6 mm	1	–	284876
64	Solder	13 mm	0.6 x 0.6 mm	2	–	284165
64	Solder w. Transfer Zone	17 mm	0.6 x 0.6 mm	2	–	284878
64	Solder w. Transfer Zone	13 mm	0.6 x 0.6 mm	2	–	284877

DIN 41612 / IEC 60603-2 Connectors

Type B/2 Female



Dimensional Drawing Solder

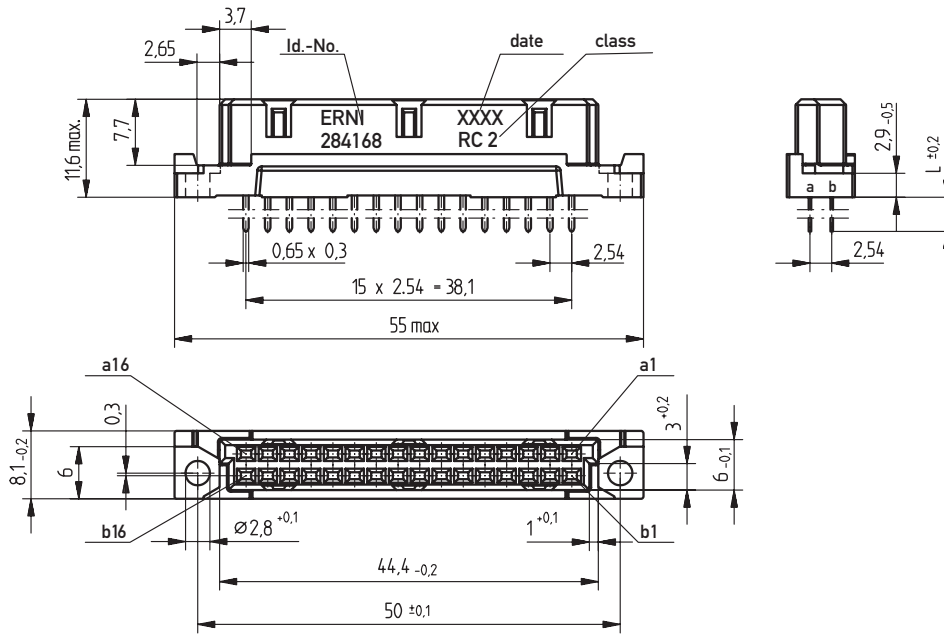

PCB drillhole pattern

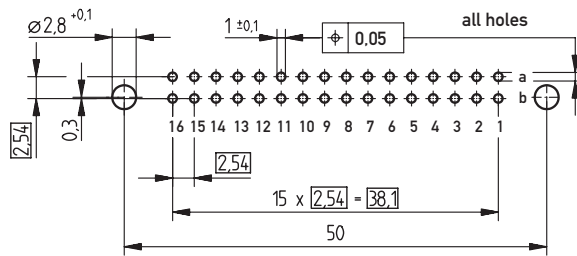

DIN 41612 / IEC 60603-2 Connectors

Type B/2 Female



Ordering Information

No. of Pins	Termination	Term. Length	Pin Dimensions	Class	Pressfit Zone	Part Number
32	Pressfit	5.5 mm	0.6 x 0.6 mm	2	3 mm	284891
32	Pressfit w. Transfer Zone	13 mm	0.6 x 0.6 mm	2	3 mm	284319
32	Pressfit w. Transfer Zone	17 mm	0.6 x 0.6 mm	2	3 mm	284895
32	Solder	2.5 mm	0.65 x 0.3 mm	2	–	284886
32	Solder	4 mm	0.65 x 0.3 mm	1	–	284888
32	Solder	4 mm	0.65 x 0.3 mm	2	–	284168
32	Solder	13 mm	0.6 x 0.6 mm	1	–	284889
32	Solder	13 mm	0.6 x 0.6 mm	2	–	284167

DIN 41612 / IEC 60603-2 Connectors

Type B/3 Female



Dimensional Drawing Pressfit

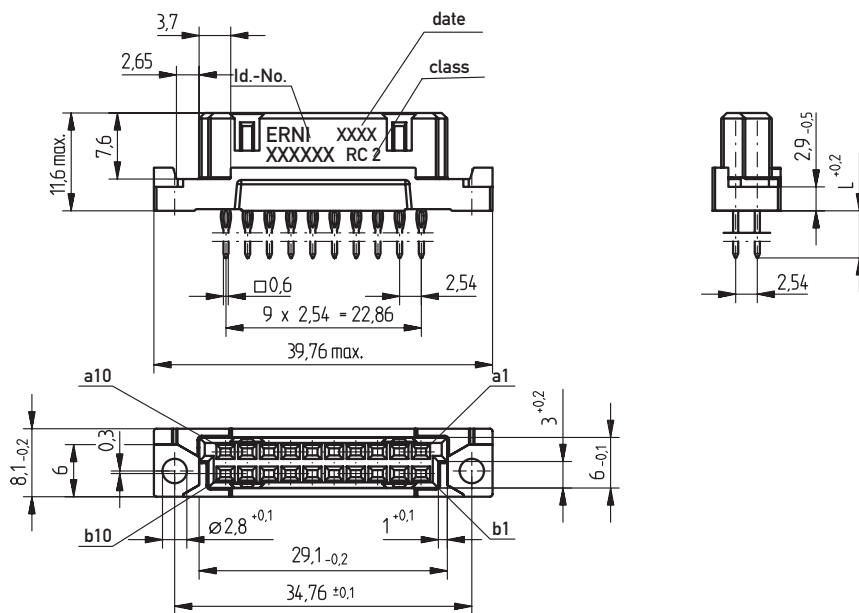

PCB drillhole pattern

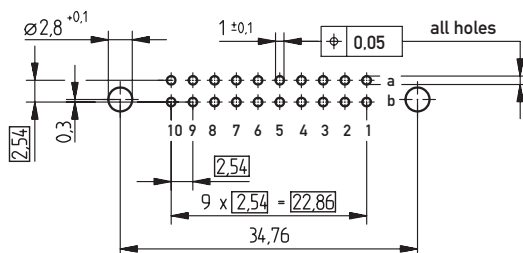

- 1) $\phi 1.0 \pm 0.06$ Diameter of finished plated-through hole
 $\phi 1.15 \pm 0.025$ Diameter of drilled hole

DIN 41612 / IEC 60603-2 Connectors

Type B/3 Female



Dimensional Drawing Solder

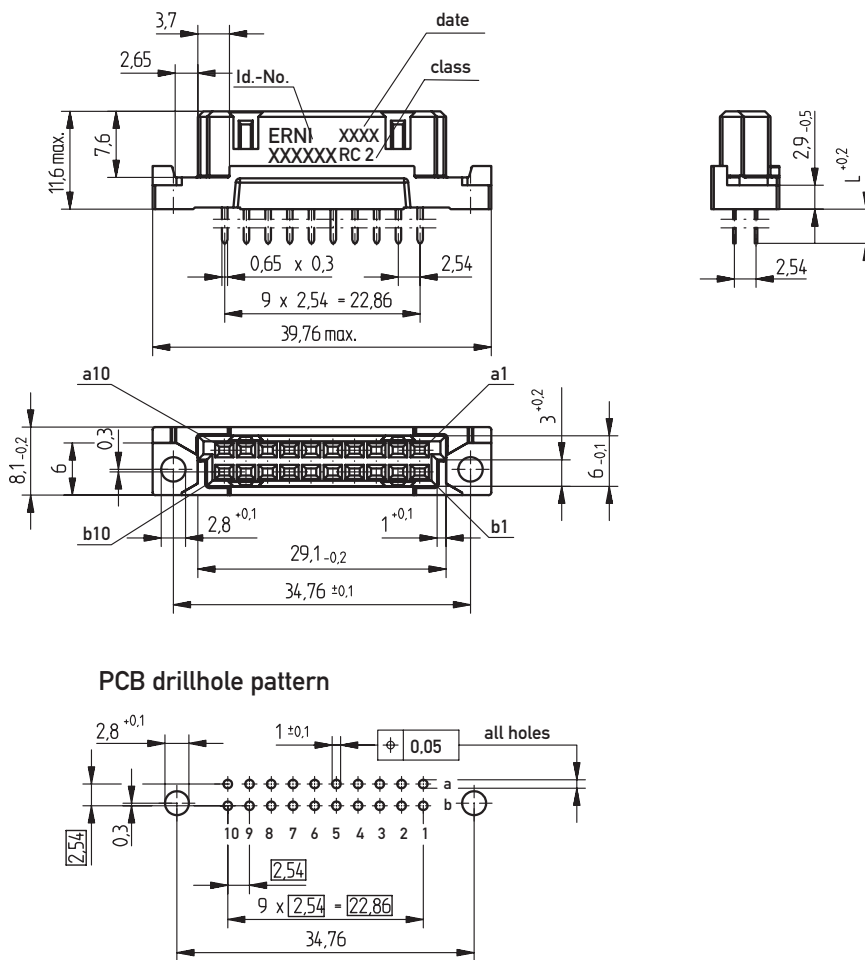

DIN 41612 / IEC 60603-2 Connectors

Type B/3 Female



Ordering Information

No. of Pins	Termination	Term. Length	Pin Dimensions	Class	Pressfit Zone	Part Number
20	Pressfit	5.5 mm	0.6 x 0.6 mm	2	3 mm	284418
20	Pressfit	17 mm	0.6 x 0.6 mm	2	3 mm	284896
20	Solder	4 mm	0.65 x 0.3 mm	2	–	254370
20	Solder	13 mm	0.6 x 0.6 mm	2	–	284169

DIN 41612 / IEC 60603-2 Connectors

Type Q Male



Dimensional Drawing Pressfit Type Q

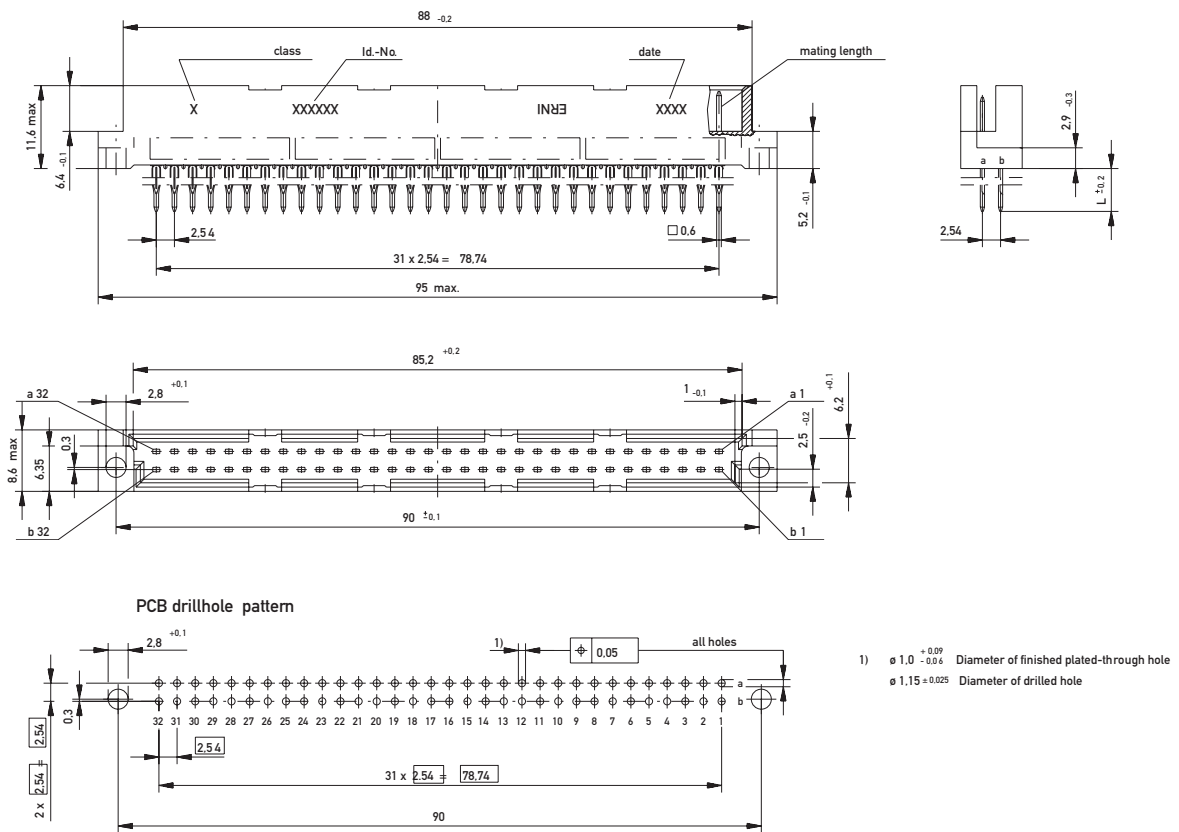

DIN 41612 / IEC 60603-2 Connectors

Type Q Male



Dimensional Drawing Solder Type Q

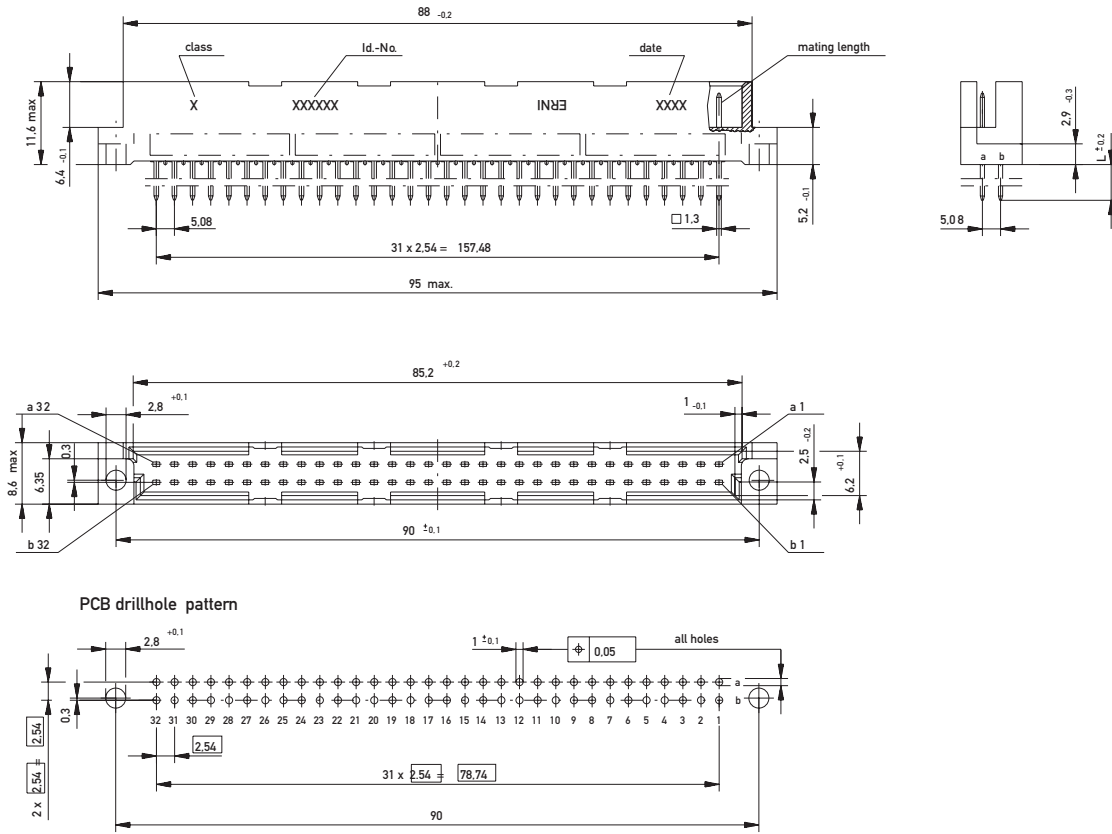

DIN 41612 / IEC 60603-2 Connectors

Type Q Male



Dimensional Drawing Solder Type Q/2

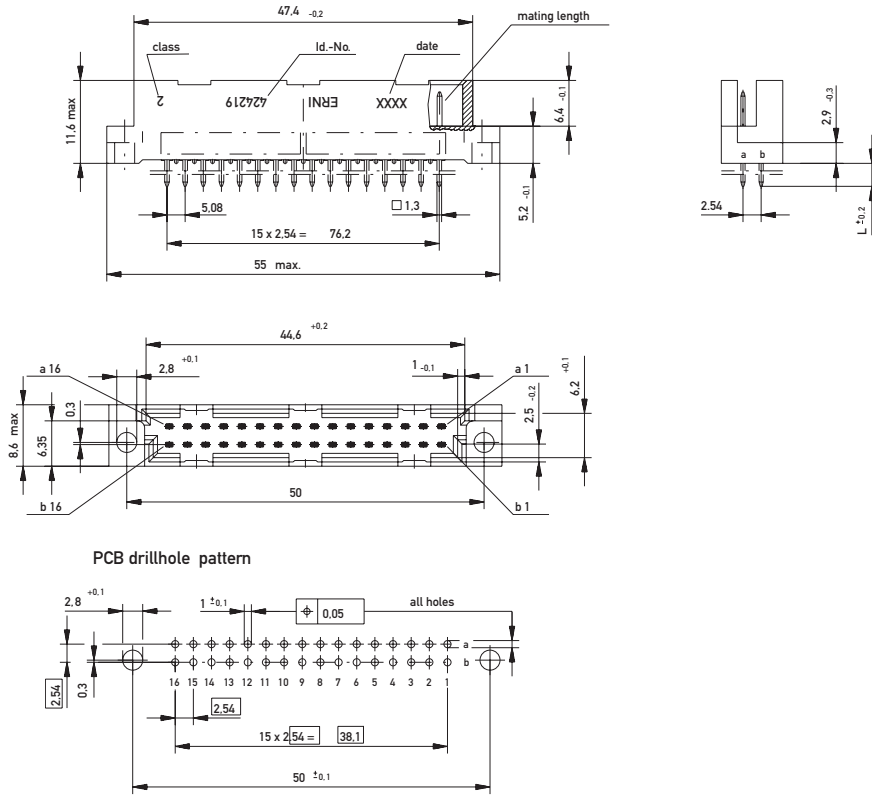

Dimensional Drawing Solder Type Q/3

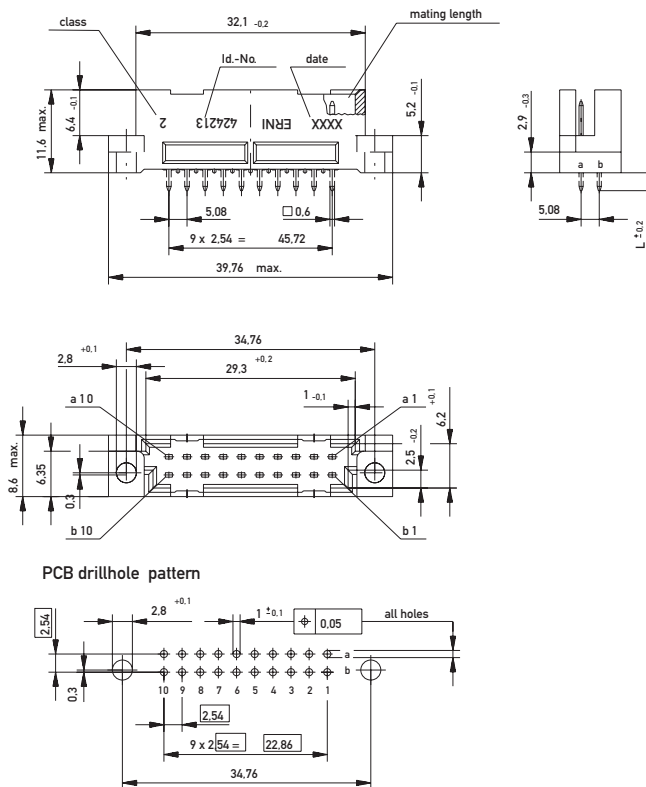

Ordering Information

No. of Pins Termination Term. Length Pin Dimensions Class Pressfit Zone Part Number

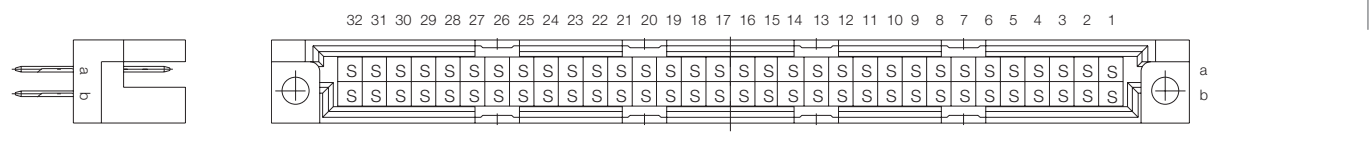

64	Pressfit	6 mm	0.6 x 0.6 mm	2	2.5 mm	593952
64	Pressfit w. Transfer Zone	20 mm	0.6 x 0.6 mm	2	2.5 mm	593964

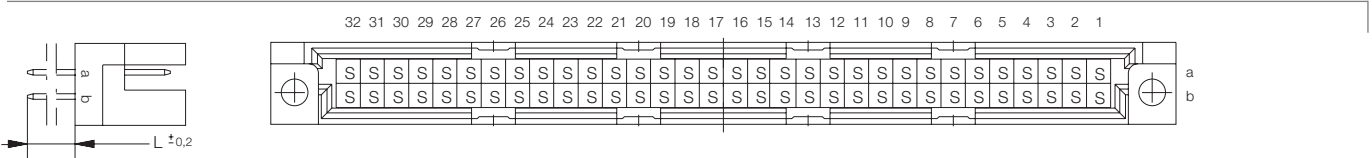

64	Solder	4 mm	0.6 x 0.6 mm	1	–	593933
64	Solder	4 mm	0.6 x 0.6 mm	2	–	593934
64	Solder	13 mm	0.6 x 0.6 mm	1	–	593927
64	Solder	13 mm	0.6 x 0.6 mm	2	–	593928

Type Q/2

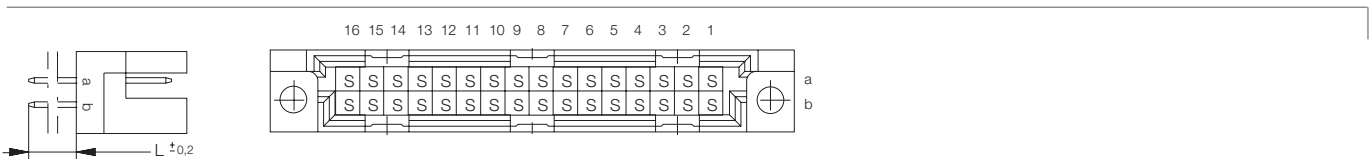

32	Solder	4 mm	0.6 x 0.6 mm	2	–	004483
32	Solder	13 mm	0.6 x 0.6 mm	2	–	424219

Type Q/3

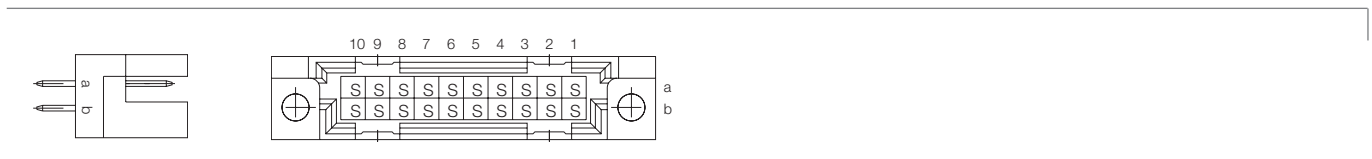

20	Solder	4 mm	0.6 x 0.6 mm	2	–	004498
20	Solder	13 mm	0.6 x 0.6 mm	2	–	424213

DIN 41612 / IEC 60603-2 Connectors

Type Q Female



Dimensional Drawing Pressfit Type Q

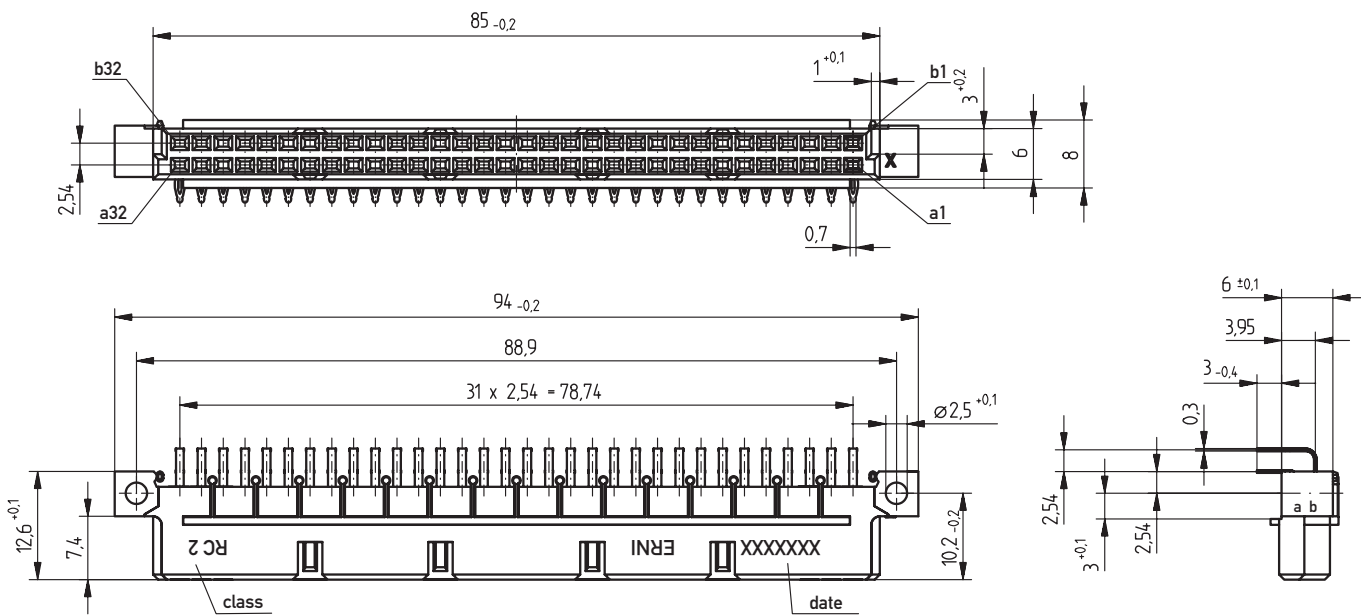

PCB drillhole pattern

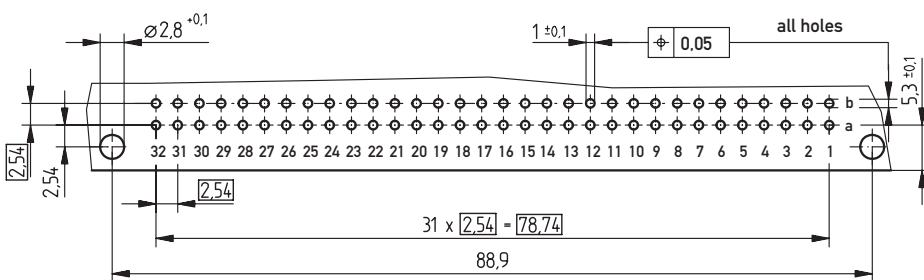

- 1) $\phi 1.0^{+0.007}$ Diameter of finished plated-through hole
- $\phi 1.15^{+0.025}$ Diameter of drilled hole

DIN 41612 / IEC 60603-2 Connectors

Type Q Female



Dimensional Drawing Solder Type Q

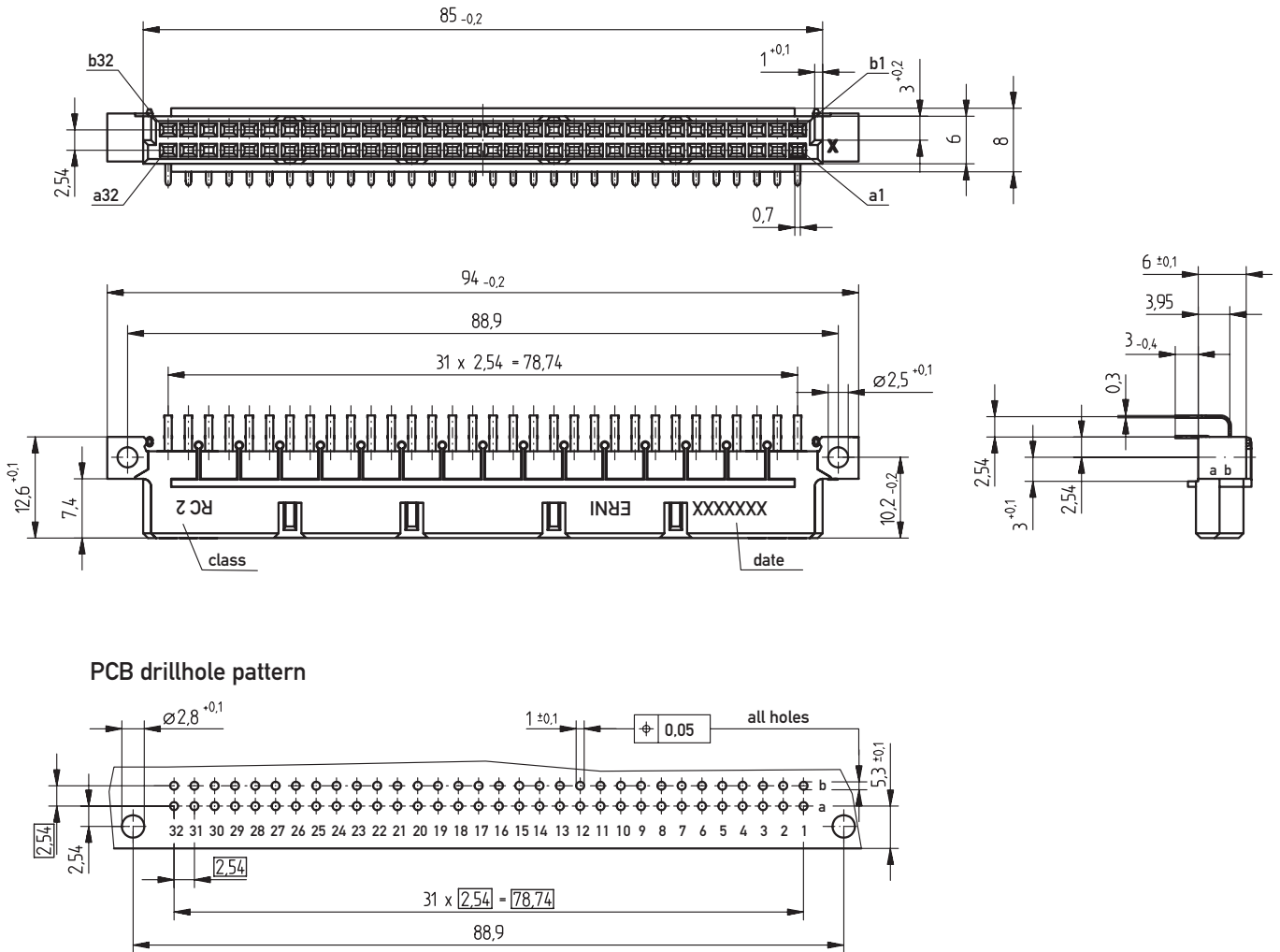



Dimensional Drawing Solder Type Q/2

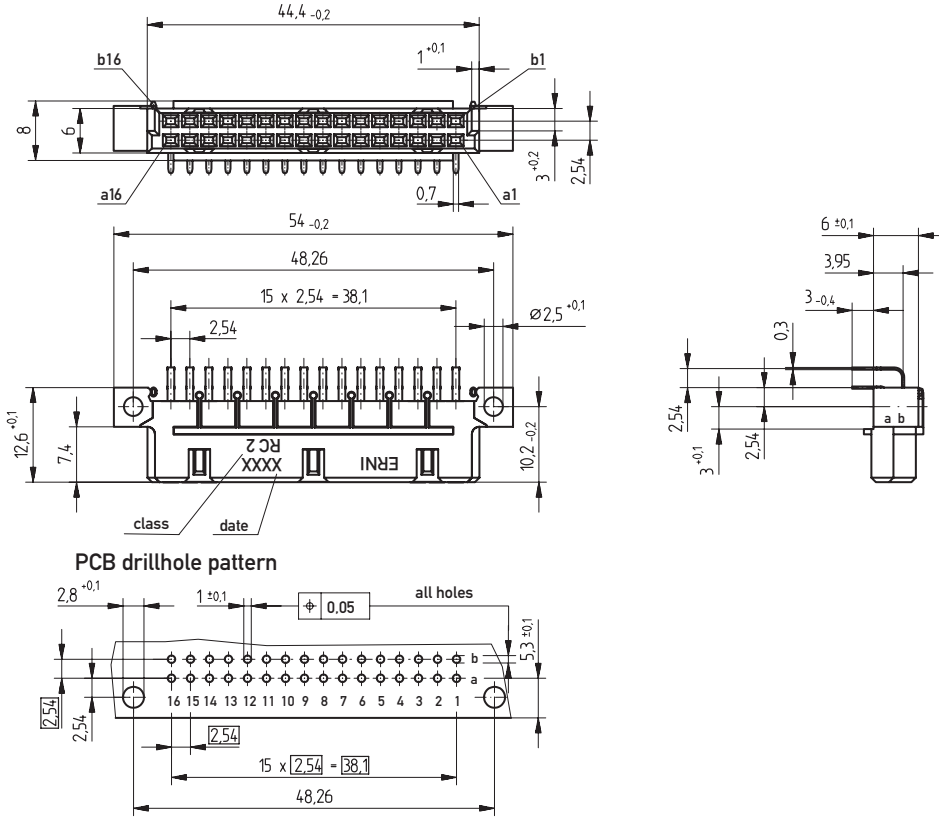

Dimensional Drawing Solder Type Q/3

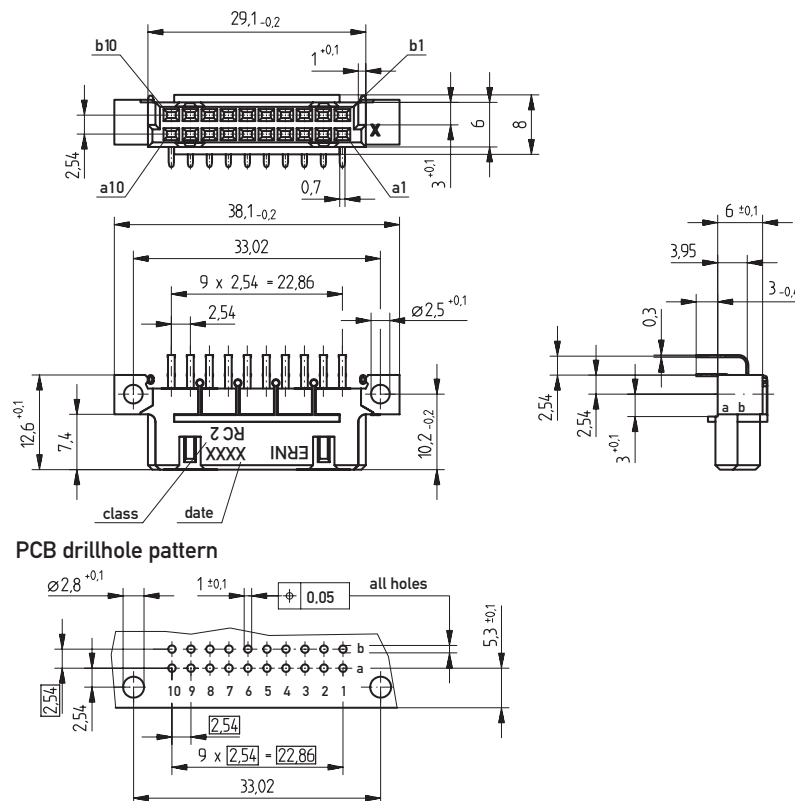

DIN 41612 / IEC 60603-2 Connectors

Type Q Female



Ordering Information

No. of Pins	Termination	Term. Length	Pin Dimensions	Class	Pressfit Zone	Part Number
-------------	-------------	--------------	----------------	-------	---------------	-------------

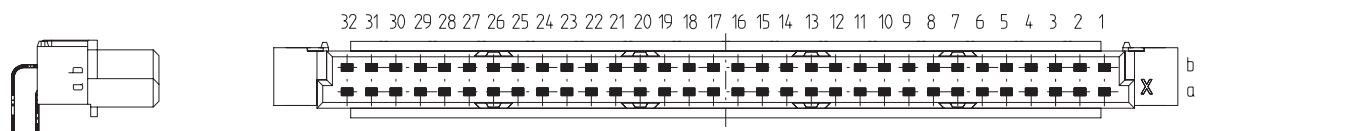

64	Pressfit	3 mm	0.6 x 0.6 mm	2	1 mm	364104
----	----------	------	--------------	---	------	---------------

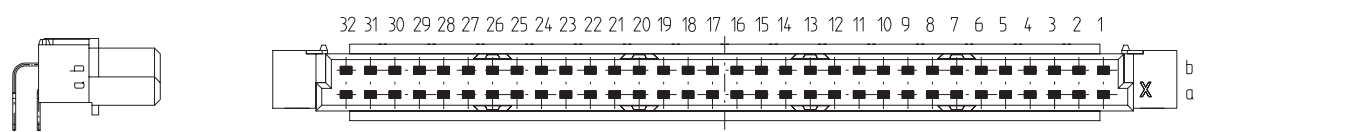

64	Solder	3 mm	0.7 x 0.3 mm	2	-	294721
----	--------	------	--------------	---	---	---------------

Type Q/2

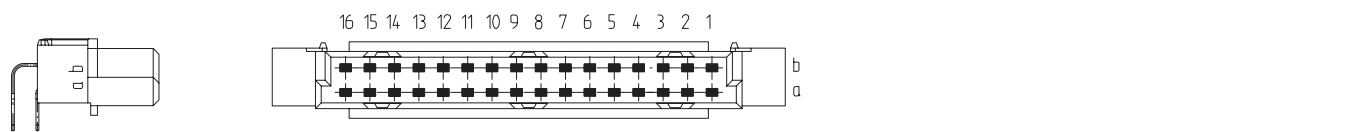

32	Solder	3 mm	0.7 x 0.3 mm	2	-	294722
----	--------	------	--------------	---	---	---------------

Type Q/3

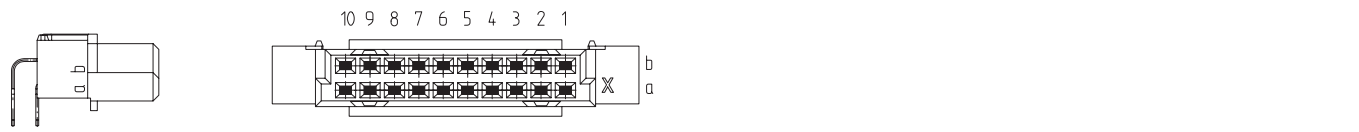

20	Solder	3 mm	0.7 x 0.3 mm	2	-	294927
----	--------	------	--------------	---	---	---------------

DIN 41612 / IEC 60603-2 Connectors

Type C Male

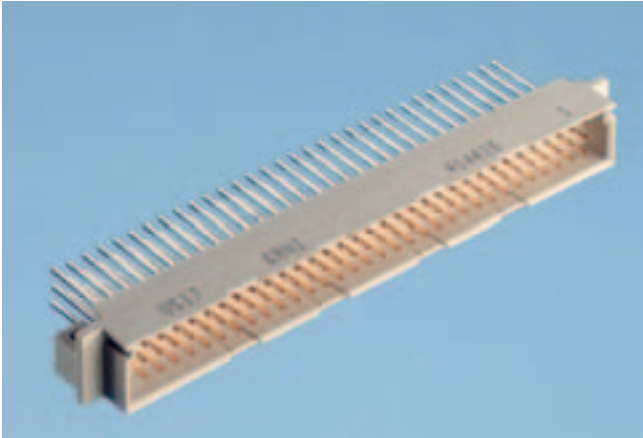

Dimensional Drawing Pressfit

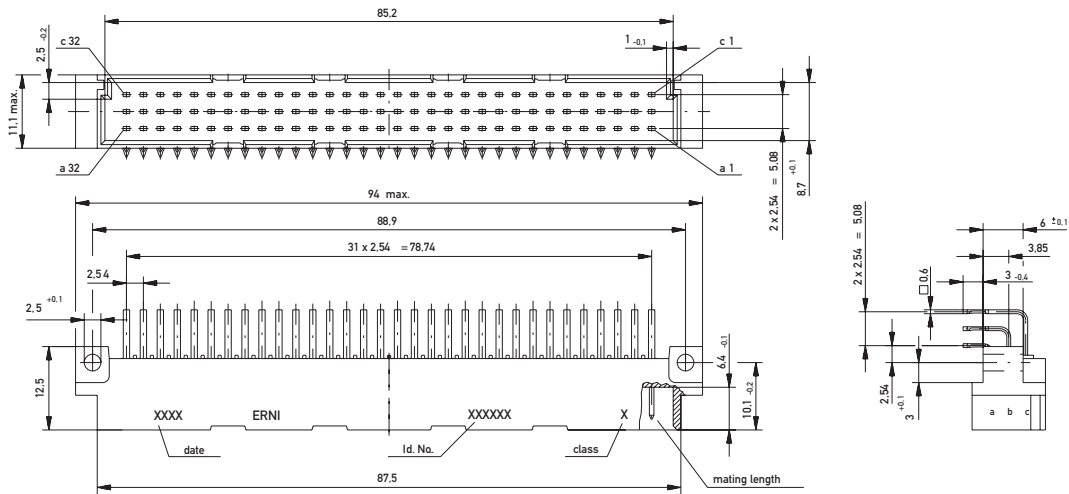

PCB drillhole pattern

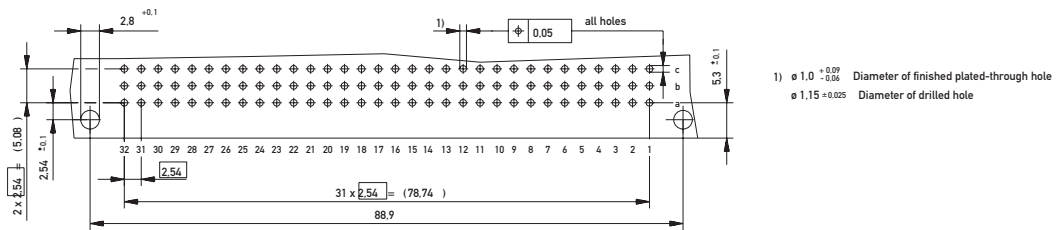

DIN 41612 / IEC 60603-2 Connectors

Type C Male



Dimensional Drawing Solder

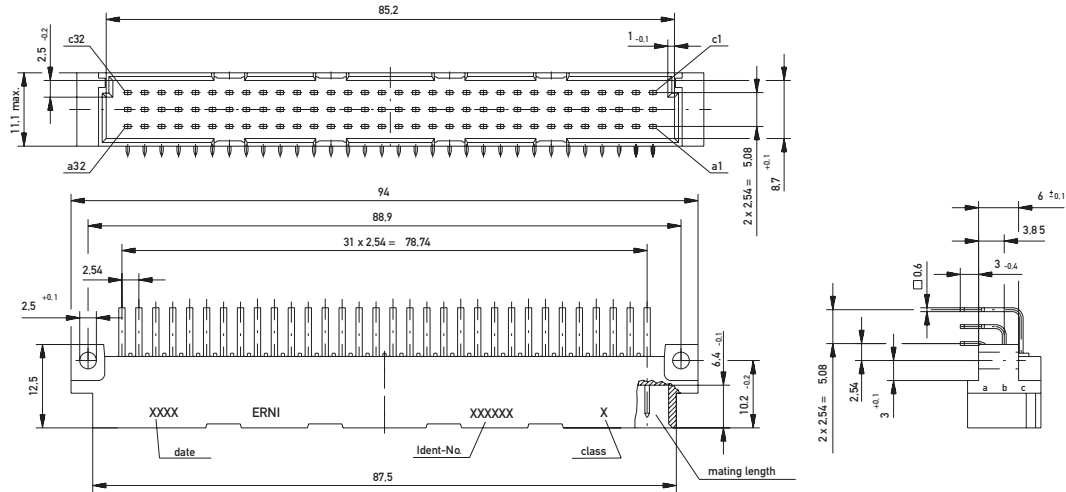

PCB drillhole pattern

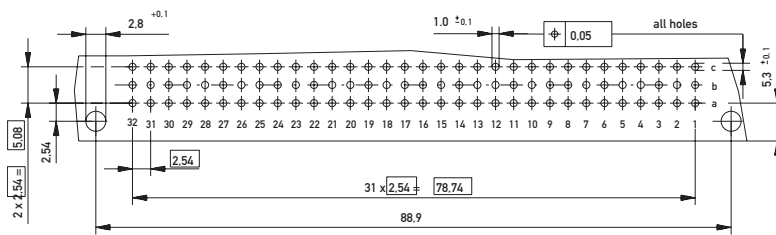

Dimensional Drawing THR

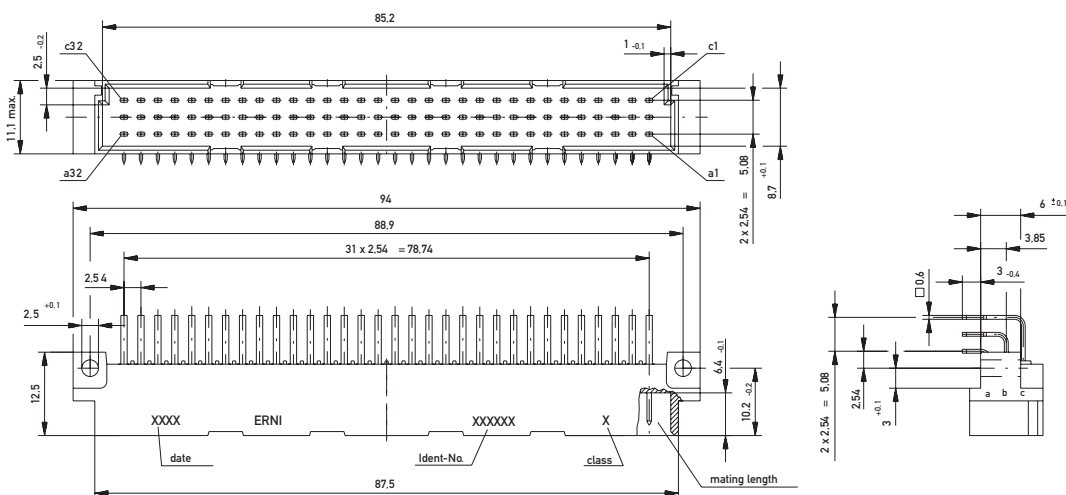

PCB drillhole pattern

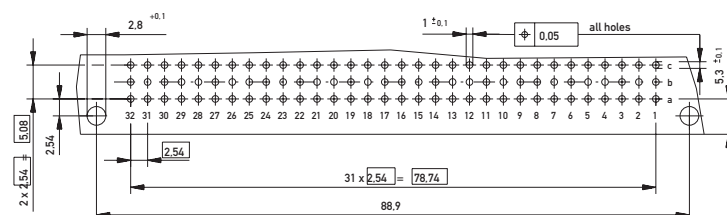

DIN 41612 / IEC 60603-2 Connectors

Type C Male

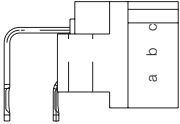
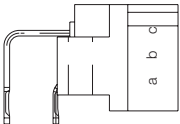
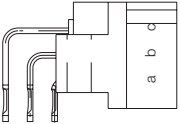
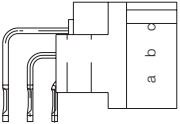
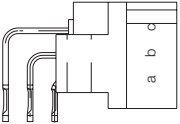

Ordering Information

No. of Pins	Termination	Term. Length	Pin Dimensions	Class	Pressfit Zone	Part Number
 32	Pressfit	3 mm	0.6 x 0.6 mm	2	1.5 mm	013254
 64	Pressfit	3 mm	0.6 x 0.6 mm	2	1.5 mm	013132
 64	Pressfit *	3 mm	0.6 x 0.6 mm	2	1.5 mm	063795
 96	Pressfit	3 mm	0.6 x 0.6 mm	2	1.5 mm	013131
 96	Pressfit *	3 mm	0.6 x 0.6 mm	2	1.5 mm	104552









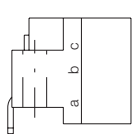
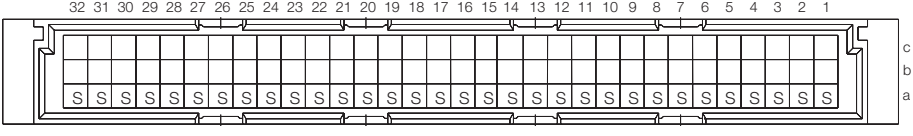
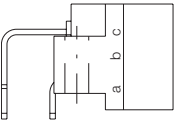
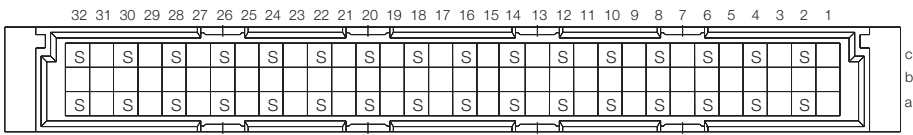

*For flat press-in tool.

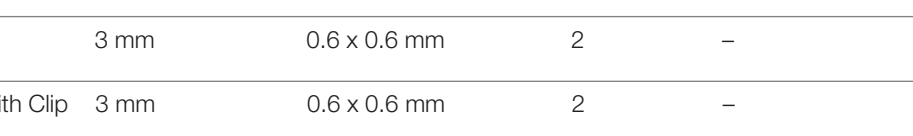
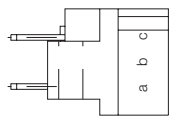
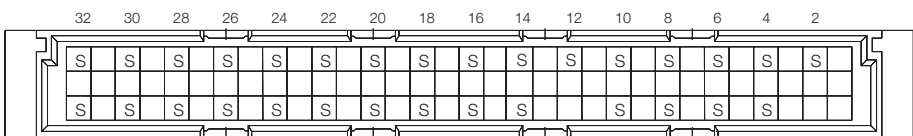
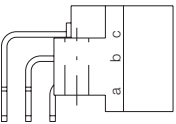
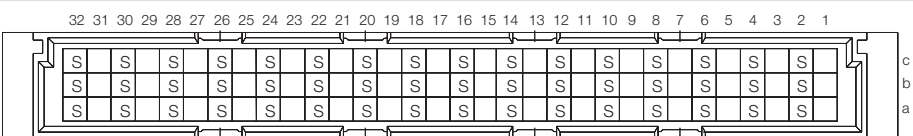
DIN 41612 / IEC 60603-2 Connectors

Type C Male

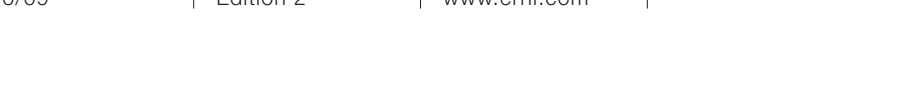

Ordering Information

No. of Pins	Termination	Term. Length	Pin Dimensions	Class	Pressfit Zone	Part Number
 	Solder	3 mm	0.6 x 0.6 mm	2	–	533404
 	Solder	3 mm	0.6 x 0.6 mm	1	–	533203
 	Solder	3 mm	0.6 x 0.6 mm	2	–	533403
 	Solder with Clip	3 mm	0.6 x 0.6 mm	2	–	023783
 	Solder	3.8 mm	0.6 x 0.6 mm	2	–	414401
 	Solder	12 mm	0.6 x 0.6 mm	1	–	414403
 	Solder	12 mm	0.6 x 0.6 mm	2	–	414404
 	Solder	3 mm	0.6 x 0.6 mm	2	–	533423
 	Solder with Clip	3 mm	0.6 x 0.6 mm	2	–	123751

Ordering Information

No. of Pins Termination Term. Length Pin Dimensions Class Pressfit Zone Part Number

No. of Pins	Termination	Term. Length	Pin Dimensions	Class	Pressfit Zone	Part Number
64	Solder	3 mm	0.6 x 0.6 mm	1	–	533201
	Solder	3 mm	0.6 x 0.6 mm	2	–	533401
	Solder with Clip	3 mm	0.6 x 0.6 mm	2	–	004413

No. of Pins	Termination	Term. Length	Pin Dimensions	Class	Pressfit Zone	Part Number
64	Solder	3.8 mm	0.6 x 0.6 mm	1	–	414406
	Solder	3.8 mm	0.6 x 0.6 mm	2	–	414407
	Solder	12 mm	0.6 x 0.6 mm	1	–	414409
	Solder	12 mm	0.6 x 0.6 mm	2	–	414410

No. of Pins	Termination	Term. Length	Pin Dimensions	Class	Pressfit Zone	Part Number
96	Solder	3 mm	0.6 x 0.6 mm	1	–	533202
	Solder	3 mm	0.6 x 0.6 mm	2	–	533402
	Solder with Clip	3 mm	0.6 x 0.6 mm	2	–	434325

No. of Pins	Termination	Term. Length	Pin Dimensions	Class	Pressfit Zone	Part Number
96	Solder	3.8 mm	0.6 x 0.6 mm	1	–	414412
	Solder	3.8 mm	0.6 x 0.6 mm	2	–	414413
	Solder	12 mm	0.6 x 0.6 mm	1	–	414415
	Solder	12 mm	0.6 x 0.6 mm	2	–	414416

DIN 41612 / IEC 60603-2 Connectors

Type C Male

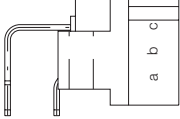
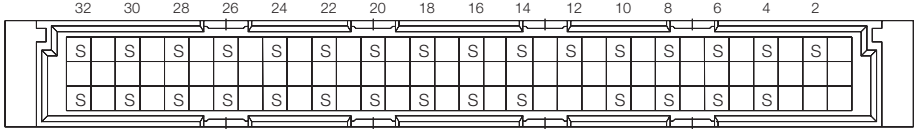
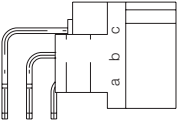
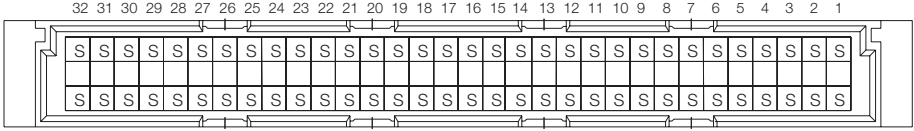
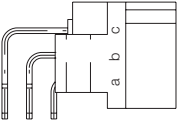
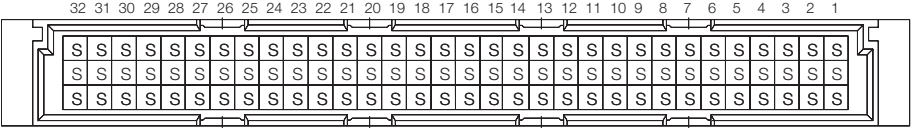

Ordering Information

No. of Pins	Termination	Term. Length	Pin Dimensions	Class	Pressfit Zone	Part Number
						
32	THR	3 mm	0.6 x 0.6 mm	2	–	223346
						
64	THR	3 mm	0.6 x 0.6 mm	2	–	063515
64	THR with Clip	3 mm	0.6 x 0.6 mm	2	–	164944
						
96	THR	3 mm	0.6 x 0.6 mm	2	–	134581
96	THR with Clip	3 mm	0.6 x 0.6 mm	2	–	144705

DIN 41612 / IEC 60603-2 Connectors

Type C/2 Male



Dimensional Drawing Pressfit

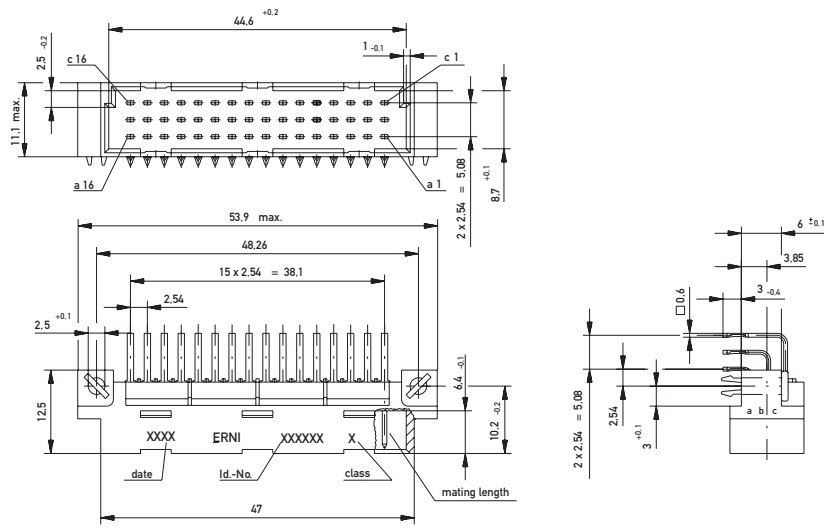

PCB drillhole pattern

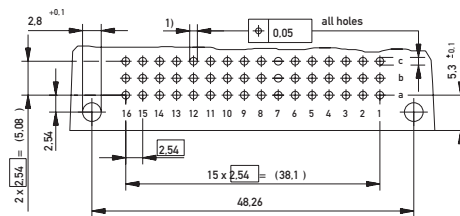

- 1) $\phi 1.0 \pm 0.09$ Diameter of finished plated-through hole
- $\phi 1.15 \pm 0.025$ Diameter of drilled hole

DIN 41612 / IEC 60603-2 Connectors

Type C/2 Male



Dimensional Drawing Solder

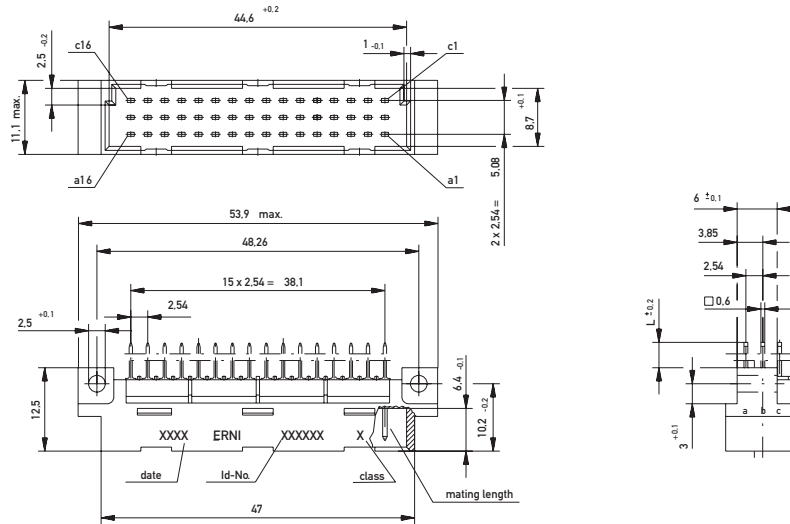

PCB drillhole pattern

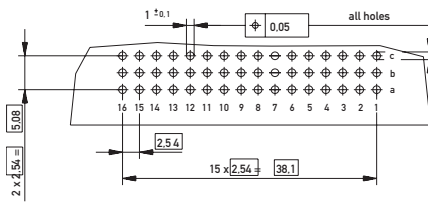

Dimensional Drawing THR

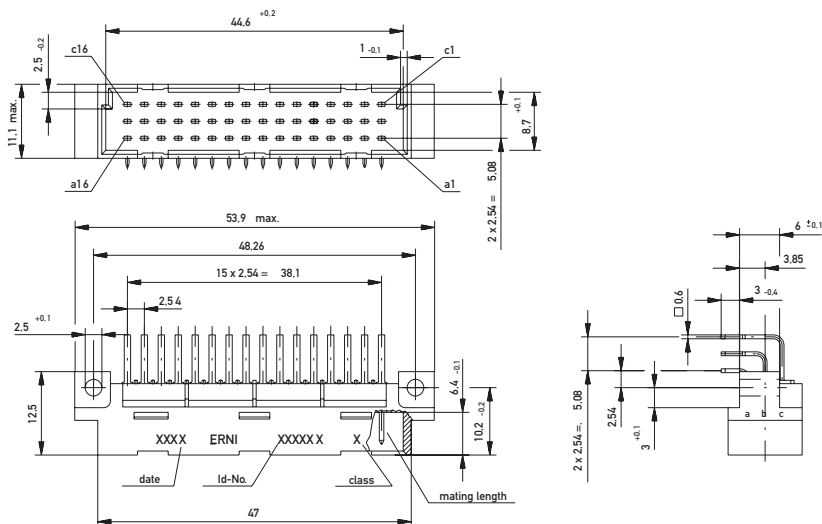

PCB drillhole pattern

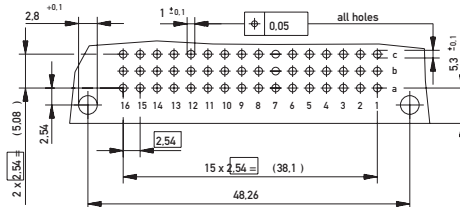









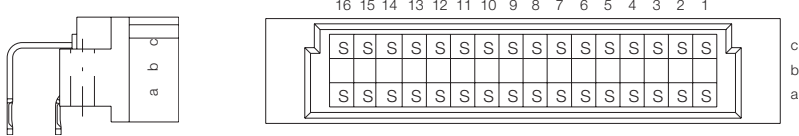
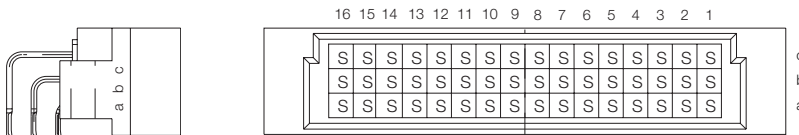
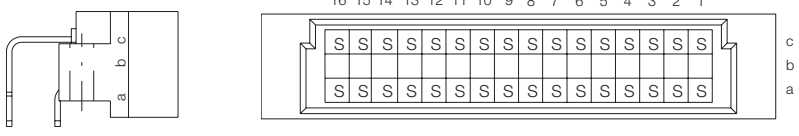

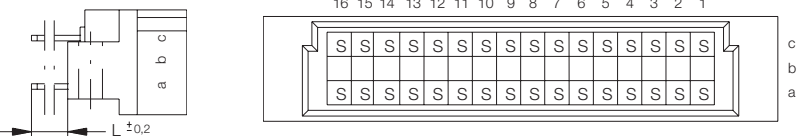
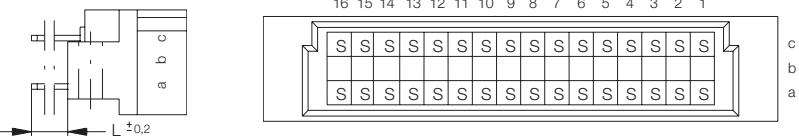
DIN 41612 / IEC 60603-2 Connectors

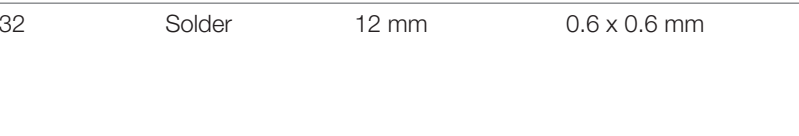
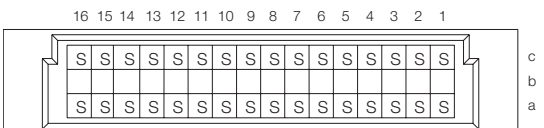
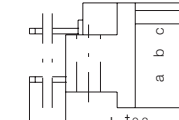
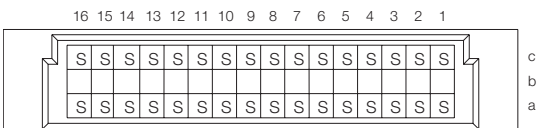
Type C/2 Male



Ordering Information

No. of Pins	Termination	Term. Length	Pin Dimensions	Class	Pressfit Zone	Part Number
 	Pressfit	3 mm	0.6 x 0.6 mm	2	1.5 mm	043582
 	Pressfit	3 mm	0.6 x 0.6 mm	2	1.5 mm	013136
 	Solder	3 mm	0.6 x 0.6 mm	1	–	413858
 	Solder	3 mm	0.6 x 0.6 mm	2	–	413859
 	Solder with Clip	3 mm	0.6 x 0.6 mm	2	–	123717
 	Solder	3.8 mm	0.6 x 0.6 mm	1	–	594633
 	Solder	3.8 mm	0.6 x 0.6 mm	2	–	594634
 	Solder	12 mm	0.6 x 0.6 mm	1	–	594635
 	Solder	12 mm	0.6 x 0.6 mm	2	–	594636

DIN 41612 / IEC 60603-2 Connectors

Type C/2 Male



Ordering Information

No. of Pins	Termination	Term. Length	Pin Dimensions	Class	Pressfit Zone	Part Number
48	Solder	3 mm	0.6 x 0.6 mm	1	–	413864
48	Solder	3 mm	0.6 x 0.6 mm	2	–	413865
48	Solder with Clip	3 mm	0.6 x 0.6 mm	2	–	434329
48	Solder	3.8 mm	0.6 x 0.6 mm	1	–	594400
48	Solder	3.8 mm	0.6 x 0.6 mm	2	–	594638
48	Solder	12 mm	0.6 x 0.6 mm	1	–	594640
48	Solder	12 mm	0.6 x 0.6 mm	2	–	594641
48	THR	3 mm	0.6 x 0.6 mm	2	–	154954
48	THR with Clip	3 mm	0.6 x 0.6 mm	–	–	123601

DIN 41612 / IEC 60603-2 Connectors

Type C/3 Male



Dimensional Drawing Pressfit

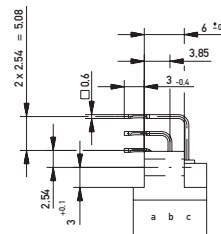
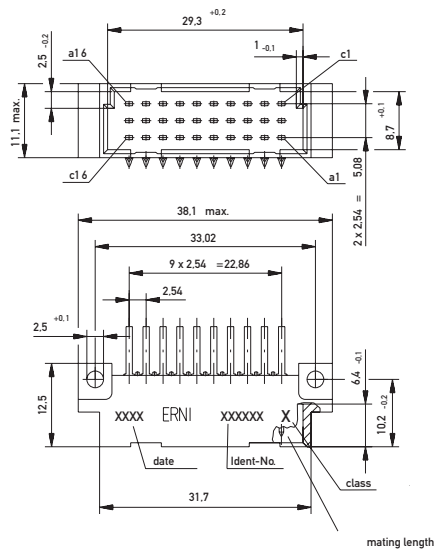

PCB drillhole pattern

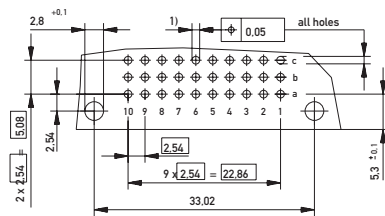

- 1) $\phi 1.0^{+0.09}$ Diameter of finished plated-through hole
- $\phi 1.15^{+0.025}$ Diameter of drilled hole

DIN 41612 / IEC 60603-2 Connectors

Type C/3 Male



Dimensional Drawing Solder

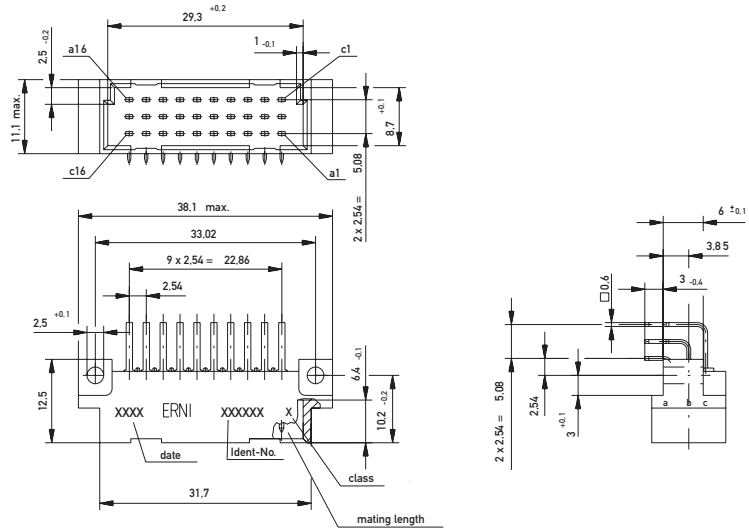

PCB drillhole pattern

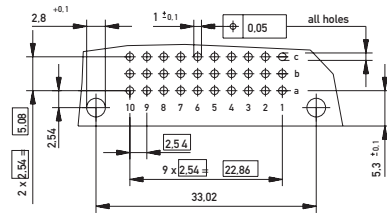

Dimensional Drawing THR

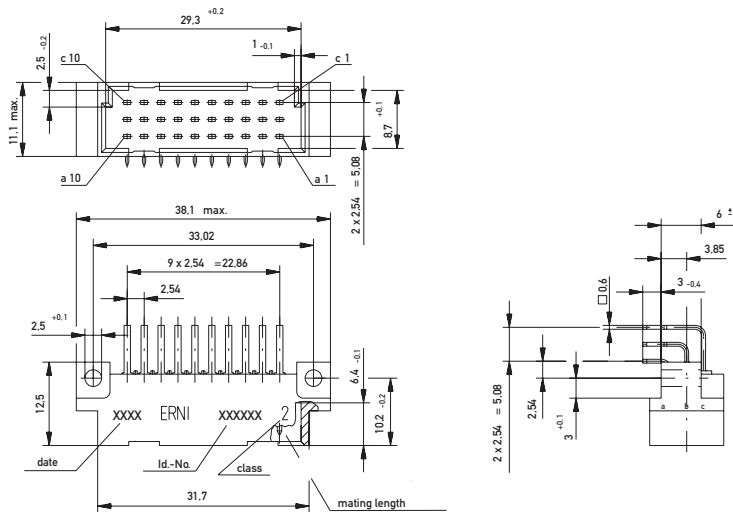

PCB drillhole pattern

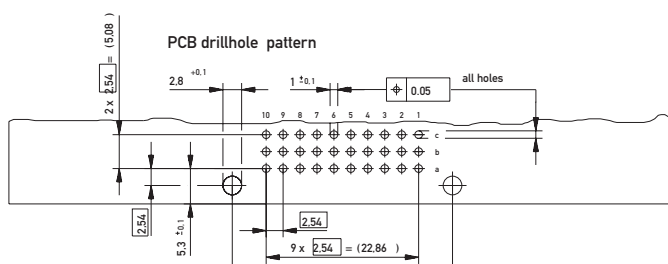

DIN 41612 / IEC 60603-2 Connectors

Type C/3 Male

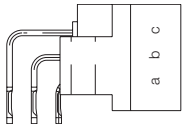
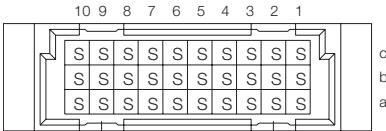
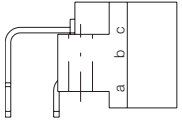
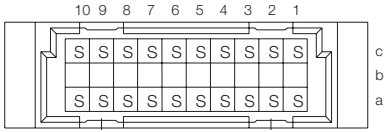
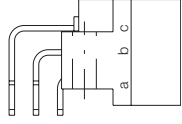
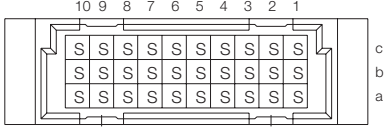
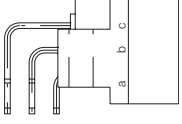
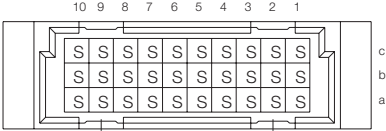

Ordering Information

No. of Pins	Termination	Term. Length	Pin Dimensions	Class	Pressfit Zone	Part Number
						
30	Pressfit	3 mm	0.6 x 0.6 mm	2	1.5 mm	013134
						
20	Solder	3 mm	0.6 x 0.6 mm	2	–	004362
						
30	Solder	3 mm	0.6 x 0.6 mm	1	–	424188
30	Solder	3 mm	0.6 x 0.6 mm	2	–	424189
30	Solder with Clip	3 mm	0.6 x 0.6 mm	2	–	123589
						
30	THR	3 mm	0.6 x 0.6 mm	2	–	154956
30	THR with Clip	3 mm	0.6 x 0.6 mm	2	–	154957

DIN 41612 / IEC 60603-2 Connectors

Type C Female

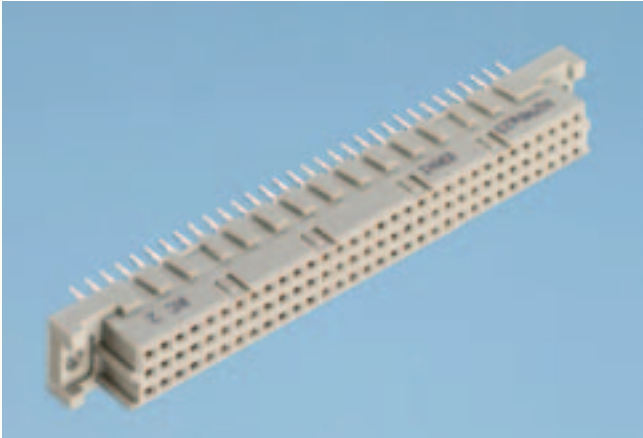

Dimensional Drawing Pressfit

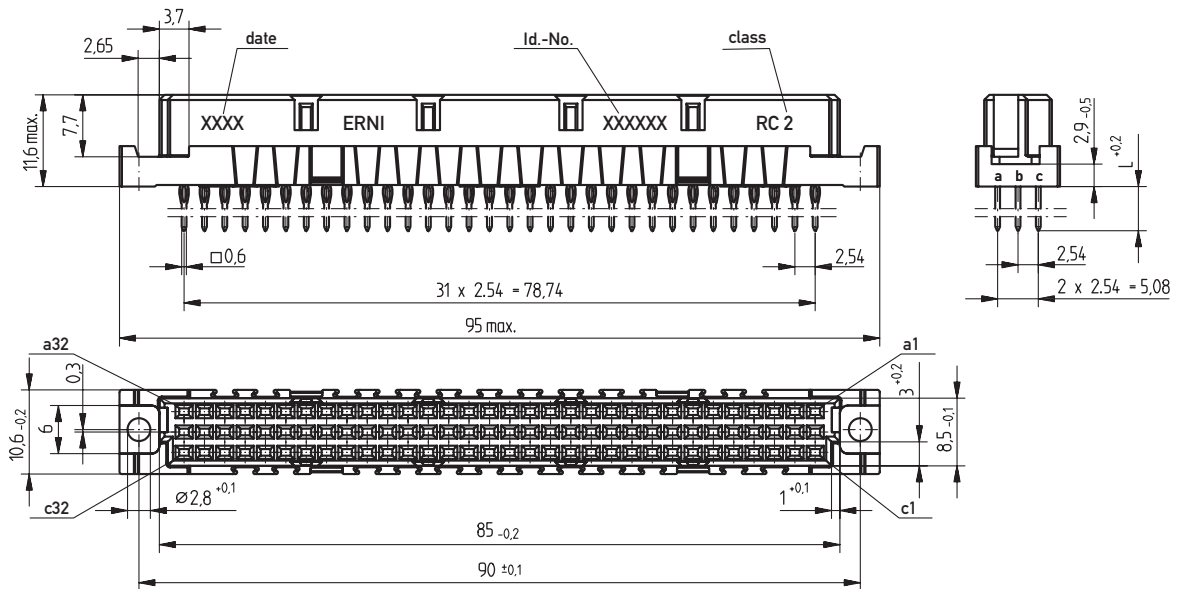

PCB drillhole pattern

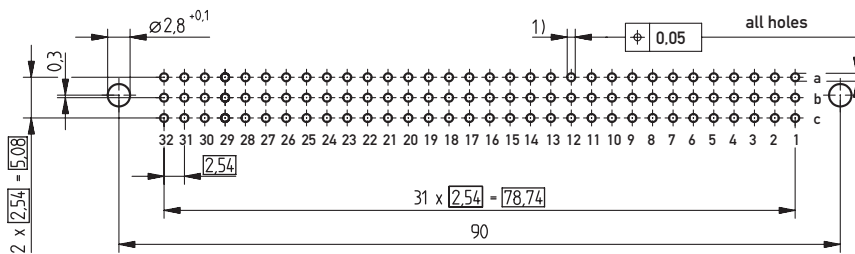

- 1) $\varnothing 1.0 \pm 0.09$ Diameter of finished plated-through hole
- $\varnothing 1.15 \pm 0.025$ Diameter of drilled hole

DIN 41612 / IEC 60603-2 Connectors

Type C Female



Dimensional Drawing Solder

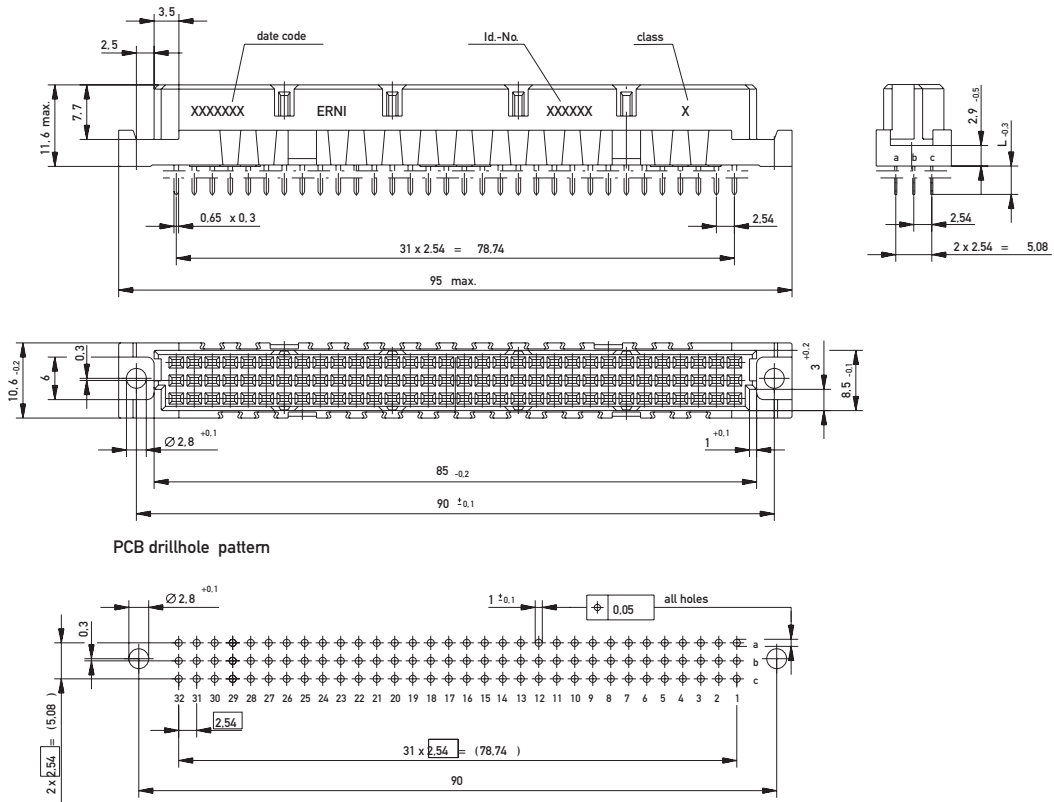

DIN 41612 / IEC 60603-2 Connectors

Type C Female



Dimensional Drawing THR

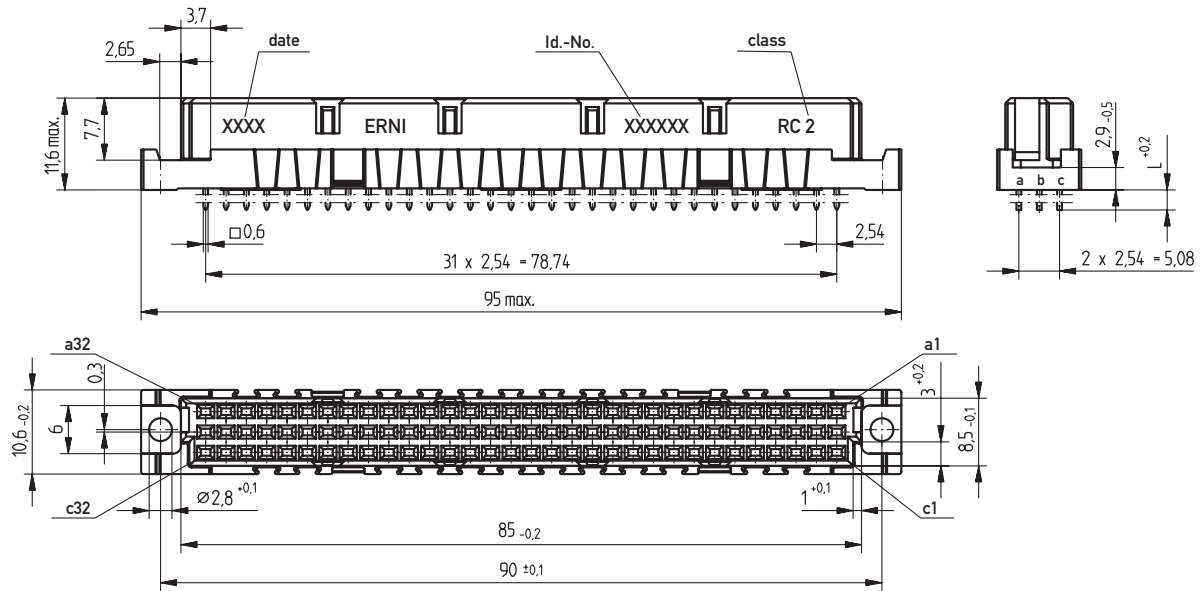

PCB drillhole pattern

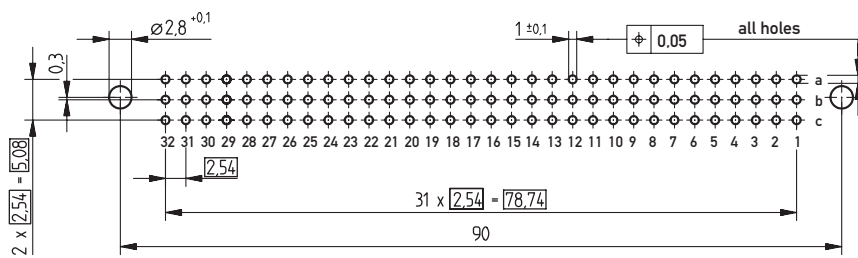

DIN 41612 / IEC 60603-2 Connectors

Type C Female

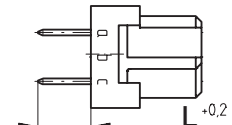
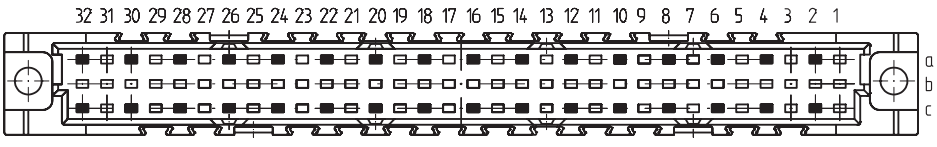
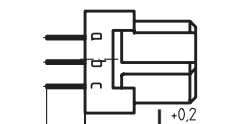
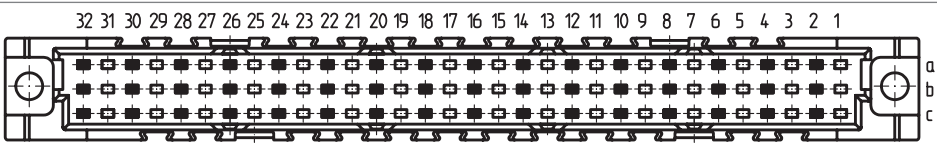

Ordering Information

No. of Pins	Termination	Term. Length	Pin Dimensions	Class	Pressfit Zone	Part Number
	Pressfit	5.5 mm	0.6 x 0.6 mm	2	-	
						254135
32	Pressfit	17 mm	0.6 x 0.6 mm	1	2.5 mm	284971
	Pressfit	4 mm	0.8 x 0.3 mm	2	-	
						234069
48	Pressfit	5.5 mm	0.6 x 0.6 mm	2	-	254136

DIN 41612 / IEC 60603-2 Connectors

Type C Female



Ordering Information

No. of Pins	Termination	Term. Length	Pin Dimensions	Class	Pressfit Zone	Part Number
64	Pressfit	2.9 mm	0.65 x 0.3 mm	2	2 mm	254120
64	Pressfit	4 mm	0.8 x 0.3 mm	2	–	244268
64	Pressfit w/o Flange	4.5 mm	0.65 x 0.3 mm	2	2 mm	294742
64	Pressfit	5.5 mm	0.6 x 0.6 mm	2	–	254137
64	Pressfit w/o Flange	5.5 mm	0.6 x 0.6 mm	2	–	254851
64	Pressfit New Design w. Transfer Zone	13 mm	0.6 x 0.6 mm	2	–	244126
64	Pressfit New Design	17 mm	0.6 x 0.6 mm	2	–	244294
64	Pressfit New Design w. Transfer Zone	17 mm	0.6 x 0.6 mm	2	–	224410

Ordering Information

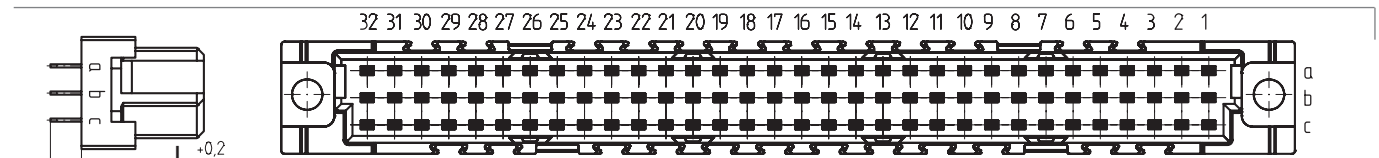
No. of Pins	Termination	Term. Length	Pin Dimensions	Class	Pressfit Zone	Part Number
						
96	Pressfit	2.9 mm	0.65 x 0.3 mm	2	–	254117
96	Pressfit	4 mm	0.8 x 0.3 mm	2	–	204752
96	Pressfit w/o Flange	4 mm	0.8 x 0.3 mm	2	–	254121
96	Pressfit	5.5 mm	0.6 x 0.6 mm	1	–	254015
96	Pressfit	5.5 mm	0.6 x 0.6 mm	2	–	224408
96	Pressfit w. Transfer Zone	13 mm	0.6 x 0.6 mm	2	–	284135
96	Pressfit New Design w. Transfer Zone	13 mm	0.6 x 0.6 mm	2	–	224412
96	Pressfit	17 mm	0.6 x 0.6 mm	1	–	284134
96	Pressfit New Design	17 mm	0.6 x 0.6 mm	2	–	234516
96	Pressfit w. Transfer Zone	17 mm	0.6 x 0.6 mm	1	–	284752
96	Pressfit New Design w. Transfer Zone	17 mm	0.6 x 0.6 mm	2	–	244295

DIN 41612 / IEC 60603-2 Connectors

Type C Female

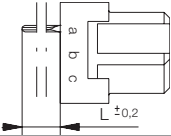
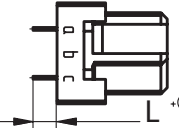

Ordering Information

No. of Pins	Termination	Term. Length	Pin Dimensions	Class	Pressfit Zone	Part Number
 32	Solder New Design	13 mm	0.6 x 0.6 mm	2	–	244296
 32	Solder	2.5 mm	0.65 x 0.3 mm	2	–	284652
32	Solder	4 mm	0.65 x 0.3 mm	1	–	284970
32	Solder	4 mm	0.65 x 0.3 mm	2	–	244265
32	Solder	13 mm	0.6 x 0.6 mm	1	–	284968
32	Solder New Design	13 mm	0.6 x 0.6 mm	2	–	244297
32	Solder New Design w. Transfer Zone	13 mm	0.6 x 0.6 mm	2	–	244298
32	Solder New Design w. Transfer Zone	17 mm	0.6 x 0.6 mm	2	–	244299

DIN 41612 / IEC 60603-2 Connectors

Type C Female



Ordering Information

No. of Pins	Termination	Term. Length	Pin Dimensions	Class	Pressfit Zone	Part Number
48	Solder	4 mm	0.65 x 0.3 mm	1	–	284975
48	Solder New Design with Clip	4 mm	0.65 x 0.3 mm	2	–	234432
48	Solder	4 mm	0.65 x 0.3 mm	2	–	284082
48	Solder New Design	13 mm	0.6 x 0.6 mm	2	–	244300

DIN 41612 / IEC 60603-2 Connectors

Type C Female



Ordering Information

No. of Pins	Termination	Term. Length	Pin Dimensions	Class	Pressfit Zone	Part Number
64	Solder w. retaining Loop	2.5 mm	0.65 x 0.3 mm	2	–	284170
64	Solder	4 mm	0.65 x 0.3 mm	1	–	284979
64	Solder New Design	4 mm	0.65 x 0.3 mm	2	–	224411
64	Solder New Design with Clip	4 mm	0.65 x 0.3 mm	2	–	224471
64	Solder w. retaining Loop	4 mm	0.8 x 0.3 mm	2	–	223839
64	Solder	13 mm	0.6 x 0.6 mm	1	–	284977
64	Solder New Design	13 mm	0.6 x 0.6 mm	2	–	244301
64	Solder New Design w. Transfer Zone	13 mm	0.6 x 0.6 mm	2	–	244302
64	Solder w. Transfer Zone	17 mm	0.6 x 0.6 mm	1	–	284976
64	Solder New Design w. Transfer Zone	17 mm	0.6 x 0.6 mm	2	–	244303

DIN 41612 / IEC 60603-2 Connectors

Type C Female



Ordering Information

No. of Pins	Termination	Term. Length	Pin Dimensions	Class	Pressfit Zone	Part Number
96	Solder	2.5 mm	0.65 x 0.3 mm	2	–	224470
96	Solder w. retaining Loop	2.5 mm	0.65 x 0.3 mm	2	–	284991
96	Solder	4 mm	0.65 x 0.3 mm	1	–	254897
96	Solder New Design	4 mm	0.65 x 0.3 mm	2	–	214836
96	Solder w. retaining Loop	4 mm	0.65 x 0.3 mm	2	–	284308
96	Solder	13 mm	0.6 x 0.6 mm	1	–	284984
96	Solder New Design	13 mm	0.6 x 0.6 mm	2	–	244304
96	Solder New Design w. Transfer Zone	13 mm	0.6 x 0.6 mm	2	–	244305
96	Solder New Design	17 mm	0.6 x 0.6 mm	2	–	244306
96	Solder w. Transfer Zone	17 mm	0.6 x 0.6 mm	1	–	254931
96	Solder New Design w. Transfer Zone	17 mm	0.6 x 0.6 mm	2	–	244307

DIN 41612 / IEC 60603-2 Connectors

Type C Female

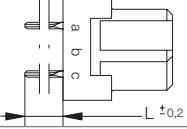
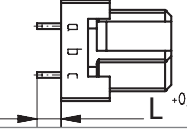
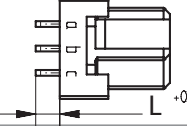

Ordering Information

No. of Pins	Termination	Term. Length	Pin Dimensions	Class	Pressfit Zone	Part Number
 32	THR	2.9 mm	0.3 x 0.65 mm	2	–	223368
 64	THR	2.5 mm	0.6 x 0.6 mm	2	–	224475
64	THR	2.5 mm	0.6 x 0.6 mm	2	–	224476
 96	THR	2.5 mm	0.6 x 0.6 mm	2	–	224473
96	THR	2.5 mm	0.6 x 0.6 mm	2	–	224474

DIN 41612 / IEC 60603-2 Connectors

Type C/2 Female



Dimensional Drawing Pressfit

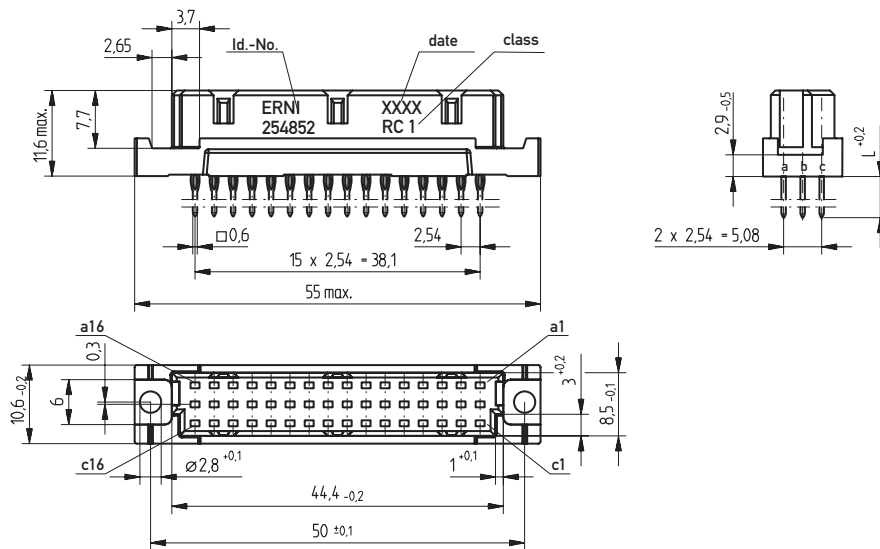

PCB drillhole pattern

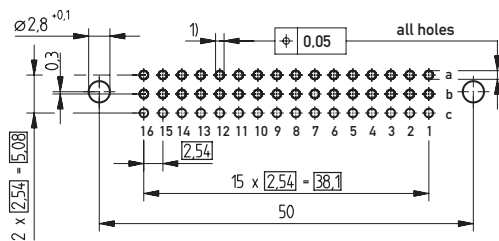

- 1) ∅ 1,0 ±0,02 Diameter of finished plated-through hole
- ∅ 1,15 ±0,025 Diameter of drilled hole

DIN 41612 / IEC 60603-2 Connectors

Type C/2 Female



Dimensional Drawing Solder

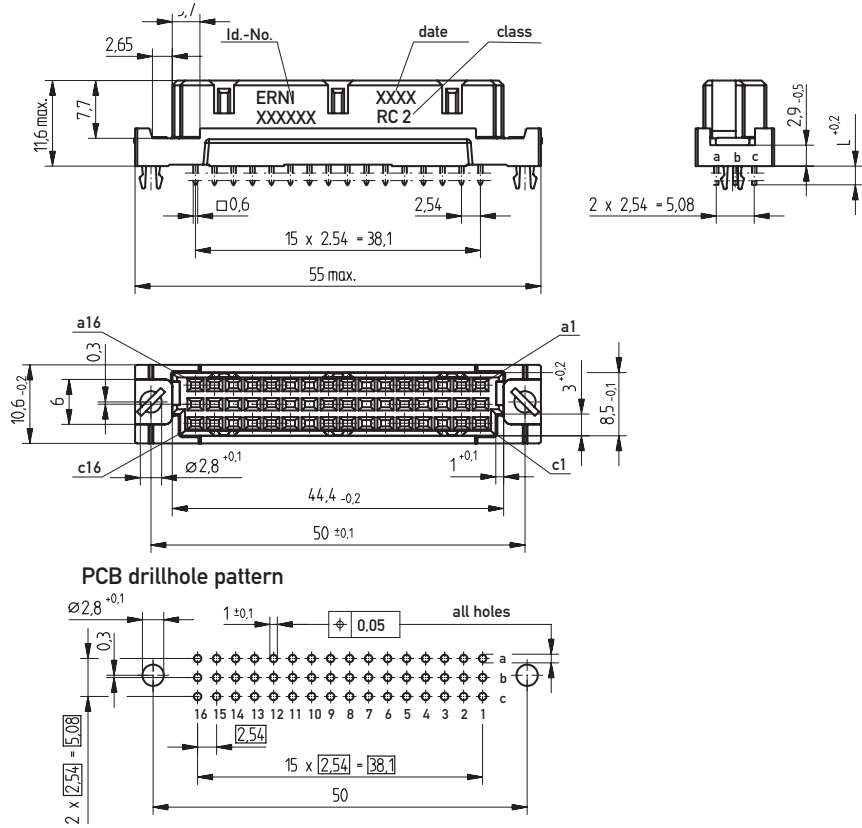

Dimensional Drawing THR

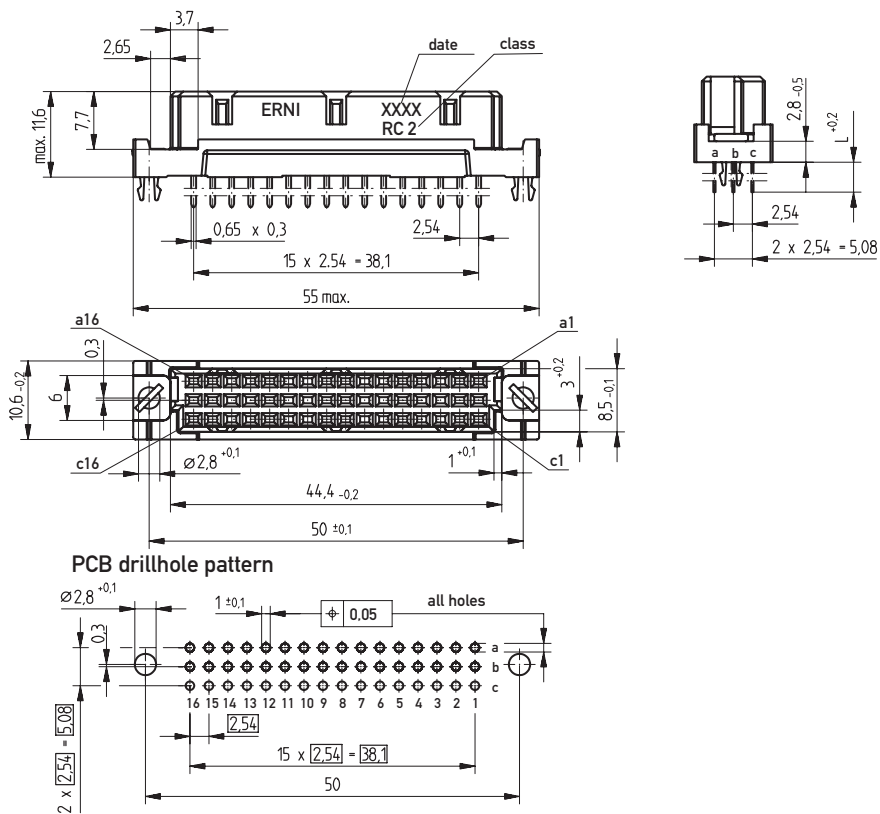

DIN 41612 / IEC 60603-2 Connectors

Type C/2 Female



Ordering Information

No. of Pins	Termination	Term. Length	Pin Dimensions	Class	Pressfit Zone	Part Number
32	Pressfit	5.5 mm	0.6 x 0.6 mm	2	–	254854
32	Pressfit	13 mm	0.6 x 0.6 mm	2	–	294738
48	Pressfit	4 mm	0.8 x 0.3 mm	2	–	254887
48	Pressfit	5.5 mm	0.6 x 0.6 mm	1	–	254852
48	Pressfit	5.5 mm	0.6 x 0.6 mm	2	–	234647
48	Pressfit w. Transfer Zone	13 mm	0.6 x 0.6 mm	2	–	284136
48	Pressfit w. Transfer Zone	17 mm	0.6 x 0.6 mm	2	–	254896
32	Solder	2.5 mm	0.65 x 0.3 mm	2	–	254893
32	Solder	4 mm	0.65 x 0.3 mm	1	–	284933
32	Solder	4 mm	0.65 x 0.3 mm	2	–	284171
32	Solder	13 mm	0.6 x 0.6 mm	2	–	284323
32	Solder	13 mm	0.6 x 0.6 mm	2	–	414327

DIN 41612 / IEC 60603-2 Connectors

Type C/2 Female



Ordering Information

No. of Pins	Termination	Term. Length	Pin Dimensions	Class	Pressfit Zone	Part Number
	Solder	2.5 mm	0.65 x 0.3 mm	1	–	284035
	Solder	2.5 mm	0.65 x 0.3 mm	2	–	254498
	Solder w/o Flange	2.5 mm	0.65 x 0.3 mm	2	–	284942
	Solder	4 mm	0.65 x 0.3 mm	2	–	284174
	Solder w/o Flange	4 mm	0.65 x 0.3 mm	2	–	284175
	Solder	4 mm	0.65 x 0.3 mm	1	–	254895
	Solder with Clip	4 mm	0.65 x 0.3 mm	2	–	284944
	Solder	13 mm	0.6 x 0.6 mm	1	–	284941
	Solder	13 mm	0.6 x 0.6 mm	2	–	284172
	Solder	17 mm	0.6 x 0.6 mm	2	–	284938
	THR with Clip	2.5 mm	0.6 x 0.6 mm	2	–	254970

DIN 41612 / IEC 60603-2 Connectors

Type C/3 Female



Dimensional Drawing Pressfit

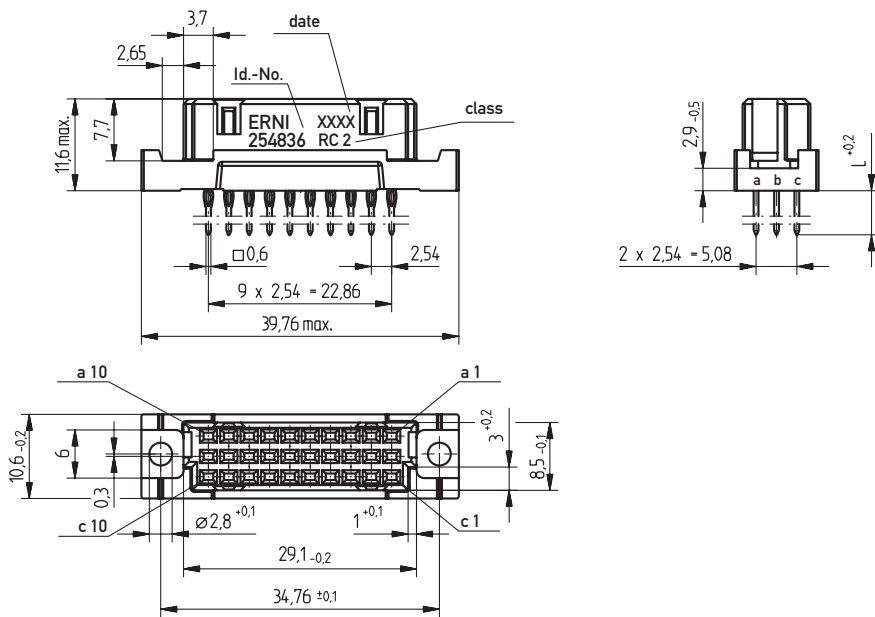

PCB drillhole pattern

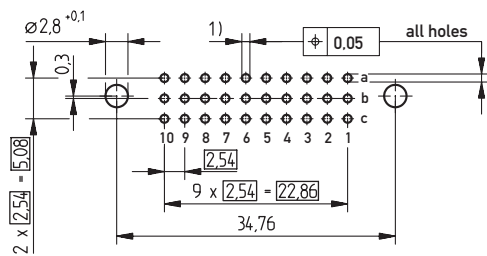

- 1) $\varnothing 1,0^{+0,09}_{-0,06}$ Diameter of finished plated-through hole
- $\varnothing 1,15^{+0,025}$ Diameter of drilled hole

DIN 41612 / IEC 60603-2 Connectors

Type C/3 Female



Dimensional Drawing Solder

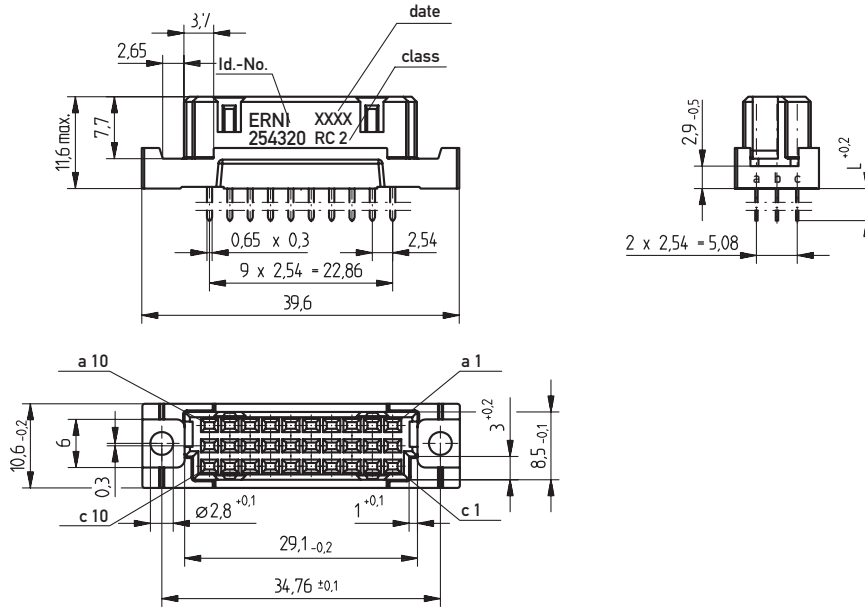

PCB drillhole pattern

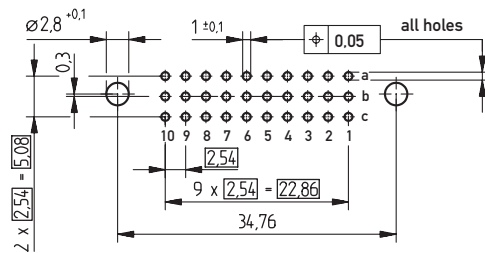





DIN 41612 / IEC 60603-2 Connectors

Type C/3 Female

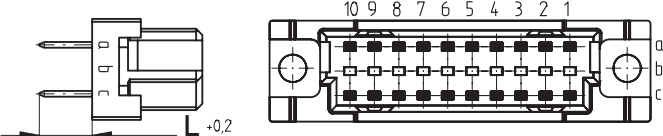
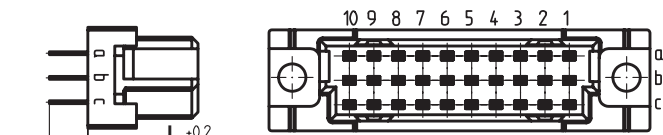

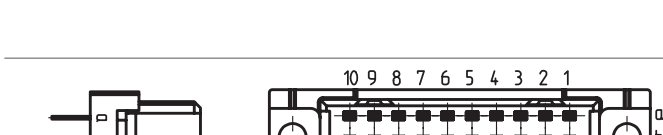
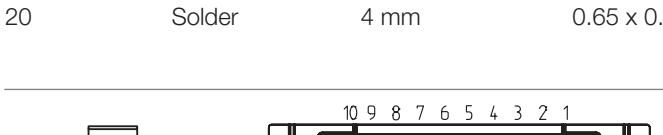
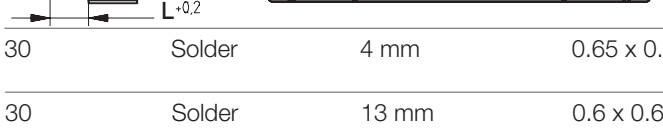
Ordering Information

No. of Pins	Termination	Term. Length	Pin Dimensions	Class	Pressfit Zone	Part Number
	Pressfit	5.5 mm	0.6 x 0.6 mm	2	–	254838
	Pressfit	4 mm	0.8 x 0.3 mm	2	–	254995
	Pressfit	5.5 mm	0.6 x 0.6 mm	2	–	254836
	Pressfit w/o Flange	5.5 mm	0.6 x 0.6 mm	2	–	254321
	Pressfit w. Transfer Zone	13 mm	0.6 x 0.6 mm	2	–	284176
	Solder	4 mm	0.65 x 0.3 mm	2	–	284318
	Solder	4 mm	0.65 x 0.3 mm	2	–	254320
	Solder	13 mm	0.6 x 0.6 mm	2	–	284173

DIN 41612 / IEC 60603-2 Connectors

Type R Male



Dimensional Drawing Pressfit

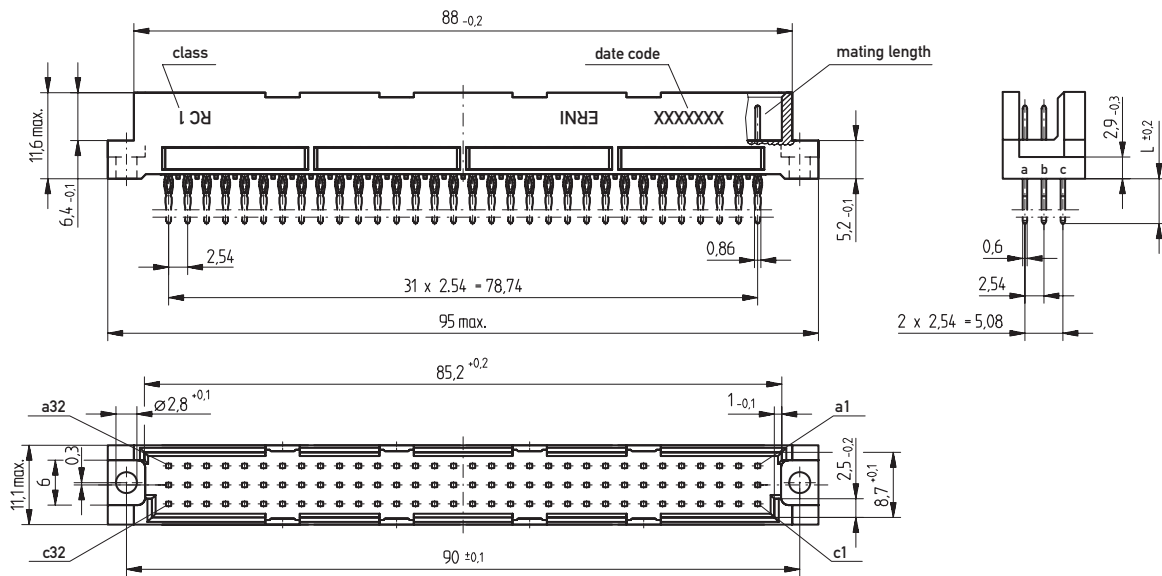

PCB drillhole pattern

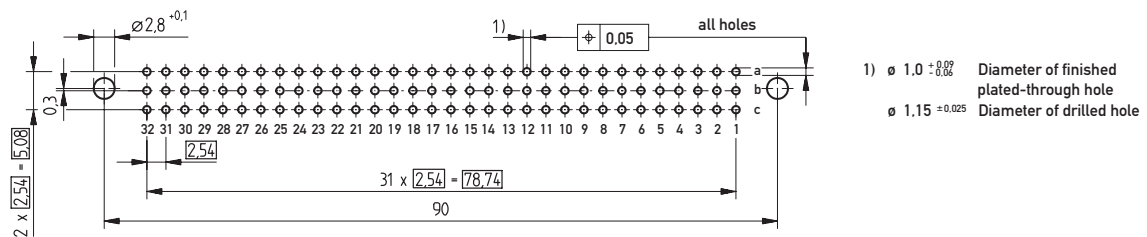



Dimensional Drawing Solder

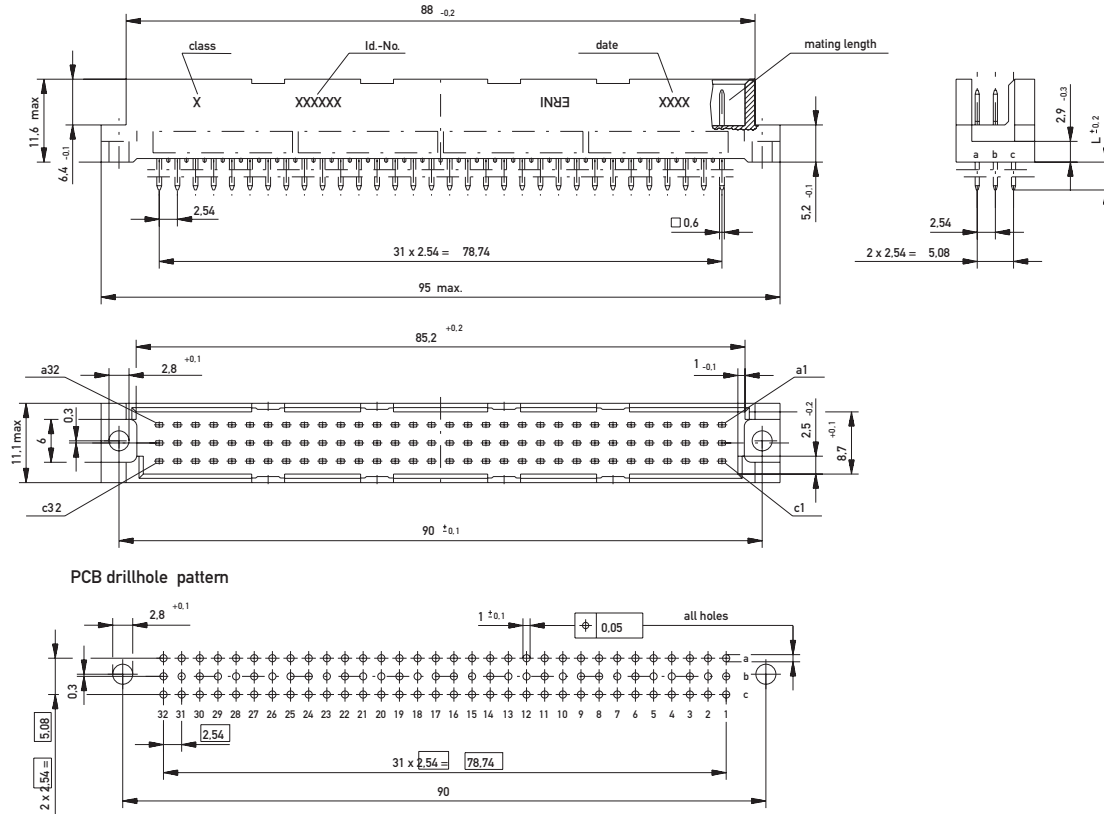

Dimensional Drawing THR

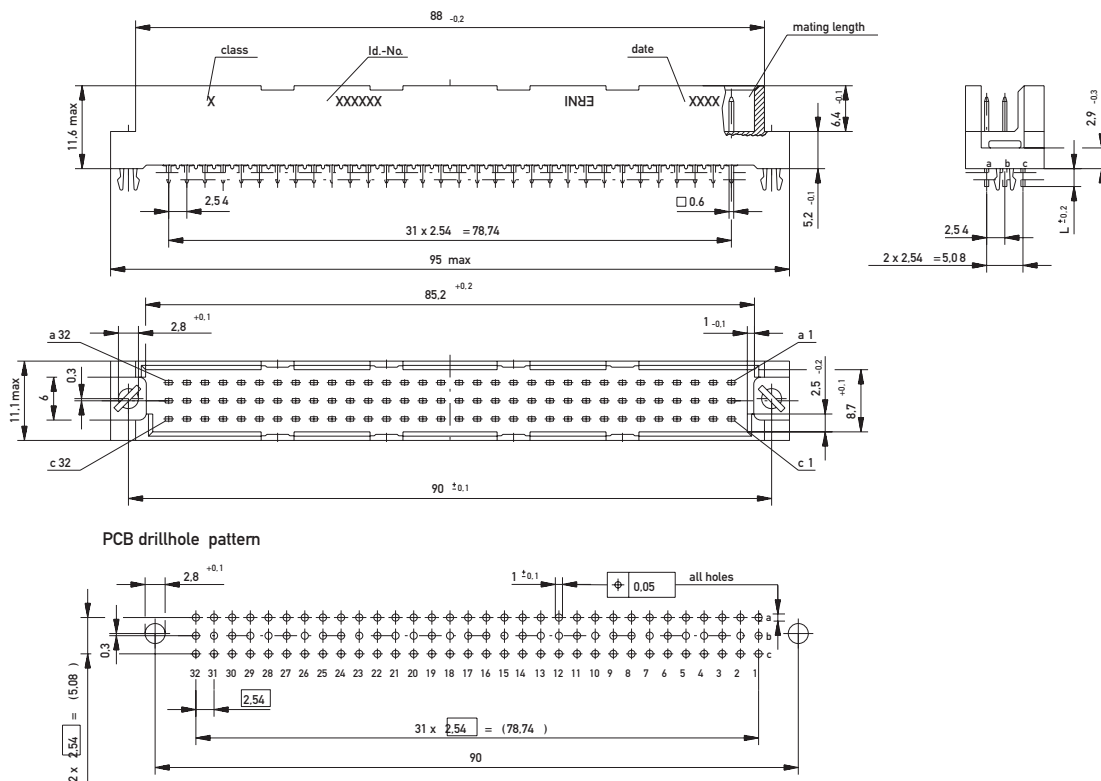

DIN 41612 / IEC 60603-2 Connectors

Type R Male



Ordering Information

No. of Pins	Termination	Term. Length	Pin Dimensions	Class	Pressfit Zone	Part Number
64	Pressfit	6 mm	0.6 x 0.6 mm	1	–	354385
64	Pressfit	6 mm	0.86 x 0.6 mm	2	–	234713
64	Pressfit w. Transfer Zone	13 mm	0.6 x 0.6 mm	2	–	354381
64	Pressfit	20 mm	0.6 x 0.6 mm	2	–	354395
64	Pressfit w. Transfer Zone	20 mm	0.6 x 0.6 mm	2	–	354400
96	Pressfit	6 mm	0.86 x 0.6 mm	1	–	354418
96	Pressfit	6 mm	0.86 x 0.6 mm	2	–	234712
96	Pressfit w. Transfer Zone	13 mm	0.6 x 0.6 mm	2	–	284420
96	Pressfit	20 mm	0.86 x 0.6 mm	1	–	354396
96	Pressfit	20 mm	0.86 x 0.6 mm	2	–	354399
96	Pressfit w. Transfer Zone	20 mm	0.6 x 0.6 mm	1	2.5 mm	414702
96	Pressfit w. Transfer Zone	20 mm	0.86 x 0.6 mm	2	–	254141



Ordering Information

No. of Pins Termination Term. Length Pin Dimensions Class Pressfit Zone Part Number

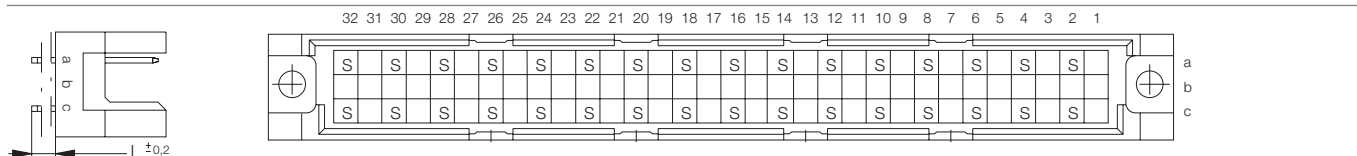

32	Solder	4 mm	0.6 x 0.6 mm	1	–	304225
32	Solder	4 mm	0.6 x 0.6 mm	2	–	304425
32	Solder	13 mm	0.6 x 0.6 mm	1	–	304221
32	Solder	13 mm	0.6 x 0.6 mm	2	–	304421

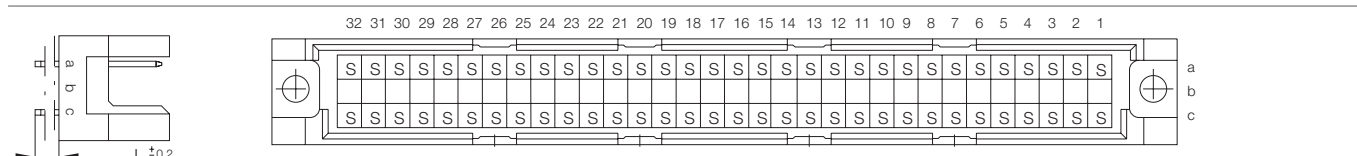

64	Solder	4 mm	0.6 x 0.6 mm	1	–	334214
64	Solder	4 mm	0.6 x 0.6 mm	2	–	334414
64	Solder	13 mm	0.6 x 0.6 mm	1	–	334210
64	Solder	13 mm	0.6 x 0.6 mm	2	–	334410

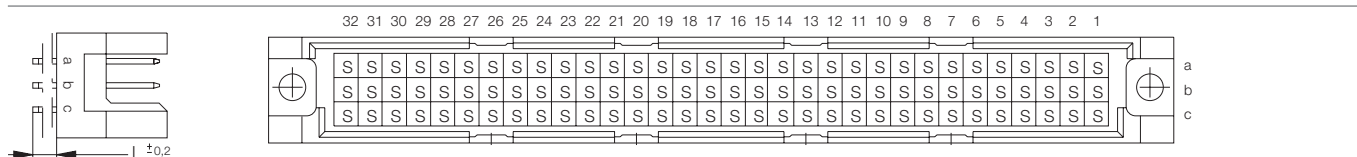

96	Solder	4 mm	0.6 x 0.6 mm	1	–	334215
96	Solder	4 mm	0.6 x 0.6 mm	2	–	334415
96	Solder	13 mm	0.6 x 0.6 mm	1	–	334211
96	Solder	13 mm	0.6 x 0.6 mm	2	–	334411

DIN 41612 / IEC 60603-2 Connectors

Type R Male



Ordering Information

No. of Pins	Termination	Term. Length	Pin Dimensions	Class	Pressfit Zone	Part Number
64	THR	2.5 mm	0.6 x 0.6 mm	2	–	194576
64	THR with Clip	2.5 mm	0.6 x 0.6 mm	2	–	194578
96	THR	2.5 mm	0.6 x 0.6 mm	2	–	164306
96	THR with Clip	2.5 mm	0.6 x 0.6 mm	2	–	154961

DIN 41612 / IEC 60603-2 Connectors

Type R/2 Male



Dimensional Drawing Pressfit

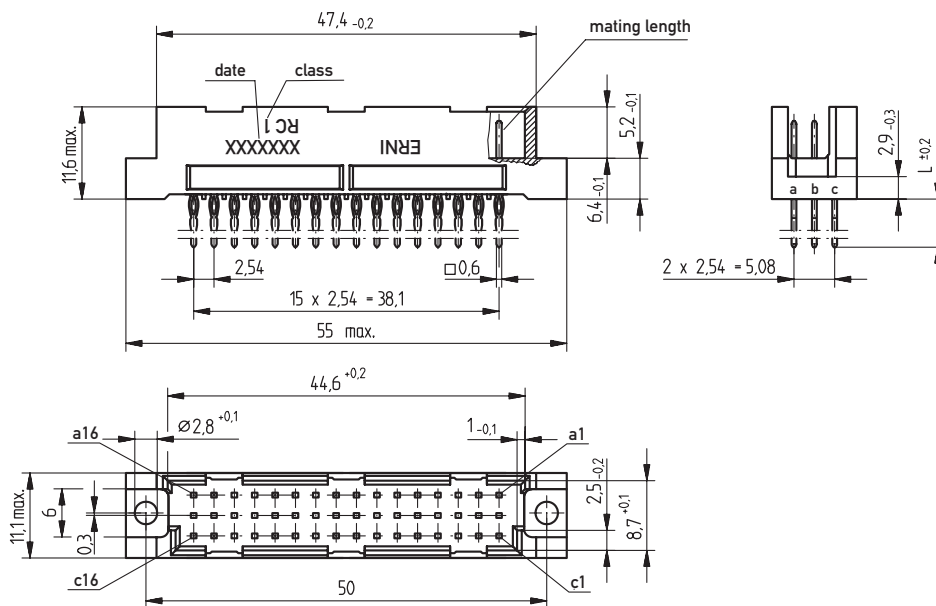

PCB drillhole pattern

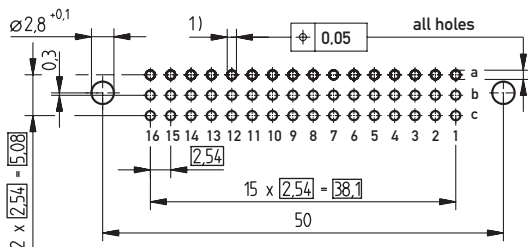

- 1) $\varnothing 1,0_{+0,009}$ Diameter of finished plated-through hole
- $\varnothing 1,15_{+0,025}$ Diameter of drilled hole

DIN 41612 / IEC 60603-2 Connectors

Type R/2 Male



Dimensional Drawing Solder

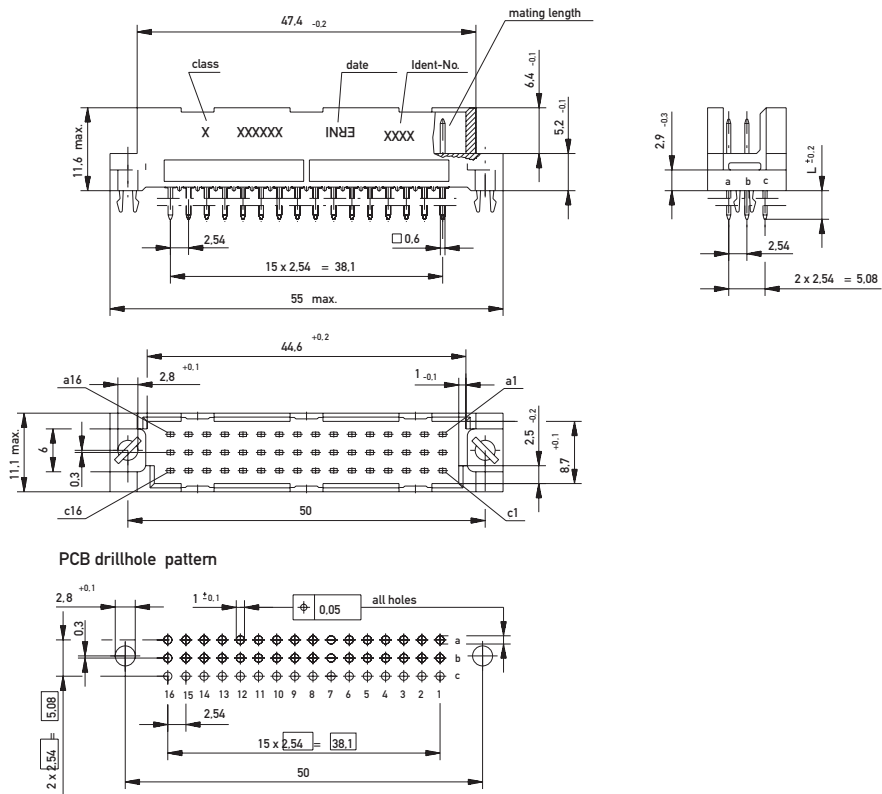

Dimensional Drawing THR

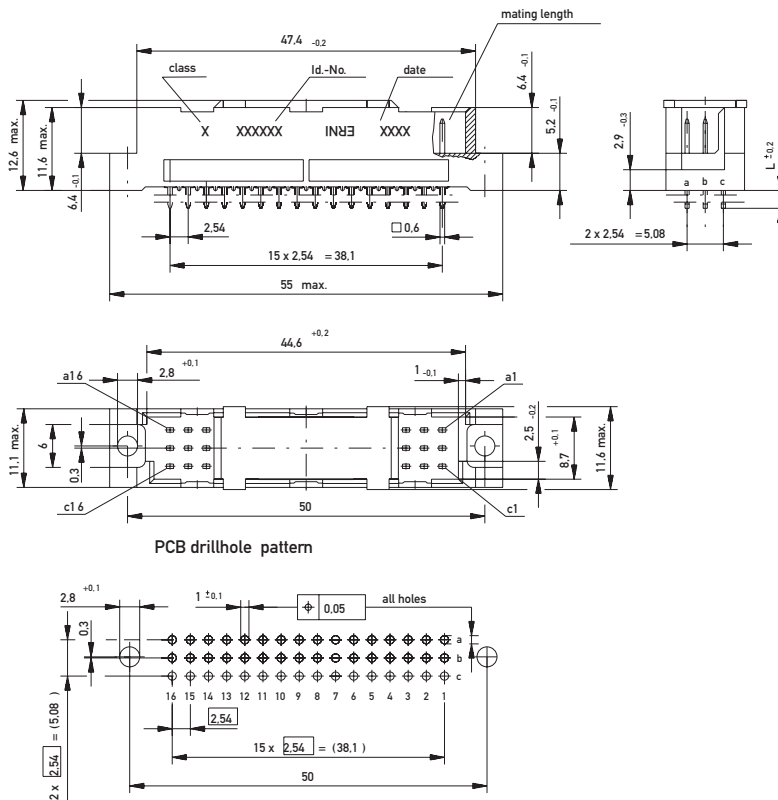



DIN 41612 / IEC 60603-2 Connectors

Type R/2 Male

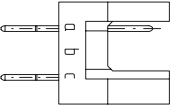
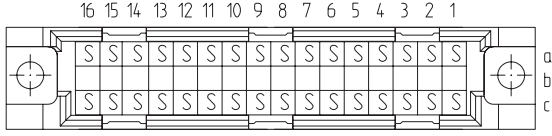
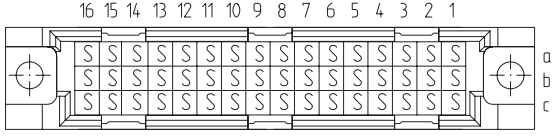

Ordering Information

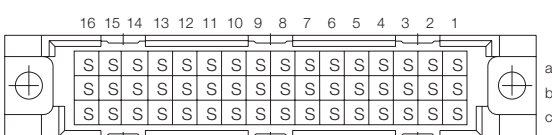
No. of Pins	Termination	Term. Length	Pin Dimensions	Class	Pressfit Zone	Part Number
						
32	Pressfit	6 mm	0.6 x 0.6 mm	2	–	284272
						
48	Pressfit	6 mm	0.6 x 0.6 mm	1	–	354406
48	Pressfit	6 mm	0.6 x 0.6 mm	2	–	354382
48	Pressfit w. Transfer Zone	13 mm	0.6 x 0.6 mm	1	–	354397
48	Pressfit	20 mm	0.6 x 0.6 mm	2	–	354384
						
32	Solder	4 mm	0.6 x 0.6 mm	2	–	004485
						
48	Solder	4 mm	0.6 x 0.6 mm	2	–	004484
48	Solder with Clip	4 mm	0.6 x 0.6 mm	2	–	063277
48	Solder	13 mm	0.6 x 0.6 mm	2	–	424201
						
48	THR	2.5 mm	0.6 x 0.6 mm	2	–	154964
48	THR with Clip	2.5 mm	0.6 x 0.6 mm	2	–	144710
88						

DIN 41612 / IEC 60603-2 Connectors

Type R/3 Male



Dimensional Drawing Pressfit

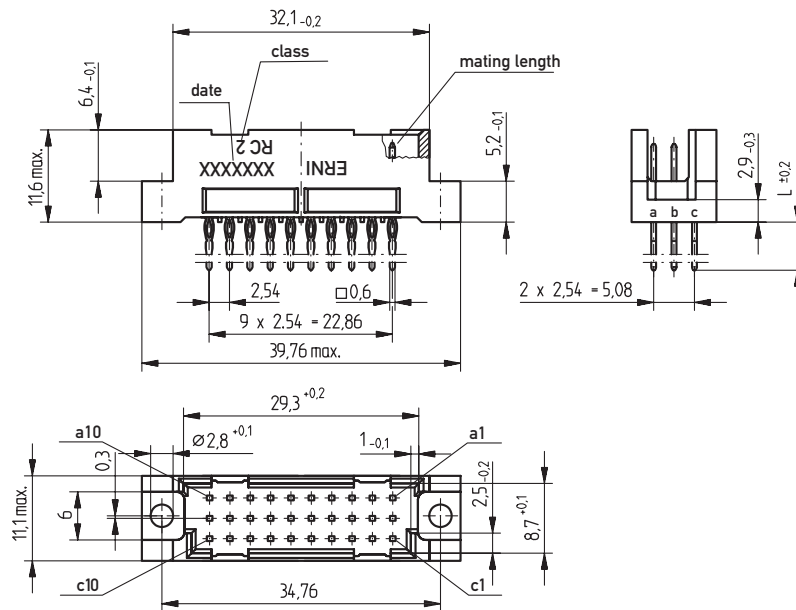

PCB drillhole pattern

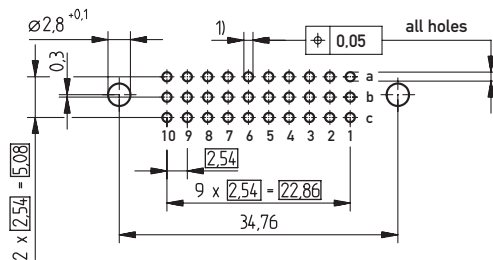

- 1) $\phi 1.0 \pm 0.009$ Diameter of finished plated-through hole
- $\phi 1.15 \pm 0.025$ Diameter of drilled hole

DIN 41612 / IEC 60603-2 Connectors

Type R/3 Male



Dimensional Drawing Solder

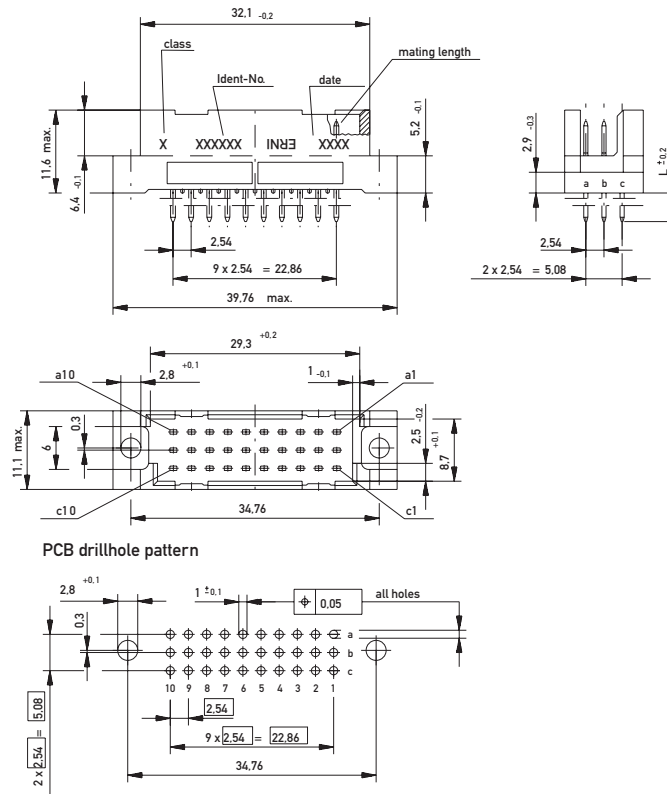

Dimensional Drawing THR

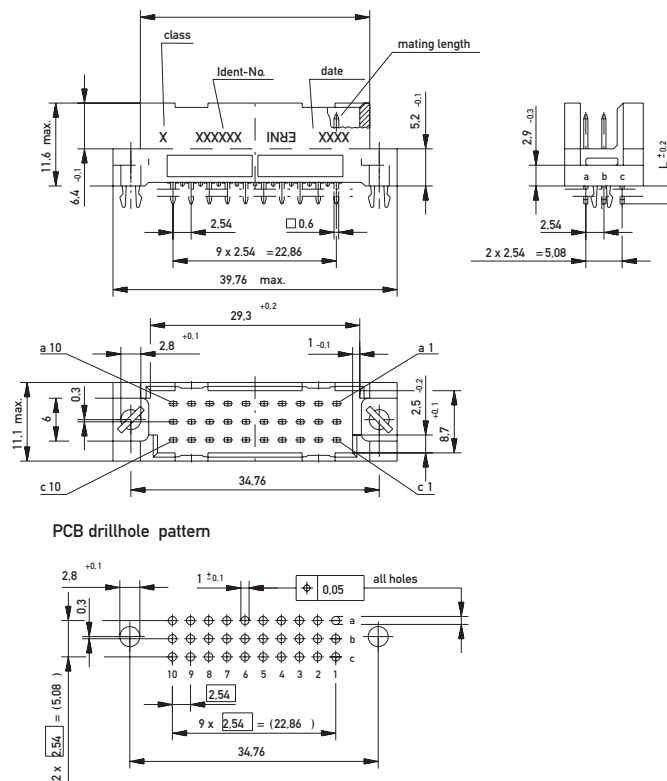

DIN 41612 / IEC 60603-2 Connectors

Type R/3 Male



Ordering Information

No. of Pins	Termination	Term. Length	Pin Dimensions	Class	Pressfit Zone	Part Number
30	Pressfit	6 mm	0.6 x 0.6 mm	2	–	354383
30	Pressfit w. Transfer Zone	20 mm	0.6 x 0.6 mm	2	–	354388
30	Solder	4 mm	0.6 x 0.6 mm	2	–	004500
30	Solder	13 mm	0.6 x 0.6 mm	2	–	424195
30	THR with Clip	2.5 mm	0.6 x 0.6 mm	2	–	144708

DIN 41612 / IEC 60603-2 Connectors

Type R Female



Dimensional Drawing Pressfit

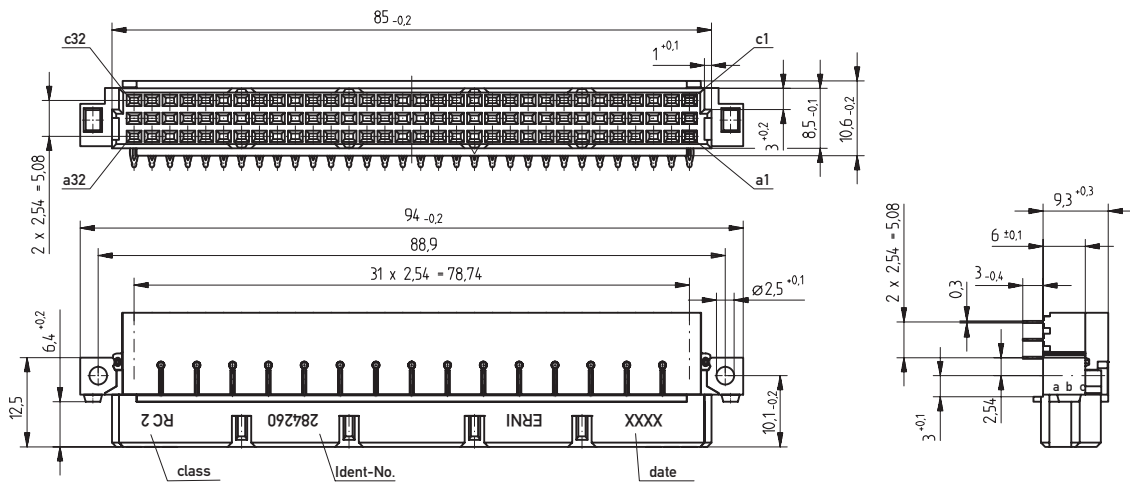

PCB drillhole pattern

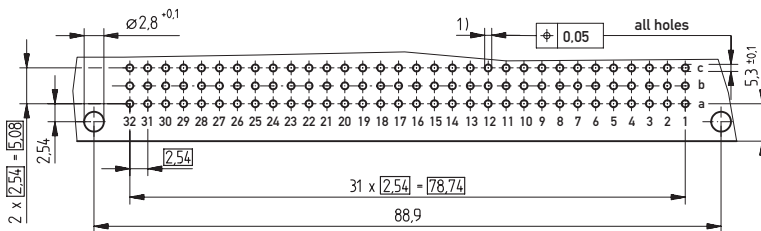

- 1) $\phi 1.0^{+0.006}$ Diameter of finished plated-through hole
- $\phi 1.15^{+0.025}$ Diameter of drilled hole

DIN 41612 / IEC 60603-2 Connectors

Type R Female



Dimensional Drawing Solder

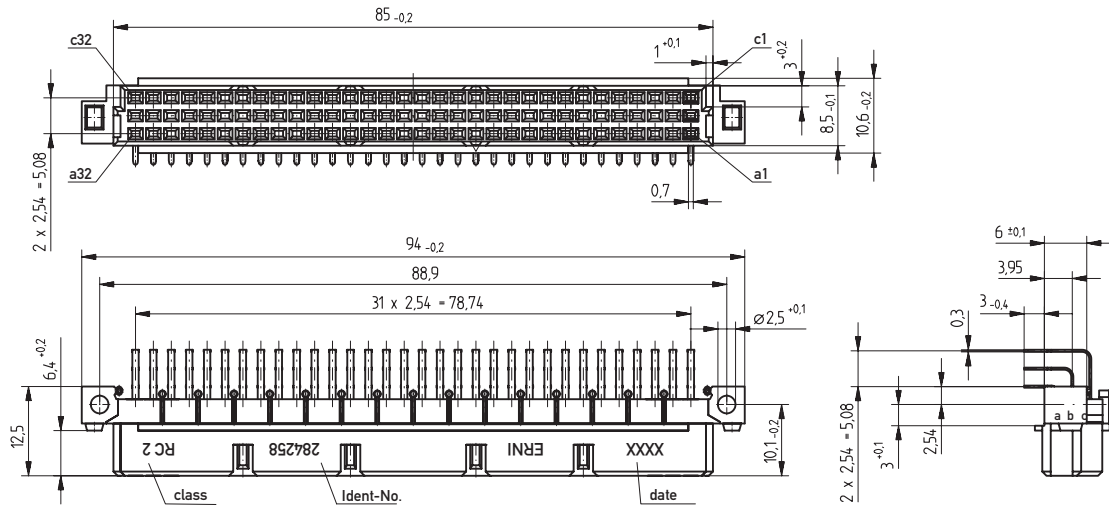

PCB drillhole pattern

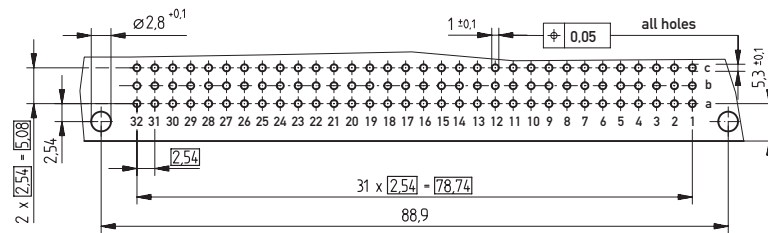

Dimensional Drawing THR

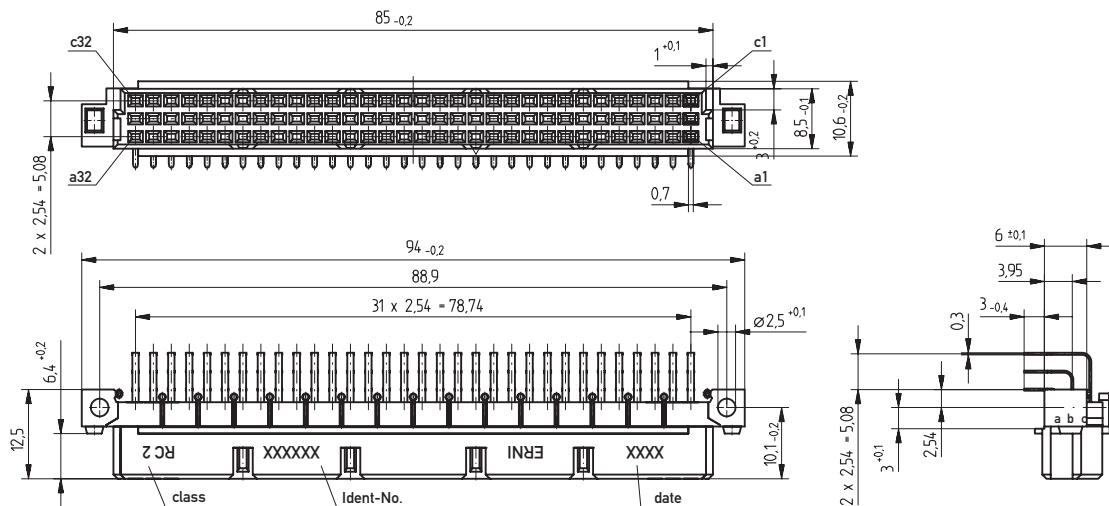

PCB drillhole pattern

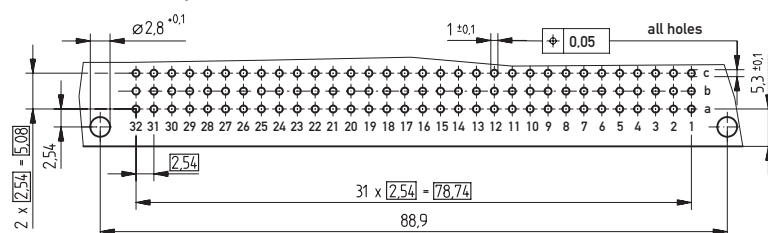





DIN 41612 / IEC 60603-2 Connectors

Type R Female

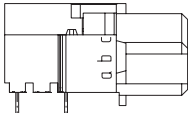
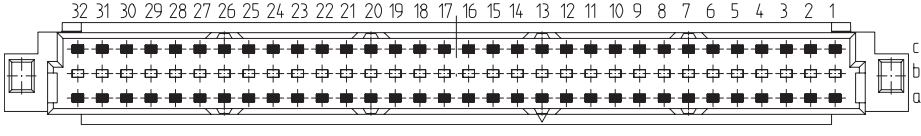
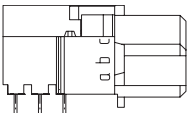
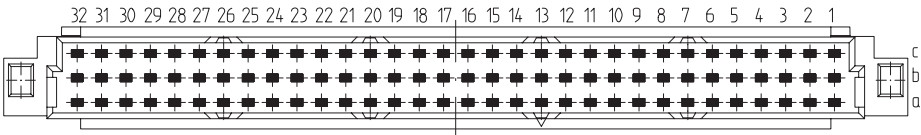
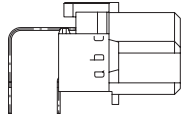
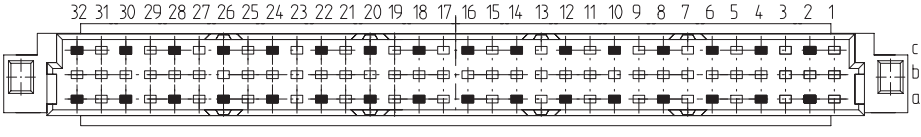
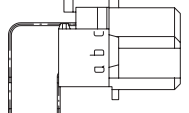
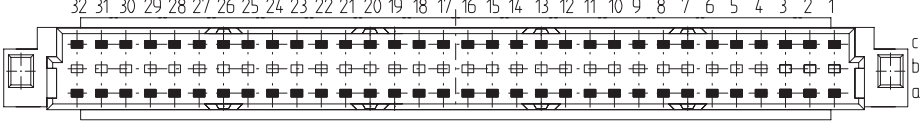

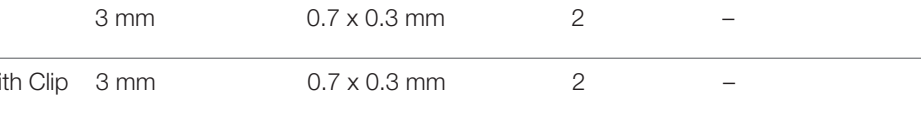
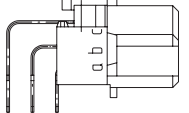
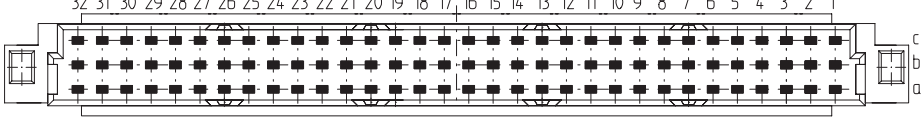
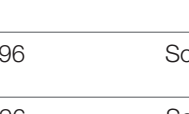
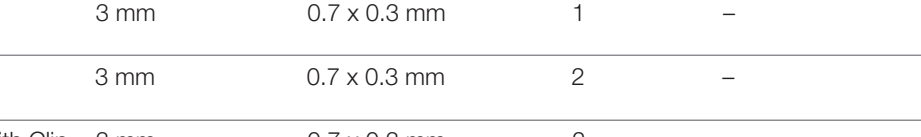
Ordering Information

No. of Pins	Termination	Term. Length	Pin Dimensions	Class	Pressfit Zone	Part Number
 	Pressfit	3 mm	0.7 x 0.3 mm	2	–	284262
 	Pressfit	3 mm	0.7 x 0.3 mm	2	–	284260
 	Solder	3 mm	0.7 x 0.3 mm	2	–	284261
 	Solder	3 mm	0.7 x 0.3 mm	2	–	284259
 	Solder with Clip	3 mm	0.7 x 0.3 mm	2	–	284263
 	Solder	3 mm	0.7 x 0.3 mm	1	–	354135
 	Solder	3 mm	0.7 x 0.3 mm	2	–	284258
 	Solder with Clip	3 mm	0.7 x 0.3 mm	2	–	284264

DIN 41612 / IEC 60603-2 Connectors

Type R Female



Ordering Information

No. of Pins	Termination	Term. Length	Pin Dimensions	Class	Pressfit Zone	Part Number
64	THR	3 mm	0.7 x 0.3 mm	2	–	284270
64	THR with Clip	3 mm	0.7 x 0.3 mm	2	–	284653
96	THR	3 mm	0.7 x 0.3 mm	2	–	244139
96	THR with Clip	3 mm	0.7 x 0.3 mm	2	–	284269

DIN 41612 / IEC 60603-2 Connectors

Type R/2 Female



Dimensional Drawing Solder

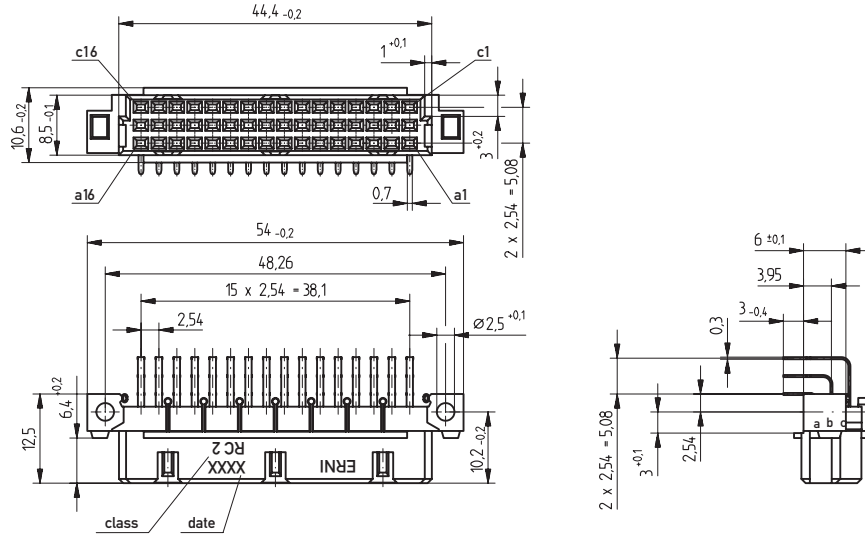

PCB drillhole pattern

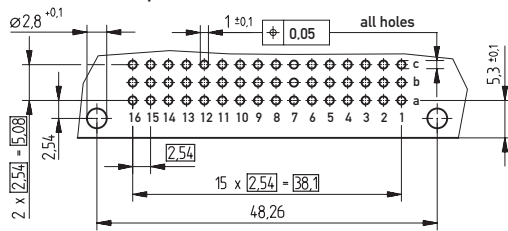

Dimensional Drawing THR

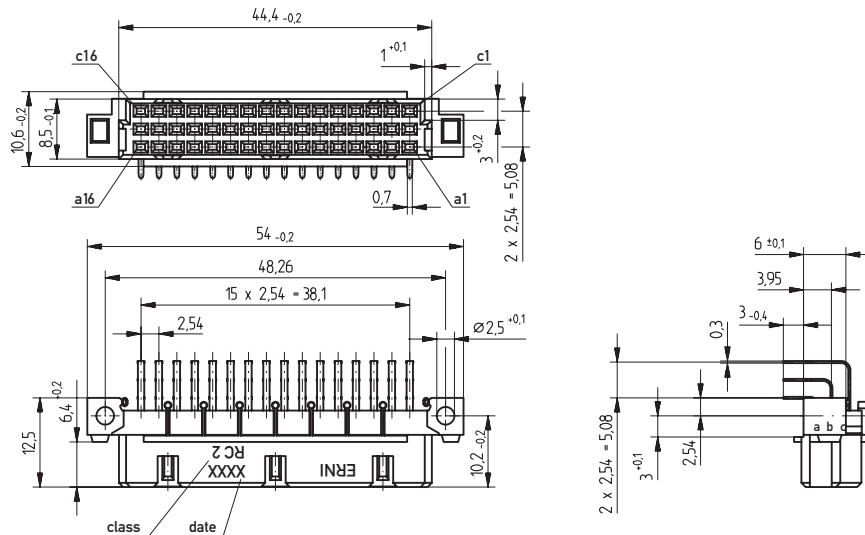

PCB drillhole pattern

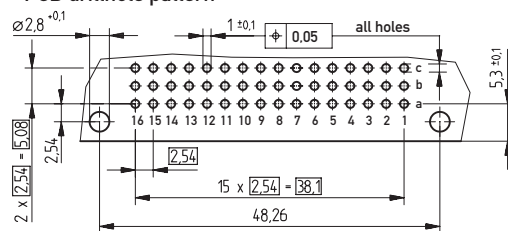

DIN 41612 / IEC 60603-2 Connectors

Type R/2 Female

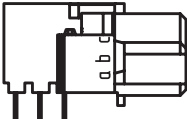
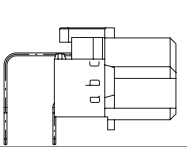
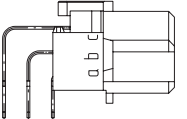
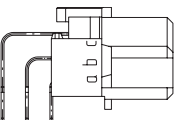
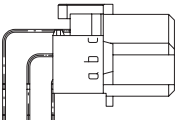
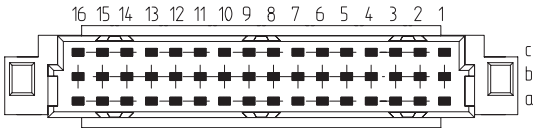
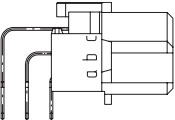
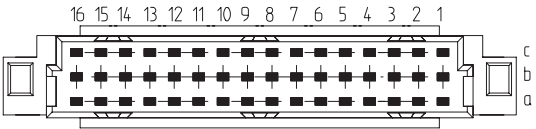

Ordering Information

No. of Pins	Termination	Term. Length	Pin Dimensions	Class	Pressfit Zone	Part Number
						
48	Pressfit	3 mm	0.7 x 0.3 mm	2	–	354159
						
32	Solder	3 mm	0.7 x 0.3 mm	2	–	284324
						
48	Solder	3 mm	0.7 x 0.3 mm	1	–	354251
48	Solder	3 mm	0.7 x 0.3 mm	2	–	284325
						
48	THR	3 mm	0.7 x 0.3 mm	2	–	354134
48	THR with Clip	3 mm	0.7 x 0.3 mm	2	–	354220

DIN 41612 / IEC 60603-2 Connectors

Type R/3 Female



Dimensional Drawing Pressfit

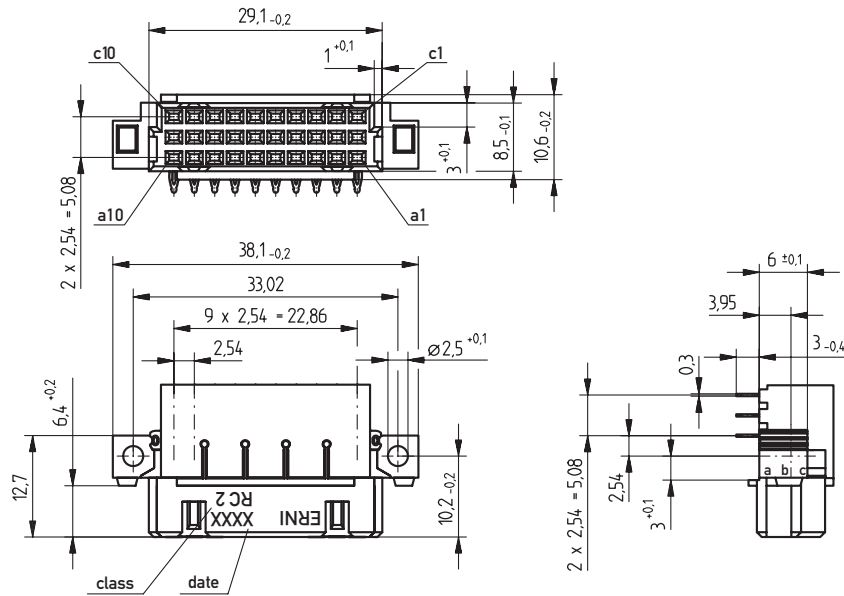

PCB drillhole pattern

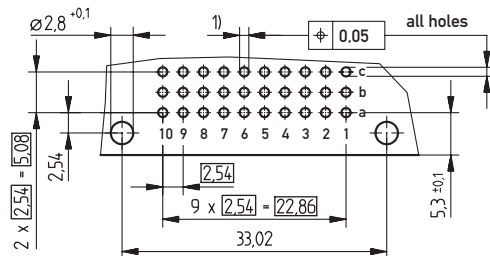

- 1) $\varnothing 1,0_{+0,09}^{-0,06}$ Diameter of finished plated-through hole
- $\varnothing 1,15_{\pm 0,025}$ Diameter of drilled hole

DIN 41612 / IEC 60603-2 Connectors

Type R/3 Female



Dimensional Drawing Solder

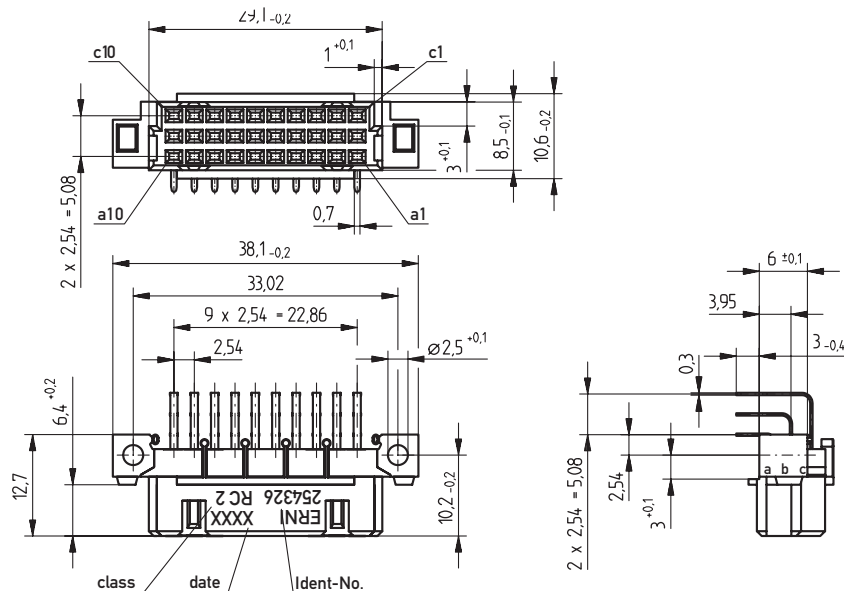

PCB drillhole pattern

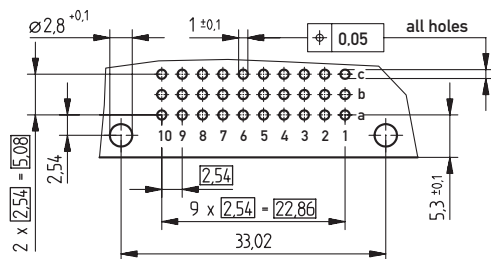

DIN 41612 / IEC 60603-2 Connectors

Type R/3 Female

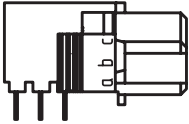
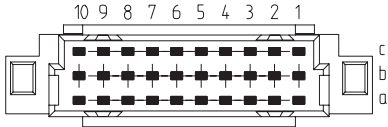
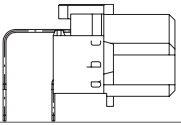
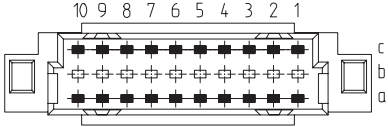
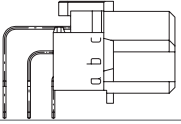
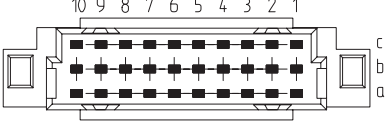
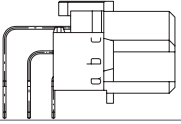
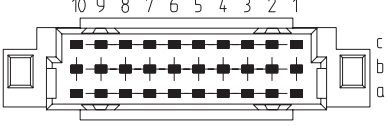

Ordering Information

No. of Pins	Termination	Term. Length	Pin Dimensions	Class	Pressfit Zone	Part Number
	Pressfit	3 mm		2	–	294863
	Solder	3 mm		2	–	284419
	Solder	3 mm		1	–	294716
	Solder	3 mm		2	–	254326

DIN 41612 / IEC 60603-2 Connectors

Type CD Male

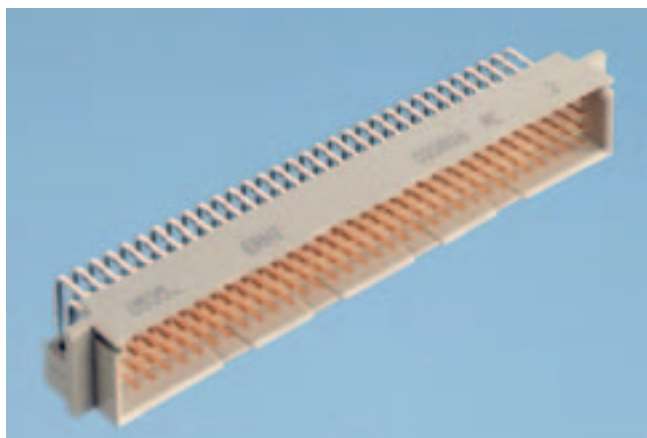

Dimensional Drawing Pressfit

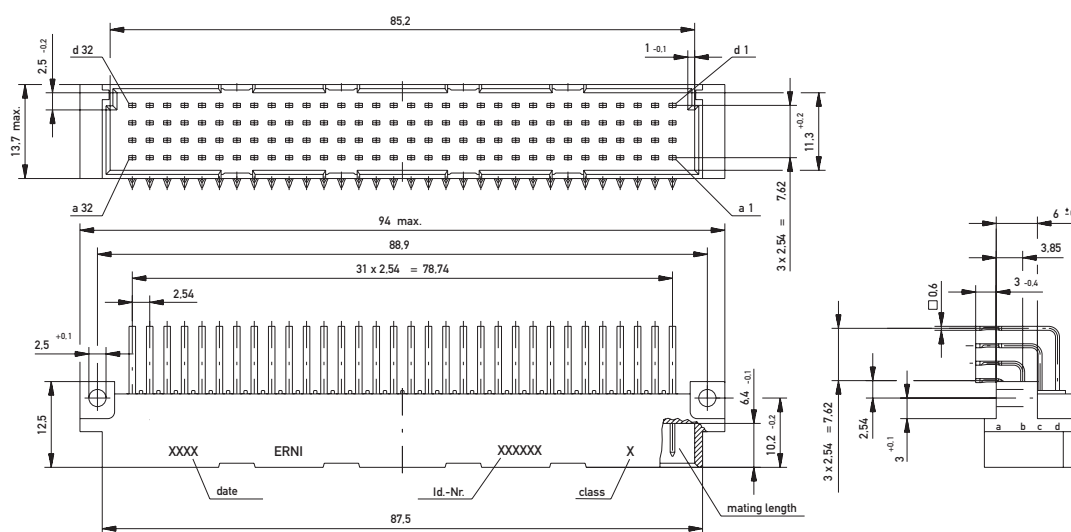

PCB drillhole pattern

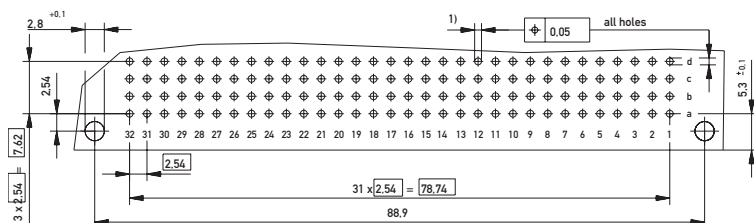

- 1) $\varnothing 1.0 \begin{smallmatrix} +0.09 \\ -0.06 \end{smallmatrix}$ Diameter of finished plated-through hole
- $\varnothing 1.15 \pm 0.025$ Diameter of drilled hole

Dimensional Drawing Solder

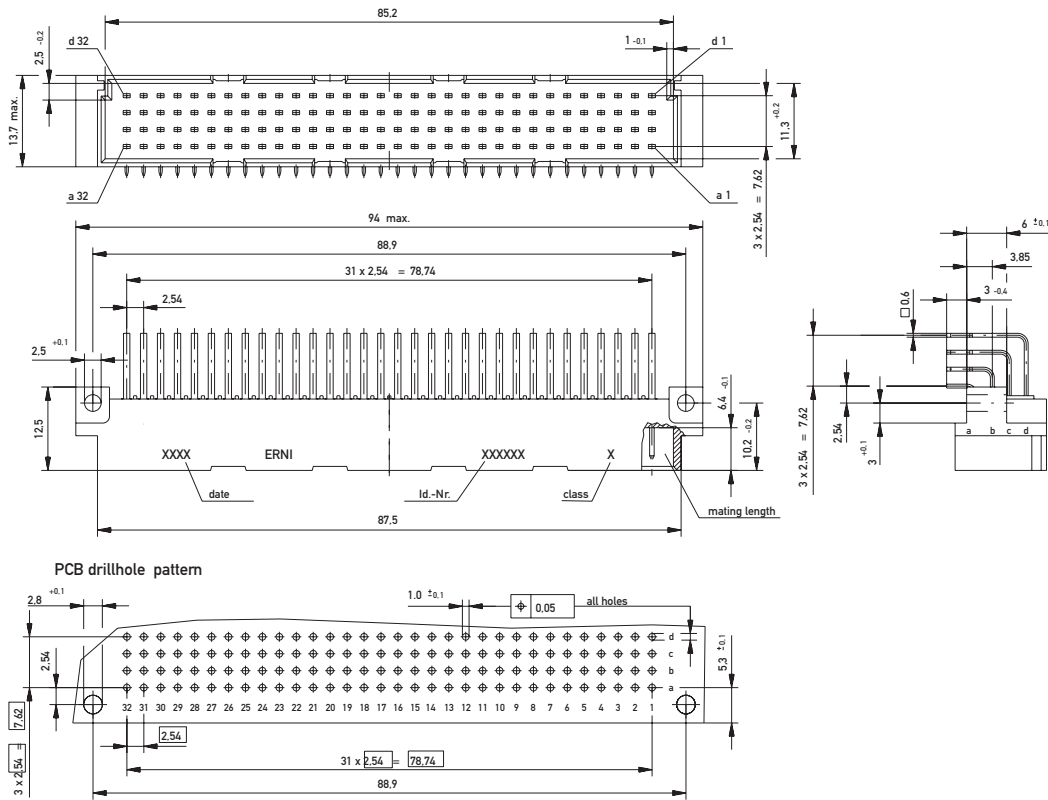

Dimensional Drawing THR

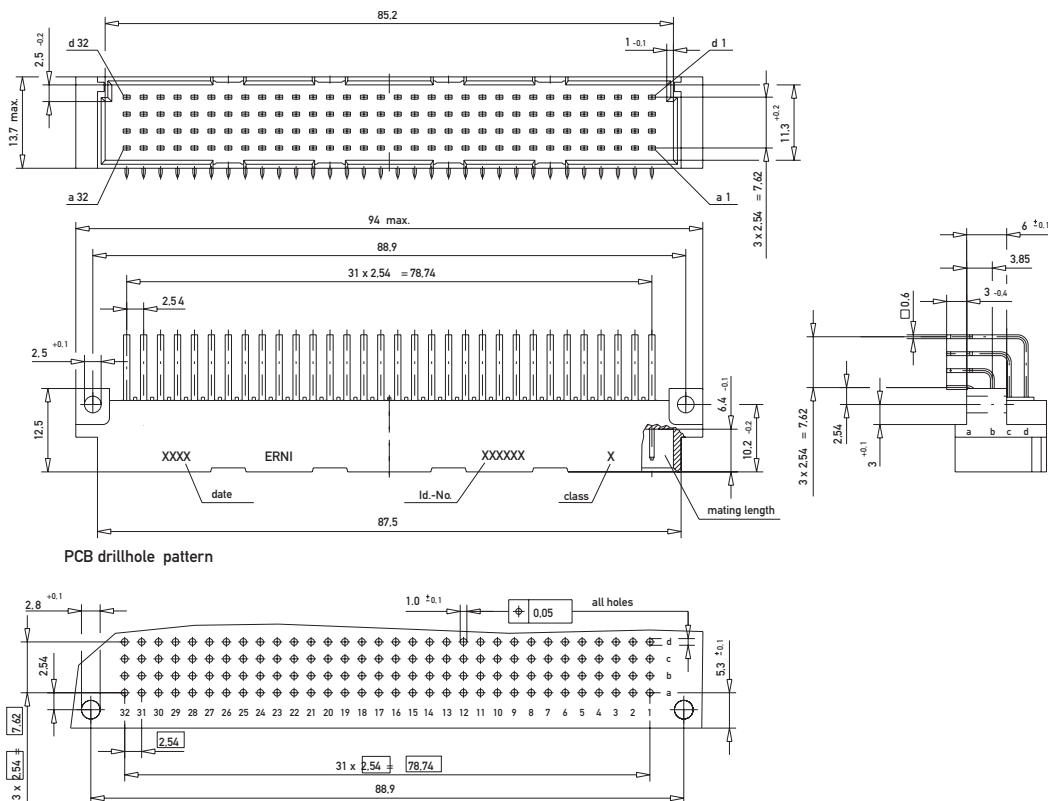

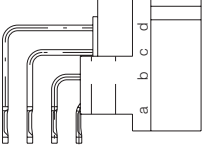
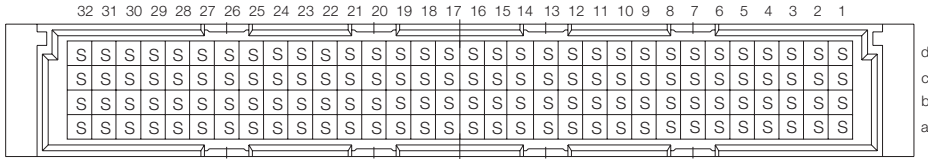
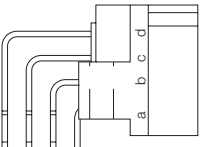
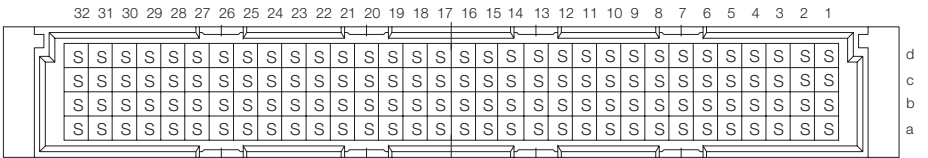
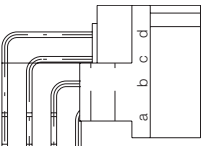
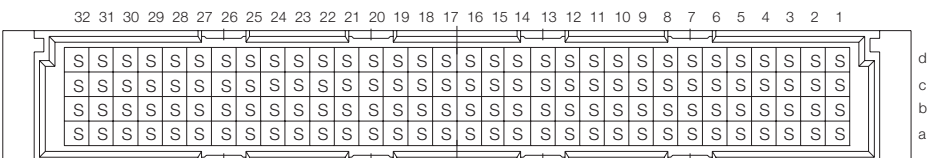

Ordering Information

No. of Pins	Termination	Term. Length	Pin Dimensions	Class	Pressfit Zone	Part Number
	Pressfit	3 mm		2	1.5 mm	033436
	Solder	3 mm		1	-	033298
128	Solder	3 mm	0.6 x 0.6 mm	2	-	023816
128	Solder with Clip	3 mm	0.6 x 0.6 mm	2	-	913767
	THR	3 mm		2	-	144713
128	THR with Clip	3 mm	0.6 x 0.6 mm	2	-	154959

DIN 41612 / IEC 60603-2 Connectors

Type CD Female

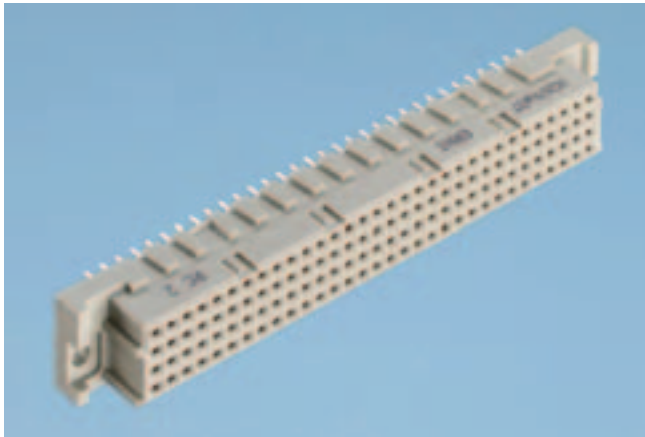

Dimensional Drawing Pressfit

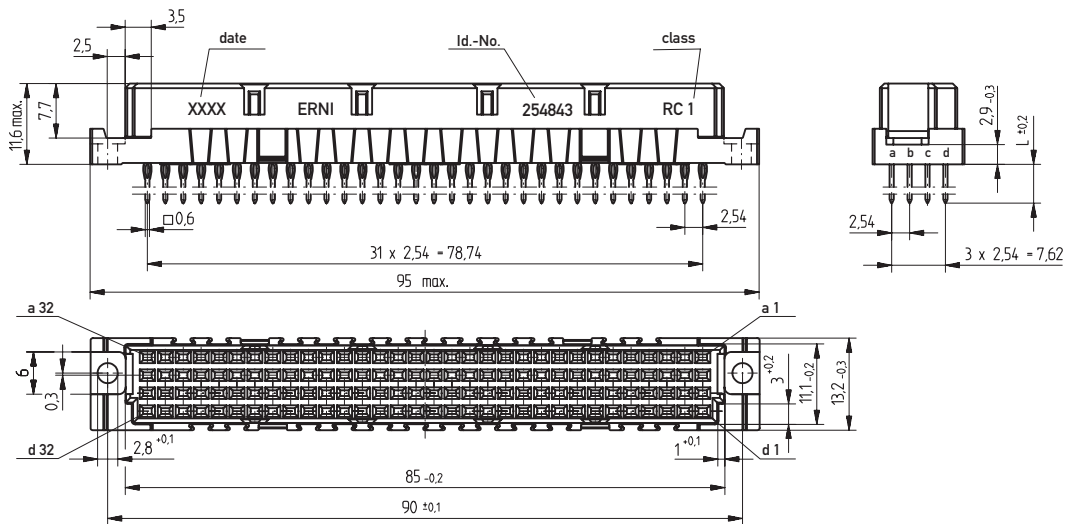

PCB drillhole pattern

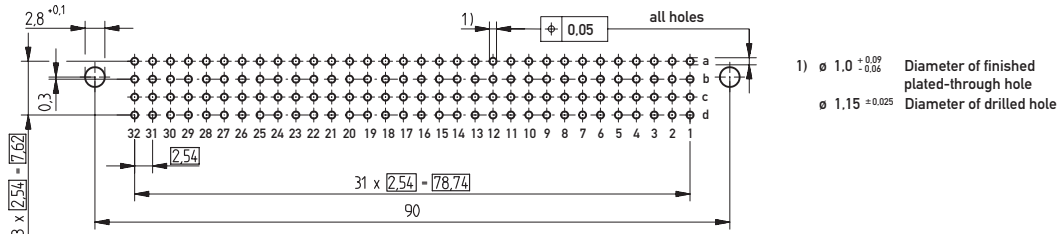

DIN 41612 / IEC 60603-2 Connectors

Type CD Female



Dimensional Drawing Solder

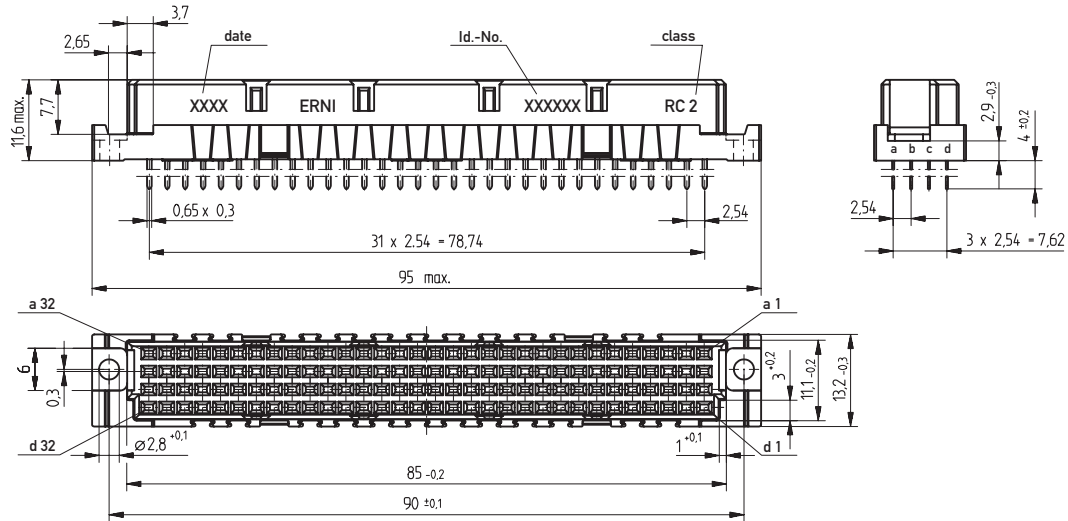

PCB drillhole pattern

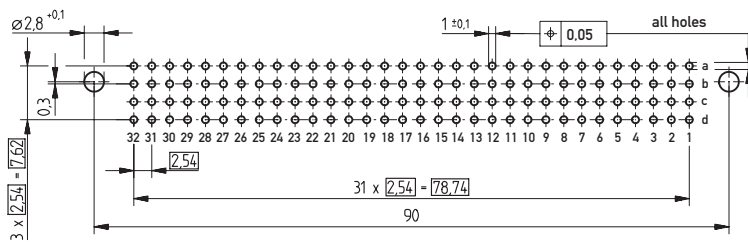

Dimensional Drawing THR

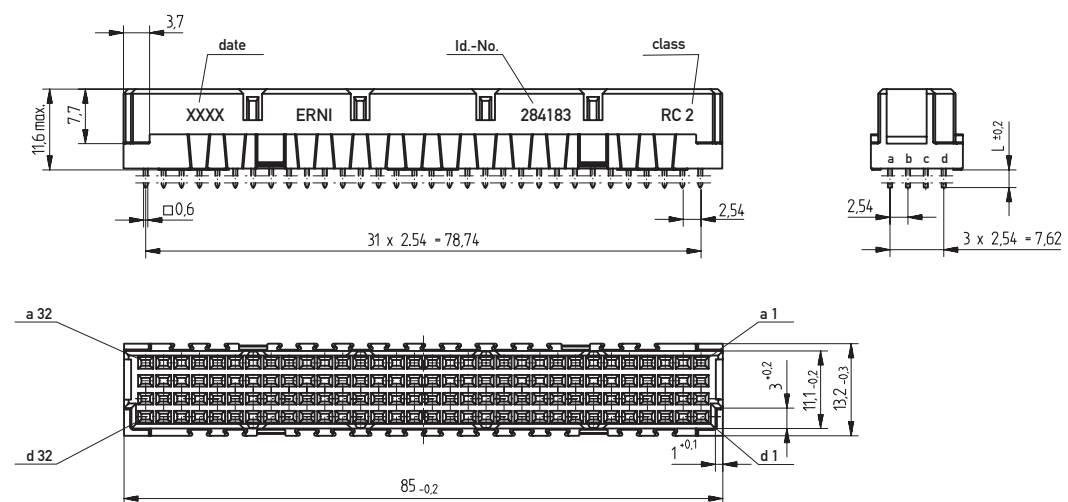

PCB drillhole pattern

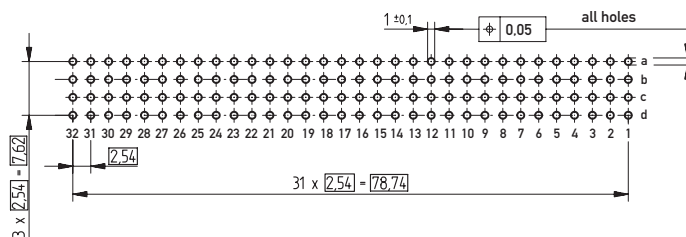

DIN 41612 / IEC 60603-2 Connectors

Type CD Female



Ordering Information

No. of Pins	Termination	Term. Length	Pin Dimensions	Class	Pressfit Zone	Part Number
	Pressfit	4 mm	0.8 x 0.3 mm	2	–	254118
	Pressfit	5.5 mm	0.6 x 0.6 mm	1	–	254843
	Pressfit	5.5 mm	0.6 x 0.6 mm	2	–	244999
	Pressfit w/o Flange	5.5 mm	0.6 x 0.6 mm	2	–	254844
	Pressfit w. Transfer Zone	13 mm	0.6 x 0.6 mm	2	2.5 mm	254979
	Pressfit w. Transfer Zone	17 mm	0.6 x 0.6 mm	2	2.5 mm	284181
		Solder	3.7 mm	0.65 x 0.3 mm	1	–
Solder		3.7 mm	0.65 x 0.3 mm	2	–	254977
Solder w/o Flange		3.7 mm	0.65 x 0.3 mm	2	–	284180
Solder with Clip		3.7 mm	0.65 x 0.3 mm	2	–	254978
Solder w. kinked Legs		4.5 mm	0.8 x 0.3 mm	2	–	284951
		THR w/o Flange	2.5 mm	0.6 x 0.6 mm	2	–

DIN 41612 / IEC 60603-2 Connectors

Type RD Male



Dimensional Drawing Pressfit

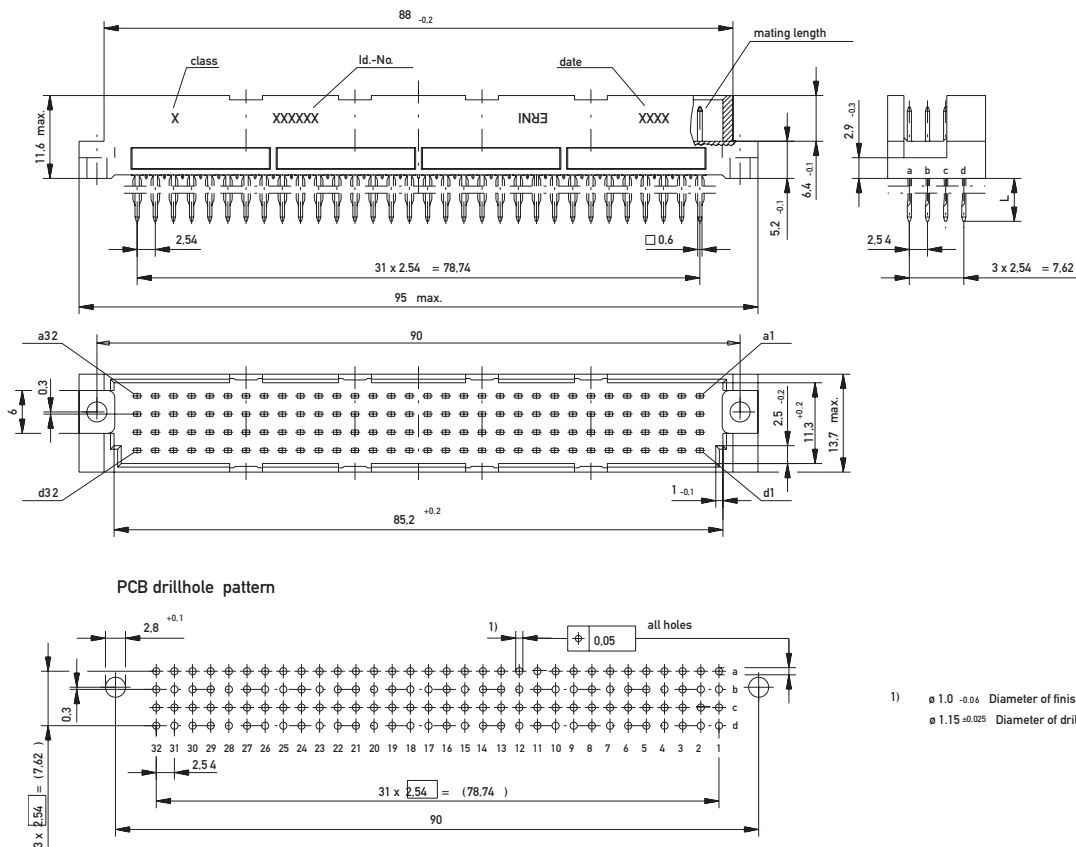

DIN 41612 / IEC 60603-2 Connectors

Type RD Male



Dimensional Drawing Solder

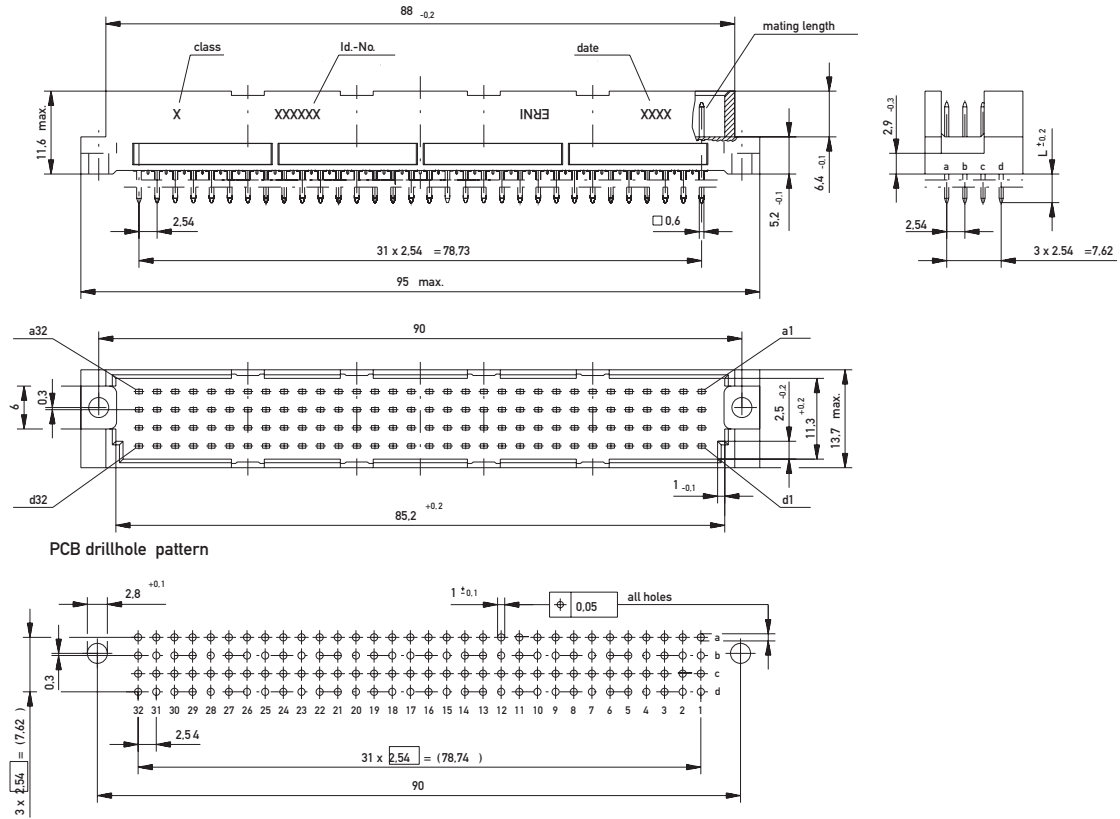

Dimensional Drawing THR

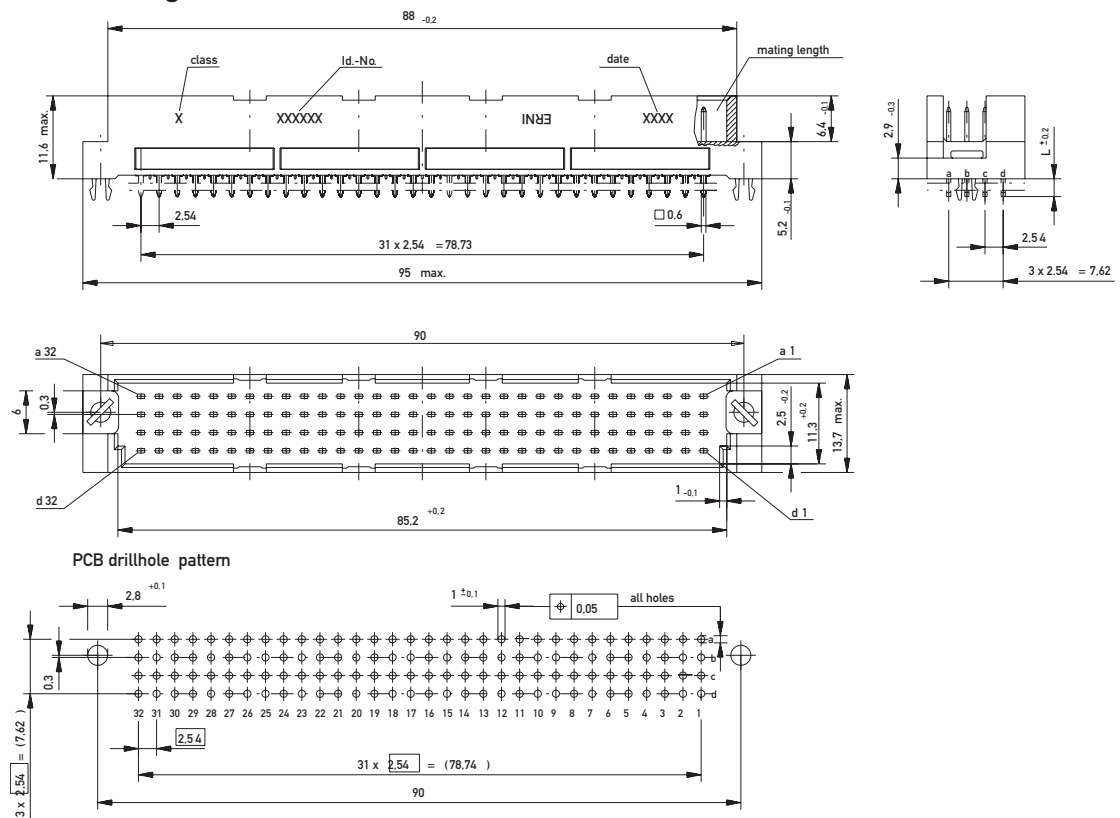

DIN 41612 / IEC 60603-2 Connectors

Type RD Male



Ordering Information

No. of Pins	Termination	Term. Length	Pin Dimensions	Class	Pressfit Zone	Part Number
128	Pressfit	6 mm	0.6 x 0.6 mm	2	2.5 mm	013178
128	Pressfit w. Transfer Zone	20 mm	0.6 x 0.6 mm	2	2.5 mm	013154
128	Solder	4 mm	0.6 x 0.6 mm	1	–	013171
128	Solder	4 mm	0.6 x 0.6 mm	2	–	013172
128	Solder	13 mm	0.6 x 0.6 mm	1	–	013174
128	Solder	13 mm	0.6 x 0.6 mm	2	–	013175
128	THR with Clip	2.5 mm	0.6 x 0.6 mm	2	–	154970

DIN 41612 / IEC 60603-2 Connectors

Type RD Female



Size RD 128 female connectors are provided with locating strip. This plastic component is attached to the extended mounting flanges and serves to guide the pins accurately. The extended mounting flanges have two mounting holes at a pitch of 5.08mm. The length of the mounting flanges provides improved support for the connector on the PC board.

Dimensional Drawing Pressfit

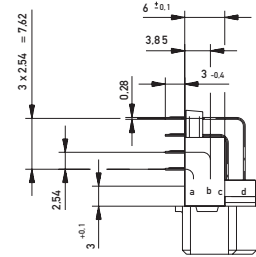
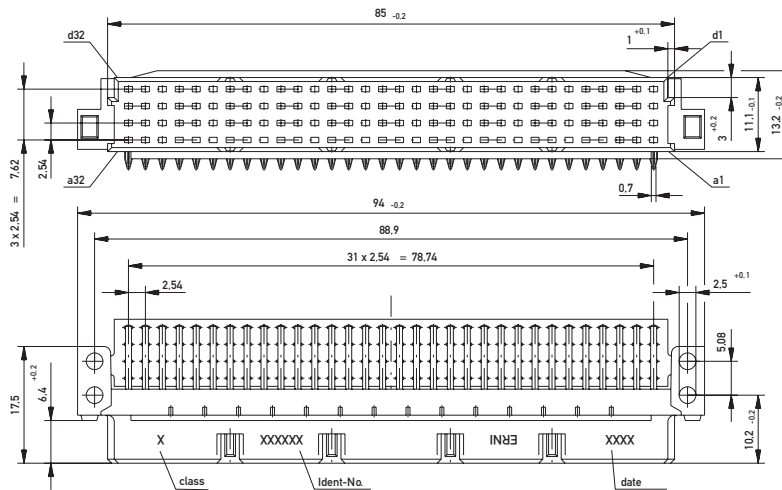

PCB drillhole pattern

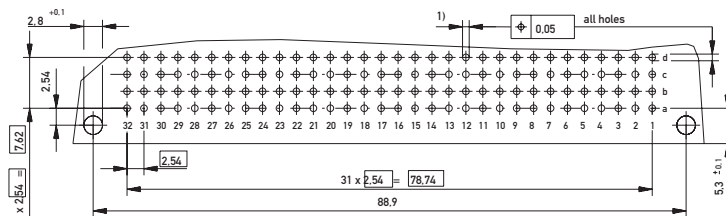

- 1) $\phi 1.0 - 0.06$ Diameter of finished plated-through hole
- $\phi 1.15 \pm 0.025$ Diameter of drilled hole

DIN 41612 / IEC 60603-2 Connectors

Type RD Female



Dimensional Drawing Solder

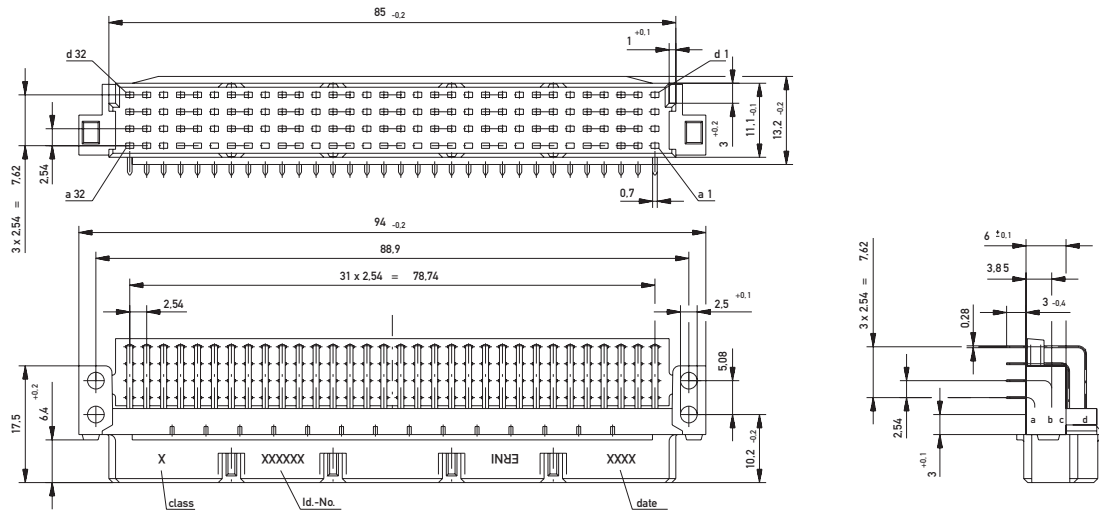

PCB drillhole pattern

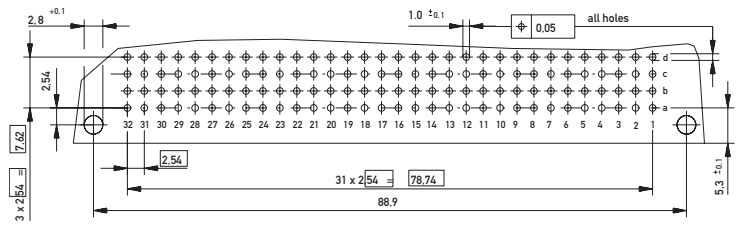

Dimensional Drawing THR

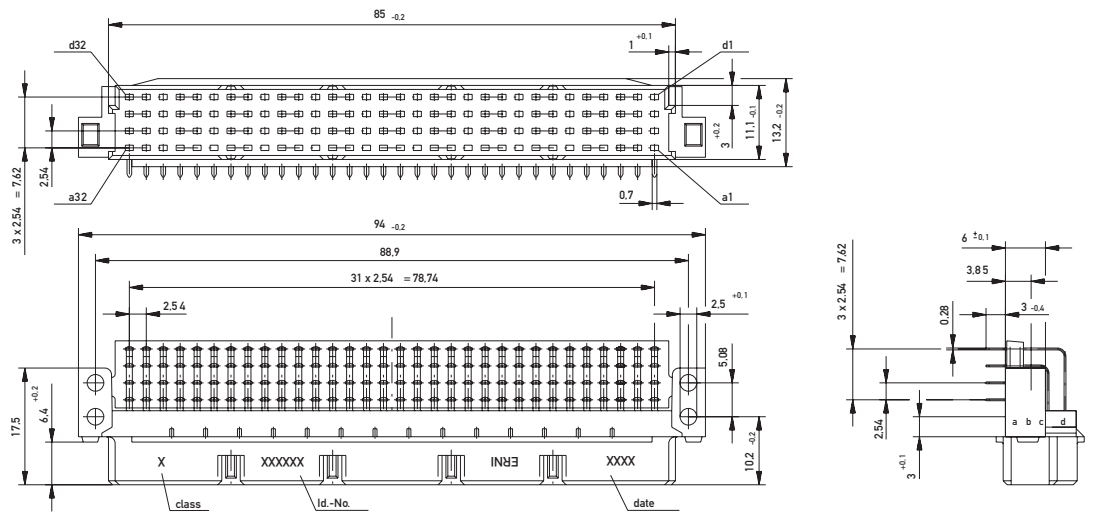

PCB drillhole pattern

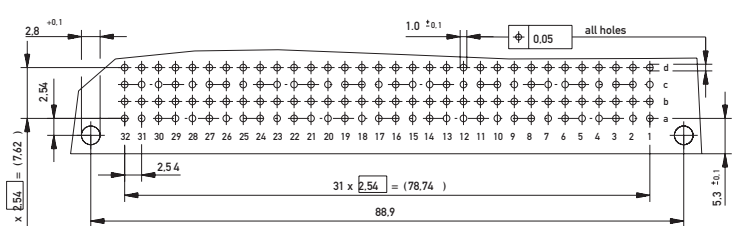



DIN 41612 / IEC 60603-2 Connectors

Type RD Female

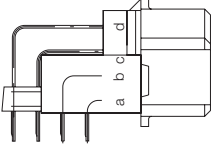
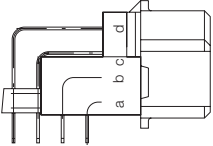

Ordering Information

No. of Pins	Termination	Term. Length	Pin Dimensions	Class	Pressfit Zone	Part Number
						
128	Pressfit	3 mm	0.28 x 0.7 mm	2	1 mm	013156
						
128	Solder	3 mm	0.28 x 0.7 mm	1	–	013183
128	Solder	3 mm	0.28 x 0.7 mm	2	–	013184
						
128	THR with Clip	3 mm	0.28 x 0.7 mm	2	–	154971

DIN 41612 / IEC 60603-2 Connectors

Type E 160 / E 80 Male

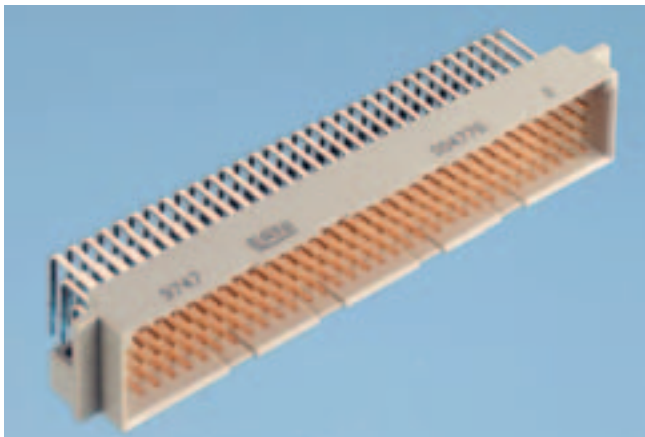

Dimensional Drawing Pressfit Type E 160

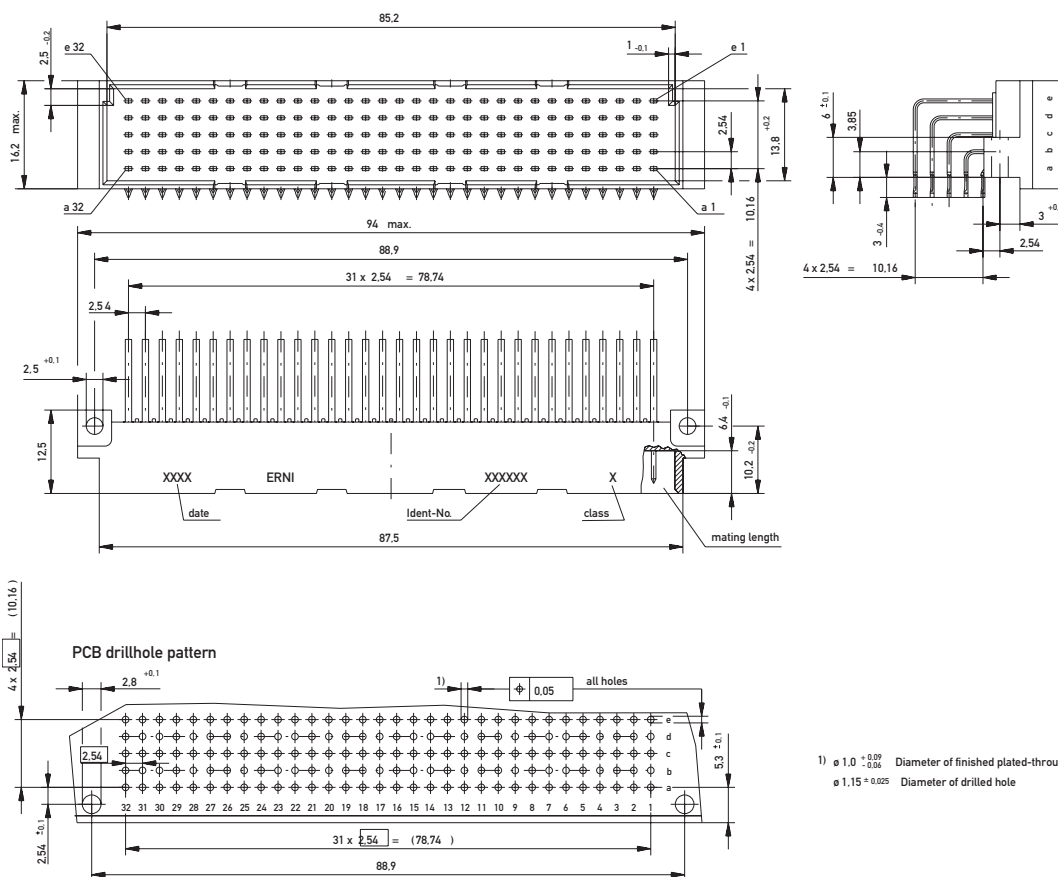

1) $\phi 1.0 \pm 0.09$ Diameter of finished plated-through hole
 $\phi 1.15 \pm 0.025$ Diameter of drilled hole

DIN 41612 / IEC 60603-2 Connectors

Type E 160 / E 80 Male



Dimensional Drawing Solder Type E 160

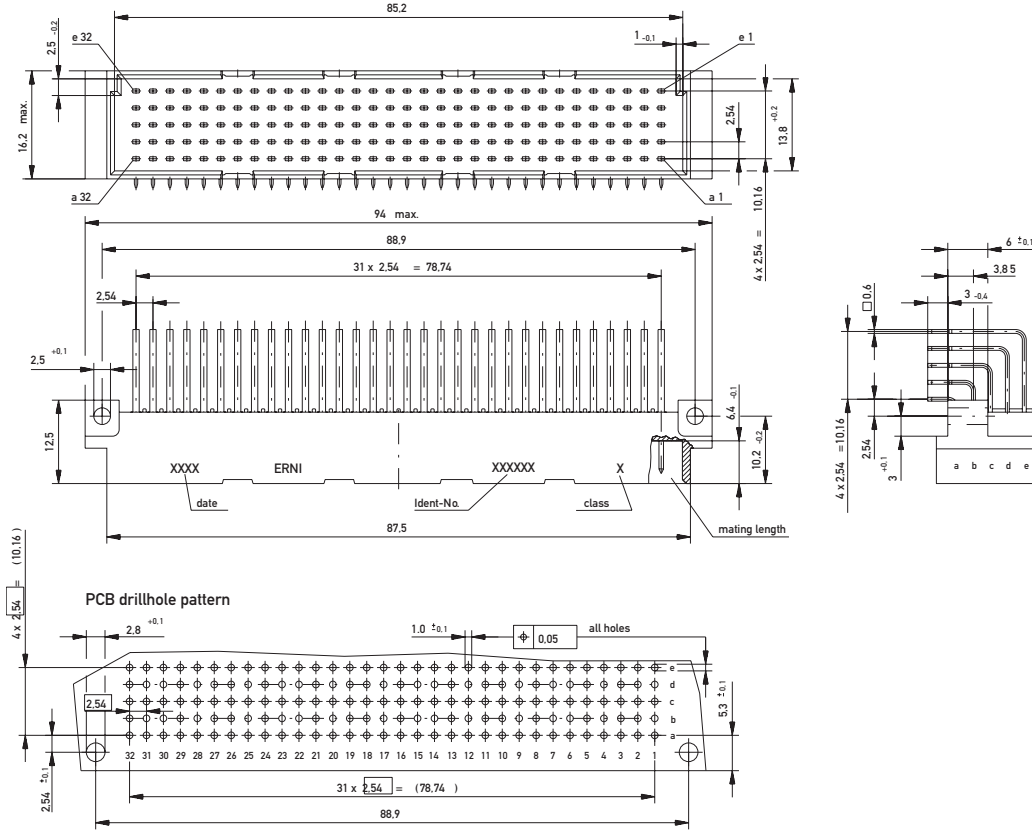

Dimensional Drawing Solder Type E 80

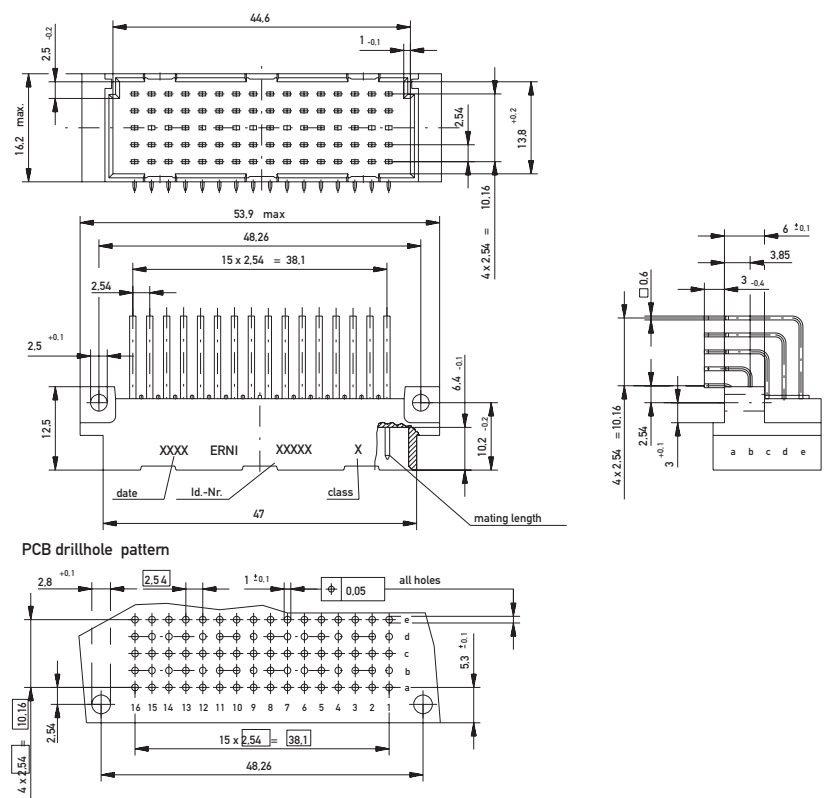

DIN 41612 / IEC 60603-2 Connectors

Type E 160 Male



Ordering Information

No. of Pins Termination Term. Length Pin Dimensions Class Pressfit Zone Part Number

160	Pressfit	3 mm	0.6 x 0.6 mm	2	1.5 mm	013096
-----	----------	------	--------------	---	--------	---------------

160	Solder	3 mm	0.6 x 0.6 mm	1	–	004777
-----	--------	------	--------------	---	---	---------------

160	Solder	3 mm	0.6 x 0.6 mm	2	–	004778
-----	--------	------	--------------	---	---	---------------

160	Solder with Clip	3 mm	0.6 x 0.6 mm	2	–	913615
-----	------------------	------	--------------	---	---	---------------

160	Solder	3.8 mm	0.6 x 0.6 mm	2	–	013058
-----	--------	--------	--------------	---	---	---------------

Type E 80 Male

80	Solder	3 mm	0.6 x 0.6 mm	2	–	033704
----	--------	------	--------------	---	---	---------------

DIN 41612 / IEC 60603-2 Connectors

Type E 160 Female



Dimensional Drawing Solder

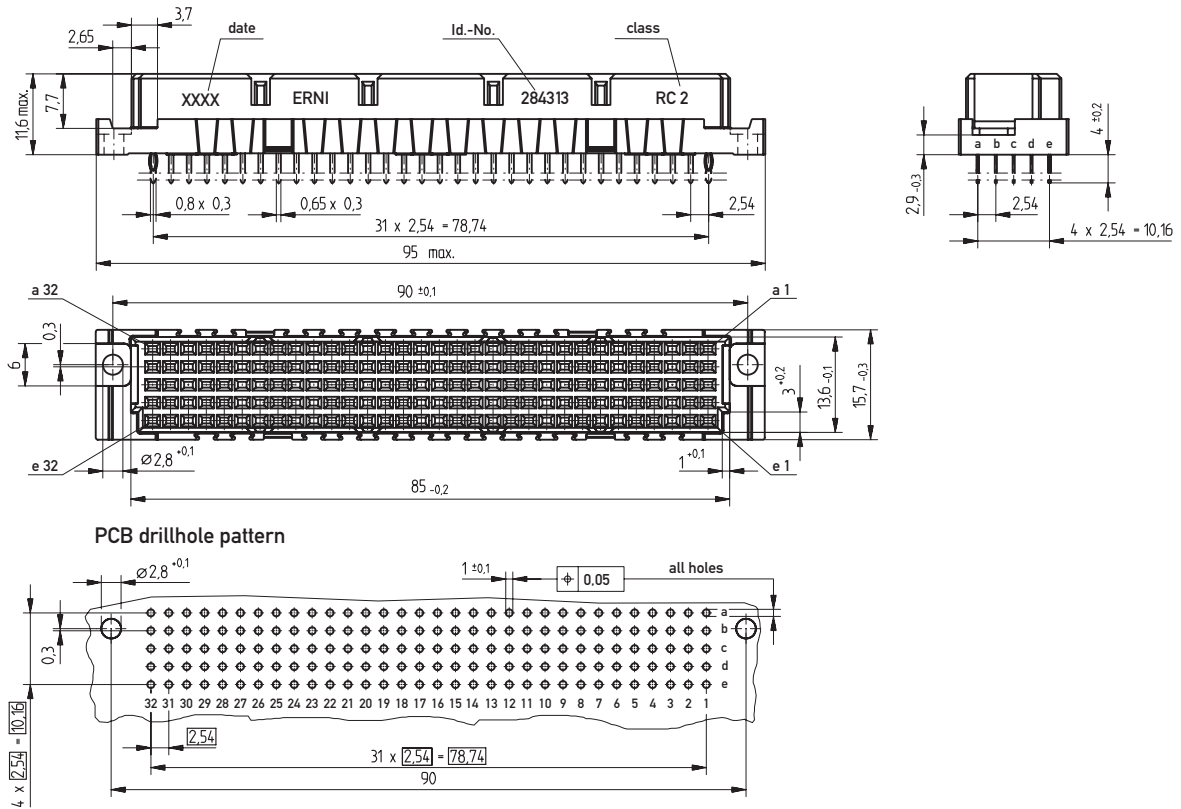

DIN 41612 / IEC 60603-2 Connectors

Type E 160 Female

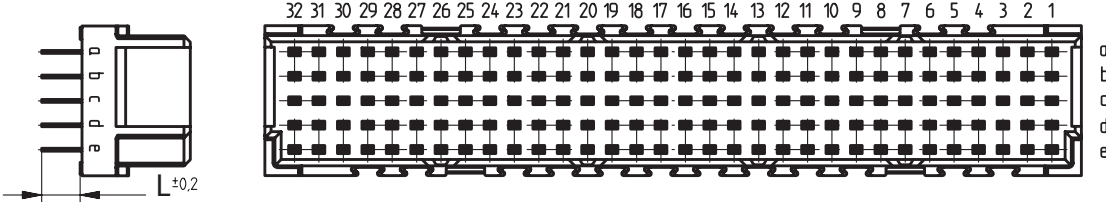
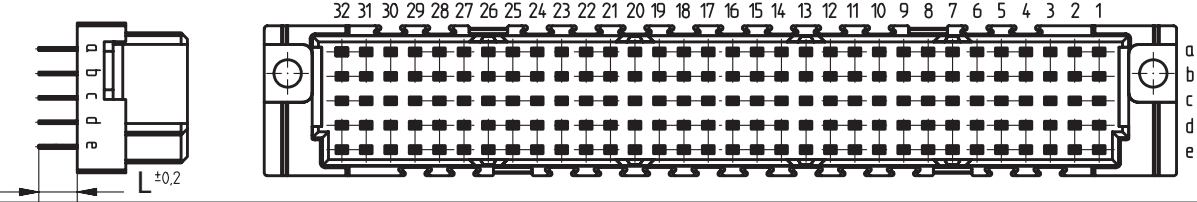

Ordering Information

No. of Pins	Termination	Term. Length	Pin Dimensions	Class	Pressfit Zone	Part Number
	Pressfit w/o Flange	4 mm	0.8 x 0.3 mm	2	2 mm	254124
160	Pressfit w. Transfer Zone	13 mm	0.6 x 0.6 mm	1	2.5 mm	284185
160	Pressfit w. Transfer Zone	13 mm	0.6 x 0.6 mm	2	2.5 mm	254975
160	Pressfit	17 mm	0.6 x 0.6 mm	2	2.5 mm	244672
160	Pressfit w. Transfer Zone	17 mm	0.6 x 0.6 mm	1	2.5 mm	284184
160	Pressfit w. Transfer Zone	17 mm	0.6 x 0.6 mm	2	2.5 mm	254960
	Solder w. retaining Loop	4 mm	0.8 x 0.3 mm	2	–	284313

DIN 41612 / IEC 60603-2 Connectors

Type TE Male

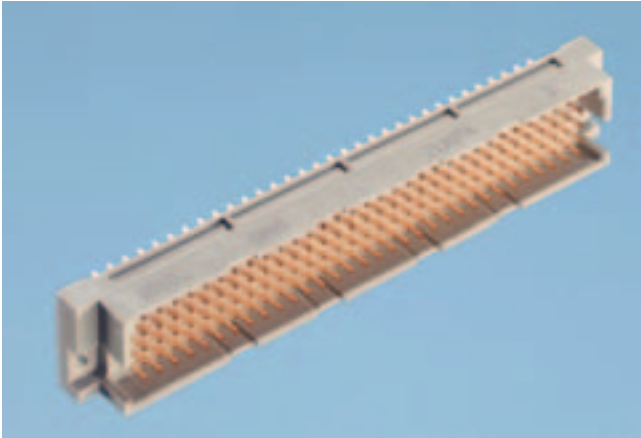

Dimensional Drawing Pressfit

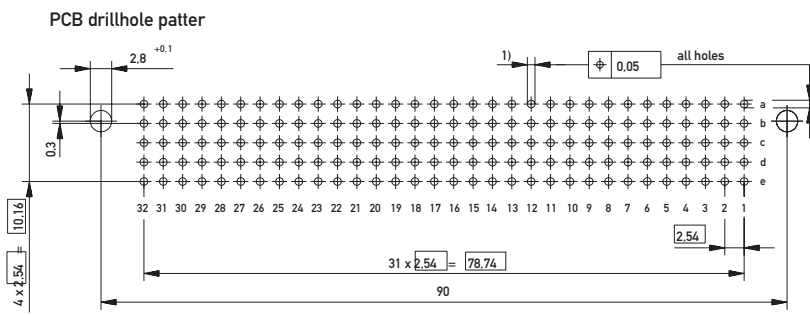
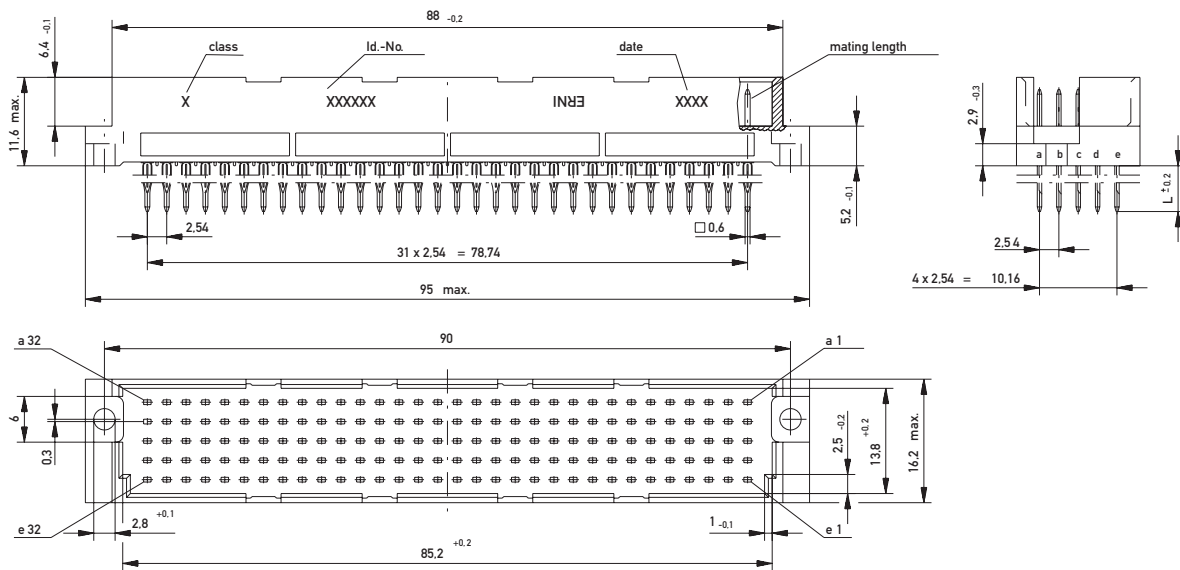

- 1) $\phi 1.0 \begin{smallmatrix} +0.09 \\ -0.06 \end{smallmatrix}$ Diameter of finished plated-through hole
- $\phi 1.15 \pm 0.025$ Diameter of drilled hole

DIN 41612 / IEC 60603-2 Connectors

Type TE Male



Dimensional Drawing Solder

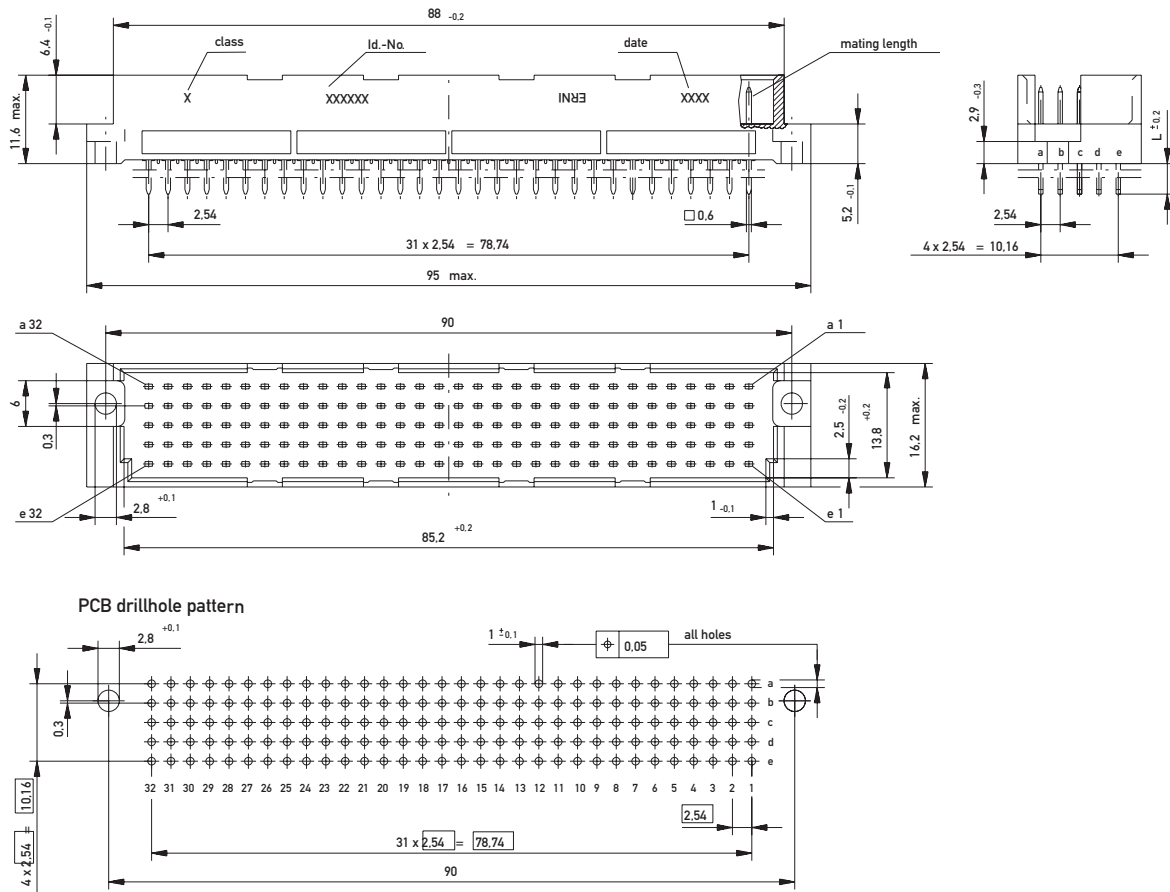

DIN 41612 / IEC 60603-2 Connectors

Type TE Male



Ordering Information

No. of Pins Termination Term. Length Pin Dimensions Class Pressfit Zone Part Number

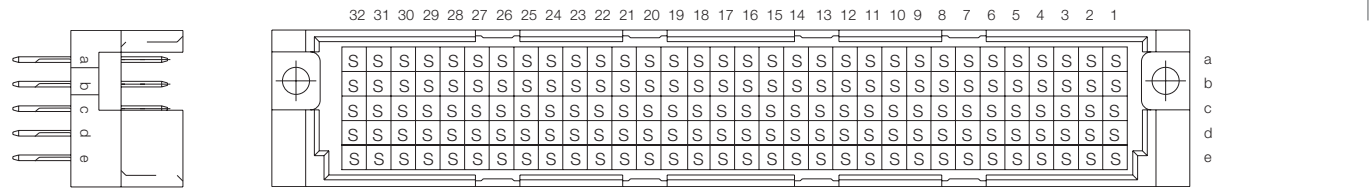

160	Pressfit	6 mm	0.6 x 0.6 mm	1	2.5 mm	013160
160	Pressfit	6 mm	0.6 x 0.6 mm	2	2.5 mm	013161
160	Pressfit	20 mm	0.6 x 0.6 mm	2	2.5 mm	013164
160	Pressfit w. Transfer Zone	20 mm	0.6 x 0.6 mm	2	2.5 mm	013155

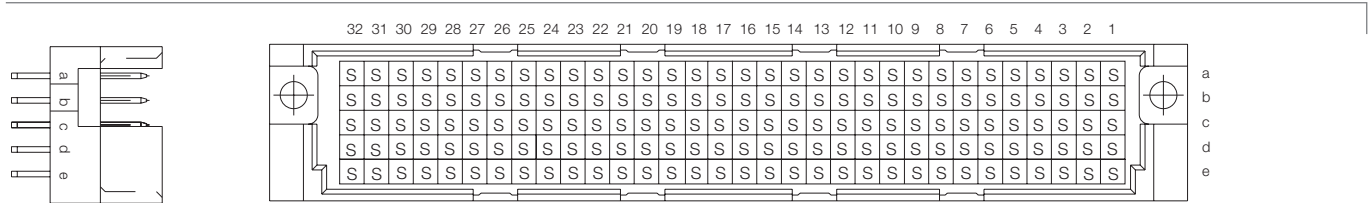

160	Solder	4 mm	0.6 x 0.6 mm	1	–	013073
160	Solder	4 mm	0.6 x 0.6 mm	2	–	013074
160	Solder	13 mm	0.6 x 0.6 mm	2	–	013071



Dimensional Drawing Solder

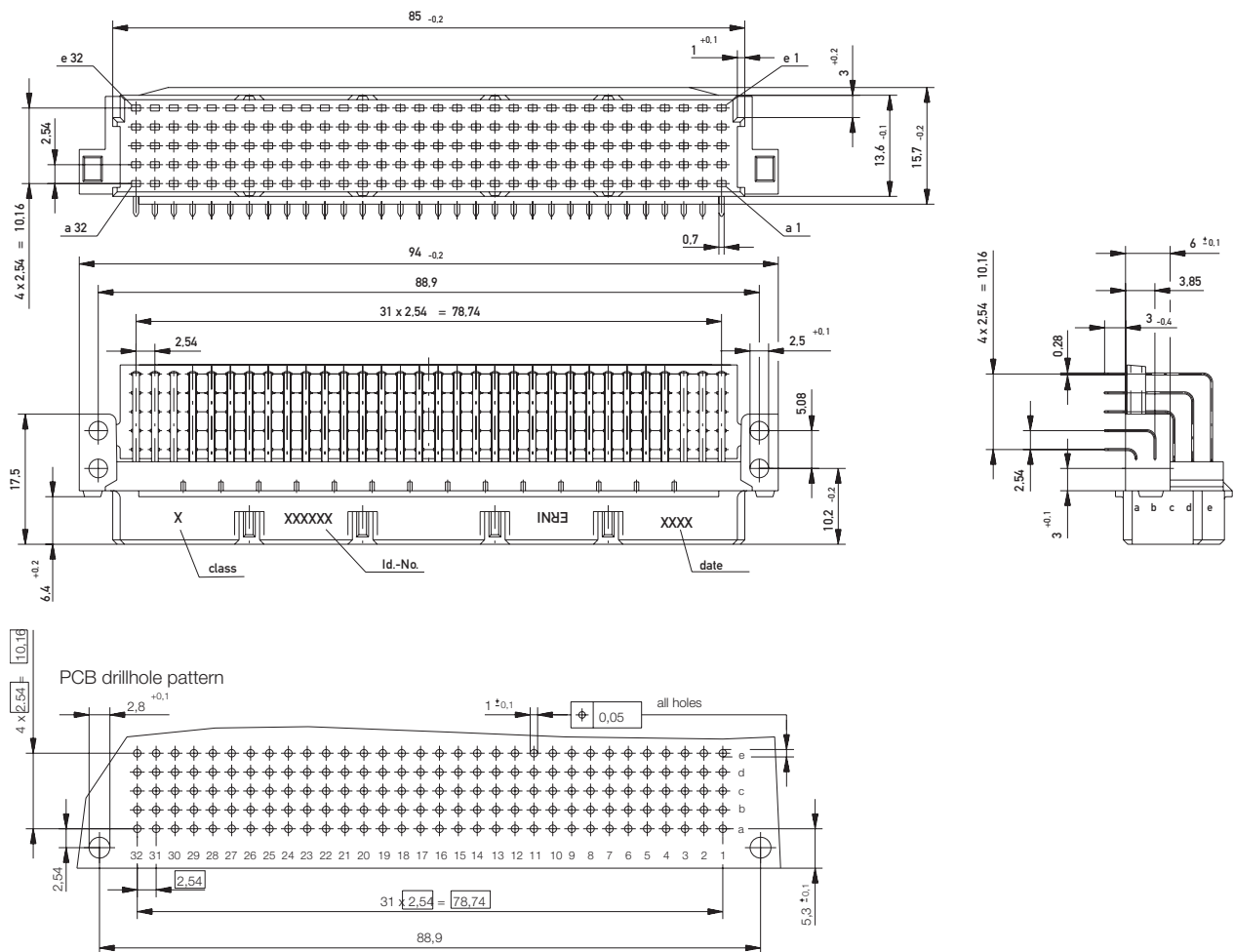

DIN 41612 / IEC 60603-2 Connectors

Type TE Female

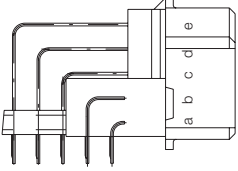
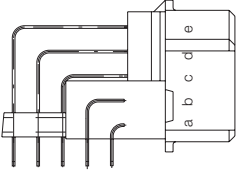
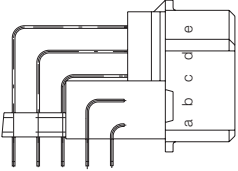

Ordering Information

No. of Pins	Termination	Term. Length	Pin Dimensions	Class	Pressfit Zone	Part Number
 160	Pressfit	3 mm	0.28 x 0.7 mm	2	1 mm	013157
 160	Solder	3 mm	0.28 x 0.7 mm	1	–	013166
 160	Solder	3 mm	0.28 x 0.7 mm	2	–	013167

DIN 41612 / IEC 60603-2 Connectors

Eurocard Center Connector



These Eurocard Center connectors fit precisely between two connectors mounted on a standard double Eurocard. The connector mounting flanges are standardized so that the Eurocard Center Connectors can be combined with sizes B, C, D, E, E160, M and H11 male connectors and with the size Q and R inverted female connectors according to DIN 41612/IEC 60603-2.

Dimensional Drawing Male Solder

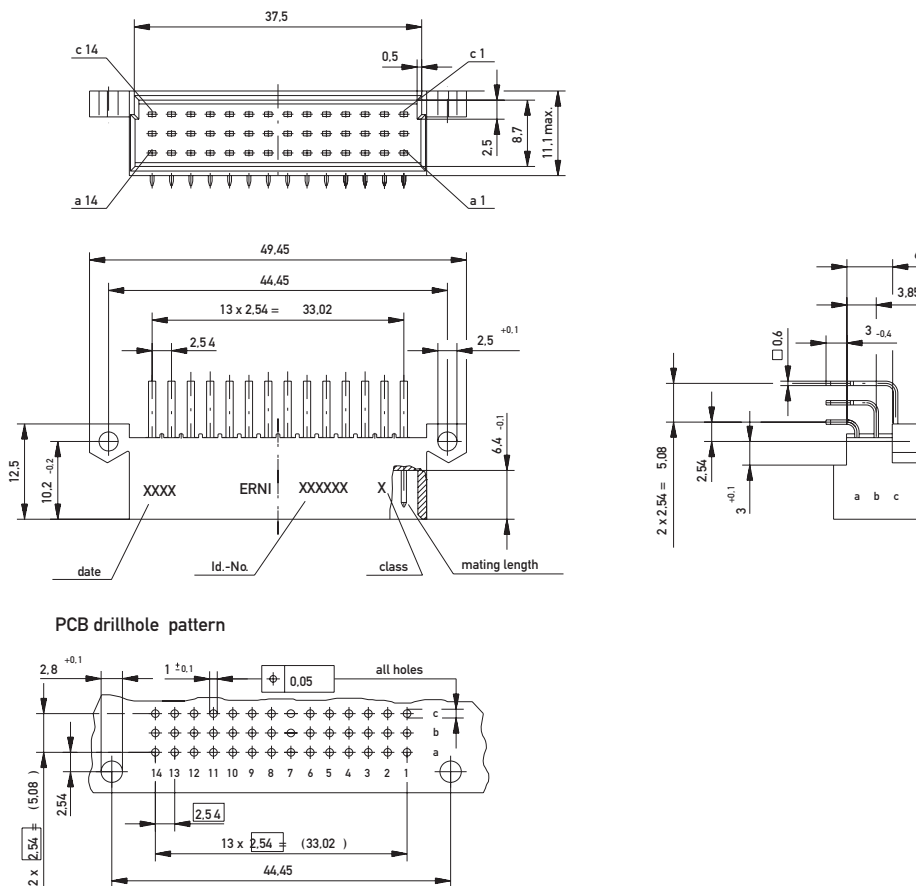



Dimensional Drawing Female Pressfit

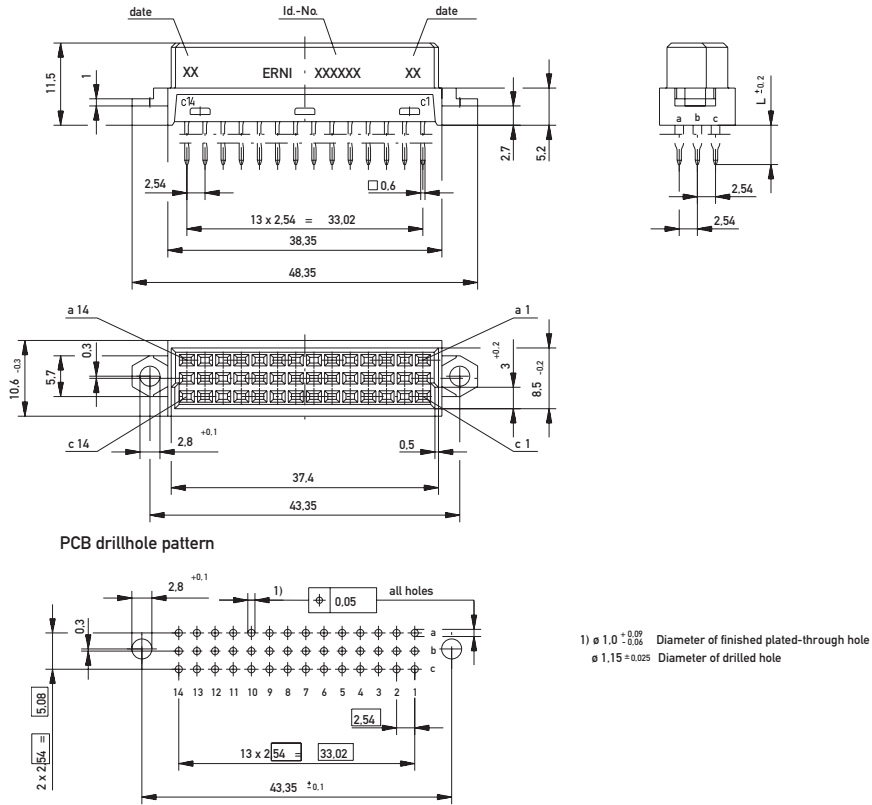

Dimensional Drawing Female Solder

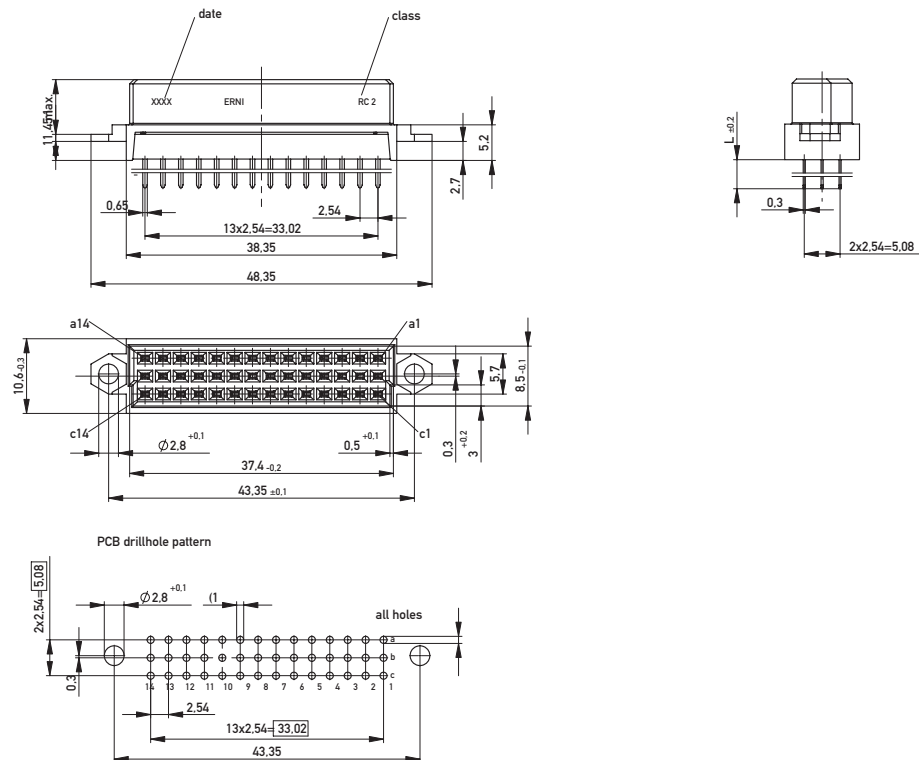

DIN 41612 / IEC 60603-2 Connectors

Eurocard Center Connector Male



Ordering Information

No. of Pins	Termination	Term. Length	Pin Dimensions	Class	Pressfit Zone	Part Number
42	Solder	3 mm	0.6 x 0.6 mm	1	–	433590
42	Solder	3 mm	0.6 x 0.6 mm	2	–	433591

Eurocard Center Connector Female

Ordering Information

No. of Pins	Termination	Term. Length	Pin Dimensions	Class	Pressfit Zone	Part Number
42	Pressfit	5.5 mm	0.6 x 0.6 mm	2	3 mm	004289
42	Solder	4 mm	0.6 x 0.6 mm	2		354972

DIN 41612 / IEC 60603-2 Connectors

Type D Male

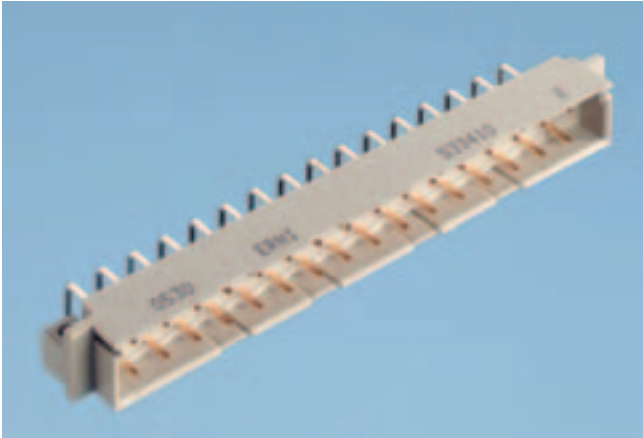

Dimensional Drawing Solder

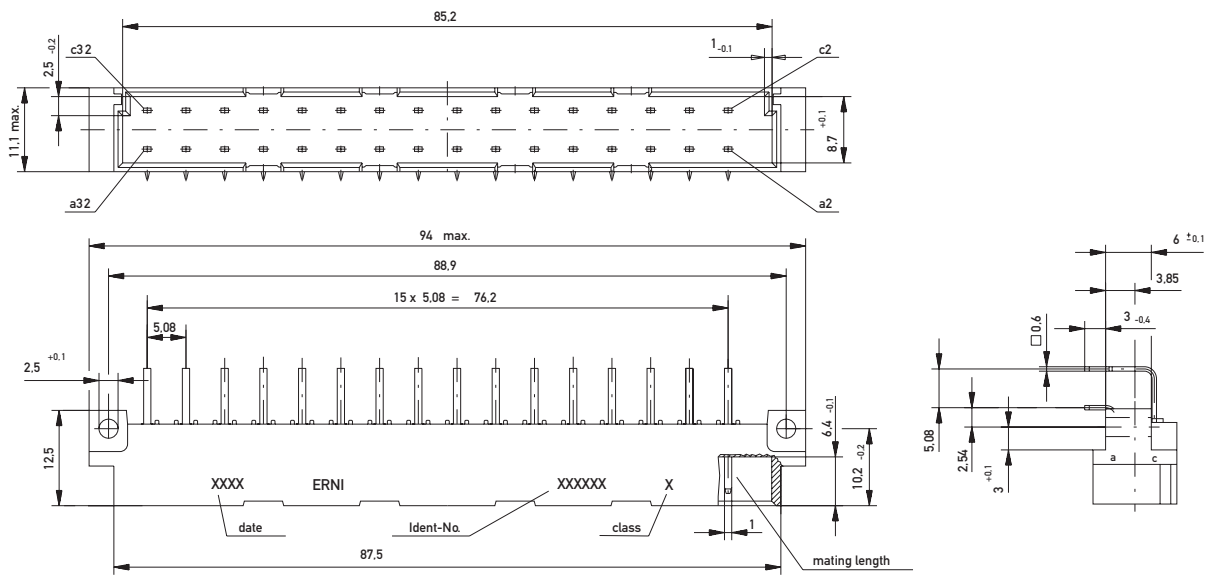

PCB drillhole pattern

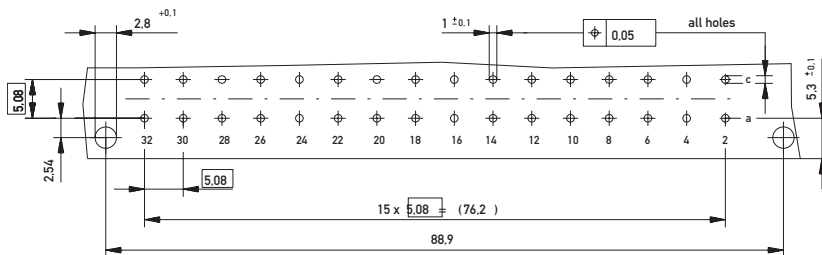

DIN 41612 / IEC 60603-2 Connectors

Type D Male



Dimensional Drawing Solder

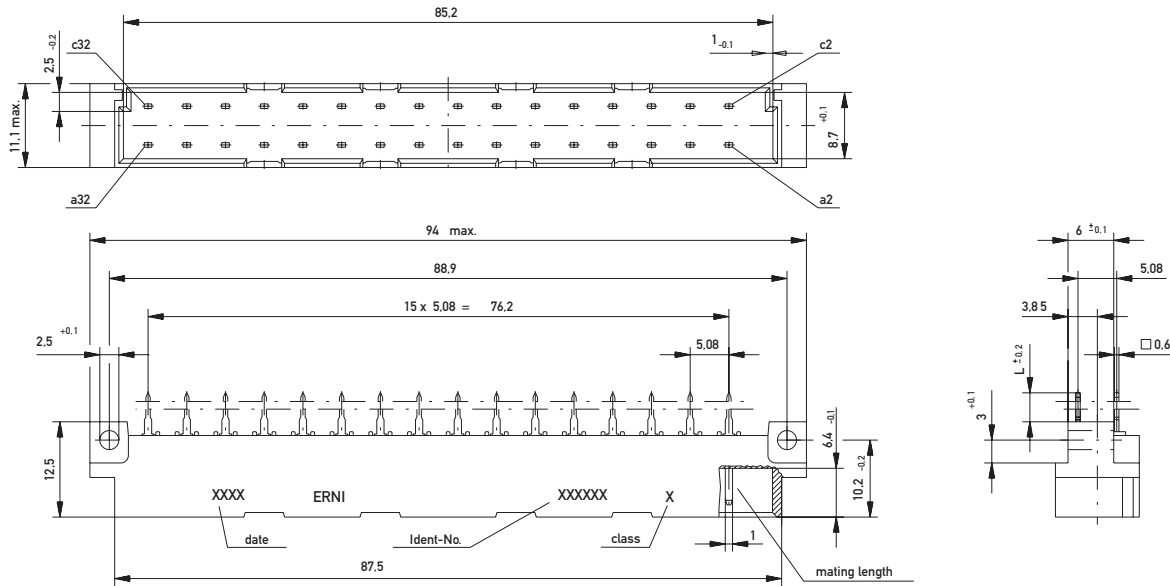

PCB drillhole pattern

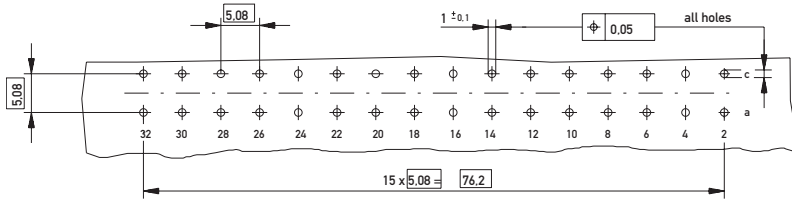

DIN 41612 / IEC 60603-2 Connectors

Type D Male

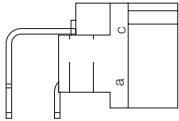
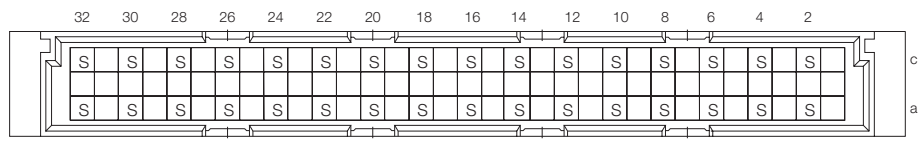
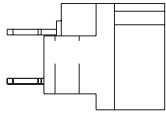
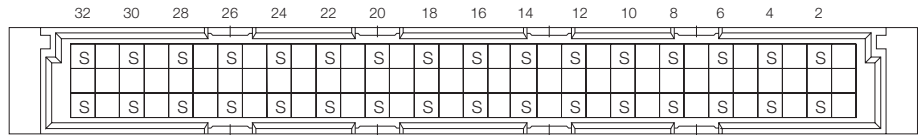

Ordering Information

No. of Pins	Termination	Term. Length	Pin Dimensions	Class	Pressfit Zone	Part Number
 	Solder	3 mm	0.6 x 0.6 mm	1	–	533210
 	Solder	3.8 mm	0.6 x 0.6 mm	2	–	594096

DIN 41612 / IEC 60603-2 Connectors

Type D Female



Dimensional Drawing Pressfit

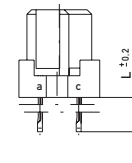
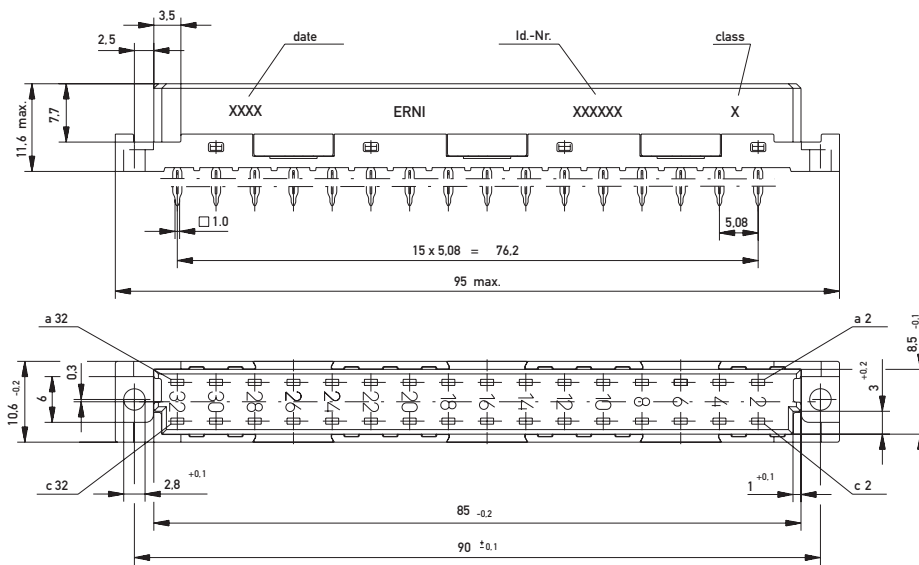

PCB drillhole pattern

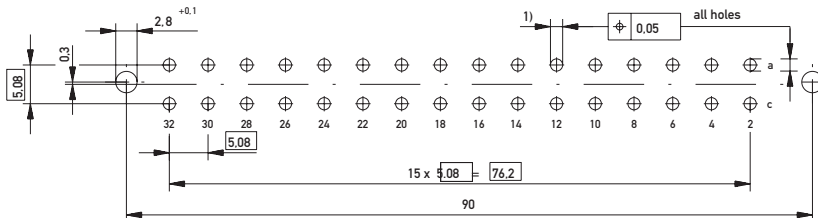

- 1) ϕ 1.6^{+0.09}/_{-0.06} Diameter of finished plated-through hole
- ϕ 1.75^{-0.03} Diameter of drilled hole see drawing 114407

DIN 41612 / IEC 60603-2 Connectors

Type D Female



Dimensional Drawing Solder

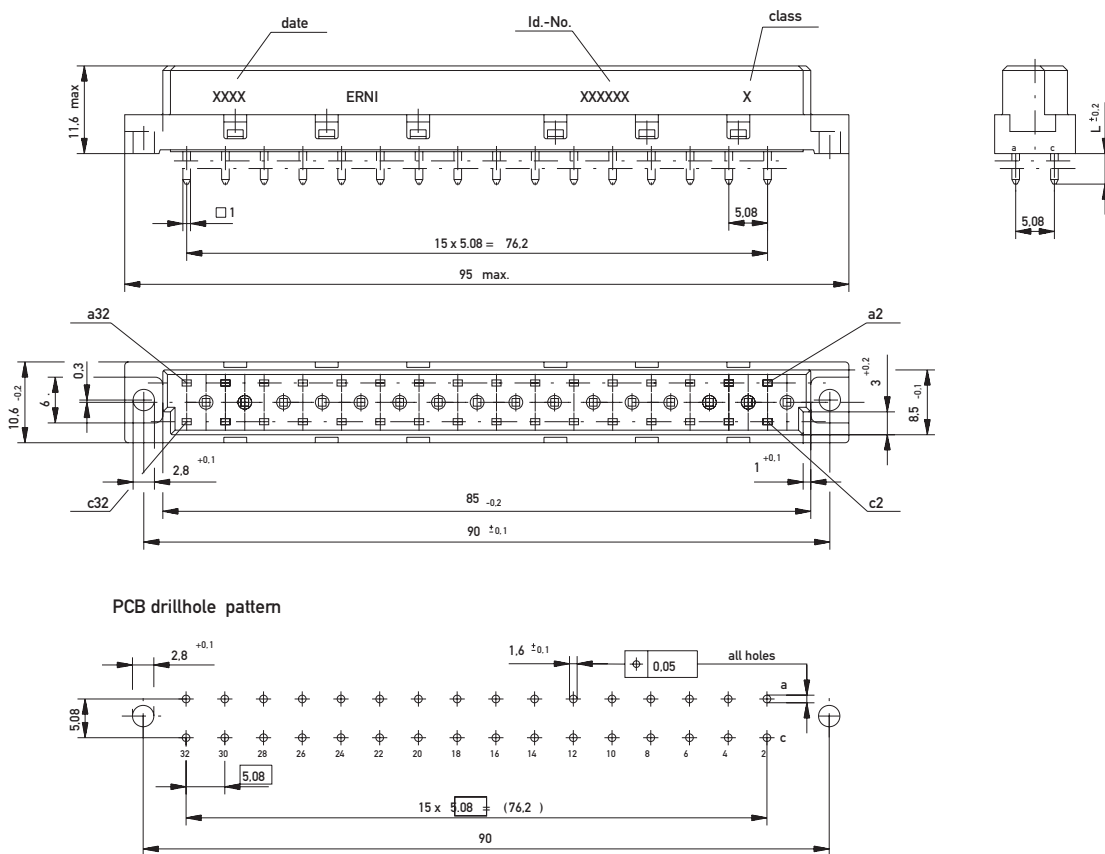

DIN 41612 / IEC 60603-2 Connectors

Type D Female



Ordering Information

No. of Pins	Termination	Term. Length	Pin Dimensions	Class	Pressfit Zone	Part Number
32	Pressfit	4.5 mm	0.6 x 0.6 mm	2	3 mm	033427
32	Pressfit*	6 mm	1 x 1 mm	1	2.5 mm	424803
32	Pressfit*	6 mm	1 x 1 mm	2	2.5 mm	424804
32	Pressfit* w/o Flange	6 mm	1 x 1 mm	1	2.5 mm	004427
32	Pressfit*	13 mm	1 x 1 mm	1	2.5 mm	013025
32	Pressfit*	26 mm	1 x 1 mm	1	2.5 mm	424797
32	Pressfit*	26 mm	1 x 1 mm	2	2.5 mm	424798
32	Pressfit* w. Transfer Zone	26 mm	1 x 1 mm	2	2.5 mm	424801

*For contact supporting press-in tool.

DIN 41612 / IEC 60603-2 Connectors

Type D Female

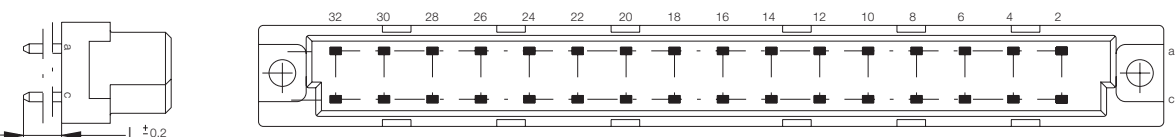

Ordering Information

No. of Pins	Termination	Term. Length	Pin Dimensions	Class	Pressfit Zone	Part Number
						
32	Solder	4 mm	1 x 1 mm	1	–	594569
32	Solder	4 mm	1 x 1 mm	2	–	594570
32	Solder	4.5 mm	0.6 x 0.6 mm	2	–	033428
32	Solder	4.5 mm	1.2 x 0.6 mm	2	–	033579
32	Solder	20 mm	1 x 1 mm	1	–	594566
32	Solder	20 mm	1 x 1 mm	2	–	594567

DIN 41612 / IEC 60603-2 Connectors

Type E Male

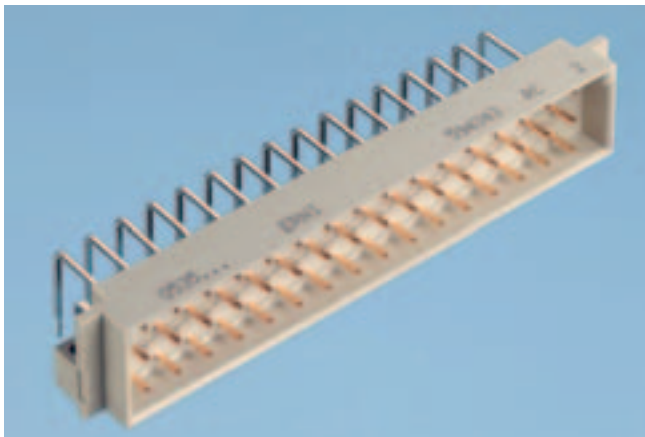

Dimensional Drawing Solder

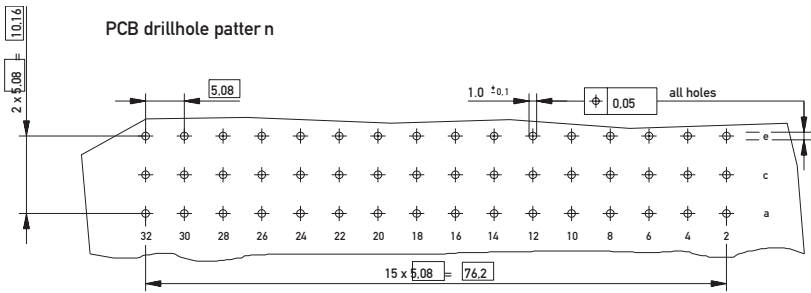
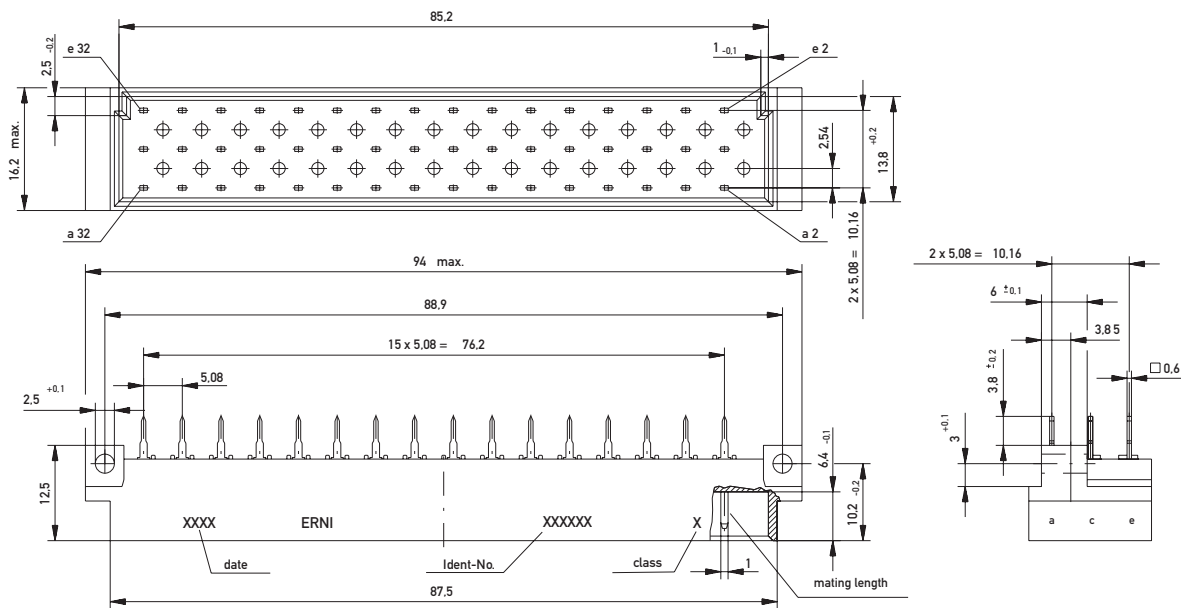

DIN 41612 / IEC 60603-2 Connectors

Type E Male

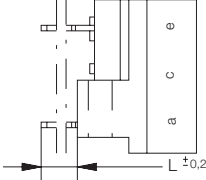
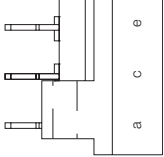
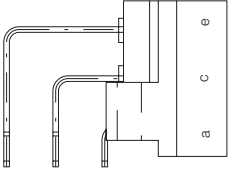

Ordering Information

No. of Pins	Termination	Term. Length	Pin Dimensions	Class	Pressfit Zone	Part Number
						
32	Solder	3 mm	1.0 x 0.6 mm	2	–	013414
						
48	Solder	3.8 mm	1.0 x 0.6 mm	2	–	063300
						
48	Solder	3 mm	1.0 x 0.6 mm	1	–	594802
48	Solder	3 mm	1.0 x 0.6 mm	2	–	594343

DIN 41612 / IEC 60603-2 Connectors

Type E Female



Dimensional Drawing Pressfit

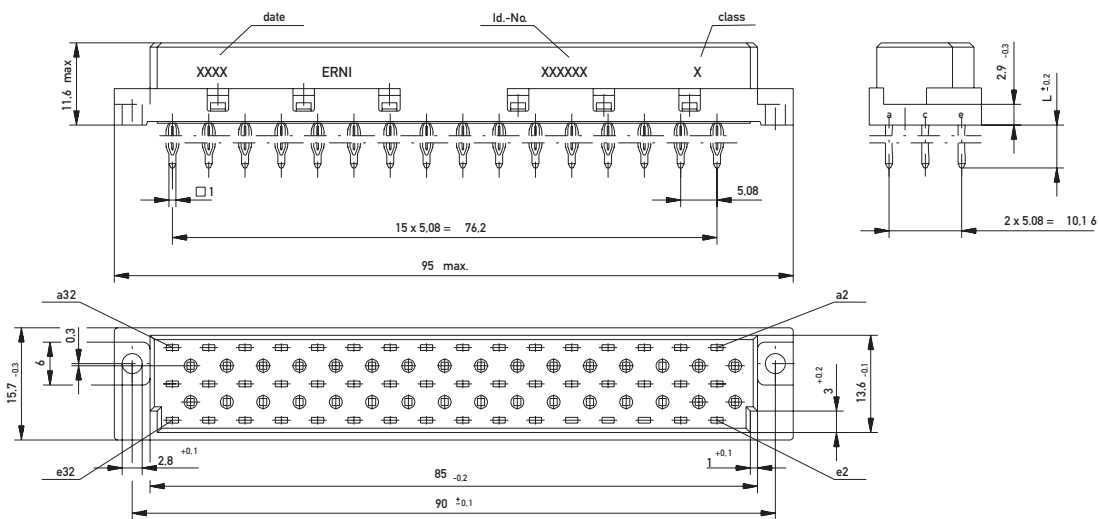

PCB drillhole pattern

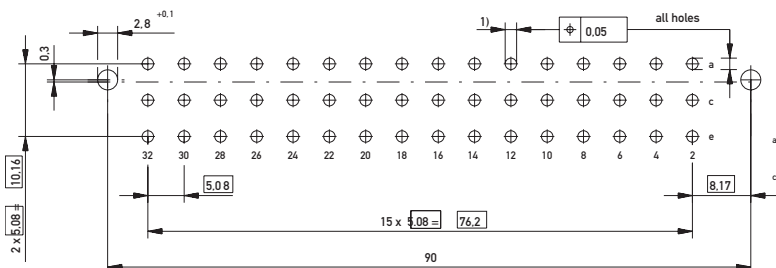

- 1) $\varnothing 1.6^{+0.09}_{-0.06}$ Diameter of finished plated-through hole
- $\varnothing 1.75^{-0.03}$ Diameter of drilled hole see drawing 114407



Dimensional Drawing Solder

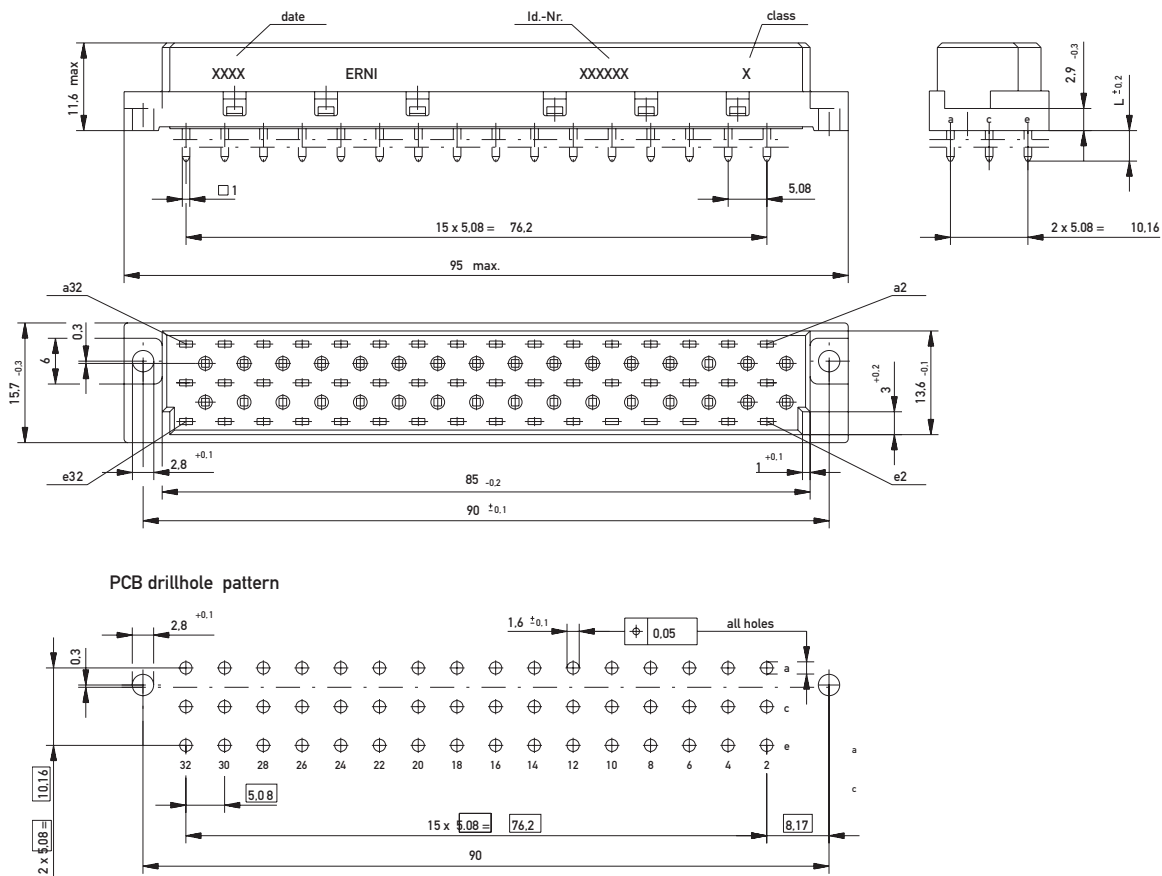

DIN 41612 / IEC 60603-2 Connectors

Type E Female

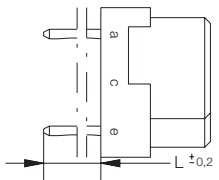
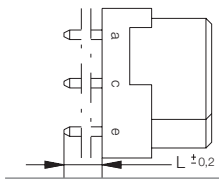

Ordering Information

No. of Pins	Termination	Term. Length	Pin Dimensions	Class	Pressfit Zone	Part Number
						
32	Pressfit*	6 mm	1 x 1 mm	2	2.5 mm	004177
						
48	Pressfit	4.5 mm	0.6 x 0.6 mm	2	3 mm	063465
48	Pressfit*	6 mm	1 x 1 mm	1	2.5 mm	424812
48	Pressfit*	6 mm	1 x 1 mm	2	2.5 mm	424813
48	Pressfit*	13 mm	1 x 1 mm	1	2.5 mm	013026
48	Pressfit w. Transfer Zone	13 mm	0.6 x 0.6 mm	2	2.5 mm	043064
48	Pressfit*	26 mm	1 x 1 mm	1	2.5 mm	424806
48	Pressfit*	26 mm	1 x 1 mm	2	2.5 mm	424807
48	Pressfit* w. Transfer Zone	26 mm	1 x 1 mm	2	2.5 mm	424810

* For contact supporting press-in tool.

DIN 41612 / IEC 60603-2 Connectors

Type E Female

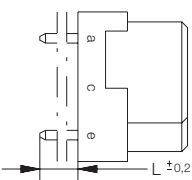
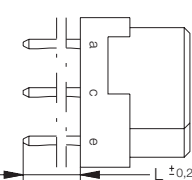

Ordering Information

No. of Pins	Termination	Term. Length	Pin Dimensions	Class	Pressfit Zone	Part Number
						
32	Solder	4 mm	1 x 1 mm	2	–	013653
						
48	Solder	4 mm	1 x 1 mm	1	–	594578
48	Solder	4 mm	1 x 1 mm	2	–	594579
48	Solder	4.5 mm	0.6 x 0.6 mm	2	–	063048
48	Solder	4.5 mm	1.2 x 0.6 mm	2	–	063046
48	Solder	20 mm	1 x 1 mm	1	–	594575
48	Solder	20 mm	1 x 1 mm	2	–	594576
48	Solder w. Transfer Zone	26 mm	1 x 1 mm	2	–	003382
48	Solder	8 mm	0.6 x 2.0 mm	2	–	063049

DIN 41612 / IEC 60603-2 Connectors

Type F Male



Ordering Information

No. of Pins	Termination	Term. Length	Pin Dimensions	Class	Pressfit Zone	Part Number
32	Solder	3 mm	0.6 x 0.6 mm	1	–	303284
32	Solder	3 mm	0.6 x 0.6 mm	2	–	303484
48	Solder	3 mm	0.6 x 0.6 mm	1	–	334203
48	Solder	3 mm	0.6 x 0.6 mm	2	–	334403



Dimensional Drawing Solder Type F flat

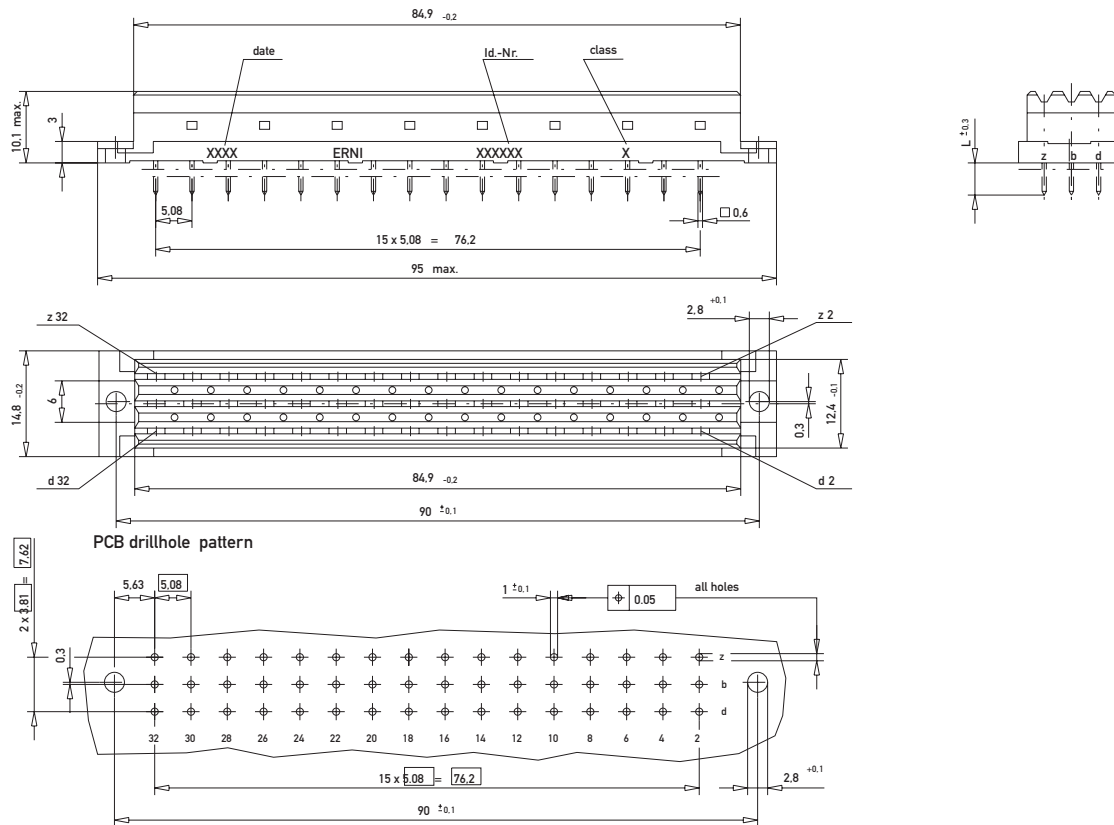

DIN 41612 / IEC 60603-2 Connectors

Type F Female

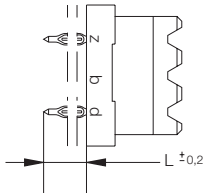
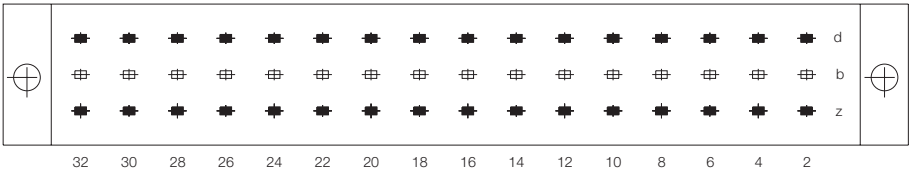
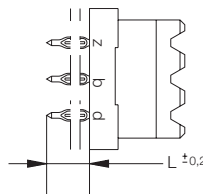
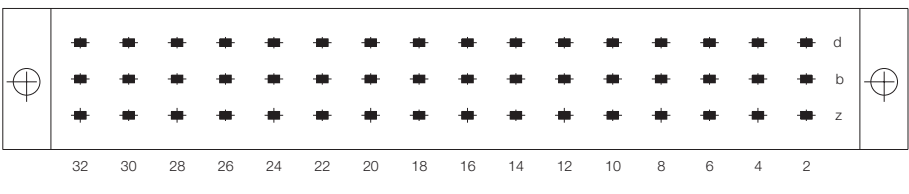
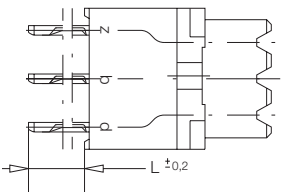
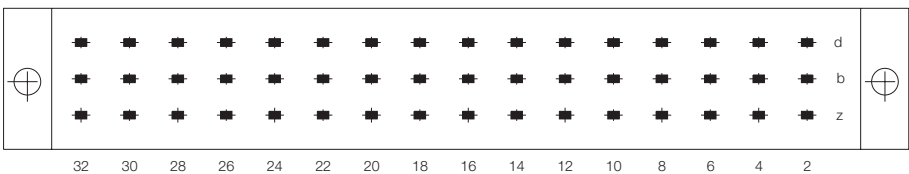

Ordering Information

No. of Pins	Termination	Term. Length	Pin Dimensions	Class	Pressfit Zone	Part Number
						
32	Pressfit	4.5 mm	0.6 x 0.6 mm	2	2 mm	063358
						
48	Pressfit	4.5 mm	0.6 x 0.6 mm	2	2 mm	054756
						
48	Pressfit	6 mm	1 x 1 mm	1	2.5 mm	013970
48	Pressfit	6 mm	1 x 1 mm	2	2.5 mm	594491
48	Pressfit	22 mm	1 x 1 mm	1	2.5 mm	593990
48	Pressfit	22 mm	1 x 1 mm	2	2.5 mm	593991

DIN 41612 / IEC 60603-2 Connectors

Type F Female



Ordering Information

No. of Pins	Termination	Term. Length	Pin Dimensions	Class	Pressfit Zone	Part Number
32	Solder	4.5 mm	0.6 x 0.6 mm	2	–	063357
32	Solder	4.5 mm	1 x 1 mm	2	–	314425
32	Solder	22 mm	1 x 1 mm	2	–	314404
32	Solder	10 mm	0.8 x 2.4 mm	1	–	314447
48	Solder	4.5 mm	0.6 x 0.6 mm	2	–	054755

DIN 41612 / IEC 60603-2 Connectors

Type F Female



Ordering Information

No. of Pins	Termination	Term. Length	Pin Dimensions	Class	Pressfit Zone	Part Number
48	Solder	4.5 mm	1 x 1 mm	1	–	344265
48	Solder	4.5 mm	1 x 1 mm	2	–	344465
48	Solder	22 mm	1 x 1 mm	1	–	344234
48	Solder	22 mm	1 x 1 mm	2	–	344434
48	Solder	z, d = 10.0 mm b = 17 mm	0.8 x 2.4 mm	1	–	344451

DIN 41612 / IEC 60603-2 Connectors

Type M Male



The Type M mixed connector series based on a 100" (2.54mm) pitch in accordance with the DIN41612/IEC 60603-2 specification. This series of connectors is designed to accommodate a variety of coaxial and high current contacts which are also used in other popular connector systems such as the 2mm Hard Metric Type M connectors.

The male and female connectors have 2, 4, 6, 8 or 10 empty "cavities" to accommodate the special contacts.

The versatility of mixing both signal and either high current or coax contacts increases the usage of this connector in telecommunication and data processing applications.

Dimensional Drawing Solder

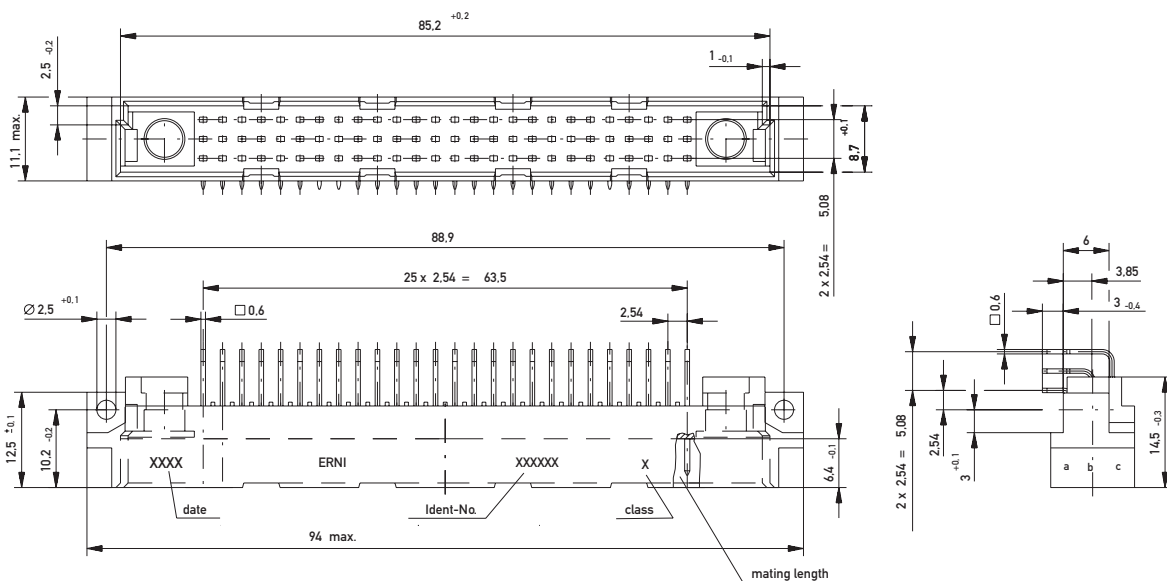

PCB drillhole pattern

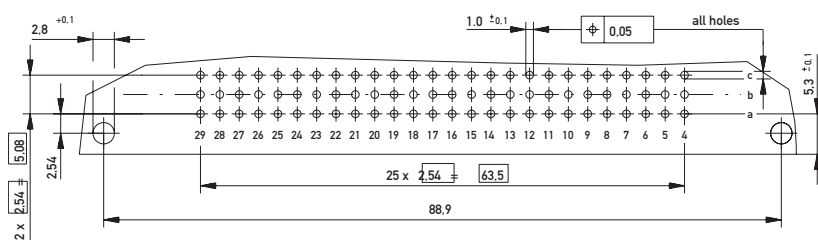

DIN 41612 / IEC 60603-2 Connectors

Type M Male

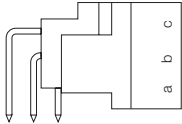
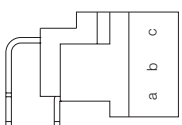
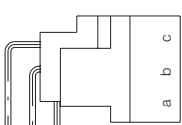
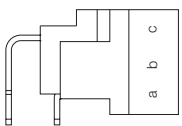
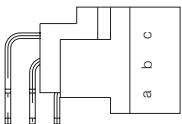

Ordering Information

No. of Pins	Termination	Term. Length	Pin Dimensions	Class	Pressfit Zone	Part Number
 6-10	Solder	3 mm	0.6 x 0.6 mm	1	–	024201
 16-8	Solder	3 mm	0.6 x 0.6 mm	1	–	594165
16-8	Solder	3 mm	0.6 x 0.6 mm	2	–	594166
 24-8	Solder	3 mm	0.6 x 0.6 mm	1	–	593817
24-8	Solder	3 mm	0.6 x 0.6 mm	2	–	593818
 28-6	Solder	3 mm	0.6 x 0.6 mm	1	–	594162
28-6	Solder	3 mm	0.6 x 0.6 mm	2	–	594163
 42-6	Solder	3 mm	0.6 x 0.6 mm	1	–	593814
42-6	Solder	3 mm	0.6 x 0.6 mm	2	–	593815

DIN 41612 / IEC 60603-2 Connectors

Type M Male



Ordering Information

No. of Pins	Termination	Term. Length	Pin Dimensions	Class	Pressfit Zone	Part Number
40-4	Solder	3 mm	0.6 x 0.6 mm	1	–	594159
40-4	Solder	3 mm	0.6 x 0.6 mm	2	–	594160
60-4	Solder	3 mm	0.6 x 0.6 mm	1	–	593811
60-4	Solder	3 mm	0.6 x 0.6 mm	2	–	593812
52-2	Solder	3 mm	0.6 x 0.6 mm	2	–	594157
78-2	Solder	3 mm	0.6 x 0.6 mm	1	–	593808
78-2	Solder	3 mm	0.6 x 0.6 mm	2	–	593809

DIN 41612 / IEC 60603-2 Connectors

Type M Female



Dimensional Drawing Pressfit

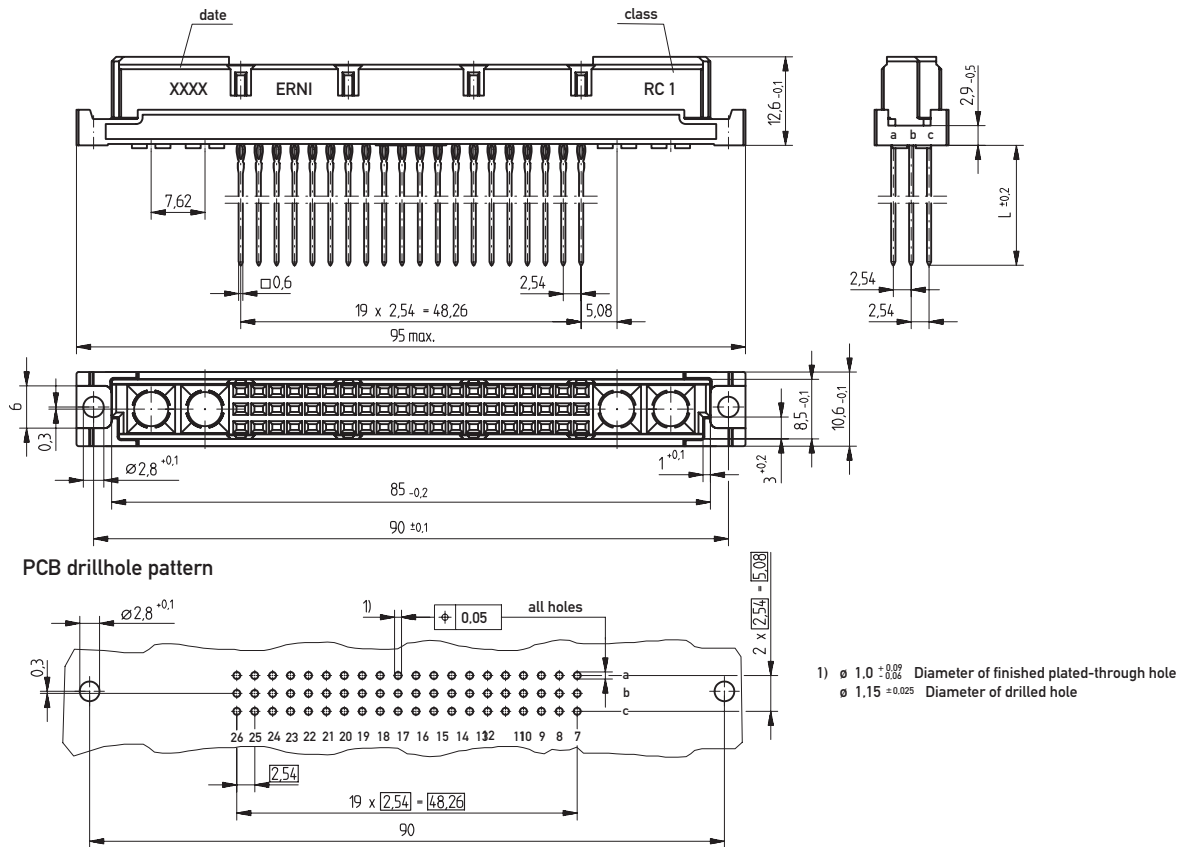

DIN 41612 / IEC 60603-2 Connectors

Type M Female



Dimensional Drawing Pressfit Modified

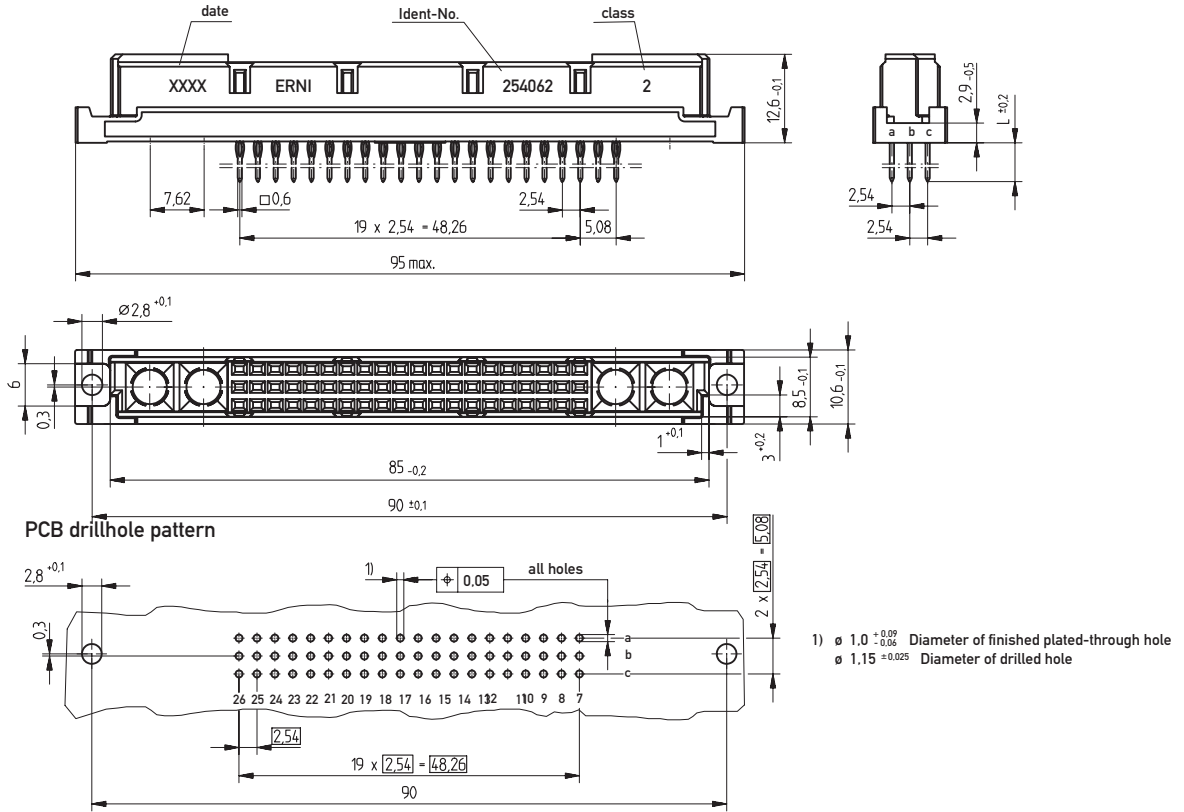

Dimensional Drawing Solder

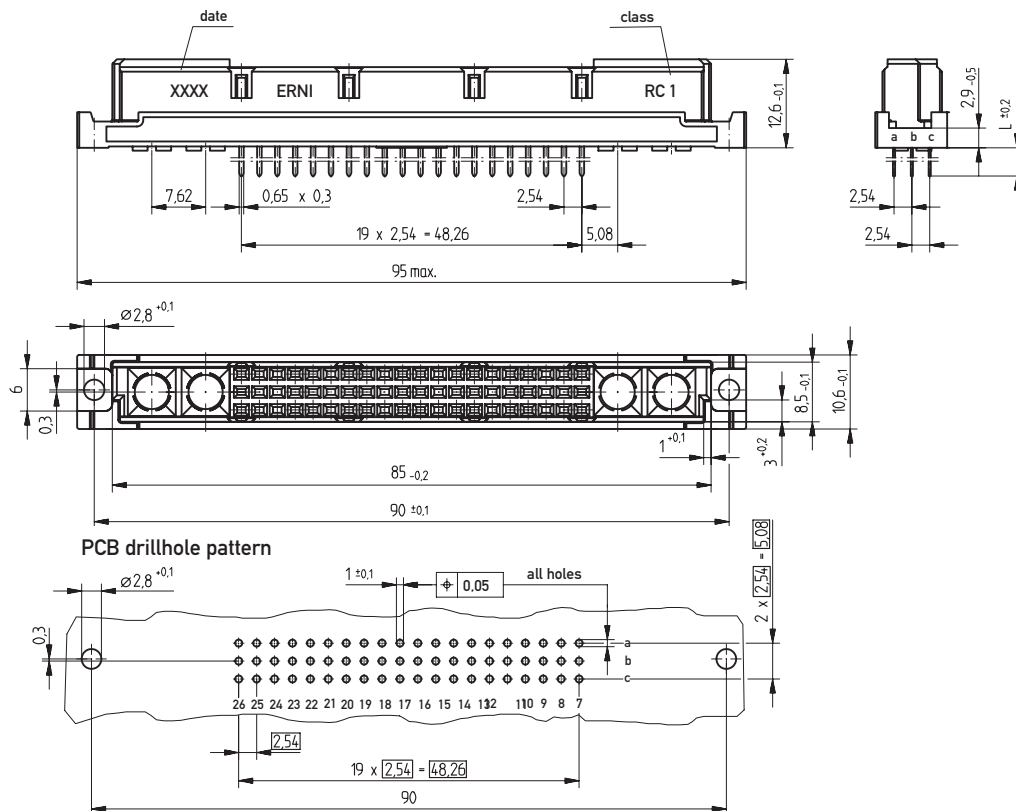

DIN 41612 / IEC 60603-2 Connectors

Type M Female

Ordering Information

No. of Pins	Termination	Term. Length	Pin Dimensions	Class	Pressfit Zone	Part Number
6-10	Pressfit	5.5 mm	0.6 x 0.6 mm	2	3 mm	354252
6-10	Pressfit	17 mm	0.6 x 0.6 mm	2	3 mm	364366
6-10	Pressfit Modified	5.5 mm	0.6 x 0.6 mm	2	3 mm	354197
24-8	Pressfit	5.5 mm	0.6 x 0.6 mm	1	3 mm	354246
24-8	Pressfit	5.5 mm	0.6 x 0.6 mm	2	3 mm	354116
24-8	Pressfit	17 mm	0.6 x 0.6 mm	2	3 mm	354247
24-8	Pressfit Modified	5.5 mm	0.6 x 0.6 mm	2	3 mm	294743
28-6	Pressfit	5.5 mm	0.6 x 0.6 mm	2	3 mm	374849
42-6	Pressfit	5.5 mm	0.6 x 0.6 mm	2	3 mm	294740
42-6	Pressfit	17 mm	0.6 x 0.6 mm	2	3 mm	294732
42-6	Pressfit Modified	5.5 mm	0.6 x 0.6 mm	2	–	294736

DIN 41612 / IEC 60603-2 Connectors

Type M Female



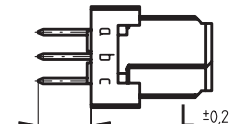
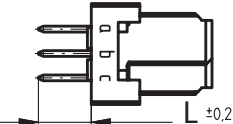

Ordering Information

No. of Pins	Termination	Term. Length	Pin Dimensions	Class	Pressfit Zone	Part Number
 40-4	Pressfit	5.5 mm	0.6 x 0.6 mm	2	3 mm	294737
 60-4	Pressfit	5.5 mm	0.6 x 0.6 mm	1	3 mm	354139
60-4	Pressfit	5.5 mm	0.6 x 0.6 mm	2	3 mm	294728
60-4	Pressfit	17 mm	0.6 x 0.6 mm	1	3 mm	294710
60-4	Pressfit Modified	5.5 mm	0.6 x 0.6 mm	2	–	254062
60-4	Pressfit	17 mm	0.6 x 0.6 mm	2	3 mm	354140
 78-2	Pressfit	5.5 mm	0.6 x 0.6 mm	2	3 mm	294733

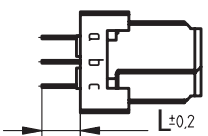
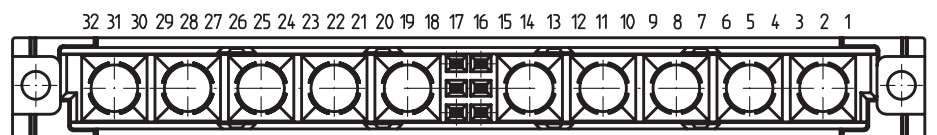
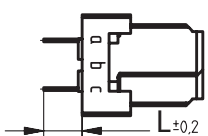
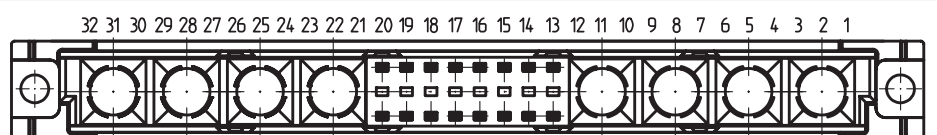

Ordering Information

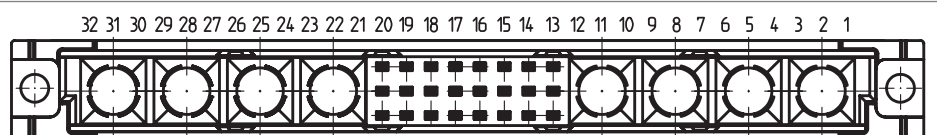
No. of Pins	Termination	Term. Length	Pin Dimensions	Class	Pressfit Zone	Part Number	
							
	6-10	Solder	4 mm	0.65 x 0.3 mm	1	–	294712
	6-10	Solder	13 mm	0.6 x 0.6 mm	1	–	354152
6-10	Solder	13 mm	0.6 x 0.6 mm	2	–	354223	
							
	16-8	Solder	4 mm	0.65 x 0.3 mm	1	–	354239
	16-8	Solder	4 mm	0.65 x 0.3 mm	2	–	354162
16-8	Solder	13 mm	0.6 x 0.6 mm	2	–	354166	
							
	24-8	Solder	4 mm	0.65 x 0.3 mm	1	–	354163
	24-8	Solder	4 mm	0.65 x 0.3 mm	2	–	294711
	24-8	Solder	13 mm	0.6 x 0.6 mm	1	–	354157
24-8	Solder	13 mm	0.6 x 0.6 mm	2	–	354219	

DIN 41612 / IEC 60603-2 Connectors

Type M Female



Ordering Information

No. of Pins	Termination	Term. Length	Pin Dimensions	Class	Pressfit Zone	Part Number
28-6	Solder	4 mm	0.65 x 0.3 mm	2	–	354226
28-6	Solder	4 mm	0.6 x 0.6 mm	1	–	354229
28-6	Solder	13 mm	0.6 x 0.6 mm	2	–	354164
42-6	Solder	4 mm	0.65 x 0.3 mm	1	–	354112
42-6	Solder	4 mm	0.65 x 0.3 mm	2	–	354108
42-6	Solder	13 mm	0.6 x 0.6 mm	1	–	354215
42-6	Solder	13 mm	0.6 x 0.6 mm	2	–	354173
40-4	Solder	4 mm	0.65 x 0.3 mm	1	–	354240
40-4	Solder	4 mm	0.65 x 0.3 mm	2	–	354161
40-4	Solder	13 mm	0.6 x 0.6 mm	2	–	354160



Ordering Information

No. of Pins	Termination	Term. Length	Pin Dimensions	Class	Pressfit Zone	Part Number
60-4	Solder	4 mm	0.65 x 0.3 mm	1	–	354133
60-4	Solder	4 mm	0.65 x 0.3 mm	2	–	354111
60-4	Solder	13 mm	0.6 x 0.6 mm	1	–	354156
60-4	Solder	13 mm	0.6 x 0.6 mm	2	–	354165
52-2	Solder	4 mm	0.65 x 0.3 mm	2	–	354110
52-2	Solder	13 mm	0.6 x 0.6 mm	2	–	354109
78-2	Solder	4 mm	0.65 x 0.3 mm	1	–	354158
78-2	Solder	4 mm	0.65 x 0.3 mm	2	–	354117
78-2	Solder	13 mm	0.6 x 0.6 mm	1	–	354155
78-2	Solder	13 mm	0.6 x 0.6 mm	2	–	294730

Special Contacts, Electrical and Mechanical Specifications

Coaxial Contacts	Standard	
Technical Specifications		
Temperature Range	DIN EN 60068-1	-55/125 °C
Wave impedance		50 Ω and 75 Ω
Dielectric withstanding voltage 50 Hz	IEC 60512-2 Test 4a	750 V
Insulation resistance	IEC 60512-2 Test 3a	≥ 10 ¹⁰ Ω
Volume resistance		
Inner conductor	DIN 41640-5 Test 2b	≤ 6 mΩ
Outer conductor		≤ 3 mΩ
Frequency range		max. 3 GHz
Reflection factor	DIN 47275-3	max. 0.05 to 1 GHz max. 0.07 to 4 GHz max. 0.10 to 10 GHz

Materials

Outer Conductor	Cu Alloy
Female contact	Cu Be hardened
Insulation part	PTFE
Crimp Sleeve	Cu

PERFORMANCE CLASSES

Class 1 Meets the requirements of DIN 41626. Internal conductor and external conductor gold-plated. Performance class 1 ≥ 500 mating cycles. Class 2 As per performance class 1 but performance class 2 ≥ 400 mating cycles.

High Current Contacts

High Current Contacts	Standard	
Technical Specifications		
Temperature Range	DIN EN 60068-1	-55/125 °C
Current-Carrying Capacity	DIN 41640-3 Test 5b	30 A at 70° C
Dielectric withstanding voltage 50 Hz	IEC 60512-2 Test 4a	2500 V
Volume resistance	DIN 41640-5 Test 2b	≤ 1 mΩ
Materials		
Male Contact	Cu Alloy	
Female Contact	Cu Be hardened	

PERFORMANCE CLASSES

Class 1 Meets the requirements of DIN 41626. Contacts are gold-plated. Performance class 1 ≥ 500 mating cycles. Class 2 As per performance class 1 but performance class 2 ≥ 400 mating cycles.

DIN 41612 / IEC 60603-2 Connectors

Special Contacts for Type M Male and Female



These special contacts, available in both Coax and High Current are inserted into the empty cavities provided in the Type M connector. The special contacts must be ordered separately as they are typically crimped or soldered onto the cable before insertion into the connector housing.

The coax contacts are available in 50 and 75 Ω in both right angle and straight configurations. ERNI offers contacts that can be crimped or soldered to cable or even soldered directly onto the PC board.

The high current contacts are available for 10, 20 and 40 amps. They can be soldered directly to the board or soldered or crimped to cable. Again, they are offered in both right angle or straight. Special high current versions are also available to assemble into the board. The pressfit contacts are designed to be used with the modified female connectors and to sit flush on the board.

Both the coax and high current contacts are simply snapped into the housing. No special tooling is required for insertion with the exception of the pressfit high current contact. A pressfit tool is required to press the entire assembly with the power contact into the board. An extraction tool is available if it would become necessary to remove any one of the special contacts.

Coaxial Male Contacts For DIN Backplane Connectors

Part-No.	RATING	CLASS	DESCRIPTION	CABLE	
053400	50 ohm	1	Straight, double braided	RG316 DB	
594213	50 ohm	1	Straight	RG174/U, RG188A/U, RG316/U	
053408	75 ohm	1	Straight	RG179B/U, RG187A/U	
594215	50 ohm	1	Right Angle	RG174/U, RG188A/U, RG316/U	
064755	50 ohm	2	Right Angle for .125" panel	RG174/U, RG188A/U, RG316/U	
064757	50 ohm	1	Right Angle, thick back-plane, double braided	RG316 DB	
064312*	50 ohm	1	Straight, 3 leg (sits flush on PCB)	PCB	

* To be used with Modified Female Connector Housings Type M.

Coaxial Female Contacts For DIN Daughter Card Connectors

Part-No.	RATING	CLASS	DESCRIPTION	CABLE	
053395	50 ohm	1	Straight, double braided	RG316 DB	
594207	50 ohm	1	Straight	RG174/U, RG188A/U, RG316/U	
053410	75 ohm	1	Straight	RG179B/U, RG187A/U	
594209	50 ohm	1	Right Angle	RG174/U, RG188A/U, RG316/U	
053412	70 ohm	1	Right Angle	RG179B/U, RG 187A/U	
594211	50 ohm	1	Right Angle, 5 leg	PCB	
123211	75 ohm	1	Right Angle, 5 leg	PCB	

DIN 41612 / IEC 60603-2 Connectors

Special Contacts for Type M Male and Female



High Current Female Contacts For DIN Backplane Connectors

Part-No.	RATING	CLASS	DESCRIPTION	CABLE
594172	10 amp	1	Solder	Awg 16-20
594174	20 amp	1	Solder	Awg 12-16
594176	40 amp	1	Solder	Awg 8-12
594178	10 amp	1	Crimp	Awg 16-20
594180	20 amp	1	Crimp	Awg 12-16
594182	40 amp	1	Crimp	Awg 8-12
913637	40 amp	2	Straight, 1 leg, 5.5 mm diameter	PCB



Pressfit High Current Contacts For DIN Backplane Connectors

Part-No.	RATING	CLASS	Description	Plated PCB Hole Diameter	Drilled PCB Hole Diameter
034190	20 amp	2	Straight, FD	3.0 +.04 / - .06	3.1 + 0 / - .03
044639*	40 amp	2	Straight, Pressfit	3.5 +.04 / - .06	3.6 + 0 / - .03

* To be used with Modified Female Connector Housings Type M.

High Current Male Contacts For DIN Daughter Card Connectors

Part-No.	RATING	CLASS	DESCRIPTION	CABLE
594221	10 amp	1	Solder	Awg 16-20
594223	20 amp	1	Solder	Awg 12-16
594225	40 amp	1	Solder	Awg 8-12
594227	10 amp	1	Crimp	Awg 16-20
594229	20 amp	1	Crimp	Awg 12-16
594231	40 amp	1	Crimp	Awg 8-12
594170	10 amp	1	Right Angle, 1 leg	PCB
594168	40 amp	1	Right Angle, 4 leg, .200" sq. FTPT	PCB
913716	40 amp	2	Right Angle, 4 leg, EMLB	PCB



Additional High Current contacts in Performance Class 2 on request

DIN 41612 / IEC 60603-2 Connectors

Special Contacts for Type M Male and Female



Tooling

High Current Contacts

Hand tool for crimp contacts Part-No. **594184**
 Contact Locator Part-No. **914004**



Coaxial Contacts

Hand tools for crimp contacts Part-No. **594219**
 Insert for crimping tools Part-No. **594220**



Extraction Tool For Coaxial And High Current Contacts

For replacing special contacts in male or female connectors Part-No. **594233**
 Replacement inserts for press-out tool Part-No. **433222**



Assembly Instructions For Cable Connections

For Angled Coaxial Contact Assembly

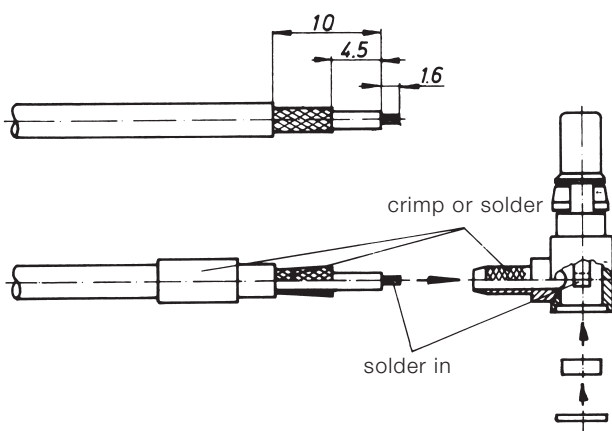

For Straight Coaxial Contact Assembly

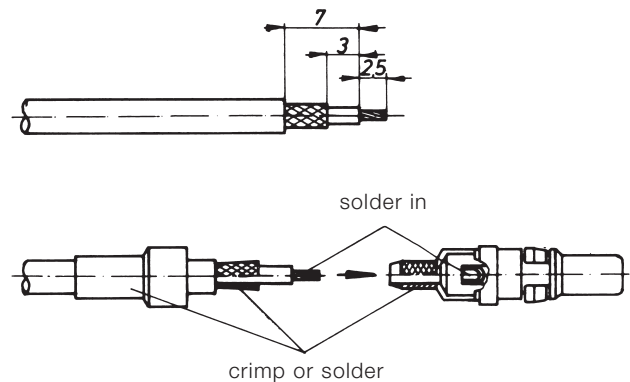

DIN 41612 / IEC 60603-2 Connectors

Type H11



Dimensional Drawing Solder Male

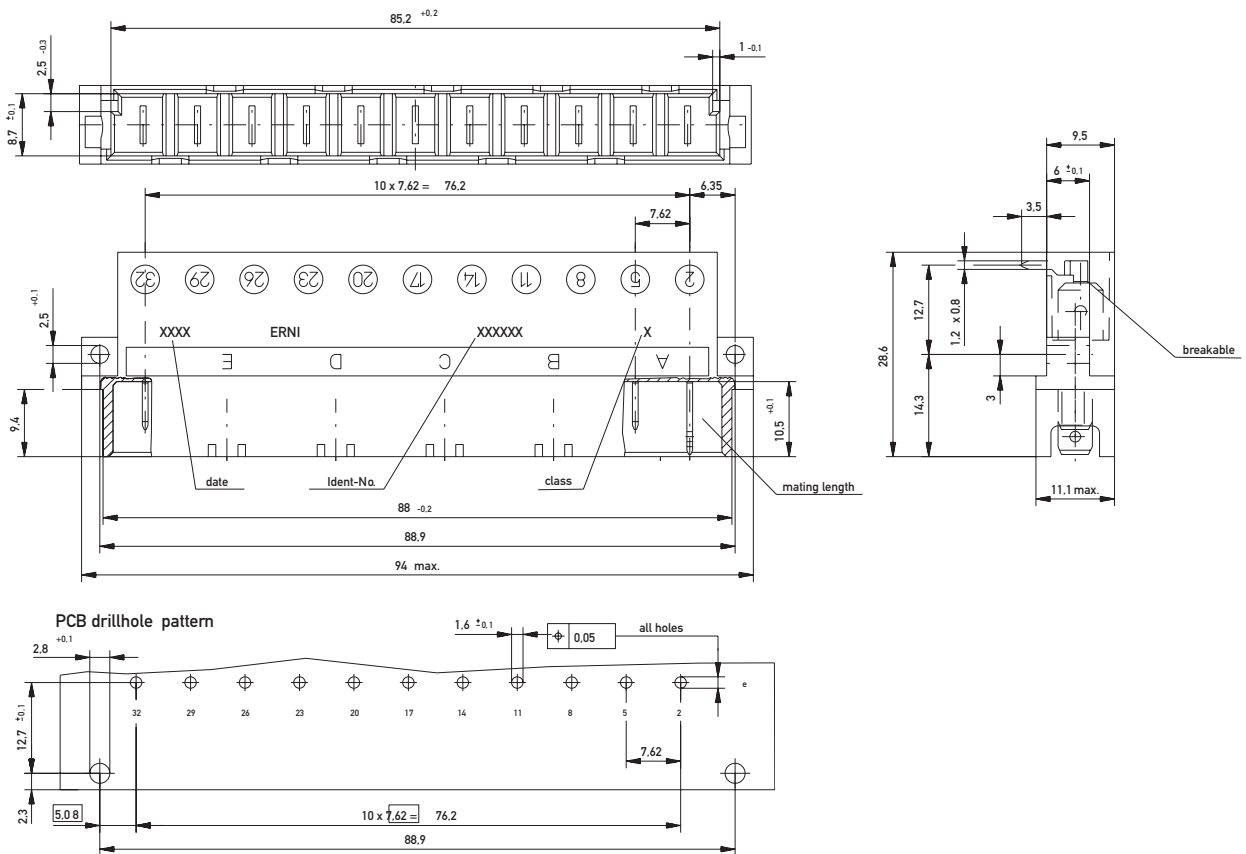



Dimensional Drawing Faston Male

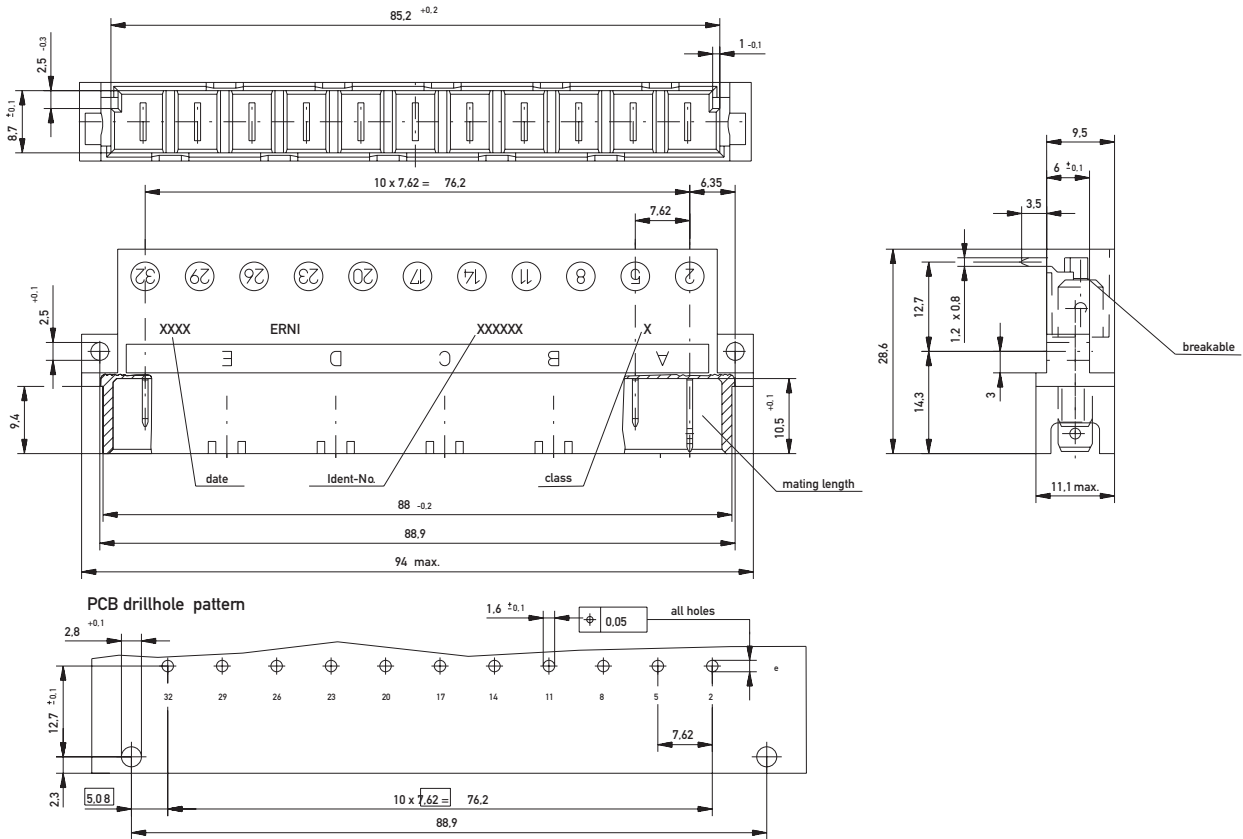

Dimensional Drawing Pressfit Female

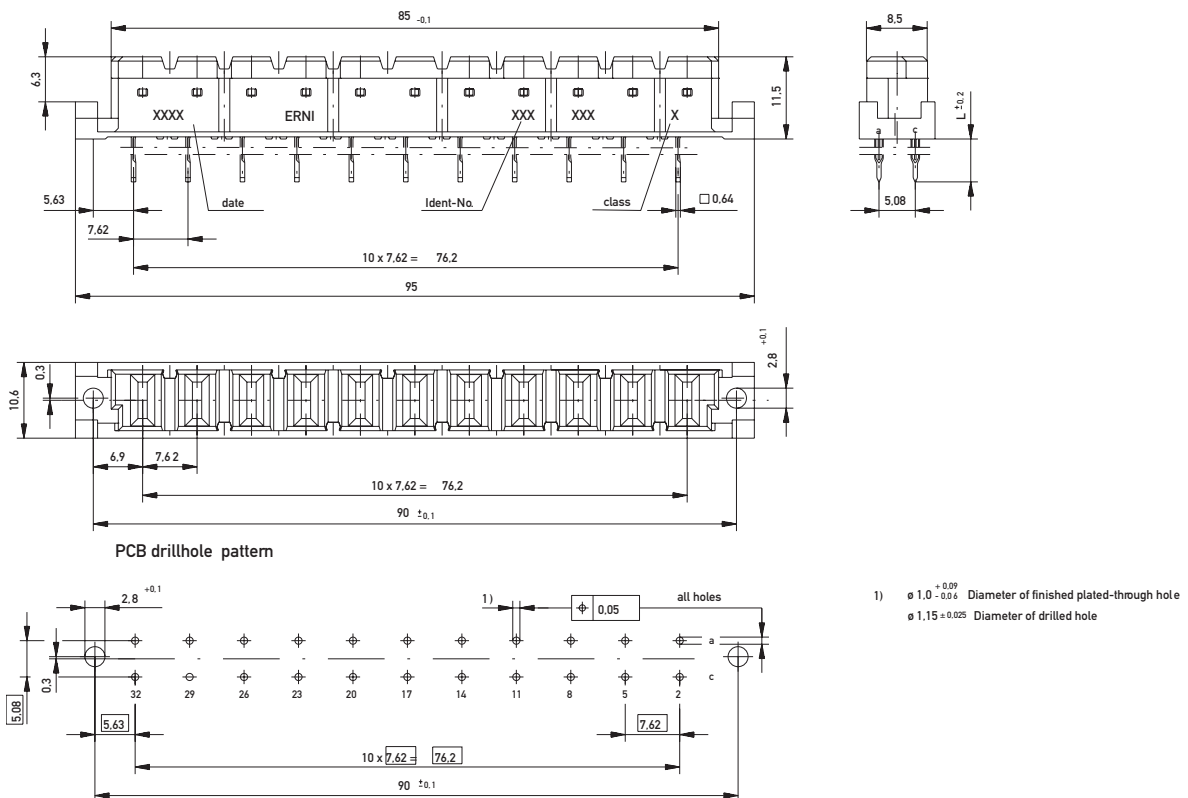

Ordering Information

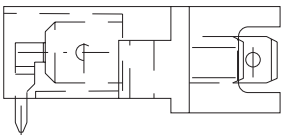
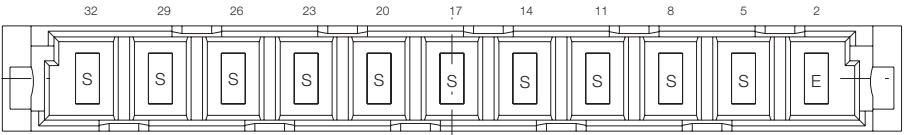
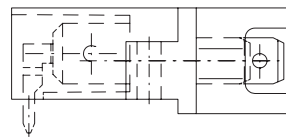
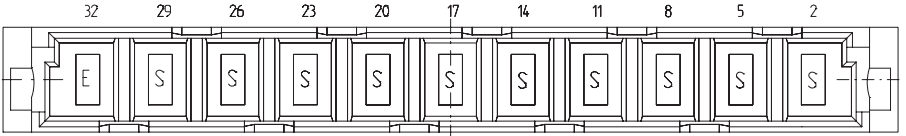
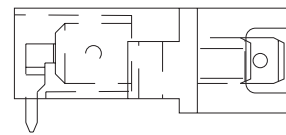
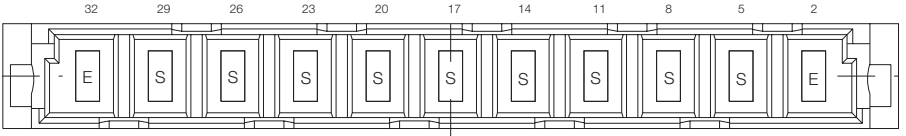
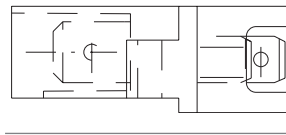
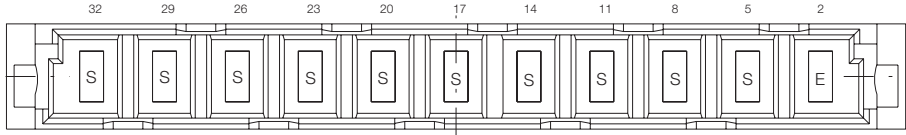
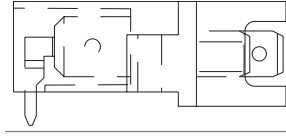
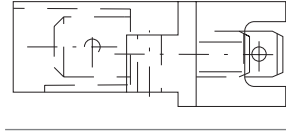
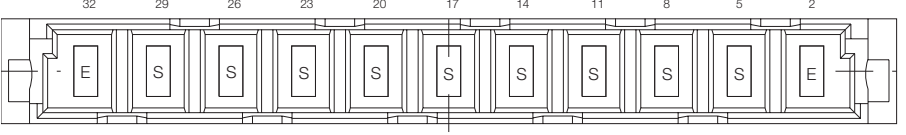

No. of Pins	Termination	Term. Length	Pin Dimensions	Class	Pressfit Zone	Part Number
						
11	Solder	3.5 mm	1.2 x 0.8 mm	1	–	233232
						
11	Solder	3.5 mm	1.2 x 0.8 mm	1	–	233230
						
11	Solder	3.5 mm	1.2 x 0.8 mm	1	–	233235
						
11	Faston	8 mm	6.3 x 0.8 mm	1	–	233233
						
11	Faston	8 mm	6.3 x 0.8 mm	1	–	233226
						
11	Faston	8 mm	6.3 x 0.8 mm	1	–	233234

DIN 41612 / IEC 60603-2 Connectors

Type H11 Female

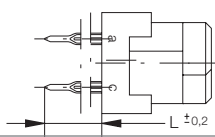
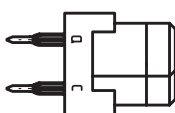

Ordering Information

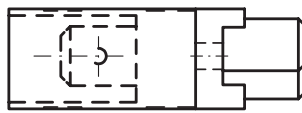
No. of Pins	Termination	Term. Length	Pin Dimensions	Class	Pressfit Zone	Part Number
 11	Pressfit	4 mm	0.6 x 0.6 mm	1	2.5 mm	913738
 11	Pressfit	6 mm	0.6 x 0.6 mm	1	2.5 mm	424655
 11	Solder	4.3 mm	0.6 x 0.6 mm	1	–	424654
 11	Faston	8 mm	6.3 x 0.8 mm	1	–	243246

DIN 41612 / IEC 60603-2 Connectors

Type H15

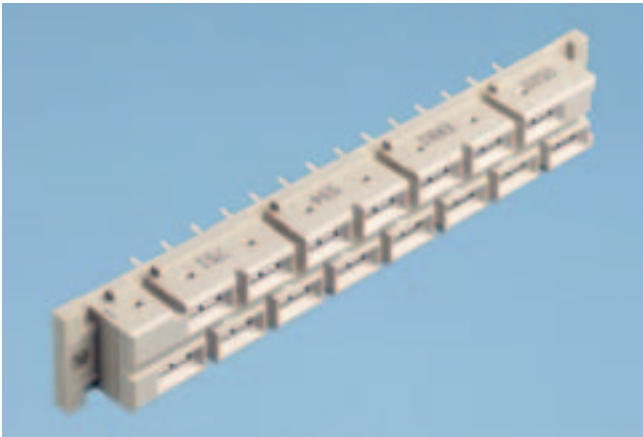

Dimensional Drawing Solder Male

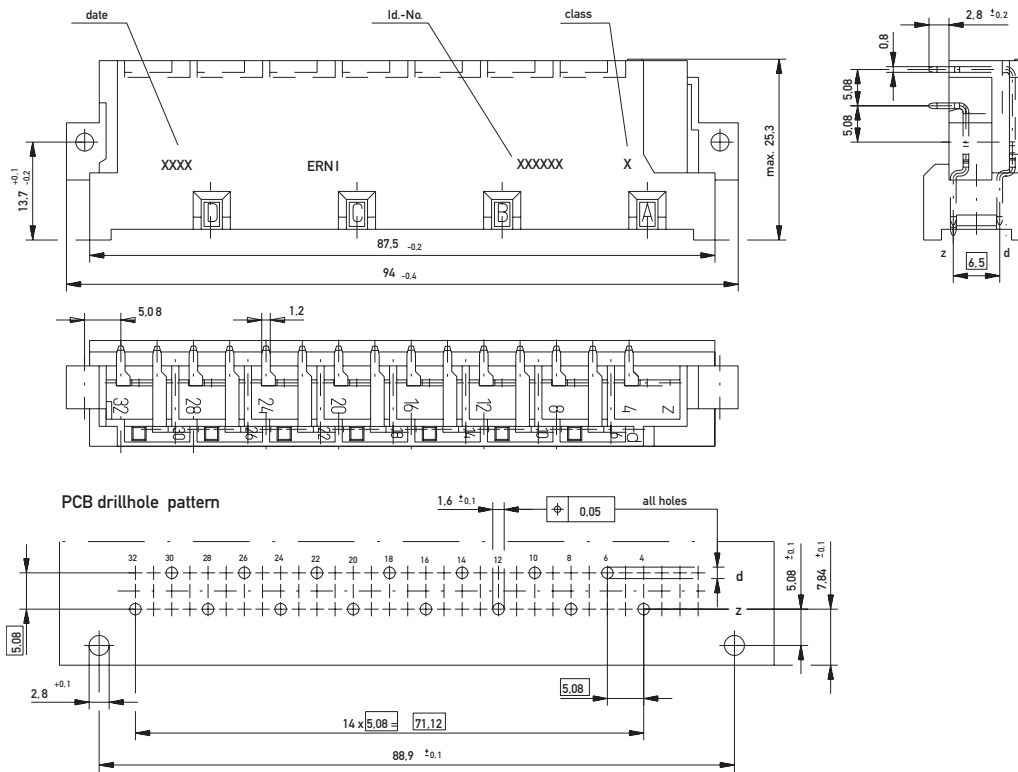



Dimensional Drawing Faston Male

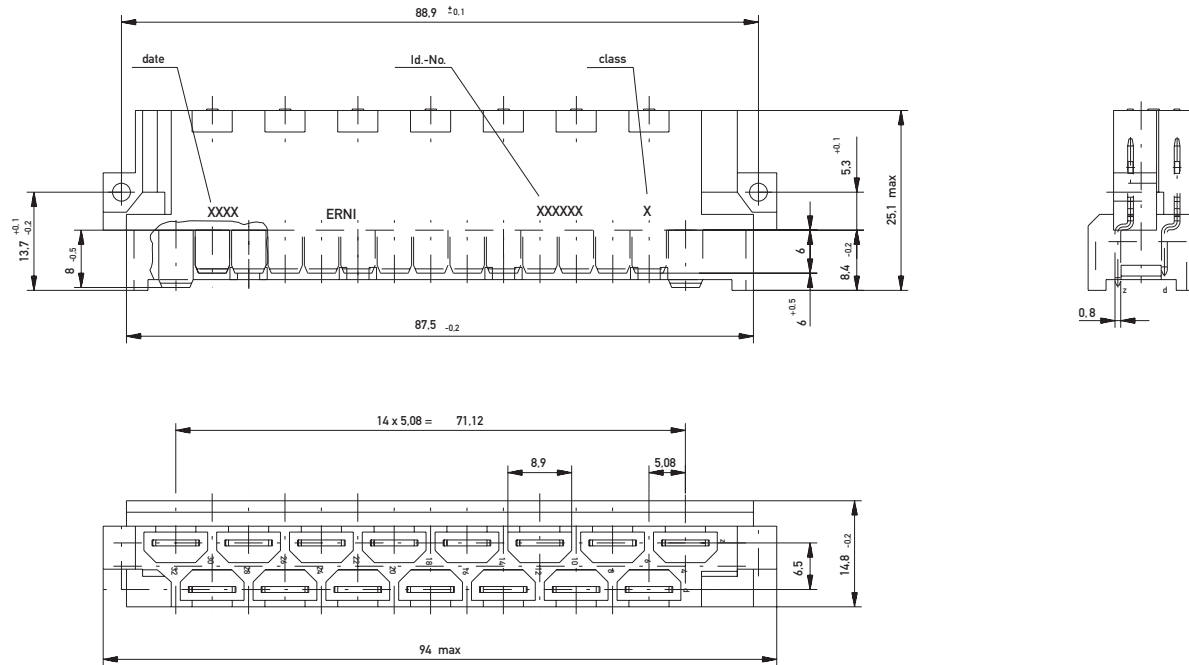

Dimensional Drawing Pressfit Female

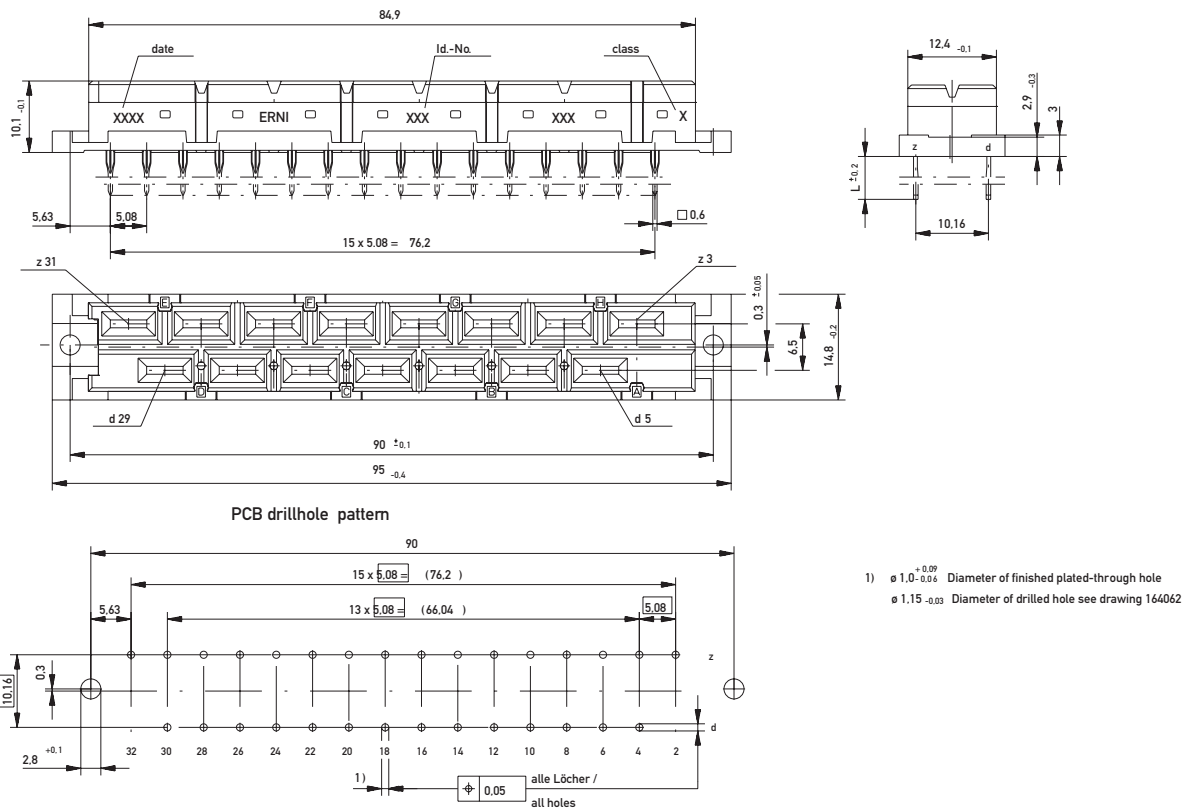

DIN 41612 / IEC 60603-2 Connectors

Type H15 Male



Ordering Information

No. of Pins	Termination	Term. Length	Pin Dimensions	Class	Pressfit Zone	Part Number
15	Solder	2.8mm	0.8 x 1.2 mm	1	1	413638
15	Solder	2.8mm	0.8 x 1.2 mm	1	1	414575
15	Solder	2.8mm	0.8 x 1.2 mm	1	1	413169

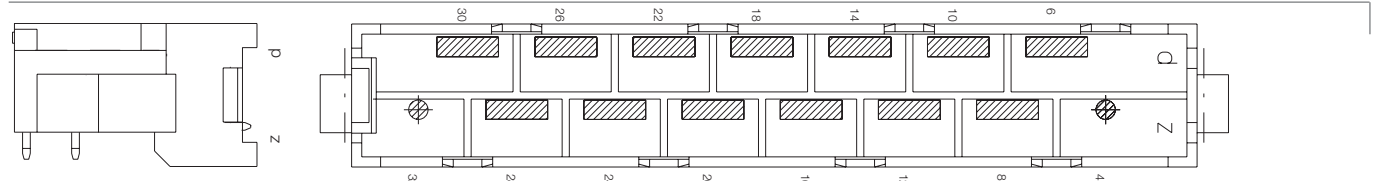
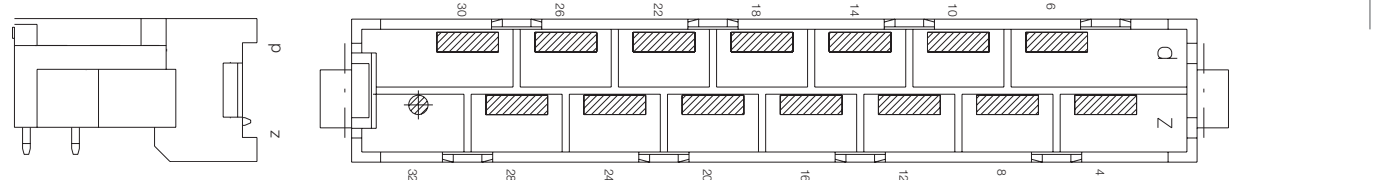
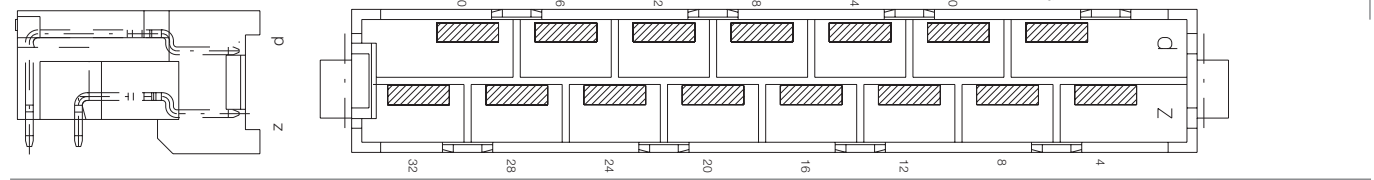

DIN 41612 / IEC 60603-2 Connectors

Type H15 Male



Ordering Information

No. of Pins	Termination	Term. Length	Pin Dimensions	Class	Pressfit Zone	Part Number
15	Faston	8 mm	6.3 x 0.8 mm	1	-	413637
15	Faston	8 mm	6.3 x 0.8 mm	1	-	414574
15	Faston	8 mm	6.3 x 0.8 mm	1	-	413168

DIN 41612 / IEC 60603-2 Connectors

Type H15 Female

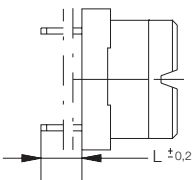
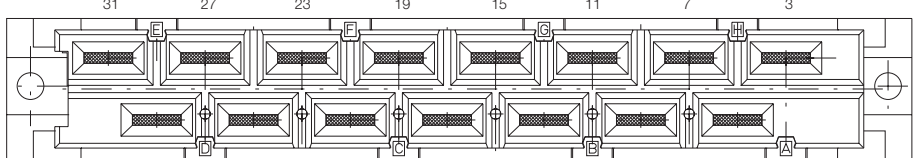
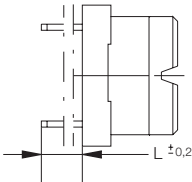
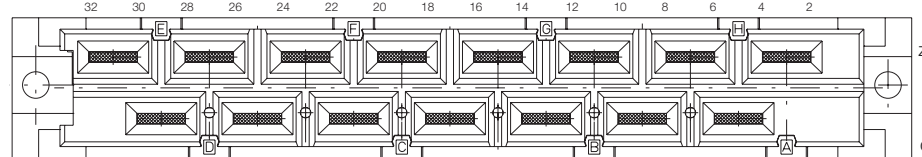

Ordering Information

No. of Pins	Termination	Term. Length	Pin Dimensions	Class	Pressfit Zone	Part Number
 15	Pressfit	6 mm	0.6 x 0.6 mm	1	2.5 mm	
						594752
 15	Solder	4.3 mm	1.2 x 0.6 mm	1	-	
						594750
 15	Solder	4.3 mm	0.6 x 0.6 mm	1	-	
						594751
 15	Faston			1	-	
						413170



Dimensional Drawing Faston/Solder Male

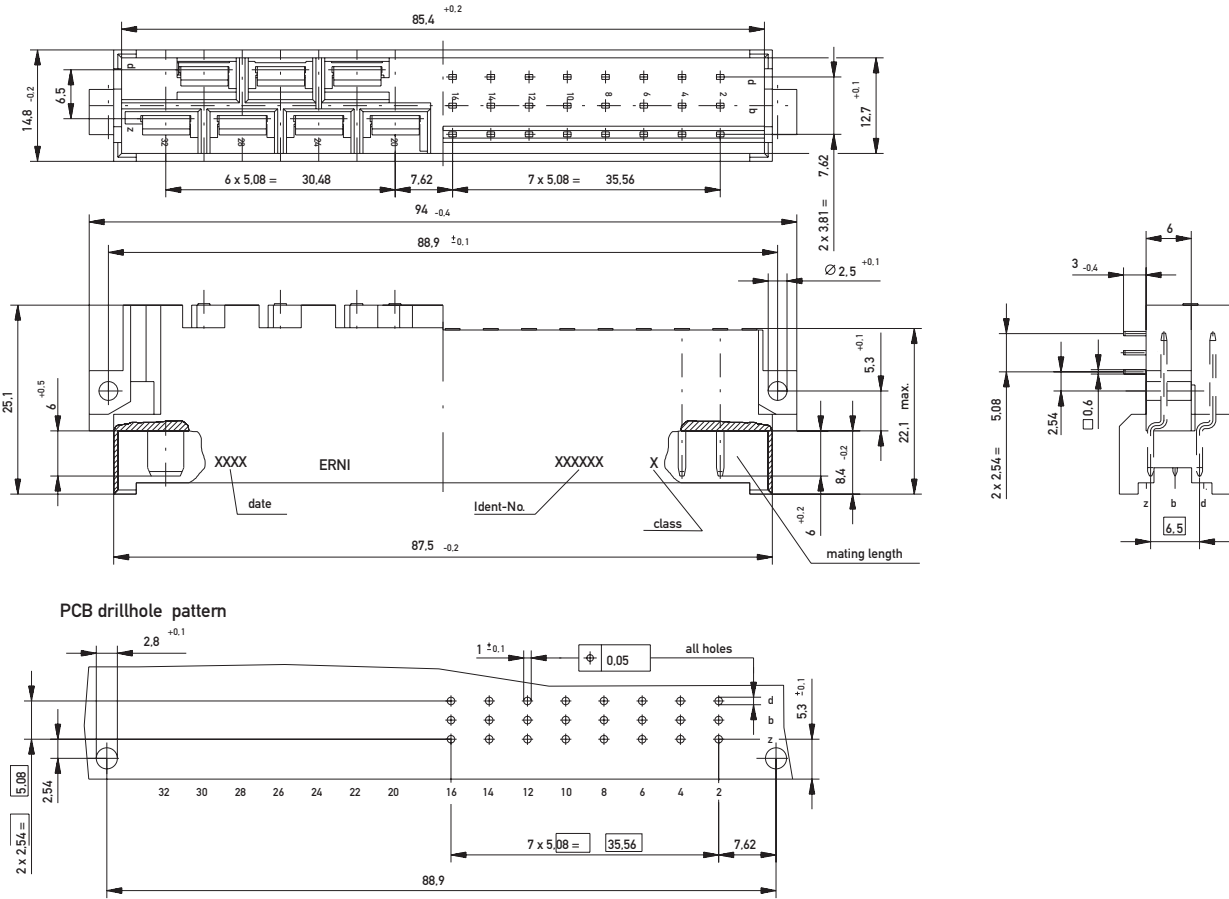



Dimensional Drawing Solder Female

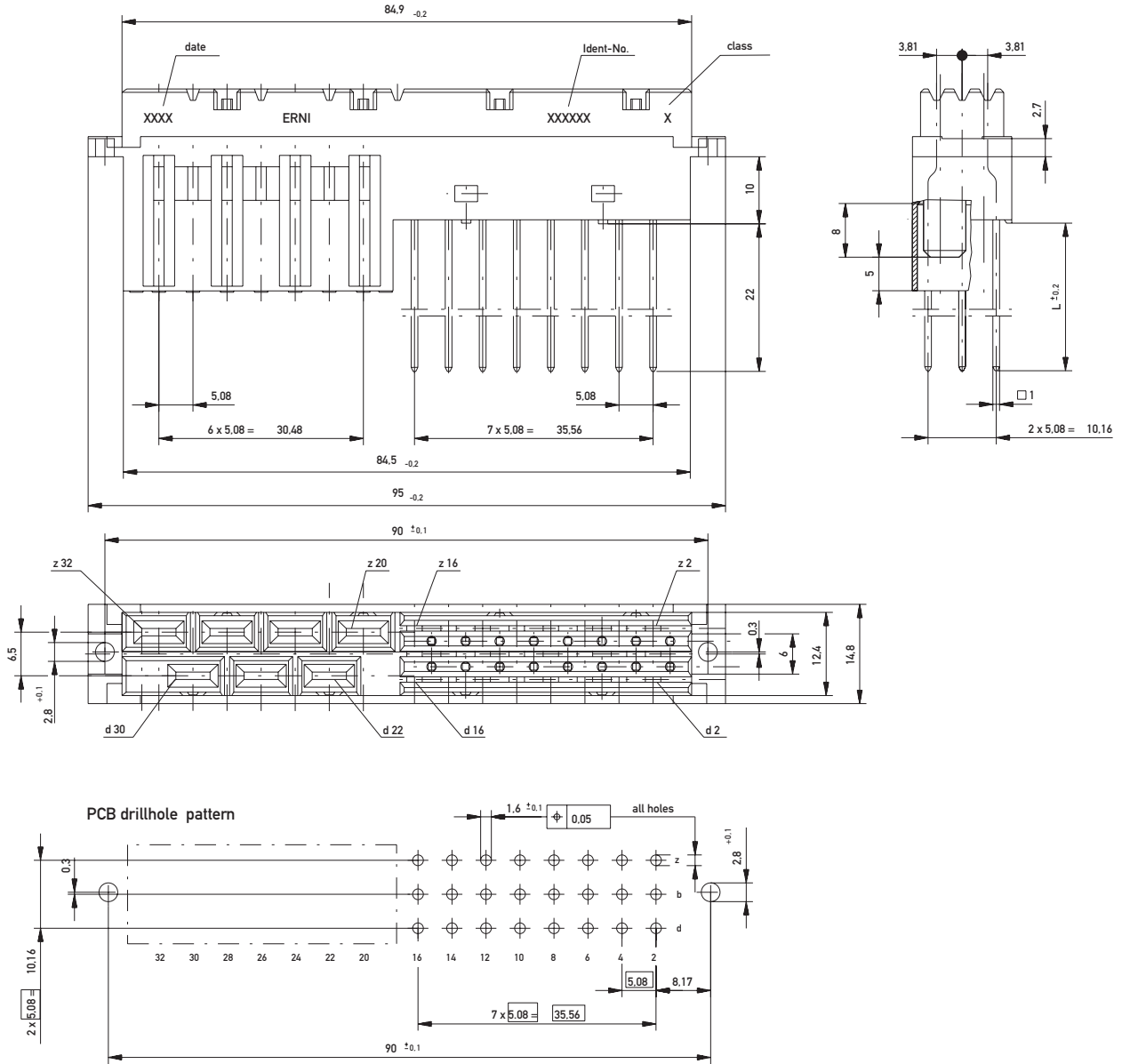

DIN 41612 / IEC 60603-2 Connectors

Type H7/F24 Male

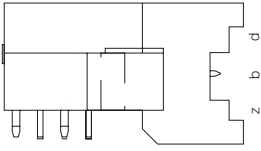
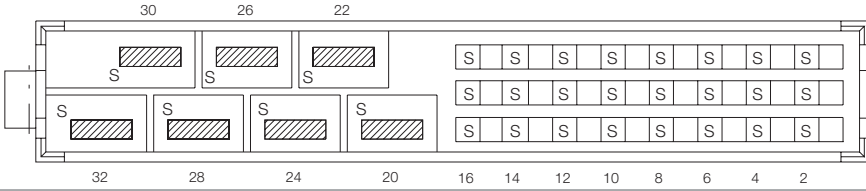
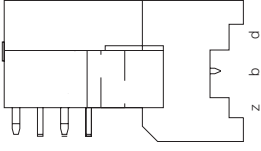
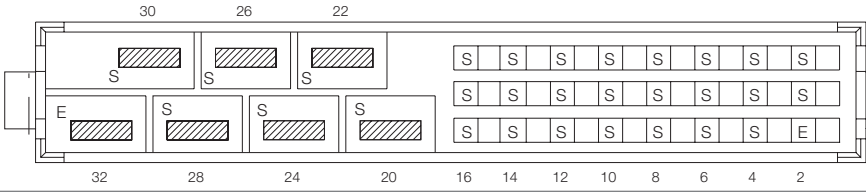
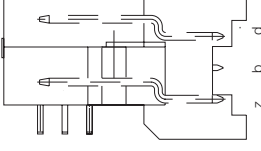
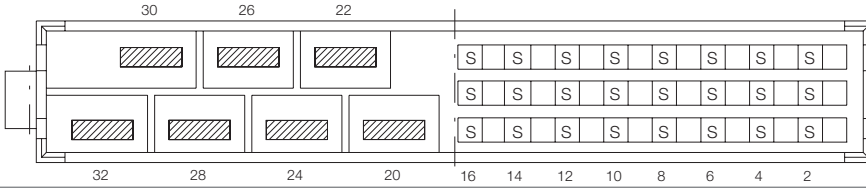
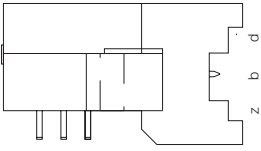
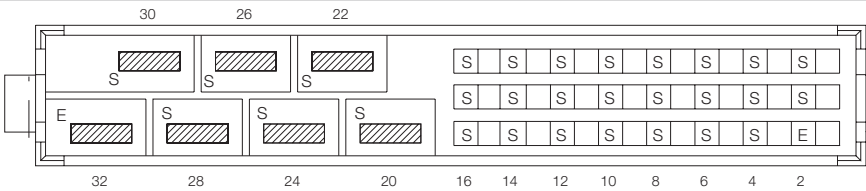

Ordering Information

No. of Pins	Termination	Term. Length	Pin Dimensions	Class	Pressfit Zone	Part Number
	Solder	3 mm		1	-	413640
						593254
	Solder	3 mm		1	-	413172
						593250
	Faston/Solder	3 mm		2	-	593252
						413171
	Faston/Solder	3 mm		1	-	413171
						593248

DIN 41612 / IEC 60603-2 Connectors

Type H7/F24 Female



Ordering Information

No. of Pins	Termination	Term. Length	Pin Dimensions	Class	Pressfit Zone	Part Number
7-24	Faston/Solder	22 mm	H: 6.3 x 0.8 mm; F: 1 x 1 mm	1	–	413173
7-24	Faston/Solder	22 mm	H: 6.3 x 0.8 mm; F: 1 x 1 mm	2	–	593256

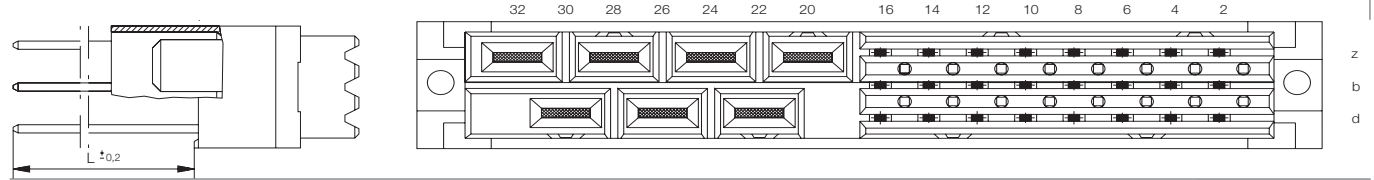

DIN 41612 / IEC 60603-2 Connectors

Insulation Displacement Connector (IDC)



ERNI insulation displacement connectors similar to DIN 41612/IEC 60603-2 are suitable for assembling flat ribbon cables.

The female connectors are available for the standard pin numbers 64 and 96.

- Female connectors size C, 64-pin, rows a c.
- Female connectors size C, 96-pin, rows a b c.

The flat ribbon cable fixed to the cable guide is pressed onto the insulation displacement contacts of the female connector using an easy to use tool (pliers or hand lever press). A reliable connection is made through a double insulation displacement contact. The pointed ends puncture the insulation material of the flat cable and make contact with the conductors at high pressure.

Dimensional Drawing

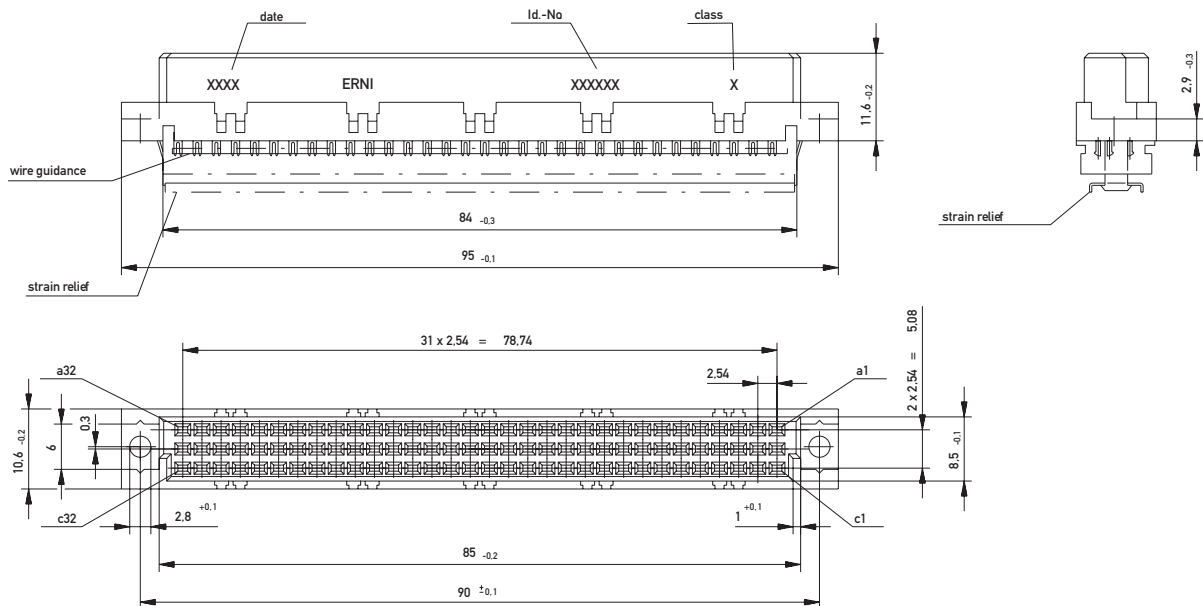

DIN 41612 / IEC 60603-2 Connectors

Insulation Displacement Connector (IDC)

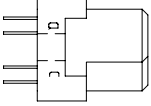
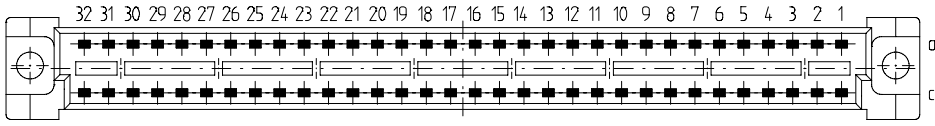
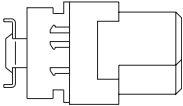
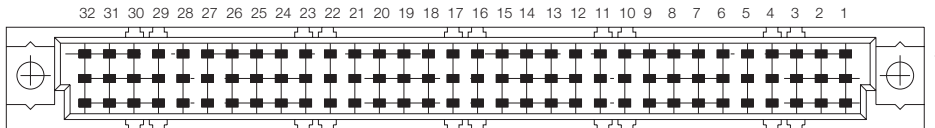

Ordering Information

No. of Pins	Termination	Term. Length	Pin Dimensions	Class	Pressfit Zone	Part Number
						
64	IDC	-	-	2	-	594470
						
96	IDC	-	-	1	-	123905

DIN 41612 / IEC 60603-2 Connectors

Insulation Displacement Connector (IDC)



Application example for DIN-IDC connectors

For the use of female connectors with insulation displacement contacts as interface connectors from the wiring side of the rack ERNI has developed special shrouds. These Shrouds are available in various heights.

(All dimensions in mm)

Connector Type	Contact length	PCB thickness	Shroud height	Part-No.
	A	B	C	Shroud
C, R	13	1,6	12,5	414715
	13	2,4	12,5	414715
	13	3,2	11,4	434286
	17	2,4	16,0	414219
	17	3,2	15,2	333139
	20	3,2	18,2	413971

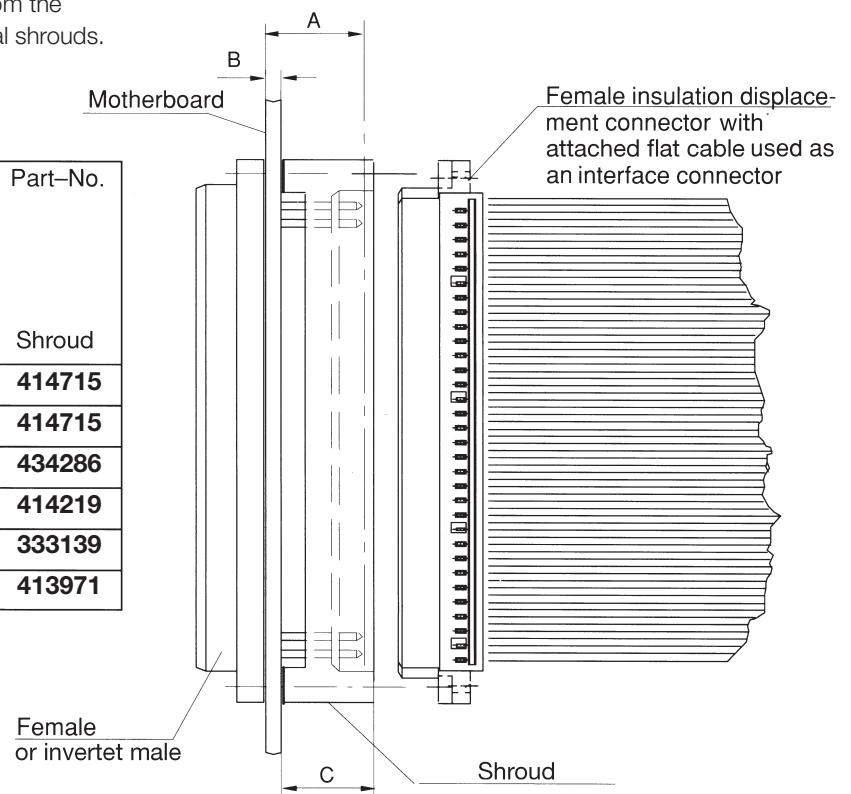

The female insulation displacement connector can be screwed to the shroud with a cheese-head tapping screw B2.2 x 9.5 DIN 7971.





Ordering details tools

Description	Fig. no.	Part no.
Assembly tool with adjustable stop	1	473188

Description	Fig. no.	Part no.
Hand lever press	2	473200
Pliers with various accessories. Complete set in a case	3	424623

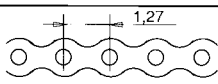
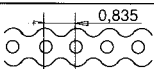
Ordering details for flat ribbon cables and accessories

Number of pins	Descriptions for flat ribbon cables	Length of a cable reel	Part. no. for 1 meter
64-pin 	grey with a red identification wire AWG 30	61m	414068
	color coded AWG 30	61m	414082
96-pin 	grey with a red identification wire AWG 30	61m	913049

Description	Remarks	Part.no.
Tension relief clamp 	for a 96-row female connector size C	033055

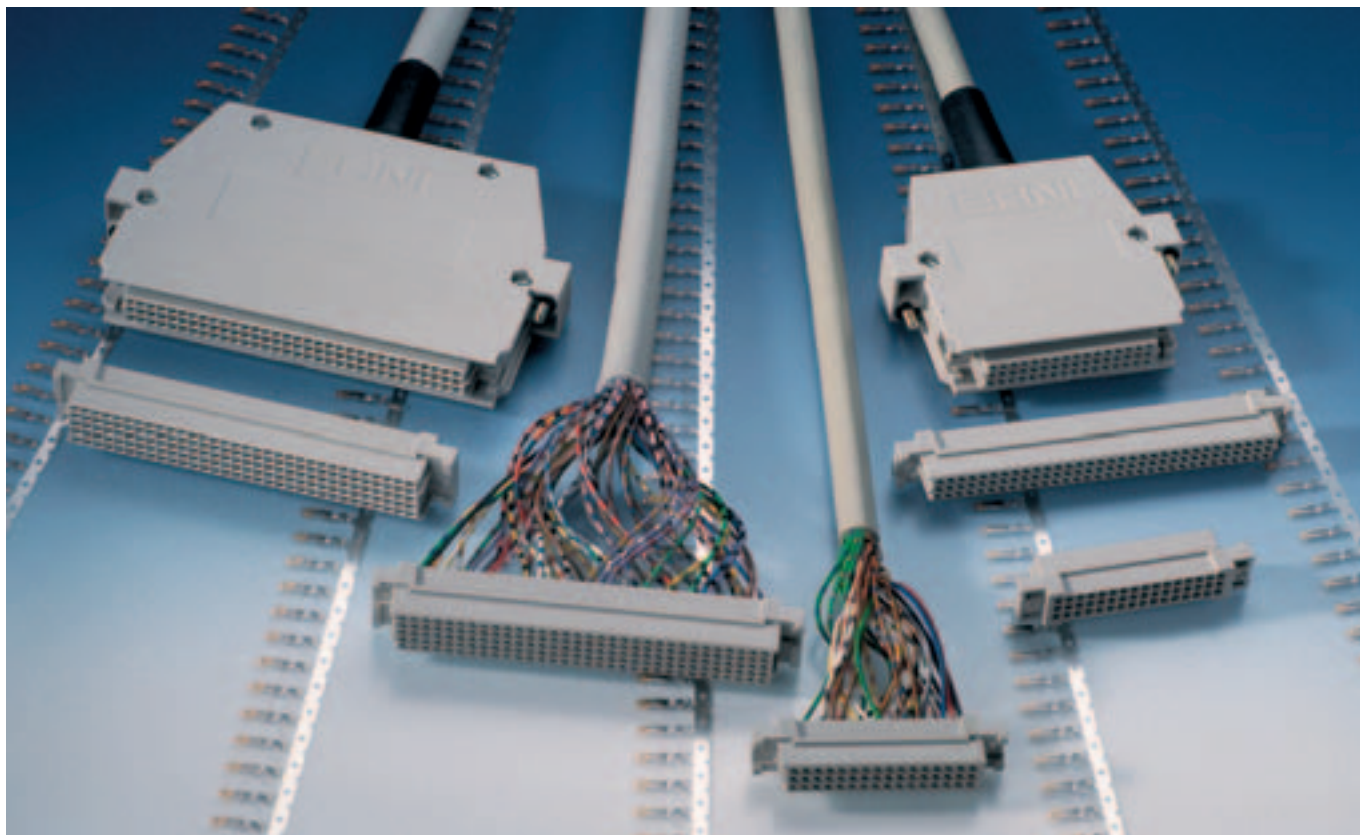

General

Where the termination of interconnecting cables is required, crimp snap-in termination represents an efficient wiring method.

Crimp snap-in contacts are connected to the wires by use of suitable crimping tools. The contacts are supplied either singly or suspended from a strip.

Contacts efficiently assembled in this manner snap into the crimp snap-in mouldings provided, thus forming ready equipped connectors.

Crimp snap-in connectors are particularly suitable for flexible wiring with varying numbers of pins.

Hand tools or automatic crimping machines are available for crimping.

Main features

- Available housing sizes
 - size C with 96 contact cavities, rows abc
 - size C/2 with 48 contact cavities, rows abc
 - size E 160 with 160 contact cavities, rows abcde
 - Special and mixed designs
- Cantilever female contacts for constant contact resistance
- Approved female contact design in the mating zone
- Assembly with standard tools
- Suitable for the ERNI interface connector system (connector housings for DIN connectors on front panel and wiring sides)
- Suitable for wire of AWG 28 – 20
Wire cross section 0.08 – 0.56 mm²
- Contacts can be detached from the female connector moulding with a simple extraction tool.

DIN 41612 / IEC 60603-2 Connectors

Crimp snap-in Connectors (CST)



Female connector housing size C, 96 contact cavities

Mating and installation conditions as per DIN 41612/IEC 60603-2

Dimensional drawings

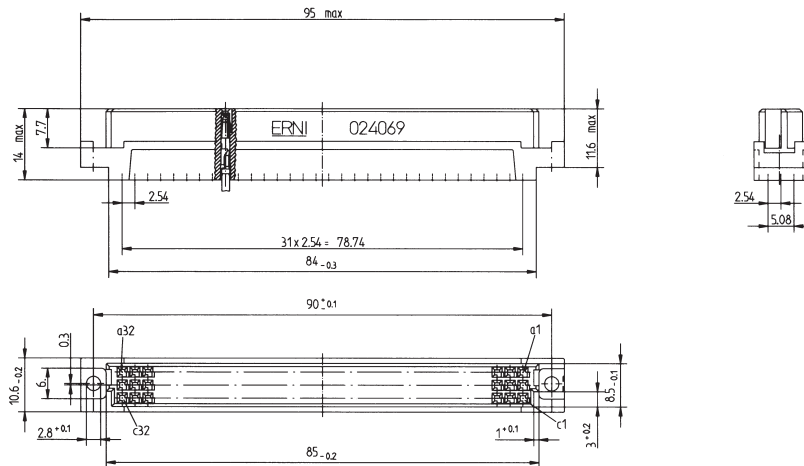

Ordering details

Description	Part no.
Empty housing size C-96	024069

Female connector housing size C/2, 48 contact cavities

Dimensional drawings

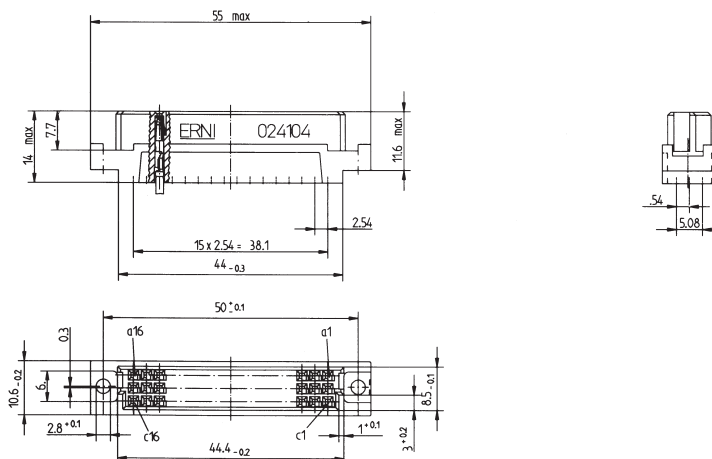

Ordering details

Description	Part no.
Empty housing size C/2-48	024104

DIN 41612 / IEC 60603-2 Connectors

Crimp snap-in Connectors (CST)



Female connector housing size E 160, 160 contact cavities

Dimensional drawings

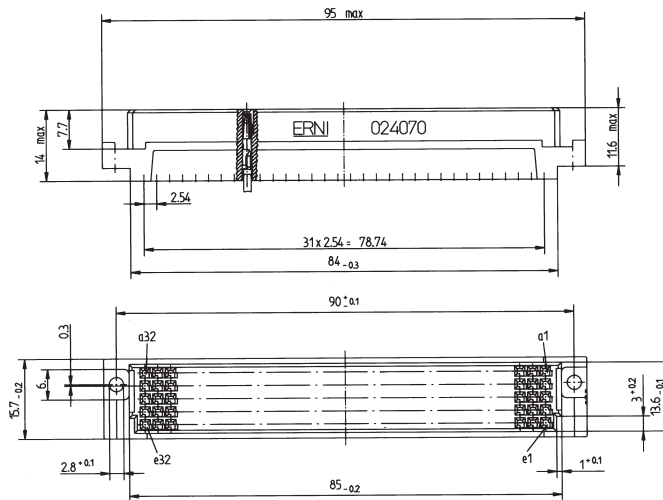

Ordering details

Description	Part no.
Empty housing size E160-160	024070

Application example for customized version



Interesting solutions arise in the application of crimp contacts.

We have developed a 70-pin female connector housing together with a well-known manufacturer of programmable controllers.

We wish to use this example to illustrate that we are constantly developing components in cooperation with our customers.

Perhaps your company also has applications which you may wish to discuss with one of our field sales engineers.

Crimp contacts for female connector housings

Dimensional drawings

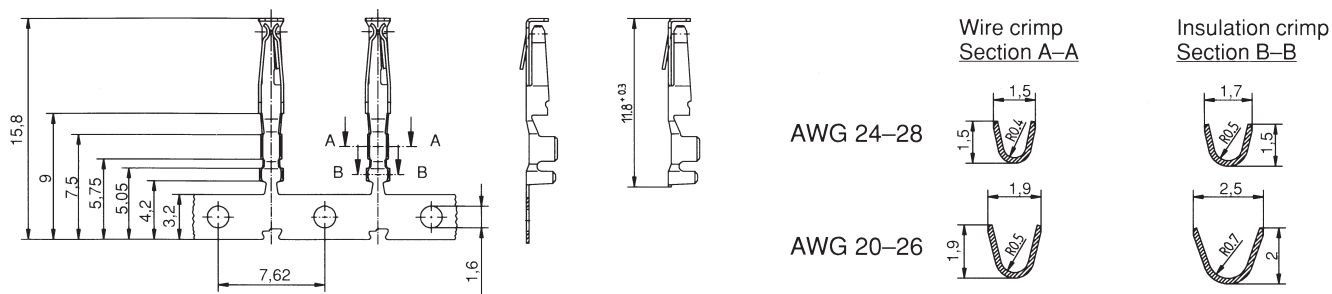

Ordering details

Description	Wire cross section		Perform. level	Part. no. and size		
	AWG	mm ²		Contact reel 10.000 contacts	Contact reel 500 contacts	Loose contacts 100 per bag
Crimp contacts	24-28	0,22-0,08	207	234065	234066	234067
	20-26	0,56-0,14	207	234062	234063	234064

Crimp contacts from ERNI are characterized by their precision.

The two opposite spring legs guarantee a constant contact.

Precise positioning of the contacts in the female connector housing is achieved by using of the box-type design in the front zone of the contact.

A spring-loaded barb on the side locks the contacts in the female connector housing.

This locking can be undone easily with a small tool.



DIN 41612 / IEC 60603-2 Connectors

Crimp snap-in Connectors (CST)



Assembly tools for DIN crimp connectors

Technical data and ordering details

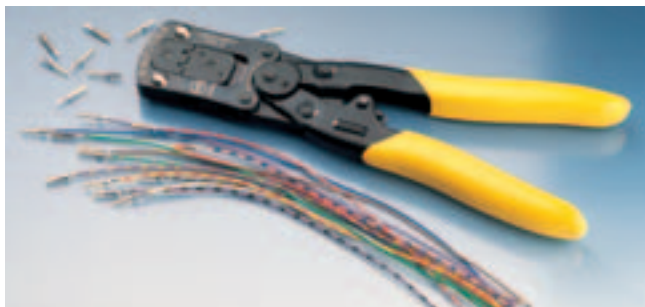

Hand tool for loose contacts AWG 20 – 28 0,56 – 0,08 mm ²	Part no.
	014374



Hand tool for contact reels with 500 contacts including reel holder and adjustable feed	Part no.
	014375



Disassembly tool for all AWG ranges	Part no.
	471555

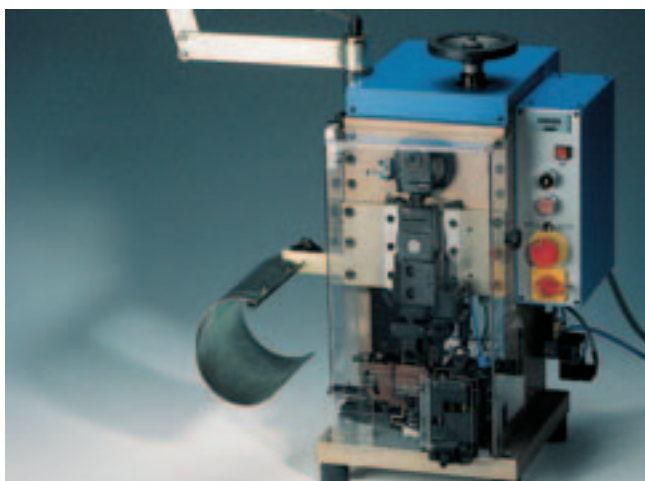

Crimp presses are available for the automated crimping. Please refer to our ERNI-team when purchasing this press.

The interface connector system from ERNI for the front panel and wiring sides

Front panel
with guide elements

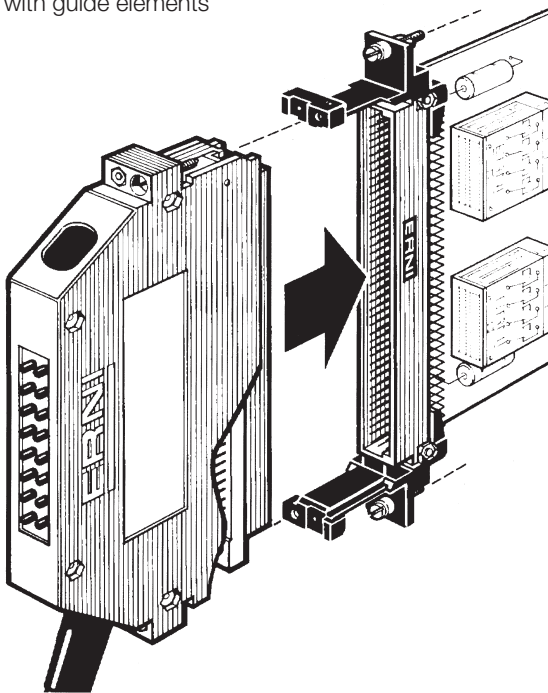

Wiring side
shroud with guide elements

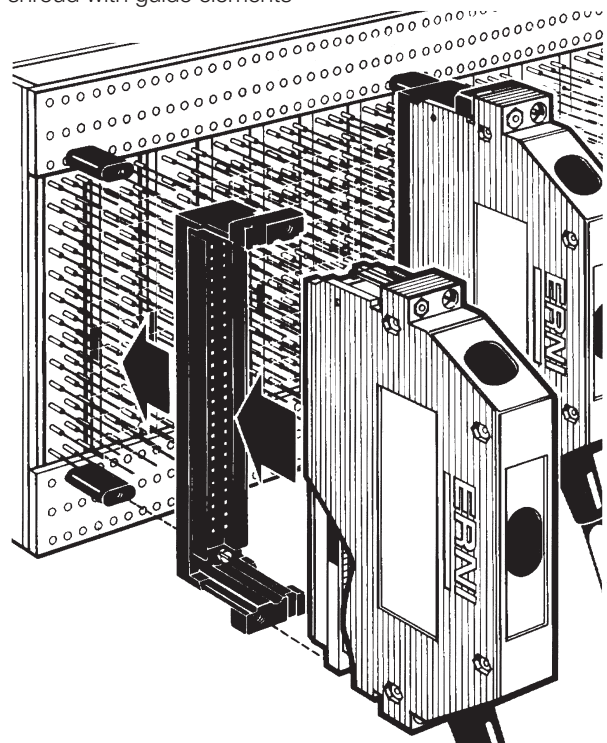

The female connector housings of size C, C/2 and E 160 fit into the cable connector housings of series KSG 173 and KSG 193.

For installation on the front of the rack there are guide elements for mounting in the front panel and guide elements which can be mounted on the rack without a front panel.

Interface connection is possible from the wiring side with guide elements and shroud.

Do ask for our technical documentation or contact one of our offices or field sales engineers.

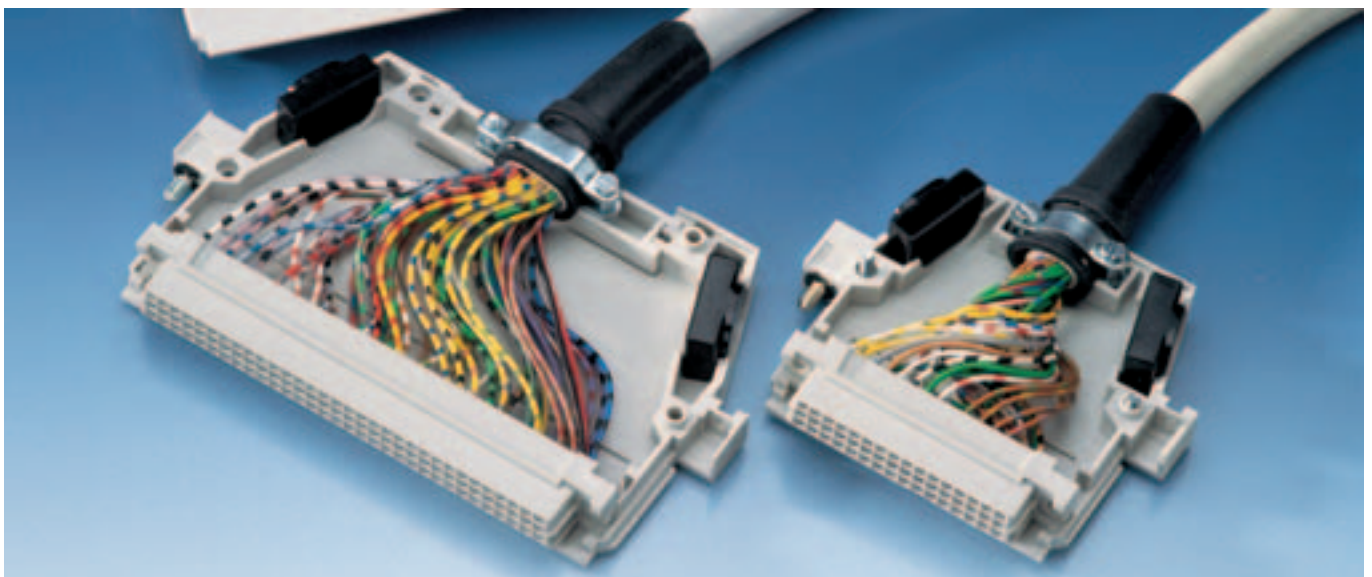

Shroud

for mounting on PC Boards

with connectors size C, R, CD 128, RD 128, E 160, TE 160

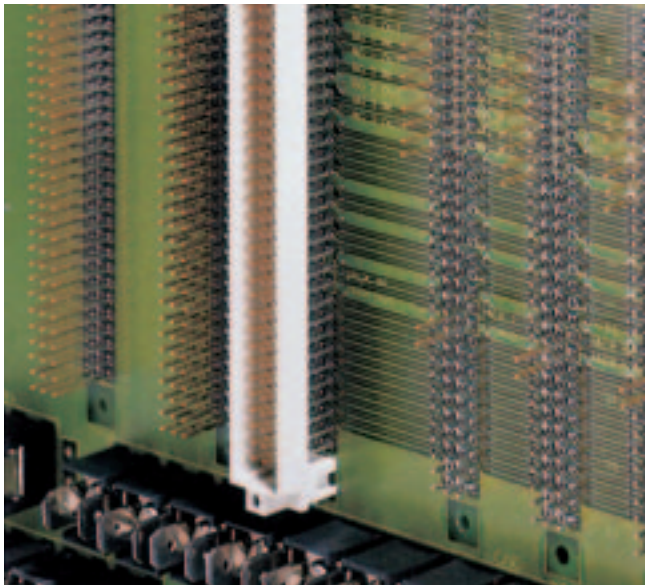

Interface on the wiring side of a control system with the aid of interface connectors play an important role in signal transfer. One of the many advantages of the press-fit technique is that the interface connection to the wiring side can be made easily. This connection to the wiring side of a PC Board loaded with press-fit connectors can be accomplished by simply mounting shrouds to the rear (wiring) side. ERNI has developed shrouds with varying heights for the C, R, CD 128, RD 128, E 160 and TE 160 sizes.

For more information on the ERNI shrouds, please contact your field sales engineers.

Ordering Information

(All dimensions in mm)

PCB thickness	Mating area	Total height	Contact length	Part-No. Shroud			
				E 160 TE 160	CD 128 RD 128	C 96 R 96	C/2-48 R/2-48
LP	C	B	A				
2.4	6.0	11.0	13	064729	064728	433215	034798
3.2	5.2						
2.4	5.6	11.4	13	064586	064584	434286	034797
3.2	4.8						
1.6	6.0	11.8	13	064708	064713	013275	034702
2.4	5.2						
3.2	4.4						
1.6	5.3	12.5	13	064585	064583	414715	034799
2.4	4.5						
1.6	4.2	13.6	13	064709	064714	014145	034796
2.4	5.8	15.2	17	064710	064715	333139	034800
3.2	5.0						
1.6	5.8	16.0	17	064711	064716	414219	034801
2.4	5.0						
3.2	4.2						
2.4	5.8	18.2	20	064712	064717	413971	034802
3.2	5.0						

Please consider sufficient overlapping length.

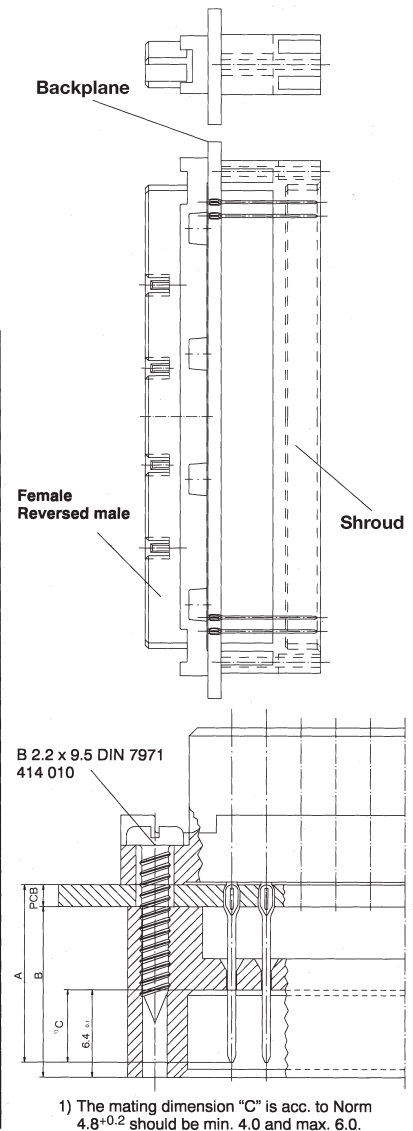

1) The mating dimension "C" is acc. to Norm 4.8^{+0.2} should be min. 4.0 and max. 6.0.

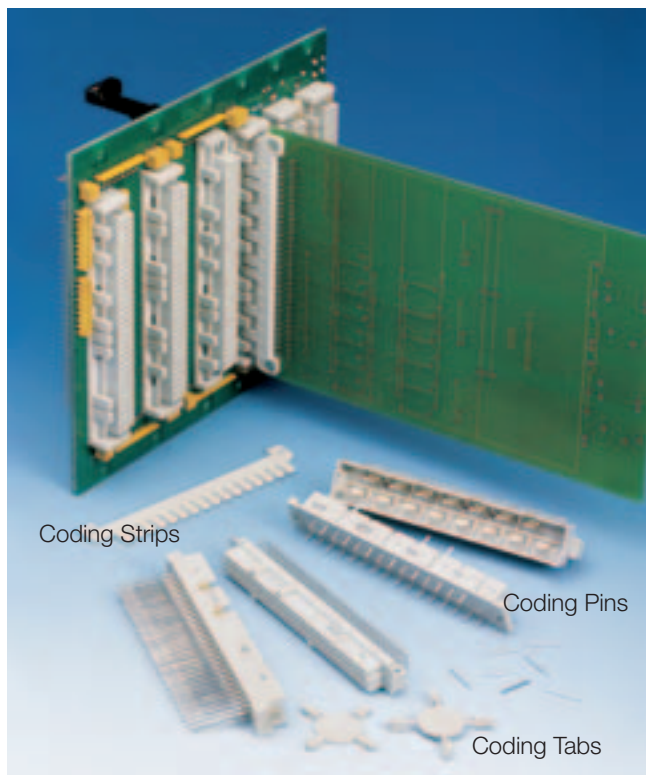

General

In order to ensure proper coding of a DIN 41612 connector and thus protect the valuable components within an electronic device, ERNI offers a variety of coding systems.

- Coding with Coding **Strips**

Separate coding strips are attached directly to each connector half with no additional modular space required in the 19" rack system.

- Integrated Coding with Coding **Tabs**

The coding tabs are plugged into side slots on the female connector while corresponding notch areas on the male connector are removed with coding pliers.

- Integrated Coding with Coding **Pins**

The coding pins are inserted into the predrilled holes on the female connector and drill holes are required on the recess hole points on the male connector at the corresponding locations.

Determining the number of coding possibilities

To maintain connector integrity, the maximum recommended number of coding possibilities is based on using only 1/2 the total available coding slots. For example, in the case of using the coding strips where there are 16 available coding tabs per strip, no more than 8 of the tabs should be removed.

Under this system, the following table Shows the number of coding possibilities for each of the three coding systems.

Connector Style	Coding Strips			Coding Tabs Female Connectors	Coding Pins Female Connectors
	Female and Inverse Male Connectors ¹⁾				
	F	FL	UE		
B/3, C/3, Q/3, R/3	–	–	–	6	–
B/2, C/2, Q/2, R/2	–	–	–	20	–
B	12870	12870	12870	70	–
C	12870	12870	12870	70	–
D	12870	12870	12870	20	12870
E	12870	12870	12870	–	>12870
F	–	–	–	–	>12870
H11	12870	12870	–	252	–
H15	–	–	–	70	20
H7/F24	–	–	–	–	70
M	12870	12870	12870	70	–
P	–	–	–	70	–
Q, R	12870	12870	12870	70	–
CD128, RD128, E160, TE160	12870	12870	12870	70	–

¹⁾ Male connectors and inverse female connectors require coding bar "M"



Coding Strips

Coding Strip style F

Female connectors B, C, D, E, H11, M, CD128, E160
Inverse Male connectors Q, R, RD128, TE160

For use with female connectors or inverse male connectors as per DIN 41612 in a 19" rack mounting scheme.

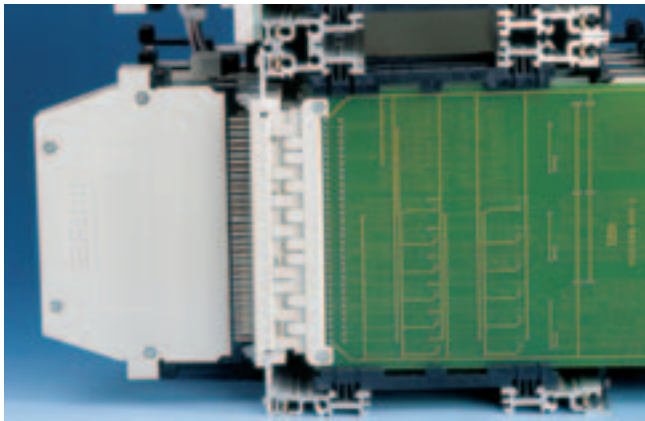

Coding Strip F mounted in a 19" sub-rack.

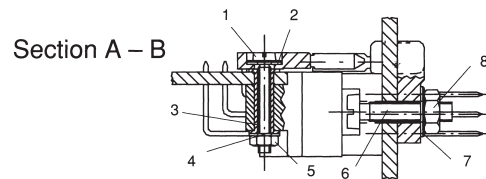
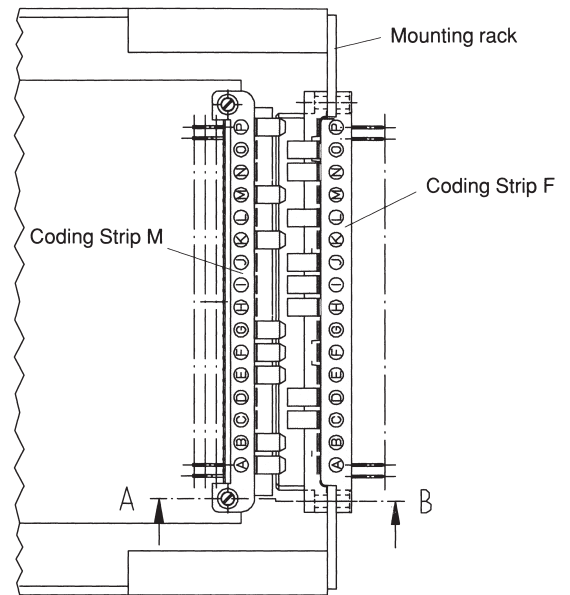

See table on page 197 for reference.

Coding Strip style FL

Female connectors B, C, D, E, H11, M, CD128, E160
Inverse Male connectors Q, R, RD128, TE160

For use with female connectors or inverse male connectors as per DIN 41612 in a backplane mounting scheme.

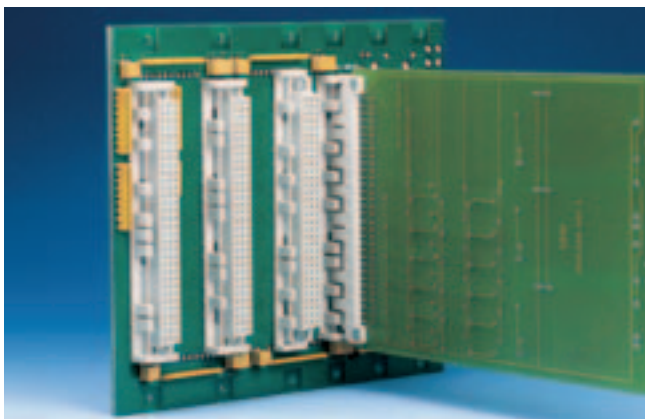

Coding Strip FL mounted on a backplane.

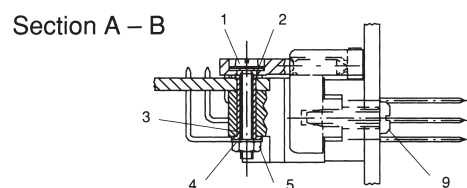
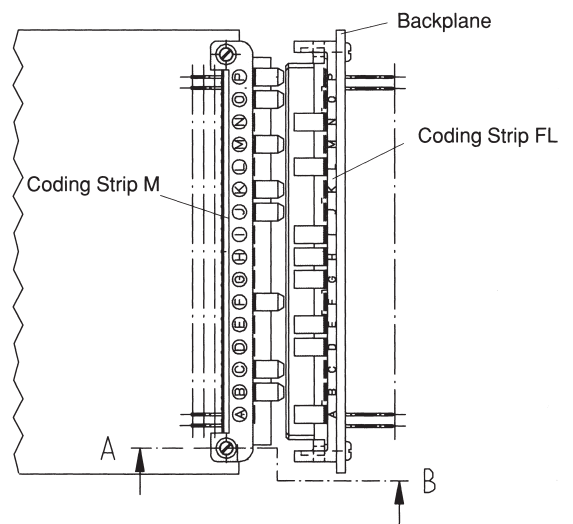

See table on page 197 for reference.



Coding Strip style UE

Female connectors B, C, D, E, M, CD128, E160
Inverse Male connectors Q, R, RD128, TE160

For use with female connectors or inverse male connectors as per DIN 41612 in a backplane mounting scheme together with peripheral connections.

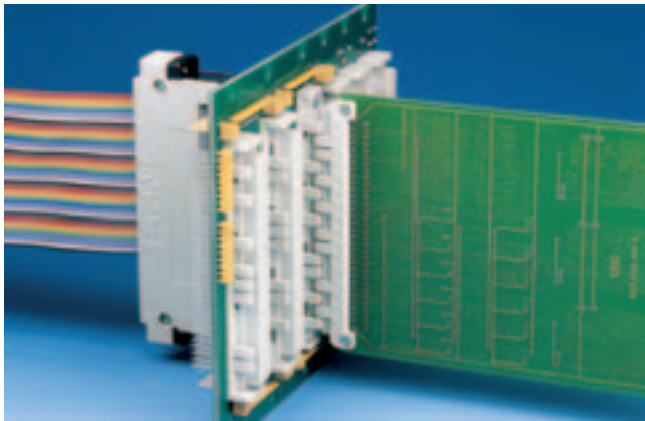

Coding Strip UE mounted on a backplane with a peripheral interface.

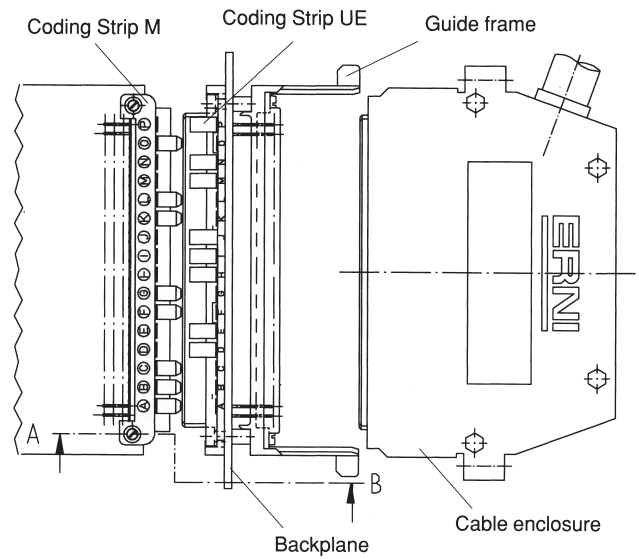

Section A – B

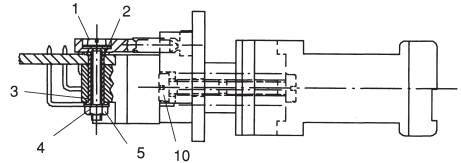

See table on page 197 for reference.

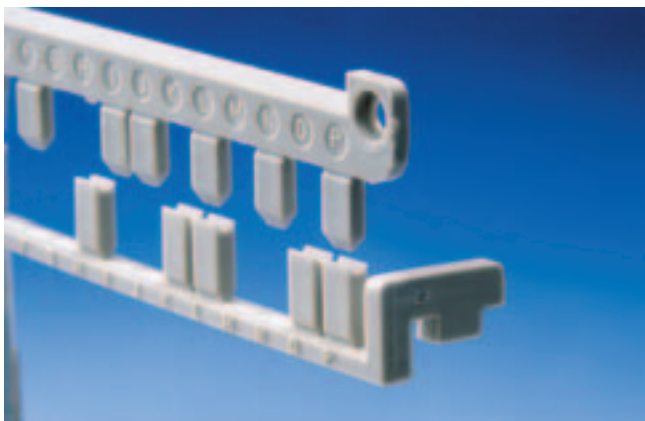



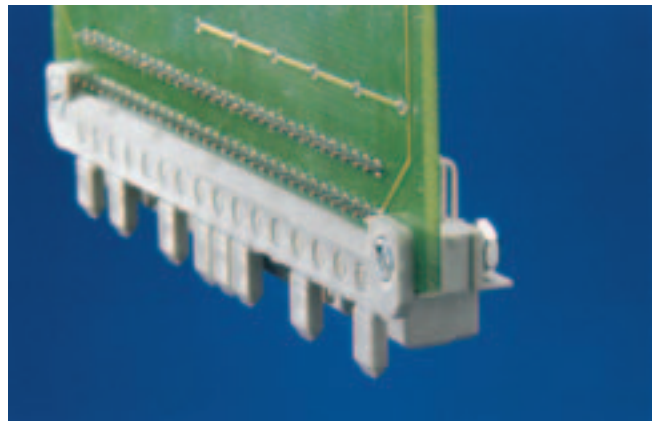

Ruggedized coding tabs on the coding strips can withstand a strain of up to 250 N even when misaligned mating occurs.

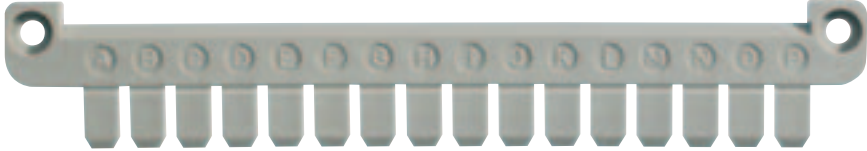

When coding the plug-in module, the coding strip M is always used. The M strips' coding tabs are identified with the letters A, B, C, . . . , P.

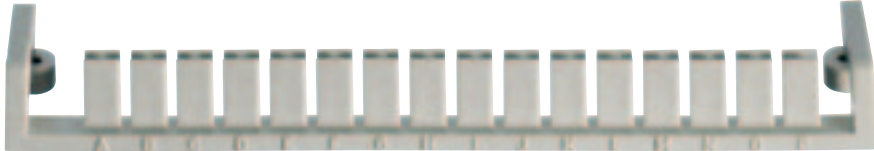
Ordering Instructions for Coding Strips

Description	Material	Remarks	Part Number
			
Coding Strips M Male connectors B, C, D, E, H11, M, CD128, E160 Inverse Female connectors Q, R, RD128, TE160	PBTP 30% GF	Coding Strips M should be mounted after soldering.	083502
			
Coding Strips F Female connectors B, C, D, E, H11, M, CD128, E160 Inverse Male connectors Q, R, RD128, TE160	PBTP 30% GF	The Coding Strips must be screwed or riveted together with the connector; no additional drill holes are needed.	083504
			
Coding Strips FL Female connectors B, C, D, E, H11, M, CD128, E160 Inverse Male connectors Q, R, RD128, TE160	PBTP 30% GF	The Coding Strips must be screwed or riveted together with the connector; no additional drill holes are needed.	083506
			
Coding Strips UE Female connectors B, C, D, E, M, CD128, E160 Inverse Male connectors Q, R, RD128, TE160	PBTP 30% GF	The Coding Strips must be screwed or riveted together with the connector; no additional drill holes are needed.	414705

Mounting Hardware for Coding Strips (*not included with coding strips*)

Pos ¹⁾	Description	Size	Pos ¹⁾	Description	Size
1	Fillster head screw	M 1.6x12 DIN 84	6	Fillster head srew	M 2.5x12 DIN 84
2	Washer	A 1.8 DIN 125	7	Washer	2.7 DIN 125
3	Rivet		8	Hexagonal nut	M 2.5 DIN 934
4	Spring washer	A 1.7 DIN 137	9	Sheet metal srew	B 2.2x9.5 DIN 84
5	Hexagonal nut	M 1.6 DIN 934	10	Fillster head sheed	M 2.5x10 DIN 84

¹⁾ Position numbers are from sketches on pages 195 and 196.



Coding Taps

Female connectors B/3, C/3, B/2, C/2, B, C, D, H11, H15, M, CD128, E160
 Inverse Female connectors Q/3, R/3, Q/2, R/2, P, Q, R, RD128, TE160



The coding tabs are inserted into existing slots on the female connector. By using coding pliers, the corresponding pre-notched area on the male connector is recessed.

The number of coding tab locations available depends on the size and style of the connector.

To maintain connector stability, the maximum recommended number of coding possibilities is based on using only 1/2 the total available coding slots.

Thus the specific number of coding possibilities is shown in the table on page 194.

This coding system is supplied in a star-shaped assembly with 4 coding tabs.

Ordering Instructions

4 Coding tab assembly:

Female connectors
 B/3, C/3, B/2, C/2, B, C, D, M, CD128, E160
 Inverse Female connectors
 Q/3, R/3, Q/2, R/2, P, Q, R, RD128, TE160

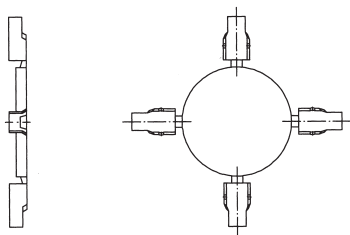

Part number: **033014**

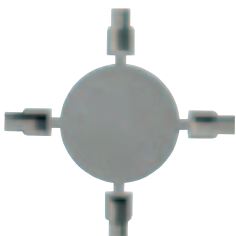

4 Coding tab assembly:

Female connectors
 H11, H15

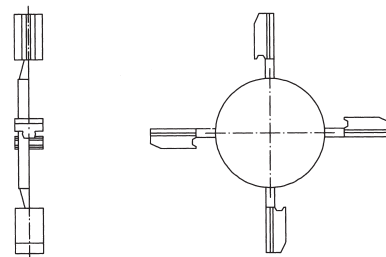

Part number: **434878**

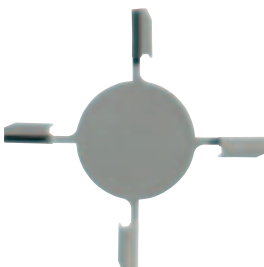

Coding pliers

For removing the coding position on the male connector

Part number: **473270**

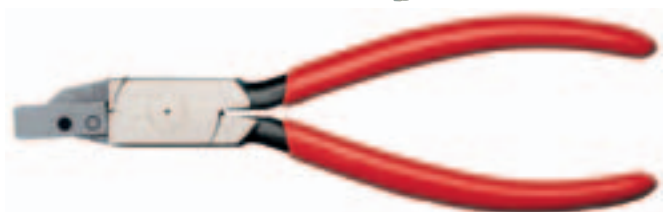

Coding Pins

Female connectors D, E, F, H15, H7/F24



The coding pins are inserted with an insertion tool into predrilled holes located between the contact rows on the female connector. Corresponding holes must then be drilled on the male connector. Recessed hole points on the male connector provides alignment for drilling the corresponding holes.

Coding Instructions

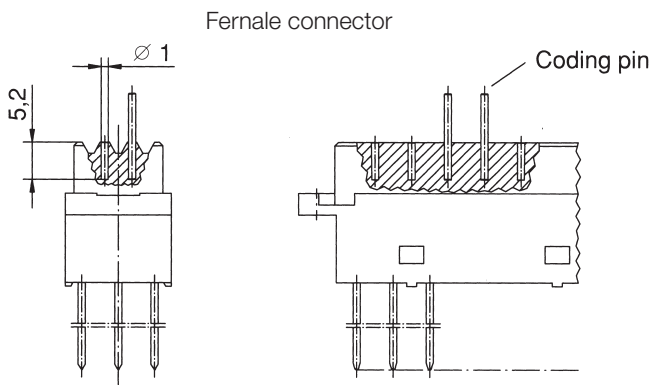

Suitable for Type D,E,F

Part number: **033007**

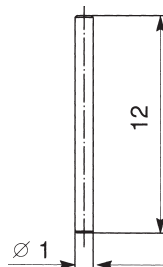

Male connector

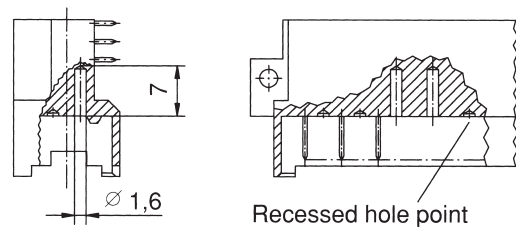

Suitable for Type H15,H7/F24

Part number: **424338**

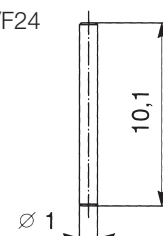

Coding Tool

For inserting coding pins into the predrilled holes on the female connector.

Part number: **063007**



DIN 41612 / IEC 60603-2 Connectors Applications

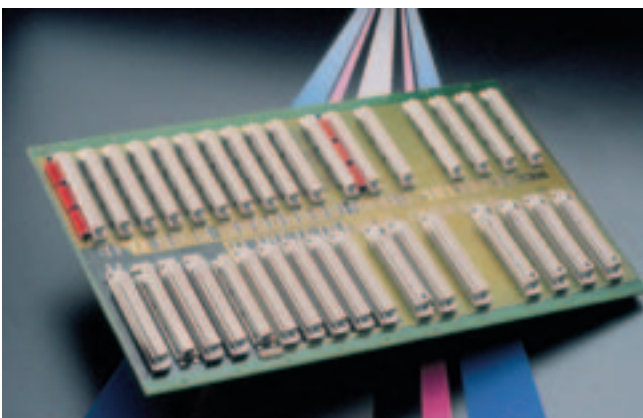
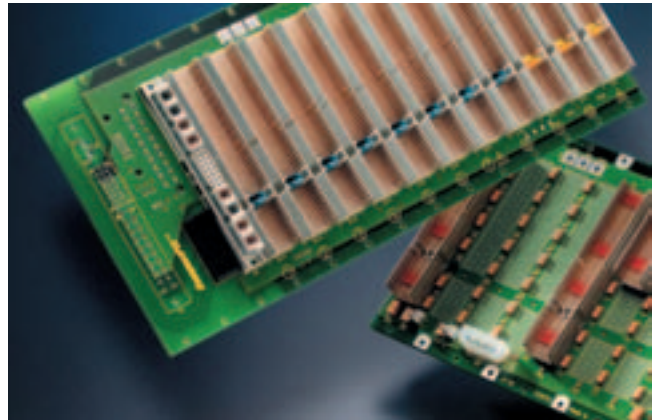

DIN 41612 / IEC 60603-2 Connectors Applications

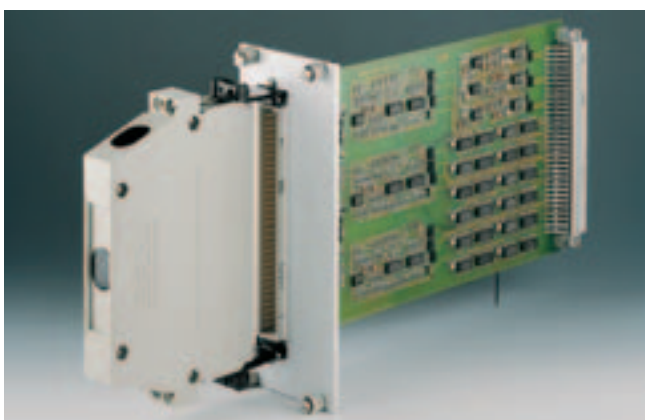
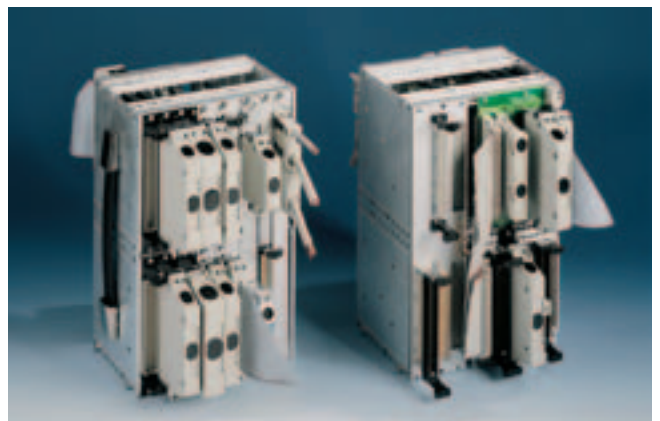
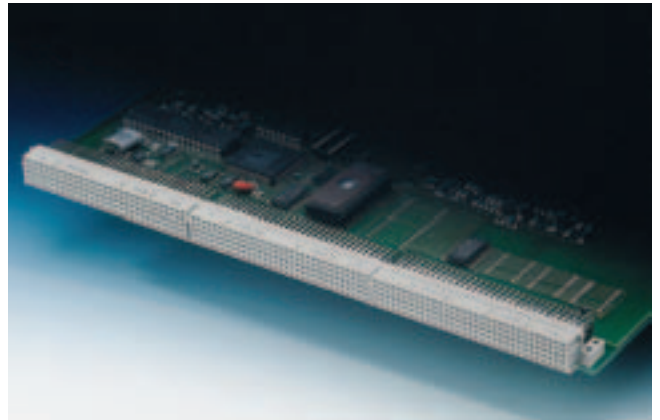
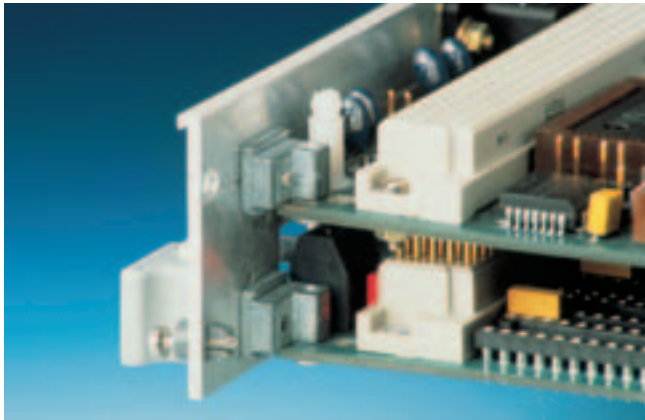



Part Number	Page	Part Number	Page
003382	142	013275	191
004177	141	013414	138
004289	128	013653	142
004362	62	013970	148
004413	54	014145	191
004427	134	014374	189
004483	45	014375	189
004484	88	023545	23
004485	88	023783	53
004498	45	023816	104
004500	91	024069	186
004777	116	024070	187
004778	116	024104	186
013025	134	024201	152
013026	141	033007	197
013058	116	033014	196
013071	122	033055	184
013073	122	033298	104
013074	122	033427	134
013096	116	033428	135
013130	23	033436	104
013131	52	033579	135
013132	52	033704	116
013133	30	034190	163
013134	62	034702	191
013135	27	034796	191
013136	58	034797	191
013154	110	034798	191
013155	122	034799	191
013156	113	034800	191
013157	125	034801	191
013160	122	034802	191
013161	122	043064	141
013164	122	043582	58
013166	125	043606	23
013167	125	044639	163
013171	110	053395	162
013172	110	053400	162
013174	110	053408	162
013175	110	053410	162
013178	110	053412	162
013183	113	054755	149
013184	113	054756	148
013254	52	063007	197



Part Number	Page	Part Number	Page
063046	142	154954	59
063048	142	154956	62
063049	142	154957	62
063277	88	154959	104
063300	138	154961	85
063357	149	154964	88
063358	148	154970	110
063465	141	154971	113
063515	55	164306	85
063795	52	164944	55
064312	162	194576	85
064583	191	194578	85
064584	191	204752	68
064585	191	214836	72
064586	191	220051	12
064708	191	220051	11
064709	191	220051	11
064710	191	220108	12
064711	191	220108	11
064712	191	220139	11
064713	191	220153	11
064714	191	220316	12
064715	191	220364	12
064716	191	220368	11
064717	191	220369	11
064728	191	220370	12
064729	191	220411	12
064755	162	220527	12
064757	162	220527	11
083502	195	220527	11
083504	195	220681	12
083506	195	220889	11
104552	52	220890	11
123211	162	220891	11
123589	62	220892	11
123601	59	220894	11
123717	58	220991	12
123751	53	223346	55
123905	182	223368	73
134581	55	223839	71
144705	55	224408	68
144708	91	224410	67
144710	88	224411	71
144713	104	224412	68



Part Number	Page	Part Number	Page
224470	72	244672	119
224471	71	244999	107
224473	73	254015	68
224474	73	254062	157
224475	73	254117	68
224476	73	254118	107
230032	12	254120	67
233226	168	254121	68
233230	168	254124	119
233232	168	254135	66
233233	168	254136	66
233234	168	254137	67
233235	168	254141	83
234062	188	254320	80
234063	188	254321	80
234064	188	254326	101
234065	188	254370	41
234066	188	254498	77
234067	188	254836	80
234069	66	254838	80
234432	70	254843	107
234516	68	254844	107
234647	76	254846	33
234712	83	254847	33
234713	83	254848	33
243246	169	254851	67
244126	67	254852	76
244139	95	254854	76
244265	69	254878	33
244268	67	254887	76
244294	67	254893	76
244295	68	254895	77
244296	69	254896	76
244297	69	254897	72
244298	69	254931	72
244299	69	254960	119
244300	70	254970	77
244301	71	254975	119
244302	71	254976	33
244303	71	254977	107
244304	72	254978	107
244305	72	254979	107
244306	72	254995	80
244307	72	284035	77



Part Number	Page	Part Number	Page
284082	70	284419	101
284134	68	284420	83
284135	68	284650	35
284136	76	284651	34
284164	34	284652	69
284165	35	284653	95
284166	35	284752	68
284167	38	284870	34
284168	38	284871	34
284169	41	284873	34
284170	71	284874	34
284171	76	284875	34
284172	77	284876	35
284173	80	284877	35
284174	77	284878	35
284175	77	284880	35
284176	80	284881	35
284177	33	284882	35
284178	33	284883	35
284179	33	284886	38
284180	107	284888	38
284181	107	284889	38
284182	107	284891	38
284183	107	284895	38
284184	119	284896	41
284185	119	284933	76
284258	94	284938	77
284259	94	284941	77
284260	94	284942	77
284261	94	284944	77
284262	94	284951	107
284263	94	284968	69
284264	94	284970	69
284269	95	284971	66
284270	95	284975	70
284272	88	284976	71
284308	72	284977	71
284313	119	284979	71
284318	80	284984	72
284319	38	284991	72
284323	76	294694	34
284324	98	294710	157
284325	98	294711	158
284418	41	294712	158



Part Number	Page	Part Number	Page
294716	101	354111	160
294721	49	354112	159
294722	49	354116	156
294728	157	354117	160
294730	160	354133	160
294732	156	354134	98
294733	157	354135	94
294736	156	354139	157
294737	157	354140	157
294738	76	354152	158
294740	156	354155	160
294742	67	354156	160
294743	156	354157	158
294863	101	354158	160
294927	49	354159	98
303284	144	354160	159
303484	144	354161	159
304221	84	354162	158
304225	84	354163	158
304421	84	354164	159
304425	84	354165	160
314404	149	354166	158
314425	149	354173	159
314447	149	354215	159
333139	191	354219	158
333139	183	354220	98
334203	144	354223	158
334210	84	354226	159
334211	84	354229	159
334214	84	354239	158
334215	84	354240	159
334403	144	354246	156
334410	84	354247	156
334411	84	354251	98
334414	84	354252	156
334415	84	354381	83
344234	150	354382	88
344265	150	354383	91
344434	150	354384	88
344451	150	354385	83
344465	150	354388	91
354108	159	354395	83
354109	160	354396	83
354110	160	354397	88



Part Number	Page	Part Number	Page
354399	83	414416	54
354400	83	414574	174
354406	88	414575	173
354418	83	414702	83
354972	128	414705	195
364104	49	414715	191
364366	156	414715	183
374849	156	424188	62
413168	174	424189	62
413169	173	424195	91
413170	175	424201	88
413171	179	424207	30
413172	179	424213	45
413173	180	424219	45
413637	174	424338	197
413638	173	424623	184
413640	179	424654	169
413852	27	424655	169
413853	27	424797	134
413858	58	424798	134
413859	58	424801	134
413864	59	424803	134
413865	59	424804	134
413971	191	424806	141
413971	183	424807	141
414068	184	424810	141
414082	184	424812	141
414219	191	424813	141
414219	183	433215	191
414327	76	433222	164
414377	24	433590	128
414378	24	433591	128
414379	24	434286	191
414380	24	434286	183
414401	53	434325	54
414403	53	434329	59
414404	53	434878	196
414406	54	471555	189
414407	54	471556	12
414409	54	471556	12
414410	54	471556	12
414412	54	471556	12
414413	54	471556	12
414415	54	471584	11



Part Number	Page	Part Number	Page
471584	11	471867	11
471590	11	471920	11
471591	11	471922	12
471592	11	471943	11
471597	12	473161	11
471606	12	473188	184
471608	12	473200	184
471628	12	473270	196
471629	12	473447	12
471630	12	473447	12
471631	12	473447	11
471632	12	473447	11
471633	12	473447	11
471634	12	473447	11
471637	12	473449	11
471638	12	533201	54
471640	12	533202	54
471677	11	533203	53
471684	11	533206	23
471684	11	533207	23
471684	11	533208	23
471694	11	533210	131
471694	11	533401	54
471694	11	533402	54
471710	12	533403	53
471710	12	533404	53
471729	12	533406	23
471729	12	533407	23
471729	12	533408	23
471729	12	533410	131
471787	11	533423	53
471791	11	593248	179
471793	12	593250	179
471793	12	593252	179
471836	11	593254	179
471837	11	593256	180
471839	11	593808	153
471855	12	593809	153
471855	11	593811	153
471855	11	593812	153
471867	11	593814	152
471867	11	593815	152
471867	11	593817	152
471867	11	593818	152



Part Number	Page	Part Number	Page
593927	45	594566	135
593928	45	594567	135
593933	45	594569	135
593934	45	594570	135
593952	45	594575	142
593964	45	594576	142
593990	148	594578	142
593991	148	594579	142
594056	27	594613	27
594096	131	594614	27
594157	153	594633	58
594159	153	594634	58
594160	153	594635	58
594162	152	594636	58
594163	152	594638	59
594165	152	594640	59
594166	152	594641	59
594168	163	594750	175
594170	163	594751	175
594172	163	594752	175
594174	163	594802	138
594176	163	913049	184
594178	163	913615	116
594180	163	913637	163
594182	163	913716	163
594184	164	913738	169
594207	162	913767	104
594209	162	914004	164
594211	162	354197	156
594213	162		
594215	162		
594219	164		
594220	164		
594221	163		
594223	163		
594225	163		
594227	163		
594229	163		
594231	163		
594233	164		
594343	138		
594400	59		
594470	182		
594491	148		



Member



VMEbus INTERNATIONAL TRADE ASSOCIATION





ERNI Electronics GmbH & Co. KG

Seestrasse 9
73099 Adelberg/Germany
Tel +49 71 66 50-0
Fax +49 71 66 50-282
info@erni.de

Europe South America Africa Japan

ERNI Electronics, Inc.

2201 Westwood Ave
Richmond, VA 23230/USA
Tel +1 804 228-4100
Fax +1 804 228-4099
info.usa@erni.com

North America Canada Mexico

ERNI Asia Holding Pte Ltd.

Blk 4008 Ang Mo Kio Avenue 10
#04-01/02 Techplace I
Singapore 569625
Tel +65 6 555 5885
Fax +65 6 555 5995
info@erni-asia.com

Asia Australia New Zealand

www.erni.com

© ERNI Electronics GmbH & Co. KG 2009 • Printed in Germany. A policy of continuous improvement is followed and the right to alter any published data without notice is reserved. ERNI[®], MicroStac[®], MicroSpeed[®], MiniBridge[®], MaxiBridge[®], ERmet[®], ERmet ZD[®], ERbic[®] and ERNIPRESS[®] are trademarks (registered or applied for in various countries) of ERNI Electronics GmbH & Co. KG.