

SUMMARY



Image is for illustrative purpose only

Wires

Low	8
High	0
Coax	0
Triax	0
Quad	0
Fiber	0
Fluidic	0

Series	1B
Termination type	Female print PCB
IP rating	50
Cable Ø	0.00 - 0.00 mm
Matching parts	
Status	active
Alternative part	

Download

- [Request a quote](#)
- [PCB Eagle Pattern](#)
- [PCB Altium Pattern](#)
- [Catalog](#)

TECHNICAL DETAILS

Mechanics

Shell Style/Model	EX*: Elbow receptacle for printed circuit with two nuts (solder or screw fixing, back panel mounting)
Keying	1 key (alpha=0, plug: male contacts, receptacle: female contacts)
Housing Material	PPS (Polyphenylene) shell, other pieces nickel plated brass
Cable Fixing	∅ 0 - 0 mm
Variant	

Performance

Configuration	1B.308/EXG : 8 Low Voltage
Insulator	L: PEEK (UL 94 / V-0/3.2, depends on material thickness)
Rated Current	

Specifications

Contact Type: Print (straight)
Max. Matings: 5000

LEMO products and services are provided "as is". LEMO makes no warranties or representations with regard to LEMO product & services or use of them, express, implied or statutory, including for accuracy, completeness, or security. The user is fully responsible for his products and applications using LEMO components.

Contact Dia.: 0.7 mm (0.028in)
 R (max): 6.1 mOhm
 Vtest (contact-shell): 1150 V (AC), 1630 V (DC)
 Vtest (contact-contact): 950 V (AC), 1340 V (DC)

Others

Temp (min / max): -55° C / +250° C
 Humidity (max): <=95% [at 60 deg C /140 F]
 Vibration: 15 g [10 Hz - 2000 Hz]
 Shock Resistance: 100 g [6 ms]
 Salt Spray Corrosion: >1000 hr
 Climatical Category: 50/175/21
 Shielding (min): 75 dB (10 MHz)
 Shielding (min): 40 dB (1 GHz)
 IP Rating: 50

DRAWINGS

Draws

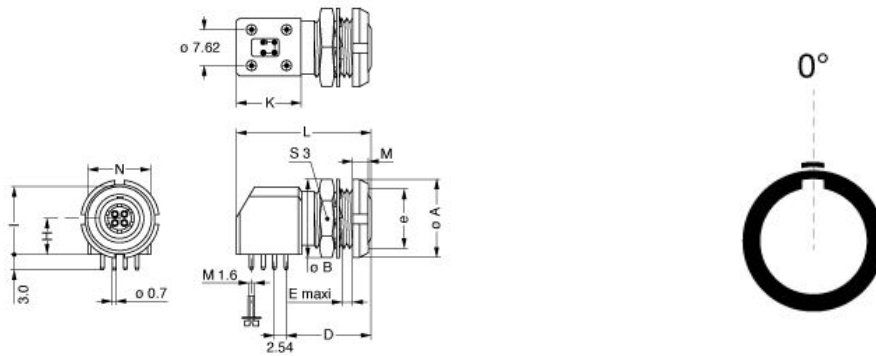

Dimensions

	A	B	D	E	H	I	K	L	M	N	S3	e
mm.	14	15	16.5	7.5	7.7	14	13.2	27	3.5	14	13	M11x0.5
in.	0,55	0,59	0,65	0,30	0,30	0,55	0,52	1,06	0,14	0,55	0,51	

RECOMMENDED BY LEMO

Tools

LEMO products and services are provided "as is". LEMO makes no warranties or representations with regard to LEMO product & services or use of them, express, implied or statutory, including for accuracy, completeness, or security. The user is fully responsible for his products and applications using LEMO components.

None

Cables

LEMO products and services are provided "as is". LEMO makes no warranties or representations with regard to LEMO product & services or use of them, express, implied or statutory, including for accuracy, completeness, or security. The user is fully responsible for his products and applications using LEMO components.