

**PLEASE CHECK WWW.MOLEX.COM FOR LATEST PART INFORMATION**

**Part Number:** **0521031619**  
**Status:** **Active**  
**Description:** 1.00mm (.039") Pitch FFC/FPC Connector, SMT, Right Angle, ZIF, Top Contact Style Receptacle, Tray Packaging, 16 Circuits, Lead-Free

**Documents:**

[3D Model](#) [Product Specification PS-52103-004 \(PDF\)](#)  
[Drawing \(PDF\)](#) [RoHS Certificate of Compliance \(PDF\)](#)

**Agency Certification**

CSA LR19980  
 UL E29179

**General**

Product Family FFC/FPC Connectors  
 Series 52103  
 Product Name N/A

**Physical**

Circuits (Loaded) 16  
 Color - Resin Natural  
 Contact Position Top  
 Durability (mating cycles max) 30  
 Entry Angle 90° Angle  
 Flammability 94V-0  
 Mated Height 2.70mm (.106")  
 Material - Metal Phosphor Bronze  
 Material - Plating Mating Tin-Bismuth  
 Material - Plating Termination Tin-Bismuth  
 Material - Resin High Temperature Thermoplastic  
 Number of Rows 1  
 Orientation Right Angle  
 PC Tail Length 2.00mm (.079")  
 PCB Locator Yes  
 PCB Retention Yes  
 Packaging Type Tray  
 Pitch - Mating Interface 1.00mm (.039")  
 Plating min - Mating 1.016µm (40µ")  
 Plating min - Termination 1.016µm (40µ")  
 Polarized to PCB No  
 Stackable No  
 Surface Mount Compatible (SMC) N/A  
 Temperature Range - Operating -20°C to +85°C  
 Termination Interface: Style Surface Mount  
 Wire/Cable Type FFC/FPC

**Electrical**

Current - Maximum per Contact 1A  
 Voltage - Maximum 125V

**Material Info**

**Reference - Drawing Numbers**

Product Specification PS-52103-004  
 Sales Drawing SD-52103-002

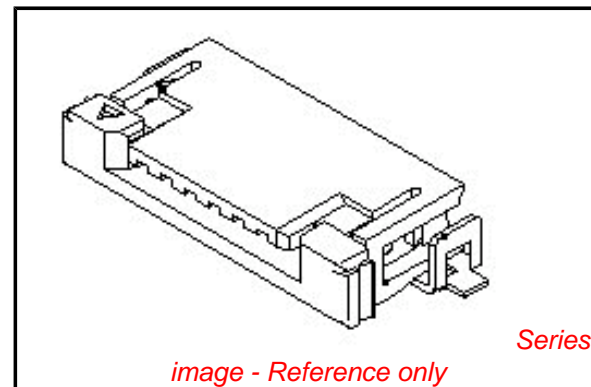

*image - Reference only*

**EU RoHS**

**ELV and RoHS Compliant**  
**REACH SVHC Contains SVHC: No**  
**Low-Halogen Status Not Reviewed**

**China RoHS**



**Need more information on product environmental compliance?**

Email [productcompliance@molex.com](mailto:productcompliance@molex.com)  
 For a multiple part number RoHS Certificate of Compliance, [click here](#)

Please visit the [Contact Us](#) section for any non-product compliance questions.

**Search Parts in this Series**

[52103Series](#)

This document was generated on 06/30/2011

**PLEASE CHECK [WWW.MOLEX.COM](http://WWW.MOLEX.COM) FOR LATEST PART INFORMATION**