

8 7 6 5 4 3 2 1

THE INFORMATION CONTAINED IN THIS DRAWING IS THE SOLE PROPERTY OF ANDERSON POWER PRODUCTS. ANY REPRODUCTION IN PART OR WHOLE WITHOUT THE WRITTEN PERMISSION OF ANDERSON POWER PRODUCTS IS PROHIBITED.

**Copyright 2013**

ANDERSON POWER PRODUCTS RESERVES THE RIGHT TO ALTER PRODUCT TYPES, THEIR TECHNICAL DATA, DIMENSION, STYLE AND ACCESSORIES WITHOUT PRIOR NOTIFICATION.

COMPONENTS INCLUDED		
ITEM	QTY	DESCRIPTION
1	1	STRAIGHT PLUG SHELL (FEMALE) WITH O-RING

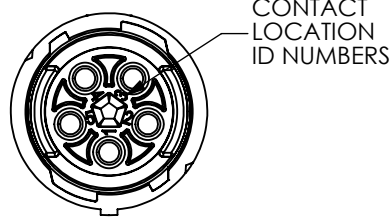
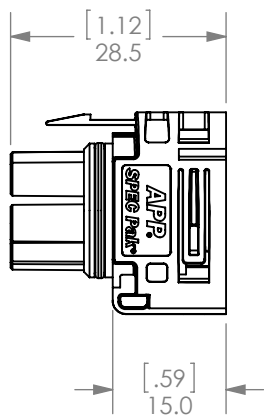
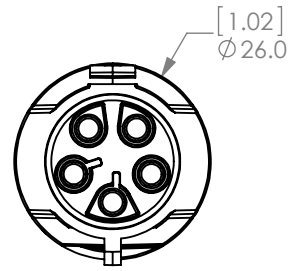
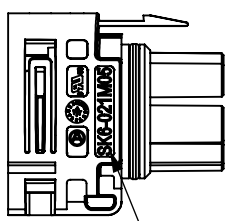
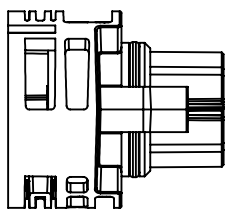
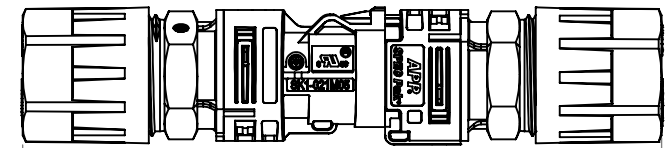
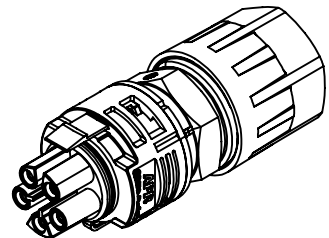
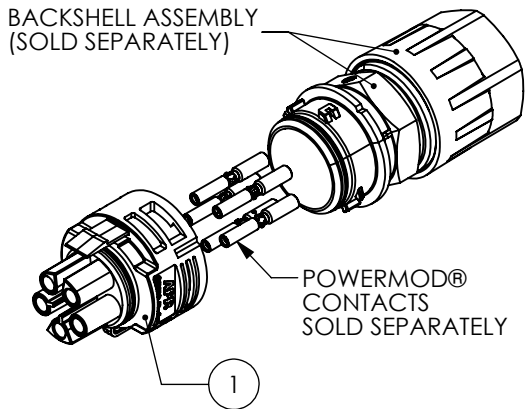

**PART NO: SK6-021M05**  
SEE SHEET 2 FOR ADDITIONAL KEYS

- NOTES:
- MATERIAL
    - A. PLUG SHELL - PC, BLACK
    - B. O-RING - NBR, BLACK
  - FOR USE WITH POWERMOD® SOCKET CONTACTS (SOLD SEPARATELY)
  - REFER TO ASSEMBLY INSTRUCTIONS 1S6616

DIMENSIONS ARE IN:	MM [INCH]	<b>APPROVALS</b>			<b>ANDERSON POWER PRODUCTS</b>		
UNLESS OTHERWISE STATED		DRAWN	10/7/2013		TITLE		
TOLERANCES:		CHECKED	1/23/2014	5-POSITION MINI-PL SPEC PAK® STRAIGHT PLUG SHELL (FEMALE)			
DECIMALS (INCH)	DECIMALS (MM)	ANGLES		MFG APPRV	1/24/2014		
.XX ± .02	.X ± .5	±2°		CHB			
SURFACE FINISH:				QC APPRV	1/20/2014		
MACHINED	3.2µ [128µin]			UFN			
MOLDED	1.6µ [64µin]			ENG APPRV	1/23/2014	SIZE	DWG NO.
MATERIAL: SEE NOTE 1				CMS		A	115306S1
FINISH:						SCALE	CADFILE
						NONE	04070
							SHEET
							1 OF 2

1	ECRN-15568	TWE	2/6/2014
REV.	DESCRIPTION	APPRV	DATE
REVISIONS			

8 7 6 5 4 3 2 1

8                      7                      6                      5                      4                      3                      2                      1

THE INFORMATION CONTAINED IN THIS DRAWING IS THE SOLE PROPERTY OF ANDERSON POWER PRODUCTS. ANY REPRODUCTION IN PART OR WHOLE WITHOUT THE WRITTEN PERMISSION OF ANDERSON POWER PRODUCTS IS PROHIBITED.

**Copyright 2013**

ANDERSON POWER PRODUCTS RESERVES THE RIGHT TO ALTER PRODUCT TYPES, THEIR TECHNICAL DATA, DIMENSION, STYLE AND ACCESSORIES WITHOUT PRIOR NOTIFICATION.

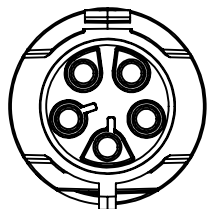

SK6-021M05

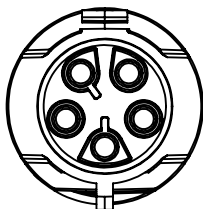

SK6-A21M05

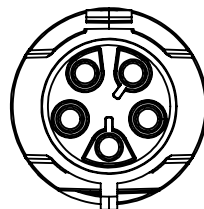

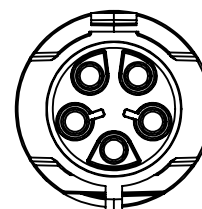

SK6-B21M05



SK6-F21M05

NOTE:  
CONTACT FACTORY FOR  
ADDITIONAL KEYS

DIMENSIONS ARE IN:		MM [INCH]	<b>APPROVALS</b>		 <b>ANDERSON POWER PRODUCTS</b> <b>TITLE</b> 5-POSITION MINI-PL SPEC PAK® STRAIGHT PLUG SHELL (FEMALE)
UNLESS OTHERWISE STATED			<b>DRAWN</b>	NTS 10/7/2013	
TOLERANCES:			<b>CHECKED</b>	MM 1/23/2014	
DECIMALS (INCH)	DECIMALS (MM)	ANGLES	<b>MFG APPRV</b>	CHB 1/24/2014	
.XX ± .02	.X ± .5	±2°	<b>QC APPRV</b>	UFN 1/20/2014	
SURFACE FINISH:			<b>ENG APPRV</b>	CMS 1/23/2014	
MACHINED 3.2µ [128µin] ✓			<b>SIZE</b>	A	
MOLDED 1.6µ [64µin] ✓			<b>DWG NO.</b>	115306S1	
MATERIAL: SEE NOTE 1			<b>REV.</b>	1	
FINISH:			<b>SCALE</b>	NONE	
			<b>CADFILE</b>	04070	
-CAD GENERATED DRAWING- DO NOT MANUALLY UPDATE DO NOT SCALE			<b>SHEET</b>	2 OF 2	

REV.	DESCRIPTION	APPRV	DATE
-	See Sheet1	-	-
REVISIONS			

8                      7                      6                      5                      4                      3                      2                      1