



■ Features :

- 1U low profile 41mm
- High power density 10.7w/inch³
- 2000VAC I/O Isolation
- Protections: Short circuit / Overload / Over voltage / Over temperature
- Output OK signal
- Built-in remote ON-OFF control
- Built-in remote sense function
- Forced air cooling by built-in DC fan with fan speed control
- 12V, 0.25A auxiliary output
- 3 years warranty

CB CE

SPECIFICATION

MODEL		SD-1000L-12	SD-1000L-24	SD-1000L-48	SD-1000H-12	SD-1000H-24	SD-1000H-48
OUTPUT	DC VOLTAGE	12V	24V	48V	12V	24V	48V
	RATED CURRENT	60A	40A	21A	60A	40A	21A
	CURRENT RANGE	0 ~ 60A	0 ~ 40A	0 ~ 21A	0 ~ 60A	0 ~ 40A	0 ~ 21A
	RATED POWER	720W	960W	1008W	720W	960W	1008W
	RIPPLE & NOISE (max.) Note.2	150mVp-p	150mVp-p	150mVp-p	150mVp-p	150mVp-p	150mVp-p
	VOLTAGE ADJ. RANGE	11 ~ 15V	23 ~ 30V	46 ~ 60V	11 ~ 15V	23 ~ 30V	46 ~ 60V
	VOLTAGE TOLERANCE Note.3	±1.0%	±1.0%	±1.0%	±1.0%	±1.0%	±1.0%
	LINE REGULATION	±0.5%	±0.5%	±0.5%	±0.5%	±0.5%	±0.5%
	LOAD REGULATION	±0.5%	±0.5%	±0.5%	±0.5%	±0.5%	±0.5%
SETUP, RISE TIME		500ms, 50ms at full load					
INPUT	VOLTAGE RANGE Note.5	19 ~ 72VDC			72 ~ 144VDC		
	EFFICIENCY (Typ.)	84%	88%	90%	85%	89%	92%
	DC CURRENT (Typ.)	23.5A/48VDC			11.6A/96VDC		
	INRUSH CURRENT (Typ.)	-----			100A/96VDC		
PROTECTION	OVERLOAD	105 ~ 125% rated output power Protection type : Constant current limiting, unit will shut down o/p voltage after about 5sec. Re-power on to recover					
	OVER VOLTAGE	16 ~ 19V	30.8 ~ 35.2V	62 ~ 68V	16 ~ 19V	30.8 ~ 35.2V	62 ~ 68V
	OVER TEMPERATURE	Shut down o/p voltage, recovers automatically after temperature goes down Protection type : Shut down o/p voltage, re-power on to recover					
FUNCTION	REMOTE ON/OFF CONTROL	Please refer to function manual					
	OUTPUT OK SIGNAL	Open collector signal low when PSU turns on, maximum, sink current :10mA					
ENVIRONMENT	WORKING TEMP.	-20 ~ +60°C (Refer to "Derating Curve")					
	WORKING HUMIDITY	20 ~ 90% RH non-condensing					
	STORAGE TEMP., HUMIDITY	-40 ~ +85°C, 10 ~ 95% RH					
	TEMP. COEFFICIENT	±0.02%/°C (0 ~ 50°C)					
	VIBRATION	10 ~ 500Hz, 2G 10min./1cycle, 60min. each along X, Y, Z axes					
SAFETY & EMC (Note 4)	SAFETY STANDARDS	IEC60950-1 CB approved by TUV					
	WITHSTAND VOLTAGE	I/P-O/P:2KVAC I/P-FG:2KVAC O/P-FG:0.5KVAC					
	ISOLATION RESISTANCE	I/P-O/P, I/P-FG, O/P-FG:100M Ohms / 500VDC / 25°C / 70% RH					
	EMC EMISSION	Compliance to EN55022 (CISPR22)					
OTHERS	EMC IMMUNITY	Compliance to EN61000-4-2,3,4,6,8, light industry level, criteria A					
	MTBF	106.7K hrs min. MIL-HDBK-217F (25°C)					
	DIMENSION	295*127*41mm (L*W*H)					
NOTE	PACKING	1.94Kg; 6pcs/12.6Kg/1.15CUFT					
	1. All parameters NOT specially mentioned are measured at 48, 96VDC input, rated load and 25°C of ambient temperature. 2. Ripple & noise are measured at 20MHz of bandwidth by using a 12" twisted pair-wire terminated with a 0.1uf & 47uf parallel capacitor. 3. Tolerance : includes set up tolerance, line regulation and load regulation. 4. The power supply is considered a component which will be installed into a final equipment. All the EMC tests are been executed by mounting the unit on a 720mm*360mm metal plate with 1mm of thickness. The final equipment must be re-confirmed that it still meets EMC directives. For guidance on how to perform these EMC tests, please refer to "EMI testing of component power supplies." (as available on http://www.meanwell.com) 5. Derating may be needed under low input voltages. Please check the derating curve for more details.						

File Name:SD-1000-SPEC 2015-07-27

Specifications are subject to change without notice. It is responsibility of each customer to thoroughly test each product and part number under their unique parameters and environments to ensure a product will work properly and reliably.

Click below for more details, to buy on-line or request volume pricing:
<http://power.sager.com/mean-well-SD-1000-dc-dc-converter.html>

(866) 588-1750
 power@sager.com
<http://power.sager.com>

Mechanical Specification

Case No. 952B Unit:mm

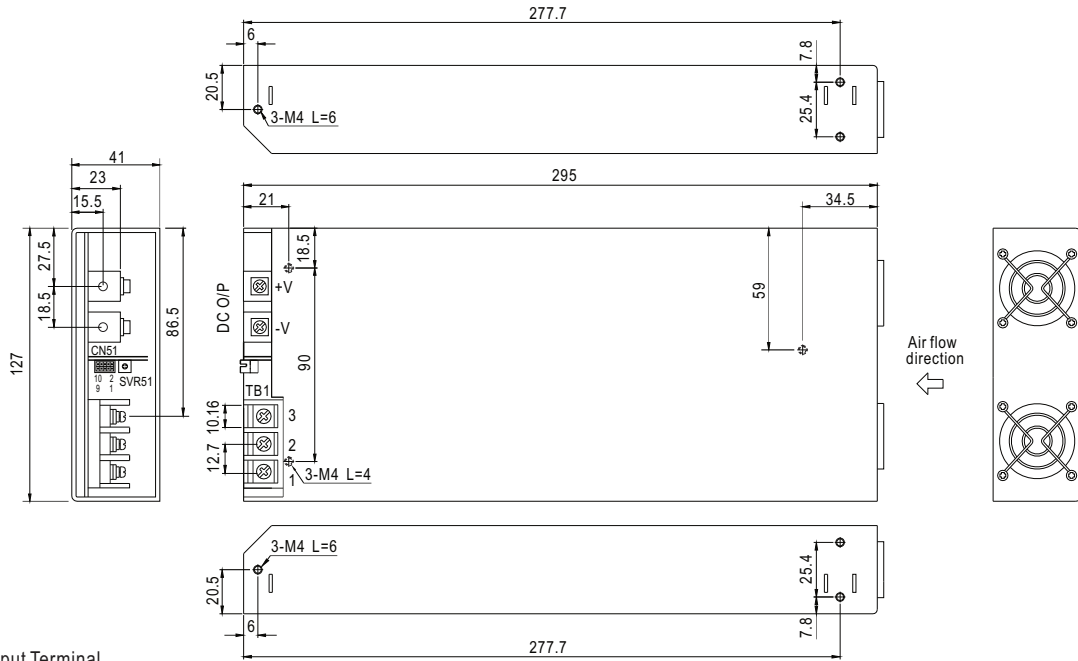

DC Input Terminal
 Pin No. Assignment

Pin No.	Assignment
1	DC INPUT V+
2	DC INPUT V-
3	FG \perp

Control pin number assignment (CN51) : HRS DF11-10DP-2DS or equivalent

Pin No.	Assignment	Pin No.	Assignment	Pin No.	Assignment	Mating Housing	Terminal
1	+S	5	AUX	9	RCG	HRS DF11-10DS or equivalent	JST SPHD-002T-P0.5 or equivalent
2	-S	6	AUXG	10	NC		
3	OUTPUT OK	7	RC1				
4	GND	8	RC2				

Block Diagram

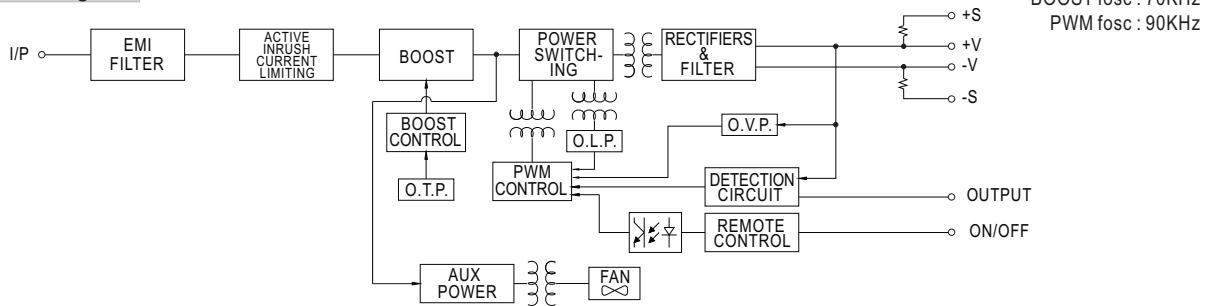

BOOST fosc : 70KHz
 PWM fosc : 90KHz

Derating Curve

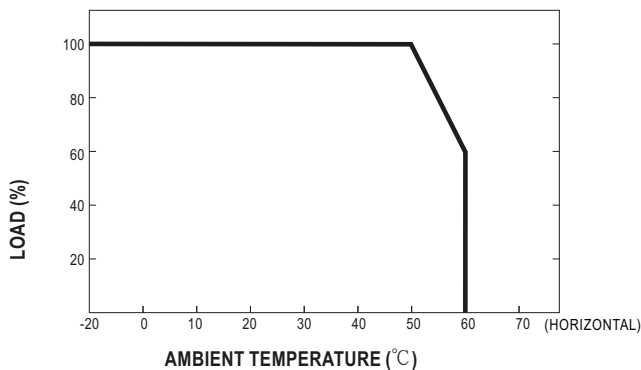

Static Characteristics

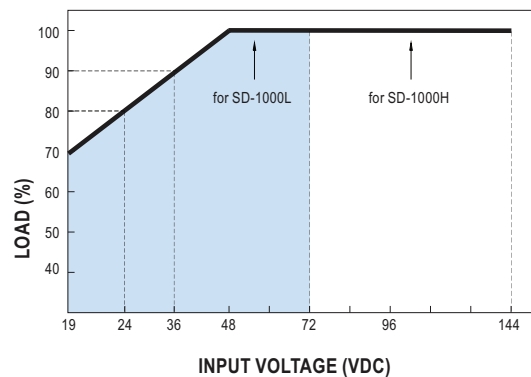

Specifications are subject to change without notice. It is responsibility of each customer to thoroughly test each product and part number under their unique parameters and environments to ensure a product will work properly and reliably.

Function Description of CN51

Pin No.	Function	Description
1	+S	Positive sensing. The +S signal should be connected to the positive terminal of the load. The +S and -S leads should be twisted in pair to minimize noise pick-up effect. The maximum line drop compensation is 0.5V.
2	-S	Negative sensing. The -S signal should be connected to the negative terminal of the load. The -S and +S leads should be twisted in pair to minimize noise pick-up effect. The maximum line drop compensation is 0.5V.
3	O/P OK	Open collector signal, referenced to pin4(GND). Low when PSU turns on. The maximum sink current is 10mA and the maximum external voltage is 13V.
4	GND	These pins connect to the negative terminal (-V).
5	AUX	Auxiliary voltage output, 10.8~13.2V referenced to pin6(AUXG).The maximum load current is 0.25A.
6	AUXG	Auxiliary voltage output ground. The signal return is isolated from the output terminals(+V & -V).
7	RC1	Remote ON/OFF
8	RC2	Remote ON/OFF
9	RCG	Remote ON/OFF ground
10	NC	No connection

Function Manual

1.Remote ON/OFF

- (1) Remote ON/OFF control becomes available by applying voltage in CN51
- (2) Table 1.1 shows the specification of Remote ON/OFF function
- (3) Fig. 1.2 shows the example to connect Remote ON/OFF control function

Table 1.1 Specification of Remote ON/OFF

Connection Method		Fig. 1.2(A)	Fig. 1.2(B)	Fig. 1.2(C)
SW Logic	Output on	SW Open	SW Open	SW Close
	Output off	SW Close	SW Close	SW Open

Fig. 1.2 Examples of connecting remote ON/OFF

(A) Using external voltage source

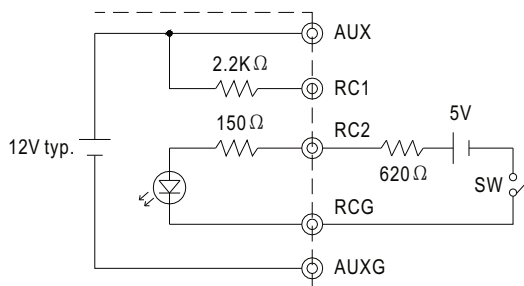

(B) Using internal 12V auxiliary output

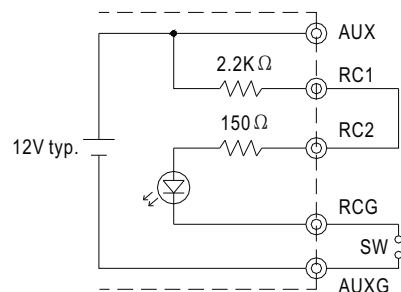

(C) Using internal 12V auxiliary output

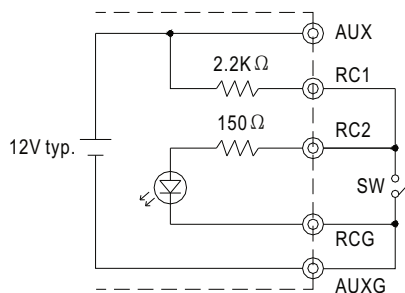

2. Output OK signal

"Output OK" is an open collector signal. It indicates the output status of the PSU. It can operate in two ways : One is sinking current from external signal ; the other is sending out a voltage signal.

2-1 Sink current :

The maximum sink current is 10mA and the maximum external voltage is 13V.

2-2 Voltage signal :

Between O/P OK(pin3) and GND(pin4)	Output Status
0 ~ 0.5V	ON
12 ~ 13V	OFF

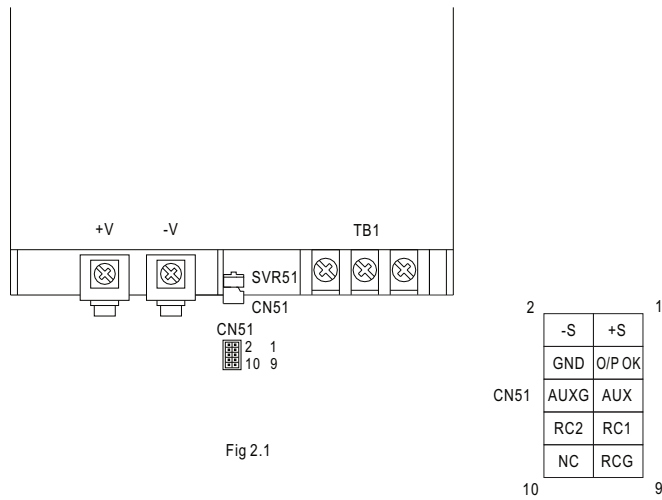

Fig 2.1

3. Remote Sense

The remote sensing compensates voltage drop on the load wiring up to 0.5V.

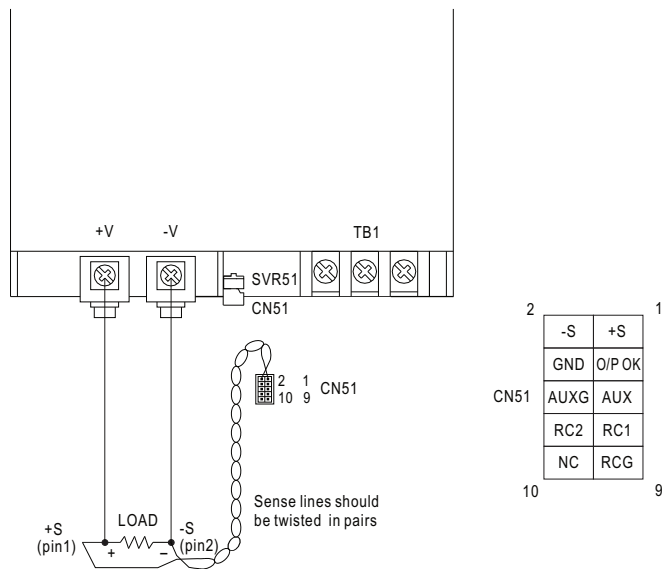

Fig 3.1