

160W Convection
240W with 18 CFM
300W Peak



- ITE & Medical Safety Approvals
- 2 MOPP Medical Safety Approvals
- Appropriate for BF application
- Built-in active PFC
- 160 Watts with convection
- 240 Watts with forced air
- 300 Watt for motor start up
- I/P <0.5W when O/P <50mW
- With 12V/0.5A output for fan
- Open Frame / U-Frame / Enclosed
- 10 Year Warranty



MODEL	VOUT	MIN LOAD	CONV MAX LOAD	18CFM MAX LOAD	PEAK LOAD
ITE OPEN-FRAME MODELS					
SNP-G167-A	12V	0	13.3A	20.00A	26.60A
SNP-G168-A	15V	0	10.66A	16.00A	21.30A
SNP-G165-A	18V	0	8.88A	13.33A	17.80A
SNP-G169-A	24V	0	6.66A	10.00A	13.30A
SNP-G16G-A	28V	0	5.70A	8.55A	11.40A
SNP-G16J-A	36V	0	4.45A	6.66A	8.90A
SNP-G16T-A	48V	0	3.35A	5.00A	6.67A
ITE U-FRAME MODELS					
SNP-G167-UA	12V	0	13.3A	20.00A	26.60A
SNP-G168-UA	15V	0	10.66A	16.00A	21.30A
SNP-G165-UA	18V	0	8.88A	13.33A	17.80A
SNP-G169-UA	24V	0	6.66A	10.00A	13.30A
SNP-G16G-UA	28V	0	5.70A	8.55A	11.40A
SNP-G16J-UA	36V	0	4.45A	6.66A	8.90A
SNP-G16T-UA	48V	0	3.35A	5.00A	6.67A
ITE COVERED MODELS					
SNP-G167-CA	12V	0	13.3A	20.00A	26.60A
SNP-G168-CA	15V	0	10.66A	16.00A	21.30A
SNP-G165-CA	18V	0	8.88A	13.33A	17.80A
SNP-G169-CA	24V	0	6.66A	10.00A	13.30A
SNP-G16G-CA	28V	0	5.70A	8.55A	11.40A
SNP-G16J-CA	36V	0	4.45A	6.66A	8.90A
SNP-G16T-CA	48V	0	3.35A	5.00A	6.67A

MODEL	VOUT	MIN LOAD	CONV MAX LOAD	18CFM MAX LOAD	PEAK LOAD
MEDICAL OPEN FRAME MODELS					
SNP-G167-MA	12V	0	13.3A	20.00A	26.60A
SNP-G168-MA	15V	0	10.66A	16.00A	21.30A
SNP-G165-M	18V	0	8.88A	13.33A	17.80A
SNP-G169-MA	24V	0	6.66A	10.00A	13.30A
SNP-G16G-MA	28V	0	5.70A	8.55A	11.40A
SNP-G16J-MA	36V	0	4.45A	6.66A	8.90A
SNP-G16T-MA	48V	0	3.35A	5.00A	6.67A
MEDICAL U-FRAME MODELS					
SNP-G167-U5	12V	0	13.3A	20.00A	26.60A
SNP-G168-U5	15V	0	10.66A	16.00A	21.30A
SNP-G165-U5	18V	0	8.88A	13.33A	17.80A
SNP-G169-U5	24V	0	6.66A	10.00A	13.30A
SNP-G16G-U5	28V	0	5.70A	8.55A	11.40A
SNP-G16J-U5	36V	0	4.45A	6.66A	8.90A
SNP-G16T-U5	48V	0	3.35A	5.00A	6.67A
MEDICAL ENCLOSED MODELS					
SNP-G167-C5	12V	0	13.3A	20.00A	26.60A
SNP-G168-C5	15V	0	10.66A	16.00A	21.30A
SNP-G165-C5	18V	0	8.88A	13.33A	17.80A
SNP-G169-C5	24V	0	6.66A	10.00A	13.30A
SNP-G16G-C5	28V	0	5.70A	8.55A	11.40A
SNP-G16J-C5	36V	0	4.45A	6.66A	8.90A
SNP-G16T-C5	48V	0	3.35A	5.00A	6.67A

Power supplies which require <0.5W standby mode will create audible burst sound at light load.
 Suffix A & 5 designate no burst sound by removing standby mode operation at 0.5W (which is the stocking standard part number).
 If Standby mode with audible burst noise is required, remove suffix A (minimum quantities may apply).

1. Standby Power Consumption with System: For computers and displays, ENERGY STAR in U.S. and ErP regulation in Europe require the input power should be less than 0.5W at standby mode.
2. Output Load: 160W for convection cooling; 240W for forced air cooling (18 CFM)
3. Peak Load Duration: Peak 320W can last for 5 sec.
4. Isolation Grade: Primary Ground : 1MOPP (1500Vac) / Primary Secondary : 2MOPP (4000Vac) / Secondary Ground : 1MOPP (1500Vac)
5. Leakage Current: Earth leakage current < 300uA / Touch current < 100uA
6. EMI Grounding: / If there is a metal sheet under the power supply, connect the EMI ground to the metal sheet.

Specifications are subject to change without notice. It is responsibility of each customer to thoroughly test each product and part number under their unique parameters and environments to ensure a product will work properly and reliably.

Click below for more details, to buy on-line or request volume pricing:
<http://power.sager.com/skynet-SNP-G16-CM-power-supply.html>

(866) 588-1750
 power@sager.com
<http://power.sager.com>

General Specifications:

Input voltage 90 VAC to 264 VAC
 Input frequency 47 Hz to 63 Hz
 Inrush current < 30/60A at 115/230VAC
 Hold up time 20ms typical
 Over load/Short circuit protection auto recovery
 Over voltage protection latch off
 Operating temperature -20°C to 70°C
 derating: 2.5% / °C > 50°C for convection cooling
 Storage temperature -40°C to +85°C

EMI EN55022 "B", EN61000-3-3
 Harmonics.....EN61000-3-2, class D
 EMS..... EN61000-4-2,-3,-4,-5,-6,-8,-11
 Safety UL/CSA/EN60950-1, 2nd edition
 ANSI/AMMI/CSA/EN60601-1, 3rd edition
 CB report, CE mark, RM report/file
 Energy Saving (for w/o -A suffix) ENERGY STAR
 for computers version 6.0
 for displays version 6.0
 ErP regulation EC(No) 1275/2008

Performance for SNP-G167:

1. Switching frequency ripple

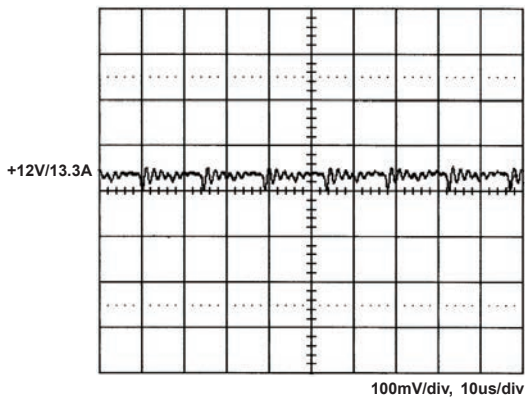

2. Line frequency ripple

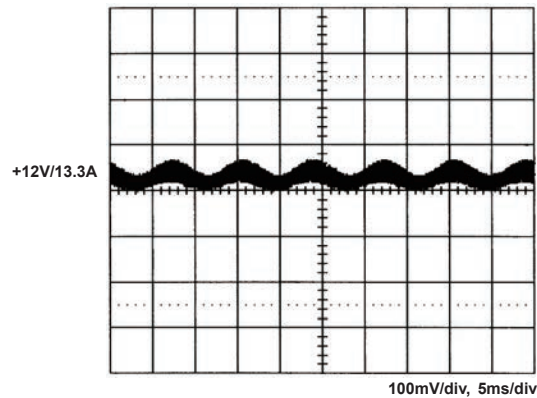

3. Output turn on wave form

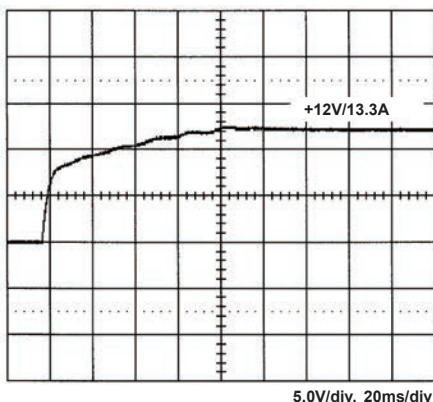

4. Output turn off wave form

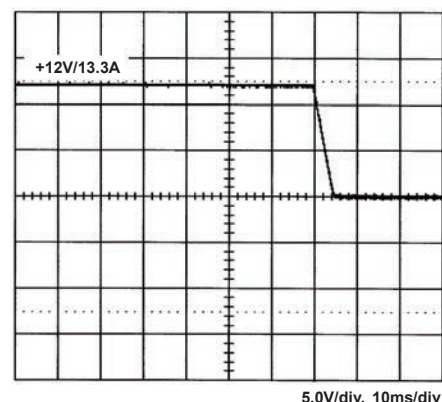

5. Hold-up time

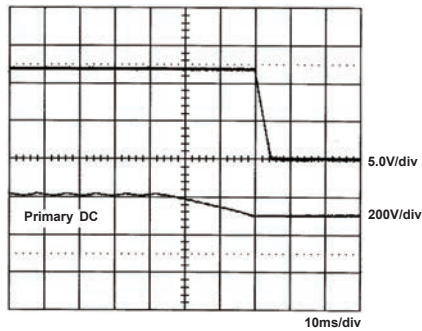

6. Over voltage protection

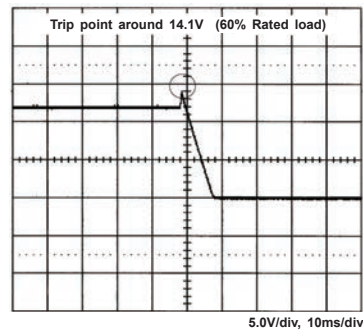

7. +12V step response

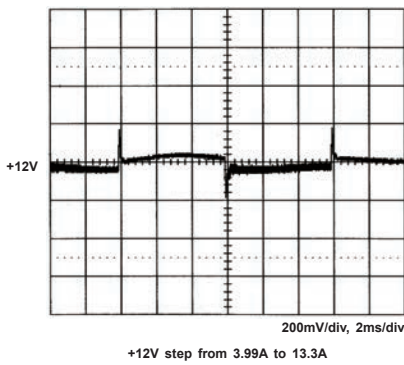

8. Peak load

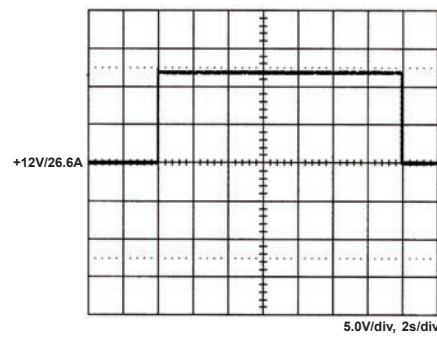

9. FCC B

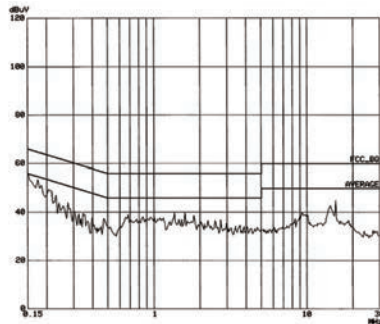

10. EN55022 B

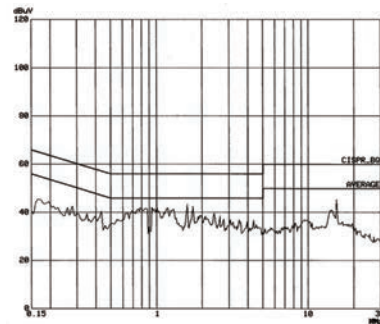

11. Power derating curve

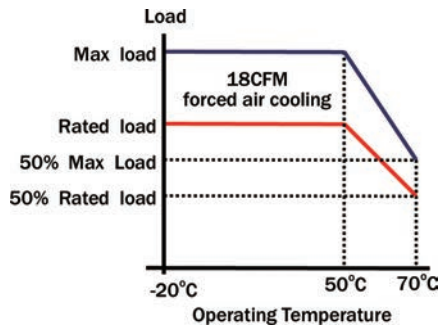

12. Capability for driving motor

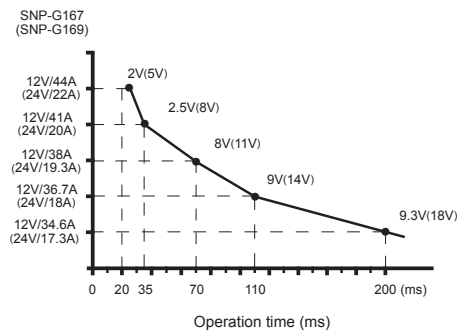

MECHANICAL DRAWING (OPEN-FRAME MODELS)

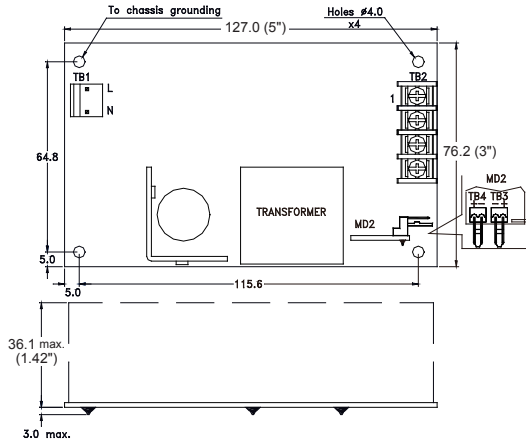

- Size: 3" x 5" x 1.42"
- Mounting Hole: 64.8 x 115.6 (mm)
- Connectors:
AC input: Molex 5277-02A or equivalent
DC output: Terminal blocks (default for SNP-G167) or Molex 5273-08A (default for others) or equivalent
Fan, Remote sense: Molex 5045-02A or equivalent
- Output Pin assignment:

Function Pin	TB3	TB4
1	FAN Output	Remote Sense
2	GND	Sense -
	+12V	Sense +

Pin No.	1	2	3	4	5	6	7	8
SNP-G167	+Vo	+Vo	GND	GND				
OTHER MODELS	+Vo	+Vo	+Vo	+Vo	GND	GND	GND	GND

- Packing:
Net weight: 353 g approx. / unit
Gross weight: 15 kg approx. / carton, 16 units / carton
Carton size (mm): 384 (L) x 339 (W) x 327 (H)

MECHANICAL DRAWING (U-FRAME MODELS)

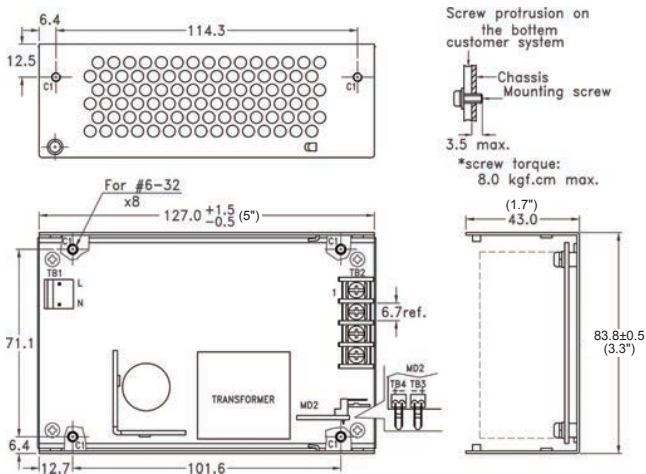

- Notes:**
- Size: Fits 1U Height
 - Mounting Hole: Side edge : 12.5 x 114.3 (mm)
Bottom : 71.1 x 101.6 (mm)
 - Connectors:
AC input: Molex 5277-02A or equivalent
DC output: Terminal blocks (default for SNP-G167-U) or Molex 5273-08A (default for others) or equivalent
Fan, Remote sense: Molex 5045-02A or equivalent
 - Output Pin assignment:

Function Pin	TB3	TB4
1	FAN Output	Remote Sense
2	GND	Sense -
	+12V	Sense +

Pin No.	1	2	3	4	5	6	7	8
SNP-G167-U	+Vo	+Vo	GND	GND				
OTHER MODELS	+Vo	+Vo	+Vo	+Vo	GND	GND	GND	GND

- Packing:
Net weight: 539 g approx. / unit
Gross weight: 15.3 kg approx. / carton, 24 units / carton
Carton size (mm): 384 (L) x 339 (W) x 327 (H)

MECHANICAL DRAWING (ENCLOSED MODELS)

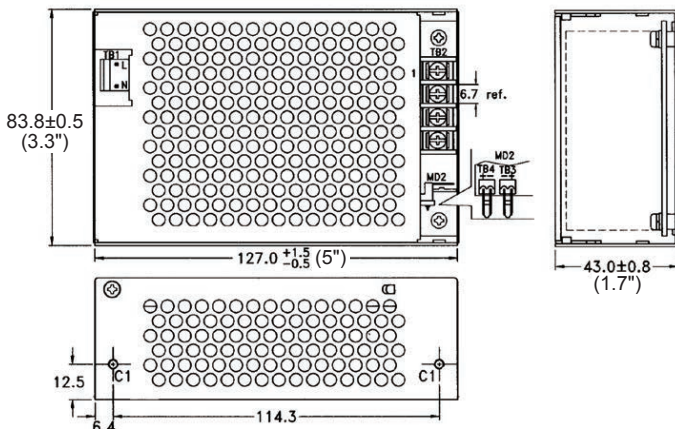

- Notes:**
- Size: Fits 1U Height
 - Mounting Hole: Side edge: 12.5 x 114.3 (mm)
Bottom : 71.1 x 101.6 (mm)
 - Connectors:
AC input: Molex 5277-02A or equivalent
DC output: Terminal blocks (default for SNP-G167-C) or Molex 5273-08A (default for others) or equivalent
Fan, Remote sense: Molex 5045-02A or equivalent
 - Output Pin assignment:

Function Pin	TB3	TB4
1	FAN Output	Remote Sense
2	GND	Sense -
	+12V	Sense +

Pin No.	1	2	3	4	5	6	7	8
SNP-G167-C	+Vo	+Vo	GND	GND				
OTHER MODELS	+Vo	+Vo	+Vo	+Vo	GND	GND	GND	GND

- Packing:
Net weight: 539 g approx. / unit
Gross weight: 16.3 kg approx. / carton, 24 units / carton
Carton size (mm): 384 (L) x 339 (W) x 327 (H)