

PLEASE CHECK WWW.MOLEX.COM FOR LATEST PART INFORMATION

Part Number: [0877823005](#)
Status: **Active**
Overview: MiniDIMM Sockets
Description: 0.60mm Pitch miniDIMM DDR3 Socket, Vertical, Surface Mount, 0.76µm Gold (Au) over Nickel, 1.5V, with Pick and Place Cover, 244 Circuits, Natural (Off White) Latch, Type A Tray, Lead-Free

Documents:

3D Model	Application Specification AS-87782-001-001 (PDF)
Drawing (PDF)	Packaging Specification PK-87782-004 (PDF)
Product Specification PS-87782-027-001 (PDF)	RoHS Certificate of Compliance (PDF)

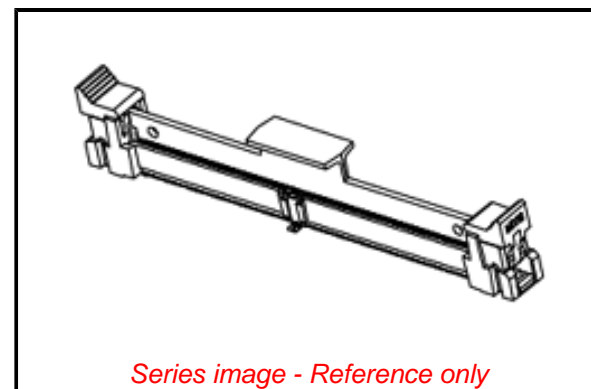

Series image - Reference only

Agency Certification

CSA	LR19980
UL	E29179

General

Product Family	Memory Module Sockets
Series	87782
Comments	With Cap
Component Type	Socket
Electrical Model	Yes
JEDEC Outline	MO-244
Overview	MiniDIMM Sockets
Product Name	MiniDIMM
UPC	883906426224

Physical

Circuits (Loaded)	244
Durability (mating cycles max)	25
Entry Angle	Vertical (Top Entry)
Flammability	94V-0
Housing Color	Black
Keying to Mating Part	Yes
Latch Color	Natural (Off-White)
Material - Metal	Copper Alloy
Material - Plating Mating	Gold
Material - Plating Termination	Tin
Material - Resin	High Temperature Thermoplastic
Net Weight	7.365/g
PCB Locator	Yes
PCB Retention	Yes
Packaging Type	Tray
Pitch - Mating Interface	0.60mm
Pitch - Termination Interface	0.60mm
Plating min - Mating	0.762µm
Plating min - Termination	2.540µm
Temperature Range - Operating	-55°C to +85°C
Termination Interface: Style	Surface Mount

Electrical

Current - Maximum per Contact	1.0A
Voltage - Maximum	30V (RMS)
Voltage Key	1.5V

Solder Process Data

Duration at Max. Process Temperature (seconds)	005
Lead-freeProcess Capability	SMC&WAVE

EU ELV

Not Relevant

EU RoHS

Compliant

REACH SVHC

Not Contained Per
-ED/01/2018 (15
January 2018)

Halogen-Free

Status

Not Low-Halogen

Need more information on product environmental compliance?

Email productcompliance@molex.com
Please visit the [Contact Us](#) section for any non-product compliance questions.

China ROHS	Green Image
ELV	Not Relevant
RoHS Phthalates	Not Contained

Search Parts in this Series

[87782](#) Series

Mates With

JEDEC MO-244 Modules

Max. Cycles at Max. Process Temperature	002
Process Temperature max. C	260

Material Info

Reference - Drawing Numbers

Application Specification	AS-87782-001-001
Electrical Model Document	EE-87782-001, EE-87782-002, EE-87782-003, EE-87782-007
Packaging Specification	PK-87782-004
Product Specification	PS-87782-027-001
S-Parameter Model	SP-87782-001, SP-87782-007
Sales Drawing	SD-87782-001

This document was generated on 07/11/2018

PLEASE CHECK WWW.MOLEX.COM FOR LATEST PART INFORMATION