

PLEASE CHECK WWW.MOLEX.COM FOR LATEST PART INFORMATION

Part Number: **0521031819**
Status: **Active**
Description: 1.00mm (.039") Pitch FFC/FPC Connector, SMT, Right Angle, ZIF, Top Contact Style Receptacle, Tray Packaging, 18 Circuits, Lead-Free

Documents:

[3D Model](#) [Product Specification PS-52103-004 \(PDF\)](#)
[Drawing \(PDF\)](#) [RoHS Certificate of Compliance \(PDF\)](#)

Agency Certification

CSA LR19980
 UL E29179

General

Product Family FFC/FPC Connectors
 Series [52103](#)
 Product Name N/A

Physical

Circuits (Loaded) 18
 Contact Position Top
 Durability (mating cycles max) 30
 Entry Angle 90° Angle
 Flammability 94V-0
 Mated Height 2.70mm (.106")
 Material - Metal Phosphor Bronze
 Material - Plating Mating Tin-Bismuth
 Material - Plating Termination Tin-Bismuth
 Number of Rows 1
 Orientation Right Angle
 PC Tail Length 2.00mm (.079")
 PCB Locator Yes
 PCB Retention Yes
 Packaging Type Tray
 Pitch - Mating Interface 1.00mm (.039")
 Plating min - Mating 1.016µm (40µ")
 Plating min - Termination 1.016µm (40µ")
 Polarized to PCB No
 Stackable No
 Surface Mount Compatible (SMC) N/A
 Temperature Range - Operating -20°C to +85°C
 Termination Interface: Style Surface Mount
 Wire/Cable Type FFC/FPC

Electrical

Current - Maximum per Contact 1A
 Voltage - Maximum 125V

Material Info

Reference - Drawing Numbers

Product Specification PS-52103-004
 Sales Drawing SD-52103-002

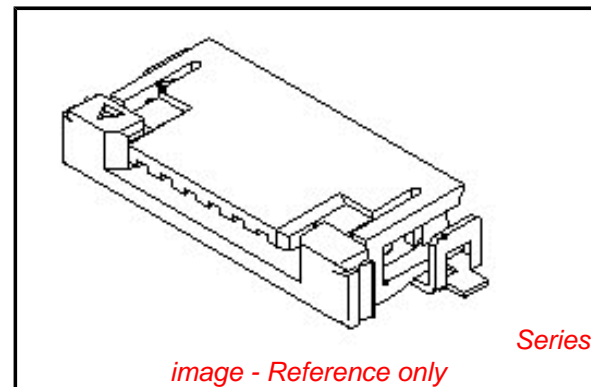

image - Reference only

EU RoHS

**ELV and RoHS
 Compliant**
**REACH SVHC
 Contains SVHC: No
 Low-Halogen Status
 Not Reviewed**

China RoHS



**Need more information on product
 environmental compliance?**

Email productcompliance@molex.com
 For a multiple part number RoHS Certificate of Compliance, [click here](#)

Please visit the [Contact Us](#) section for any non-product compliance questions.

Search Parts in this Series

[52103Series](#)

PLEASE CHECK WWW.MOLEX.COM FOR LATEST PART INFORMATION