

IEC Appliance Inlet C8, Screw-on Mounting, Rear Side, Solder Terminal



0720-FS



See below:

[Approvals and Compliances](#)

**Description**

- Panel Mount :  
Screw-on mounting from rear-side
- 1 Function :  
Appliance Inlet ,
- Pin temperature 70 °C , Protection class II
- Solder terminals

**Characteristics**

- Contact pins rolled

**Weblinks**

[pdf datasheet](#), [html-datasheet](#), [General Product Information](#), [Distributor-Stock-Check](#), [Accessories](#), [Detailed request for product](#)

**Technical Data**

Ratings IEC	2.5 A / 250 VAC; 50 Hz
Ratings UL/CSA	2.5 A / 250 VAC; 60 Hz
Dielectric Strength	> 2 kVAC between L-N (1 min/50 Hz)
Allowable Operation Temperature	-25 °C to 70 °C
IP-Protection	from rear-side IP 40 acc. to IEC 60529
Insulation cover	Suitable for appliances with protection class II acc. to IEC 61140
Terminal	Solder terminals
Panel Thickness S	Screw: max 4 mm Mounting screw torque max 0.5 Nm
Material: Housing	Thermoplastic, black, UL 94V-0

appliance inlet/-outlet	C8 acc. to IEC 60320-1, UL 498, CSA C22.2 no. 42 (for cold conditions) pin-temperature 70 °C, 2.5 A, Protection Class II
-------------------------	--

**Approvals and Compliances**

Detailed information on product approvals, code requirements, usage instructions and detailed test conditions can be looked up in [Details about Approvals](#)

**Approvals**



The approval mark is used by the testing authorities to certify compliance with the safety requirements placed on electronic products.

Approval Reference Type: 0720

Approval Logo	Certificates	Certification Body	Description
	<a href="#">SGSFimko Approvals</a>	SGSFimko	Certificate Number: 2015042
	<a href="#">UL Approvals</a>	UL	UL File Number: E96454
	<a href="#">CSA Approvals</a>	CSA	CSA Certification Record: 73165
	<a href="#">CQC Approvals</a>	CQC	CCC Certificate Number: 2011010204483973

## Product standards

Product standards that are referenced

Organization	Design	Standard	Description
	Designed according to	IEC 60320-1	Appliance couplers for household and similar general purposes
	Designed according to	UL 498	Standard for Attachment Plugs and Receptacles
	Designed according to	CSA C22.2 no. 42	General Use Receptacles, Attachment Plugs, and Similar Wiring Devices





## Application standards

Application standards where the product can be used

Organization	Design	Standard	Description
	Designed for applications acc.	IEC/UL 60950	IEC 60950-1 includes the basic requirements for the safety of information technology equipment.

## Compliances

The product complies with following Guide Lines

Identification	Details	Initiator	Description
	<a href="#">CE declaration of conformity</a>	SCHURTER AG	The CE marking declares that the product complies with the applicable requirements laid down in the harmonisation of Community legislation on its affixing in accordance with EU Regulation 765/2008.
	RoHS	SCHURTER AG	EU Directive RoHS 2011/65/EU
	China RoHS	SCHURTER AG	The law SJ / T 11363-2006 (China RoHS) has been in force since 1 March 2007. It is similar to the EU directive RoHS.
	REACH	SCHURTER AG	On 1 June 2007, Regulation (EC) No 1907/2006 on the Registration, Evaluation, Authorization and Restriction of Chemicals 1 (abbreviated as "REACH") entered into force.

## Dimensions [mm]

0720-FS

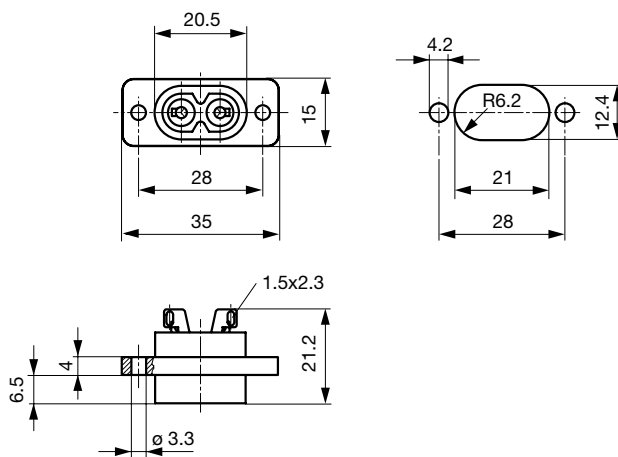

Solder terminals for wires

## All Variants

Type	Panel mounting	Panel Thickness s [mm]	Terminal	Order Number
0720-FS	Screw	4	Solder terminals	4300.0096

Most Popular.

Availability for all products can be searched real-time: <https://www.schurter.com/en/Stock-Check/Stock-Check-SCHURTER>

Packaging unit 100 Pcs

Mating Outlets/Connectors

Category / Description

Power Cord Overview complete



Cord Sets 2.5 A, IEC Connector, Black, 2.0 m, H03VVH2-F 2x0,75mm2, Connector IEC C7, 001500 mm, H03VVH2-F2G0.75, black	6013.0474
Cord Sets 2.5 A, IEC Connector, Black, 4.0 m, H03VVH2-F 2x0,75mm2, Connector IEC C7, 001500 mm, H05VVH2-F2G0.75, black	6013.0478
Kabelverbindung/2.5, IEC Connector, Black, 2.0 m, H03VVH2-F 2x0,75mm2, Connector IEC C7, 001500 mm, H03VVH2-F2G0.75, black	6051.0015

[Power Cord further types to 0720-FS](#)

Power Supply Cord Overview complete



Cord Sets 2.5 A, North America, Black, 2.0 m, SVT 2x18AWG, Connector IEC C7, 002500 mm, NISPT-2, black	6010.5274
Cord Sets 2.5 A, North America, Black, 4.0 m, SVT 2x18AWG, Connector IEC C7, 002500 mm, NISPT-2, black	6010.5278
Kabelverbindung/2.5, North America, Black, 2.5 SVT 2x18AWG, IEC C7, 002500 mm, SVT 2x18 AWG, black	6051.0018

[Power Supply Cord further types to 0720-FS](#)