

PLEASE CHECK WWW.MOLEX.COM FOR LATEST PART INFORMATION

Part Number: [0003061092](#)
Status: **Active**
Overview: Standard .062" Pin and Socket Power Connectors
Description: 1.57mm Diameter Standard .062" Pin and Socket Receptacle Housing, 9 Circuits, without Mounting Ears, Natural

Documents:

[3D Model](#) [Packaging Specification PK-1625-003-001 \(PDF\)](#)
[Drawing \(PDF\)](#) [RoHS Certificate of Compliance \(PDF\)](#)
[Product Specification PS-02-06-001 \(PDF\)](#)

Agency Certification

CSA LR19980
 UL E29179

General

Product Family Crimp Housings
 Series [1625](#)
 Application Power, Wire-to-Wire
 Comments Polarized to Mating Part
 Overview [Standard .062" Pin and Socket Power Connectors](#)
 Product Name Standard .062"
 UPC 800753615571

Physical

Breakaway No
 Circuits (maximum) 9
 Circuits Detail 3x3
 Color - Resin Natural
 Flammability 94V-2
 Gender Receptacle
 Glow-Wire Capable No
 Keying to Mating Part None
 Lock to Mating Part Yes
 Material - Resin Nylon
 Net Weight 2.194/g
 Number of Rows 3
 Packaging Type Bag
 Panel Mount No
 Pitch - Mating Interface 3.68mm
 Pitch - Termination Interface 3.68mm
 Polarized to Mating Part Yes
 Stackable No
 Temperature Range - Operating -40°C to +105°C

Electrical

Current - Maximum per Contact 5.0A

Solder Process Data

Lead-freeProcess Capability N/A

Material Info

Engineering Number 1625-9R1

Reference - Drawing Numbers

Packaging Specification PK-1625-003-001
 Product Specification PS-02-06-001
 Sales Drawing 16250900-SD-000

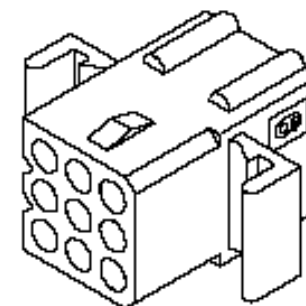

Series image - Reference only

EU ELV

Not Relevant

EU RoHS

Compliant

REACH SVHC

Not Contained Per
 -ED/01/2018 (15
 January 2018)

Halogen-Free

Status

Low-Halogen

Need more information on product environmental compliance?

Email productcompliance@molex.com
 Please visit the [Contact Us](#) section for any non-product compliance questions.

China ROHS

ELV

RoHS Phthalates

Green Image

Not Relevant

Not Contained

Search Parts in this Series

[1625 Series](#)

Mates With

[03-06-2091](#) , [03-06-2092](#)

Use With

Female Crimp Terminals [1561](#) , [4559](#) , [4529](#) , [2190](#) , [2189](#) , [1787](#) , [1855](#) . Male Crimp Terminals [1560](#) , [1786](#) , [1854](#) . [1778](#) Male PC Tail Terminals. [1779](#) Female PC Tail Terminals

This document was generated on 07/11/2018

PLEASE CHECK WWW.MOLEX.COM FOR LATEST PART INFORMATION