

PLEASE CHECK WWW.MOLEX.COM FOR LATEST PART INFORMATION

Part Number: [78079-0071](#)
Status: **Active**
Overview: [DDR3 DIMM](#)
Description: 1.00mm Pitch DDR3 DIMM Socket, Vertical, Through Hole, with Beveled Metal Pins, Black Housing, Off-White Latches, 0.076µm Gold (Au) Plating, 2.67mm Soldertail, 240 Circuits, Lead-Free

Documents:

[3D Model](#) [Product Specification PS-78079-003 \(PDF\)](#)
[Drawing \(PDF\)](#) [RoHS Certificate of Compliance \(PDF\)](#)

Agency Certification

CSA LR19980
 UL E29179

General

Product Family Memory Module Sockets
 Series [78079](#)
 Component Type Socket
 Electrical Model Yes
 JEDEC Outline MO-269
 Overview [DDR3 DIMM](#)
 Product Name DDR3 DIMM
 UPC 800756834795

Physical

Circuits (Loaded) 240
 Circuits (maximum) 240
 Color - Resin Black, Natural
 Durability (mating cycles max) 25
 Entry Angle Vertical
 Flammability 94V-0
 Function Key None
 Keying to Mating Part Yes
 Material - Metal Copper Alloy
 Material - Plating Mating Gold
 Material - Plating Termination Tin
 Material - Resin High Temperature Thermoplastic
 Net Weight 9.283/g
 PC Tail Length 2.67mm
 PCB Locator Yes
 PCB Retention Yes
 PCB Thickness - Recommended 1.57mm
 Packaging Type Tray
 Pitch - Mating Interface 1.00mm
 Pitch - Termination Interface 1.00mm
 Plating min - Mating 0.076µm
 Plating min - Termination 2.540µm
 Temperature Range - Operating -55°C to +85°C
 Termination Interface: Style Through Hole

Electrical

Current - Maximum per Contact 1A
 Voltage - Maximum 30V AC (RMS)/DC
 Voltage Key Center

Solder Process Data

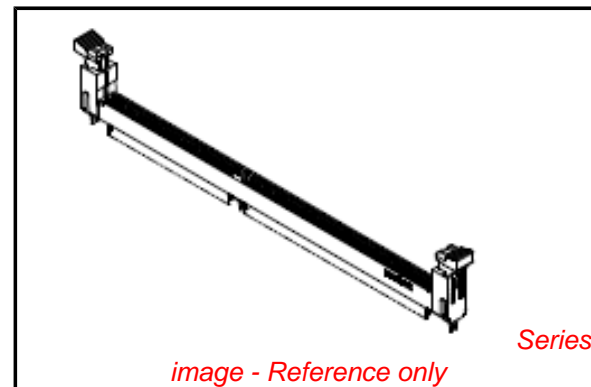

EU RoHS

ELV and RoHS Compliant
REACH SVHC Contains SVHC: No Low-Halogen Status Not Low-Halogen

China RoHS



Need more information on product environmental compliance?

Email productcompliance@molex.com
 For a multiple part number RoHS Certificate of Compliance, [click here](#)

Please visit the [Contact Us](#) section for any non-product compliance questions.

Search Parts in this Series

78079Series

Mates With

JEDEC Standard 1.27mm Modules

Duration at Max. Process Temperature (seconds)	10
Lead-free Process Capability	Wave Capable (TH only)
Max. Cycles at Max. Process Temperature	2
Process Temperature max. C	240

Material Info

Reference - Drawing Numbers

Electrical Model Document	EE-78079-001, EE-78079-002, EE-78079-003, EE-78079-004, EE-78079-005, EE-78079-008
Product Specification	PS-78079-003
S-Parameter Model	SP-78079-008
Sales Drawing	SD-78079-001

This document was generated on 09/08/2014

PLEASE CHECK WWW.MOLEX.COM FOR LATEST PART INFORMATION