

FS Boxes and Covers



Applications :

- FS boxes are CSA approved for wet locations
- FS device boxes are installed in applications that require a rugged unit to accept wiring devices, switches, electronic components and terminal blocks
- FS device boxes provide spacious accessible wiring chambers that are a convenient location to maintain or change a system; pull conductors; make splices or branch conduits
- FS device boxes, when used with an appropriate cover, provide a raintight installation
- Both weatherproof and dry location covers are available

Features/Benefits :

- FS device boxes are sand casted or die casted using copper free (less than 0.004 copper content) aluminum alloys.
- FS device boxes incorporate external hub design that provides maximum wiring capacity
- FS device boxes have precision molded NPT threaded hubs allowing trouble-free field installation of rigid conduit
- FS device boxes are available in 1-7/8 in. and 2-5/8 in. depth
- Carlton® nonmetallic weatherproof FS covers are UV resistant, flame retardant and non-corrosive



Standard Materials :

- CIFS and CIFD device boxes: sand cast, copper free aluminum (less than 0.004 copper content)
- CIFSU: die cast, copper free aluminum (less than 0.004 copper content)
- FS covers: die cast aluminum, sand cast aluminum or nonmetallic



Compliances :

Compliances as noted on each page of the catalogue include:

- CSA Certified
- UL Listed



FS Boxes and Covers



CIFDC-1/2

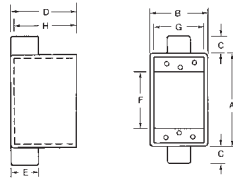

| Cat. No. | Hub Size | No. of Gangs | No. of Lugs | A (in.) | B (in.) | C (in.) | D (in.) | E (in.) | F (in.) | G (in.) | H (in.) | Cu (in.) |
|---|----------|--------------|-------------|---------|---------|---------|---------|---------|---------|---------|---------|----------|
| FDC Boxes - 2-5/8 in. Deep (Cast Aluminum) | | | | | | | | | | | | |
| CIFDC-1/2 | 2 x 1/2 | 1 | 2 | 4-5/16 | 2-13/16 | 15/16 | 2-5/8 | 1-3/8 | 2-7/8 | 2-3/8 | 2-5/32 | 22.5 |
| CIFDC-3/4 | 2 x 3/4 | 1 | 2 | 4-5/16 | 2-13/16 | 15/16 | 2-5/8 | 1-3/8 | 2-7/8 | 2-3/8 | 2-13/32 | 22.5 |
| CIFDC-1 | 2 x 1 | 1 | 2 | 4-5/16 | 2-13/16 | 1-3/8 | 2-5/8 | 1-5/8 | 2-7/8 | 2-3/8 | 2-13/32 | 22.5 |



CIFS-1G

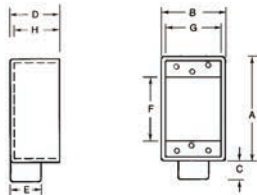

CIFS-2G

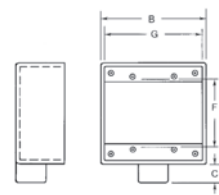

CIFS-3G



| Cat. No. | Hub Size | No. of Gangs | No. of Lugs | A (in.) | B (in.) | C (in.) | D (in.) | E (in.) | F (in.) | G (in.) | H (in.) | Cu (in.) |
|--|----------|--------------|-------------|---------|---------|---------|---------|---------|---------|---------|---------|----------|
| FS Boxes - 1-7/8 in. Deep (Cast Aluminum) | | | | | | | | | | | | |
| CIFS-1G-1/2 | 1 x 1/2 | 1 | 3 | 4-5/16 | 2-13/16 | 13/16 | 1-7/8 | 1-1/4 | 2-7/8 | 2-5/16 | 1-9/16 | 14.0 |
| CIFS-1G-3/4 | 1 x 3/4 | 1 | 3 | 4-5/16 | 2-13/16 | 13/16 | 1-7/8 | 1-1/2 | 2-7/8 | 2-5/16 | 1-9/16 | 14.0 |
| CIFS-1G-1 | 1 x 1 | 1 | 3 | 4-5/16 | 2-13/16 | 13/16 | 1-7/8 | 1-3/4 | 2-7/8 | 2-5/16 | 1-9/16 | 14.0 |
| CIFS-2G-1/2 | 1 x 1/2 | 2 | 3 | 4-3/8 | 4-11/16 | 7/8 | 1-7/8 | 1-1/4 | 2-7/8 | 4-1/4 | 1-5/8 | 26.0 |
| CIFS-2G-3/4 | 1 x 3/4 | 2 | 3 | 4-3/8 | 4-11/16 | 7/8 | 1-7/8 | 1-9/16 | 2-7/8 | 4-1/4 | 1-5/8 | 26.0 |
| CIFS-2G-1 | 1 x 1 | 2 | 3 | 4-3/8 | 4-11/16 | 7/8 | 1-7/8 | 1-3/4 | 2-7/8 | 4-1/4 | 1-5/8 | 26.0 |
| CIFS-3G-1/2 | 1 x 1/2 | 3 | 3 | 4-3/8 | 6-1/2 | 7/8 | 1-7/8 | 1-1/4 | 2-7/8 | 6-1/16 | 1-5/8 | 41.0 |
| CIFS-3G-3/4 | 1 x 3/4 | 3 | 3 | 4-3/8 | 6-1/2 | 7/8 | 1-7/8 | 1-9/16 | 2-7/8 | 6-1/16 | 1-5/8 | 41.0 |

FS Boxes and Covers



CIFSC-1G

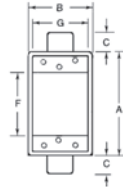

CIFSC-3G-3/4

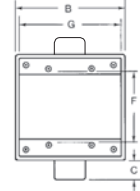

| Cat. No. | Hub Size (in.) | No. of Gangs | No. of Lugs | A (in.) | B (in.) | C (in.) | D (in.) | E (in.) | F (in.) | G (in.) | H (in.) | Cu (in.) |
|---|----------------|--------------|-------------|---------|---------|---------|---------|---------|---------|---------|---------|----------|
| FSC Boxes - 1-7/8 in. Deep (Cast Aluminum) | | | | | | | | | | | | |
| CIFSC-1G-1/2 | 2 x 1/2 | 1 | 4 | 4-5/16 | 2-13/16 | 27/32 | 1-7/8 | 1-1/4 | 2-7/8 | 2-5/16 | 1-9/16 | 14.0 |
| CIFSC-1G-3/4 | 2 x 3/4 | 1 | 4 | 4-5/16 | 2-13/16 | 27/32 | 1-7/8 | 1-1/2 | 2-7/8 | 2-5/16 | 1-9/16 | 14.0 |
| CIFSC-1G-1 | 2 x 1 | 1 | 4 | 4-5/16 | 2-13/16 | 27/32 | 1-7/8 | 1-3/4 | 2-7/8 | 2-5/16 | 1-9/16 | 14.0 |
| CIFSC-2G-1/2 | 2 x 1/2 | 2 | 4 | 4-3/8 | 4-11/16 | 31/32 | 1-7/8 | 1-1/4 | 2-7/8 | 4-1/4 | 1-5/8 | 26.0 |
| CIFSC-2G-3/4 | 2 x 3/4 | 2 | 4 | 4-3/8 | 4-11/16 | 31/32 | 1-7/8 | 1-9/16 | 2-7/8 | 4-1/4 | 1-5/8 | 26.0 |
| CIFSC-2G-1 | 2 x 1 | 2 | 4 | 4-3/8 | 4-11/16 | 31/32 | 1-7/8 | 1-3/4 | 2-7/8 | 4-1/4 | 1-5/8 | 26.0 |
| CIFSC-3G-3/4 | 2 x 3/4 | 3 | 4 | 4-3/8 | 6-1/2 | 29/32 | 1-7/8 | 1-9/16 | 2-7/8 | 6-1/8 | 1-5/8 | 41.0 |



CIFSCC-1G

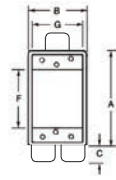

| Cat. No. | Hub Size (in.) | No. of Gangs | No. of Lugs | A (in.) | B (in.) | C (in.) | D (in.) | E (in.) | F (in.) | G (in.) | H (in.) | J (in.) | Cu (in.) |
|--|----------------|--------------|-------------|---------|---------|---------|---------|---------|---------|---------|---------|---------|----------|
| FSCC Boxes - 1-7/8 in. Deep (Cast Aluminum) | | | | | | | | | | | | | |
| CIFSCC-1G-1/2 | 3 x 1/2 | 1 | 3 | 4-5/16 | 2-13/16 | 27/32 | 1-7/8 | 1-1/4 | 2-7/8 | 2-5/16 | 1-9/16 | 1-9/16 | 14.0 |
| CIFSCC-1G-3/4 | 3 x 3/4 | 1 | 3 | 4-5/16 | 2-13/16 | 27/32 | 1-7/8 | 1-1/2 | 2-7/8 | 2-5/16 | 1-9/16 | 1-3/4 | 14.0 |



CIFS-1G-1/2-HV / CIFS-1G-3/4-HV

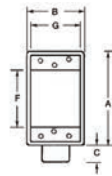

| Cat. No. | Hub Size (in.) | No. of Gangs | No. of Lugs | A (in.) | B (in.) | C (in.) | D (in.) | E (in.) | F (in.) | G (in.) | H (in.) | J (in.) | Cu (in.) |
|--|----------------|--------------|-------------|---------|---------|---------|---------|---------|---------|---------|---------|---------|----------|
| 347 Volt FS Box Kits - 1-7/8 in. Deep (Cast Aluminum) | | | | | | | | | | | | | |
| CIFS-1G-1/2-HV* | 1 x 1/2 | 1 | 3 | 4-5/8 | 2-13/16 | 13/16 | 1-7/8 | 1-1/4 | 2-7/8 | 2-5/16 | 1-9/16 | - | 14.0 |
| CIFS-1G-3/4-HV* | 1 x 3/4 | 1 | 3 | 4-5/8 | 2-13/16 | 13/16 | 1-7/8 | 1-1/2 | 2-7/8 | 2-5/16 | 1-9/16 | - | 14.0 |

* For dry locations only
Includes stamped aluminum "CIFS-9HV" 347 V covers (not raintight)

FS Boxes and Covers



CIFSFS (1 face)



CIFSST (2 faces)

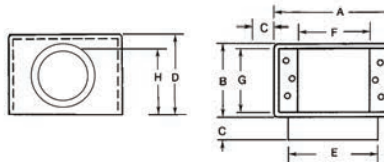

| Cat. No. | Hub Size (in.) | No. of Gangs | No. of Lugs | A (in.) | B (in.) | C (in.) | D (in.) | E (in.) | F (in.) | G (in.) | H (in.) | J (in.) | Cu (in.) |
|---|----------------|--------------|-------------|---------|---------|---------|---------|---------|---------|---------|---------|---------|----------|
| FSF Box - 3 in. Deep (Cast Aluminum) | | | | | | | | | | | | | |
| CIFSFS | 2 | - | - | 4-5/16 | 2-3/4 | 31/32 | 2-7/8 | 2-7/8 | 2-13/16 | 2-13/32 | 1-15/32 | - | 30.5 |
| FST Box - 3-5/8 in. Deep (Cast Aluminum) | | | | | | | | | | | | | |
| CIFSST | 2 | - | - | 4-5/16 | 2-3/4 | 1-3/8 | 3-3/8 | 3 | 2-7/8 | 2-5/16 | 2-13/16 | - | 38.7 |



CIFSU

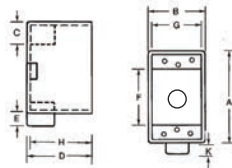

| Cat. No. | Hub Size (in.) | | No. of Lugs | A (in.) | B (in.) | C (in.) | D (in.) | E (in.) | F (in.) | G (in.) | H (in.) | K (in.) | Cu (in.) |
|---|----------------|---------------|-------------|---------|---------|---------|---------|---------|---------|---------|---------|---------|----------|
| Universal FSU Boxes - 2-3/8 in. Deep (Cast Aluminum) | | | | | | | | | | | | | |
| | End | Bottom | | | | | | | | | | | |
| CIFSU-1/2 | 2 x 1/2 | 1/2 | 2 | 4-5/16 | 2-3/4 | 13/16 | 2-3/8 | 1-1/8 | 2-13/16 | 2-1/2 | 1-29/32 | 7/16 | 18.5 |
| CIFSU-3/4 | 2 x 3/4 | 3/4 | 2 | 4-5/16 | 2-3/4 | 13/16 | 2-3/8 | 1-1/8 | 2-13/16 | 2-1/2 | 2 | 7/16 | 18.5 |

Supplied with close up plugs



FG-09080

| Cat. No. | Description |
|---------------------------------|--|
| Mounting Lugs for CI-FSU | |
| FG-09080 | Mounting lugs for a 3-Hole universal FSU box, 2-3/8 in. deep |

FS Boxes and Covers

Single Gang

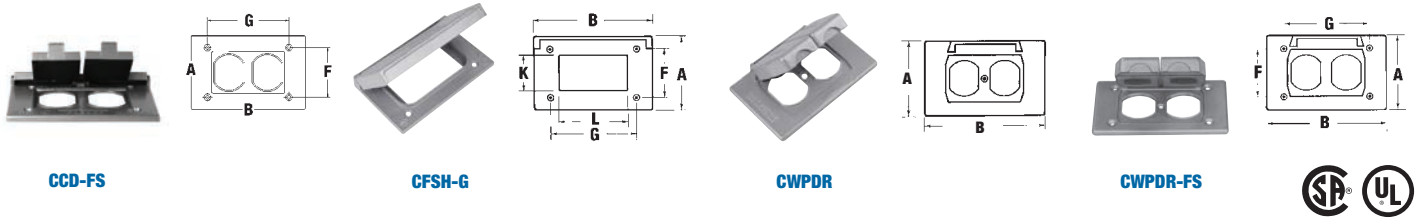

| Cat. No. | Description | A (in.) | B (in.) | F (in.) | G (in.) | K (in.) | L (in.) |
|--|--------------------------------------|---------|---------|---------|---------|---------|---------|
| Single Gang Horizontal Covers (Cast Aluminum) | | | | | | | |
| CCD-FS | Silver – box mount (zinc) | 2-13/16 | 4-9/16 | 1-7/8 | 3-1/4 | – | – |
| CFSH-G | One GFCI receptacle – box mount | 2-13/16 | 4-9/16 | 1-7/8 | 3-1/4 | 1-11/32 | 2-21/32 |
| CWPDR | One duplex receptacle – device mount | 2-13/16 | 4-9/16 | – | – | – | – |
| CWPDR-FS | One duplex receptacle – box mount | 2-13/16 | 4-9/16 | 1-7/8 | 3-1/4 | – | – |

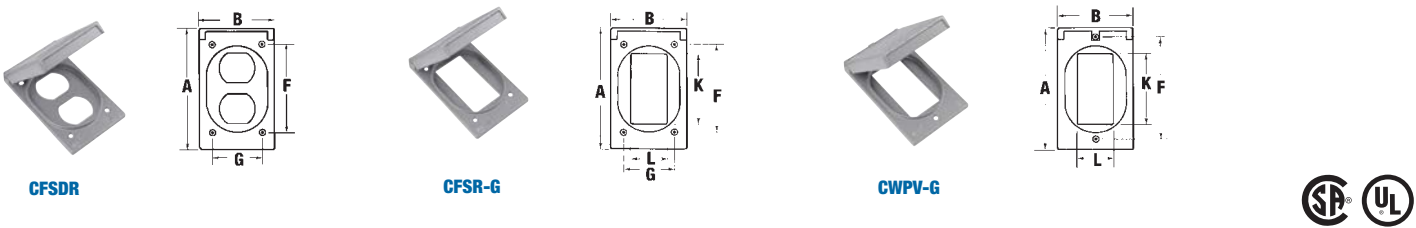

| Cat. No. | Description | A (in.) | B (in.) | F (in.) | G (in.) | K (in.) | L (in.) |
|--|------------------------------------|---------|---------|---------|---------|---------|---------|
| Single Gang Vertical Covers (Cast Aluminum) | | | | | | | |
| CFSDR | One duplex receptacle – box mount | 4-9/16 | 2-13/16 | 3-1/4 | 1-7/8 | – | – |
| CFSR-G | One GFCI receptacle – box mount | 4-9/16 | 2-13/16 | 3-1/4 | | 2-21/32 | 1-11/32 |
| CWPV-G | One GFCI receptacle – device mount | 4-9/16 | 2-13/16 | 3-1/4 | – | 2-21/32 | 1-11/32 |

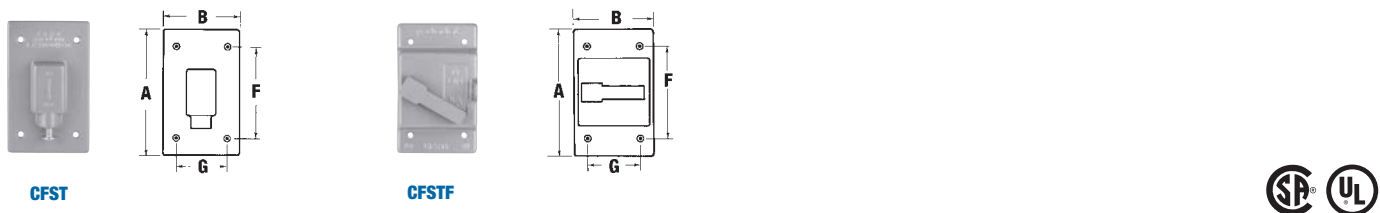

| Cat. No. | Description | A (in.) | B (in.) | F (in.) | G (in.) |
|--|------------------------------|---------|---------|---------|---------|
| Single Gang Switch Covers (Cast Aluminum) | | | | | |
| CFST | One plunger – box mount | 4-9/16 | 2-13/16 | 3-1/4 | 1-7/8 |
| CFSTF | One lever switch – box mount | 4-9/16 | 2-13/16 | 3-1/4 | 1-7/8 |

FS Boxes and Covers

Single Gang



CCB

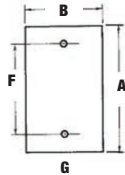

CCB-FS



CFSB

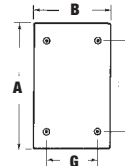

CIFS-100G



| N° de catalogue | Description | A (in.) | B (in.) | F (in.) | G (in.) |
|---|---|---------|---------|---------|---------|
| Single Gang Blank Covers (Cast Aluminum) | | | | | |
| CCB | Silver – device mount (stamped aluminum) | 4-9/16 | 2-13/16 | 3-9/32 | – |
| CCB-FS | Silver – box mount (stamped aluminum) | 4-9/16 | 2-13/16 | 3-1/4 | 1-7/8 |
| CFSB | Blank – box mount | 4-9/16 | 2-13/16 | 3-1/4 | 1-7/8 |
| CIFS-100G | Blank – box mount (gasket glued on cover) | 4-3/8 | 2-14/16 | 3-1/4 | 1-7/8 |



CFSR Series

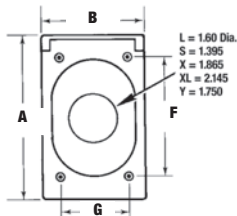

| Cat. No. | Description | Nominal Size (in.) | Max. Device Face Dia. | A (in.) | B (in.) | F (in.) | G (in.) |
|--|-------------------------------|--------------------|-----------------------|---------|---------|---------|---------|
| Single Gang Vertical Covers (Cast Aluminum) | | | | | | | |
| CFSR-L | Single receptacle – box mount | 1-9/16 | 1.600 | 4-9/16 | 2-13/16 | 3-1/4 | 1-7/8 |
| CFSR-S | Single receptacle – box mount | 1-3/8 | 1.395 | 4-9/16 | 2-13/16 | 3-1/4 | 1-7/8 |
| CFSR-X | Single receptacle – box mount | 1-27/32 | 1.865 | 4-9/16 | 2-13/16 | 3-1/4 | 1-7/8 |
| CFSR-XL | Single receptacle – box mount | 2-1/8 | 2.145 | 4-9/16 | 2-13/16 | 3-1/4 | 1-7/8 |
| CFSR-Y | Single receptacle – box mount | 1-3/4 | 1.750 | 4-9/16 | 2-13/16 | 3-1/4 | 1-7/8 |



FS-GKV

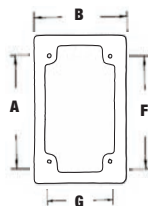

| Cat. No. | Description | A (in.) | B (in.) | F (in.) | G (in.) |
|---------------------------|----------------------------------|---------|---------|---------|---------|
| Single Gang Gasket | | | | | |
| FS-GKV* | Single Gang – box mount – gasket | 4-9/16 | 2-13/16 | 3-1/4 | 1-7/8 |

* CSA not applicable

FS Boxes and Covers

Two Gang



2CWPDR

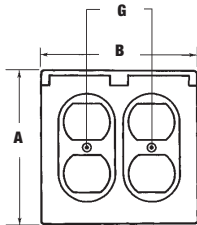

2CWPR-M

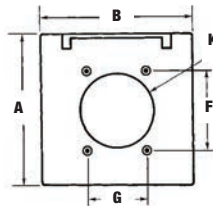

2CFSR-M

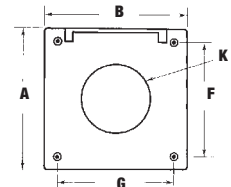

2CFST

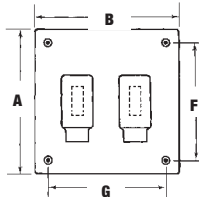

2CCB

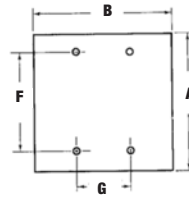

2CFSB

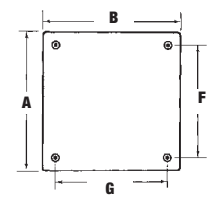

| Cat. No. | Description | A (in.) | B (in.) | F (in.) | G (in.) | K (in.) |
|---------------------------------|--|---------|---------|---------|---------|---------|
| Two Gang (Cast Aluminum) | | | | | | |
| 2CWPDR | Two duplex receptacles – device mount | 4-9/16 | 4-5/8 | – | 1-13/16 | – |
| 2CWPR-M | Single receptacle – hole – device mount | 4-9/16 | 4-5/8 | 2-3/8 | 1-13/16 | 2-1/4 |
| 2CFSR-M | Single receptacle – hole – box mount | 4-9/16 | 4-5/8 | 3-3/4 | 3-3/4 | 2-1/4 |
| 2CFST | Plunger style cover | 4-9/16 | 4-5/8 | 3-3/4 | 3-3/4 | – |
| 2CCB | Silver – device mount (stamped aluminum) | 4-9/16 | 4-5/8 | 3-9/32 | 1-13/16 | – |
| 2CFSB | Blank cover – box mount | 4-9/16 | 4-5/8 | 3-3/4 | 3-3/4 | – |

FS Boxes and Covers

Dry-Tite® FS Covers Two Gang

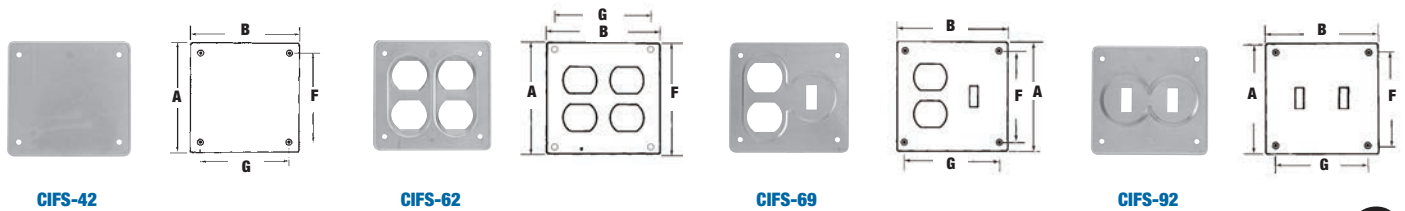

| Cat. No. | Description | A (in.) | B (in.) | F (in.) | G (in.) |
|---|---|---------|---------|---------|---------|
| Two gang FS Covers* (Stamped Aluminum) | | | | | |
| CIFS-42* | Blank – two gang – box mount | 4-5/8 | 4-9/16 | 3-1/4 | 3-11/16 |
| CIFS-62* | Two duplex receptacles – box mount | 4-5/8 | 4-9/16 | 3-1/4 | 3-11/16 |
| CIFS-69* | One duplex receptacles, one toggle switch – box mount | 4-5/8 | 4-9/16 | 3-1/4 | 3-11/16 |
| CIFS-92* | Two toggle switches – box mount | 4-5/8 | 4-9/16 | 3-1/4 | 3-11/16 |

* CIFS covers are CSA approved only

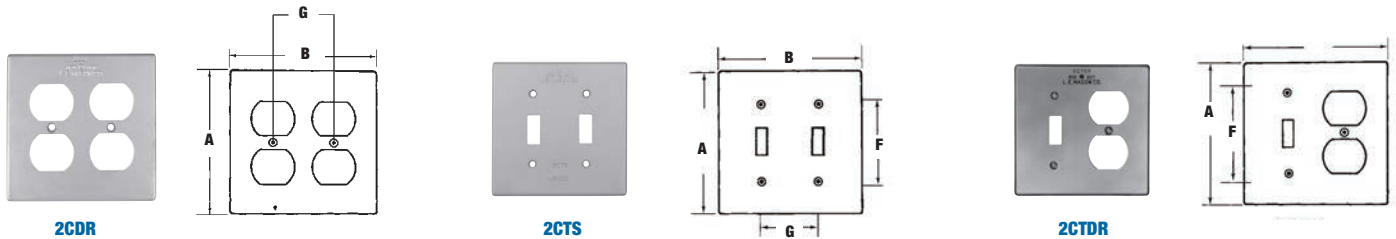

| Cat. No. | Description | A (in.) | B (in.) | F (in.) | G (in.) |
|---------------------------------|---|---------|---------|---------|---------|
| Two Gang (Cast Aluminum) | | | | | |
| 2CDR | Two duplex receptacles – device mount | 4-9/16 | 4-5/8 | – | 1-13/16 |
| 2CTS | Two switch – device mount | 4-9/16 | 4-5/8 | 2-3/8 | 1-13/16 |
| 2CTDR | One switch and one duplex receptacle – device mount | 4-9/16 | 4-5/8 | 2-3/8 | – |

Dry-Tite® covers are approved for dry locations only

FS Boxes and Covers

Dry-Tite® FS Covers Single Gang



CDR

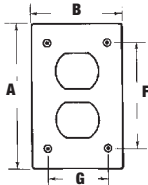

CTS

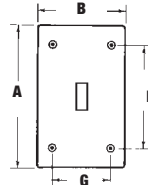

| Cat. No. | Description | A (in.) | B (in.) | F (in.) | G (in.) |
|------------------------------------|-----------------------------------|---------|---------|---------|---------|
| Single Gang (Cast Aluminum) | | | | | |
| CDR | One duplex receptacle – box mount | 4-9/16 | 2-13/16 | 3-1/4 | 1-7/8 |
| CTS | One switch receptacle – box mount | 4-9/16 | 2-13/16 | 3-1/4 | 1-7/8 |



CIFS-4

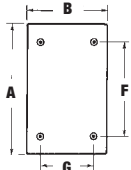

CIFS-7 / CIFS-5



CIFS-6

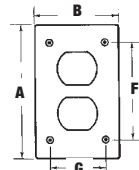

CIFS-9



CIFS-9-HV

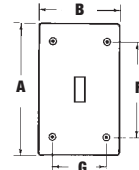

| Cat. No. | Description | A (in.) | B (in.) | F (in.) | G (in.) | K (in.) |
|---|--|---------|---------|---------|---------|---------|
| Single Gang FS Covers (Stamped Aluminum) | | | | | | |
| CIFS-4 | Blank – single gang – box mount | 4-9/16 | 2-13/16 | 3-1/4 | 1-7/8 | – |
| CIFS-5 | 15 A single receptacle – box mount | 4-9/16 | 2-13/16 | 3-1/4 | 1-7/8 | 1-13/16 |
| CIFS-6 | One duplex receptacle – box mount | 4-9/16 | 2-13/16 | 3-1/4 | 1-7/8 | – |
| CIFS-7 | 20 A single locking receptacle – box mount | 4-9/16 | 2-13/16 | 3-1/4 | 1-7/8 | 1-19/32 |
| CIFS-9 | One toggle switch – box mount | 4-9/16 | 2-13/16 | 3-1/4 | 1-7/8 | – |
| CIFS-9-HV | One toggle switch (347 V) – box mount | 4-9/16 | 2-13/16 | 3-1/4 | 1-7/8 | – |



CRL

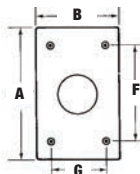

| Cat. No. | Description | Nominal Size (in.) | Max. Device Face Dia. | A (in.) | B (in.) | F (in.) | G (in.) |
|------------------------------------|-------------------------------|--------------------|-----------------------|---------|---------|---------|---------|
| Single Gang (Cast Aluminum) | | | | | | | |
| CRL | Single receptacle – box mount | 1-9/16 | 1.600 | 4-9/16 | 2-13/16 | 3-1/4 | 1-7/8 |
| CRS | Single receptacle – box mount | 1-3/8 | 1.395 | 4-9/16 | 2-13/16 | 3-1/4 | 1-7/8 |

Dry-Tite® covers are approved for dry locations only

FS Boxes and Covers

Single Gang

All sizes take standard covers and accessories or devices. Integral mounting feet provide easy mounting. Grounding lugs included.

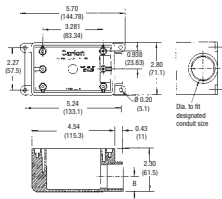

Type FSE

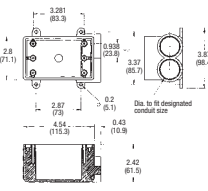

Type FSS

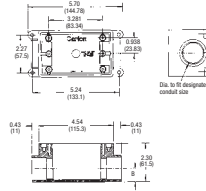

Type FSC

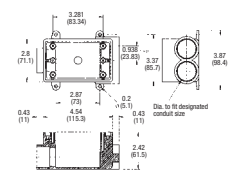

Type FSCC

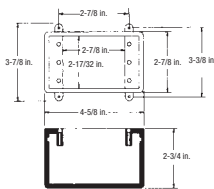

Type FD

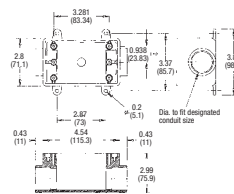

Type FDC

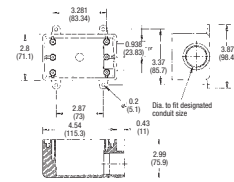

Type FDE



| Cat. No. | Description | Size (in.) | Volume Cu. In. | Std. Ctn. Qty. |
|--------------------|---|------------|----------------|----------------|
| Type FSE | | | | |
| C980DFN-CTN | For dead-end terminations. | 1/2 | 18 | 12 |
| C980EFN-CTN | | 3/4 | 18 | 12 |
| C980FFN-CTN | | 1 | 18 | 8 |
| Type FSS | | | | |
| C982DFN-CTN | For multiple dead-end circuit terminations or where additional support is required in stub-up applications. | 1/2 | 18 | 12 |
| C982EFN-CTN | | 3/4 | 18 | 12 |
| C982FFN-CTN | | 1 | 18 | 8 |
| Type FSC | | | | |
| C981DFN-CTN | For through terminations. | 1/2 | 18 | 12 |
| C981EFN-CTN | | 3/4 | 18 | 12 |
| C981FFN-CTN | | 1 | 18 | 8 |
| Type FSCC | | | | |
| C979DFN | For multiple through circuit terminations or where additional support is required in stub-up applications. | 1/2 | 18 | 15 |
| C979EFN | | 3/4 | 18 | 15 |
| C979FFN | | 1 | 18 | 15 |

| Cat. No. | Description | Size (in.) | Volume Cu. In. | Std. Ctn. Qty. |
|--------------------|--|------------|----------------|----------------|
| Type FD | | | | |
| C981DFN-CTN | For terminations where hub requirements vary according to application – hubs easily made with flared wood bit or hole saw. | – | 25 | 10 |
| Type FDC | | | | |
| C9811EN | For through terminations where large devices or additional wiring capacity is required. | 3/4 | 25 | 10 |
| C9811FN | | 1 | 25 | 10 |
| Type FDE | | | | |
| C9801DN | For dead-end terminations where large devices or additional wiring capacity is required. | 1/2 | 25 | 10 |
| C9801EN | | 3/4 | 25 | 10 |
| C9801FN | | 1 | 25 | 10 |

FS Boxes and Covers

Single Gang



E98SRCN-CAR



E98G20N



E98G30N-CAR



E98G5FN-CAR

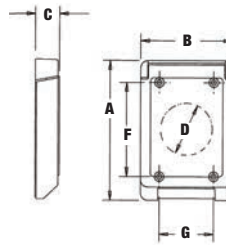

| Cat. No. | Description | Colour | A (in.) | B (in.) | C (in.) | D (in.) | F (in.) | G (in.) |
|--|---|--------|---------|---------|---------|-------------------|---------|---------|
| Single Gang Vertical Covers (Nonmetallic) | | | | | | | | |
| E98SRCN-CAR | For 15 A or other single receptacles under 1.375 dia. | Grey | 4-53/64 | 3-11/16 | 53/64 | 1-25/64 ± 1/16 | 3-1/4 | 1-57/64 |
| E98G20N | For 20 A or other single receptacles under 1.625 dia. | Grey | 4-53/64 | 3-11/16 | 53/64 | 1-41/64 ± 1-23/32 | 3-1/4 | 1-57/64 |
| E98G30N-CAR | For 30 A or other single receptacles under 1.750 dia. | Grey | 4-53/64 | 3-11/16 | 53/64 | 1-49/64 ± 1-23/32 | 3-1/4 | 1-57/64 |
| E98G5FN-CAR | For 50 A or other single receptacles under 2.250 dia. | Grey | 4-53/64 | 3-11/16 | 53/64 | 2-1/4 ± 1/16 | 3-1/4 | 1-57/64 |



E98GCBN



E98SSCN-CAR



E98GDRN-CAR



E98GFNC-CAR

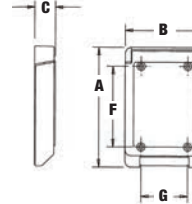

| Cat. No. | Description | Colour | A (in.) | B (in.) | C (in.) | F (in.) | G (in.) |
|--|---|--------|---------|---------|---------|---------|---------|
| Single Gang Vertical Covers (Nonmetallic) | | | | | | | |
| E98SSCN-CAR | Single switch | Grey | 4-53/64 | 3-11/16 | 53/64 | 3-1/4 | 1-57/64 |
| E98GDRN-CAR | Duplex receptacle | Grey | 4-53/64 | 3-11/16 | 53/64 | 3-1/4 | 1-57/64 |
| E98GFNC-CAR | GFCI receptacle – device opening dimensions: 2-5/8 H x 1-5/16 W | Grey | 4-53/64 | 3-11/16 | 53/64 | 3-1/4 | 1-57/64 |



E98TSCN

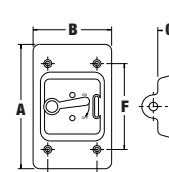

E980CN-CAR

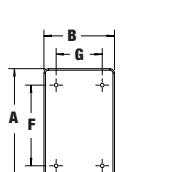

| Cat. No. | Description | Colour | A (in.) | B (in.) | C (in.) | F (in.) | G (in.) |
|--|--|--------|---------|---------|---------|---------|---------|
| Single Gang Vertical Covers (Nonmetallic) | | | | | | | |
| E98TSCN | Toggle switch | Grey | 4-3/4 | 3 | 31/32 | 3-9/32 | 1-57/64 |
| E980CN-CAR | Supplied with stainless steel mounting screws and gasket | Grey | 4-5/8 | 2-7/8 | – | 3-9/32 | 1-57/64 |
| E980CM-CAR | Supplied with stainless steel mounting screws and gasket | White | 4-5/8 | 2-7/8 | – | 3-9/32 | 1-57/64 |



E98DHGN-CAR



E98GHGN-CAR

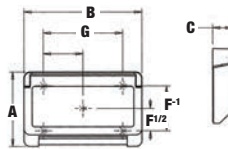

| Cat. No. | Description | Colour | A (in.) | B (in.) | C (in.) | F1 (in.) | F1/2 (in.) | G (in.) |
|--|-------------------|--------|---------|---------|---------|----------|------------|---------|
| Single Gang Horizontal Covers (Nonmetallic) | | | | | | | | |
| E98DHGN-CAR | Duplex receptacle | Grey | 3-1/8 | 4-7/8 | 13/16 | 1-57/64 | 61/64 | 3-9/32 |
| E98GHGN-CAR | GFCI horizontal | Grey | 3-1/8 | 4-7/8 | 13/16 | 1-57/64 | 61/64 | 3-9/32 |

FS Boxes and Covers

Two Gang

All sizes take standard covers and accessories or devices. Integral mounting feet provide easy mounting. Grounding screws are included.

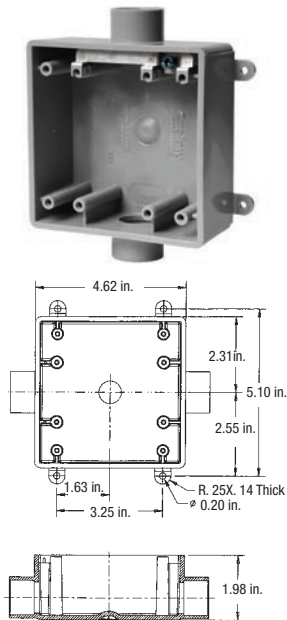

Type 2FSC

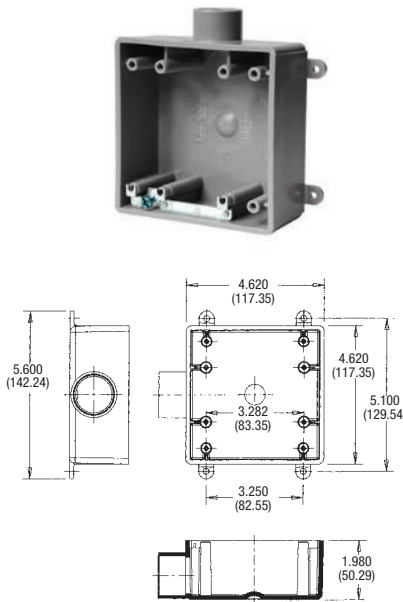

Type 2FSE

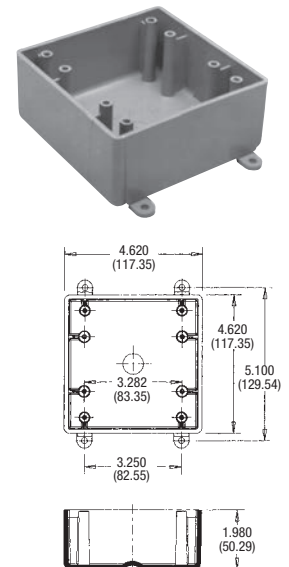

Type FS



| Cat. No. | Description | Size (in.) | Volume Cu. In. | Std. Ctn. Qty. |
|--------------------|--|------------|----------------|----------------|
| Type 2FSC | | | | |
| CE9812DR | | 1/2 | 32 | 4 |
| CE9812E-CTN | For through terminations where two devices or additional wiring capacity is required. | 3/4 | 32 | 10 |
| CE9812FR | | 1 | 32 | 10 |
| Type 2FSE | | | | |
| CE9802D-CTN | | 1/2 | 18 | 10 |
| CE9802E-CTN | For dead-end terminations where two devices or additional wiring capacity is required. | 3/4 | 18 | 10 |
| CE9802FR | | 1 | 18 | 1 |
| Type FS | | | | |
| CE9802 | For terminations where hub requirements vary according to application - hubs easily made with flared wood bit or hole saw. | N/A | 32 | 10 |

FS Boxes and Covers

Two Gang



E9G2DDN-CAR

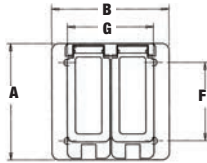

E9G2SSN

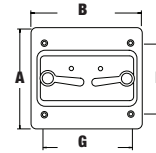

E9G2DSN-CAR



E9G2GTN-CAR

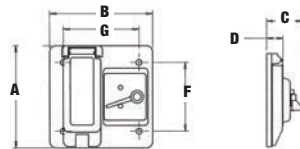

E9802CN-CAR

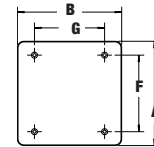

| Cat. No. | Description | Colour | A (in.) | B (in.) | C (in.) | D (in.) | F (in.) | G (in.) |
|--------------------------------------|--|--------|---------|---------|---------|---------|---------|---------|
| Two Gang Covers (Nonmetallic) | | | | | | | | |
| E9G2DDN-CAR | Double duplex | Grey | 4-27/34 | 4-27/34 | – | – | 3-17/64 | 3-9/16 |
| E9G2SSN | Double toggle | Grey | 4-55/64 | 3-17/64 | – | – | 3-17/64 | 3-9/16 |
| E9802CN-CAR | Supplied with stainless steel mounting screws and gasket | Grey | 4-55/64 | 4-55/64 | – | – | 3-17/64 | 3-9/16 |
| E9G2GTN-CAR | Combination toggle / GFCI | Grey | 4-55/64 | 3-17/64 | 1-53/64 | 55/64 | 3-17/64 | 3-9/16 |
| E9G2DSN-CAR | Combination toggle / duplex receptacle | Grey | 4-55/64 | 3-17/64 | 1-53/64 | 55/64 | 3-17/64 | 3-9/16 |