



# 60×60×20 mm

San Ace 60 9GA type Low Power Consumption Fan

## General Specifications

- Material ..... Frame: Plastic (Flammability: UL 94V-0), Impeller: Plastic (Flammability: UL 94V-0)
- Expected life ..... See the table below. (L10 life: 90% survival rate for continuous operation in free air at 60°C, rated voltage)
- Motor protection function ..... Locked rotor burnout protection, Reverse polarity protection  
For details, please refer to p. 529.
- Dielectric strength ..... 50/60 Hz, 500 VAC, for 1 minute (between lead wire conductors and frame)
- Insulation resistance ..... 10 MΩ or more with a 500 VDC megger (between lead wire conductors and frame)
- Sound pressure level (SPL) ..... At 1 m away from the air inlet
- Storage temperature ..... -30 to +70°C (Non-condensing)
- Lead wire ..... ⊕Red ⊖Black (Sensor) Yellow (Control) Brown  
(For models without PWM control function, there is no speed control wiring.)
- Mass ..... 70 g

## Specifications

The models listed below **have ribs and pulse sensors with PWM control function.**

Model no.	Rated voltage [V]	Operating voltage range [V]	PWM duty cycle* [%]	Rated current [A]	Rated input [W]	Rated speed [min <sup>-1</sup> ]	Max. airflow [m <sup>3</sup> /min] [CFM]	Max. static pressure [Pa] [inchH <sub>2</sub> O]	SPL [dB (A)]	Operating temperature [°C]	Expected life [h]
9GA0612P6G001	12	10.8 to 13.2	100	0.26	3.12	6850	0.88 31.1	125 0.5	43	-20 to +70	40000/60°C (70000/40°C)
9GA0612P6S001			100	0.15	1.8	5500	0.7 24.7	81 0.33	36		
9GA0624P6G001	24	21.6 to 26.4	100	0.12	2.88	6850	0.88 31.1	125 0.5	43		
9GA0624P6S001			100	0.07	1.68	5500	0.7 24.7	81 0.33	36		

\* PWM frequency: 25 kHz. Fan does not rotate when PWM duty cycle is 0%.

The models listed below **have ribs and pulse sensors.**

Model no.	Rated voltage [V]	Operating voltage range [V]	Rated current [A]	Rated input [W]	Rated speed [min <sup>-1</sup> ]	Max. airflow [m <sup>3</sup> /min] [CFM]	Max. static pressure [Pa] [inchH <sub>2</sub> O]	SPL [dB (A)]	Operating temperature [°C]	Expected life [h]
9GA0612H6001	12	10.8 to 13.2	0.09	1.08	4100	0.52 18.4	45 0.18	29	-20 to +70	60000/60°C
9GA0612M6001			0.05	0.6	2700	0.34 12.0	20 0.08	18		
9GA0624H6001	24	21.6 to 26.4	0.04	0.96	4100	0.52 18.4	45 0.18	29		
9GA0624M6001			0.03	0.72	2700	0.34 12.0	20 0.08	18		

Other sensor specifications are available as options. Refer to the index (pp. 551 to 552).

## Airflow - Static Pressure Characteristics / PWM Duty - Speed Characteristics Example

**9GA0612P6G001** With pulse sensor with PWM control function

PWM duty cycle

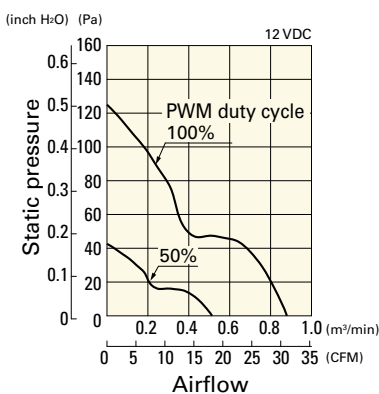

Operating voltage range

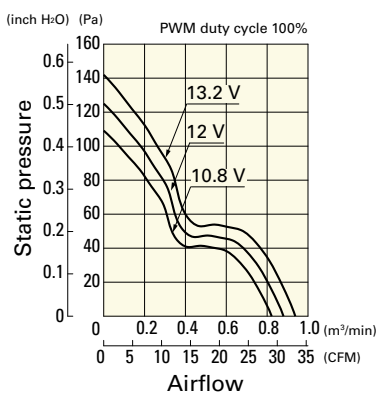

PWM duty - Speed characteristics example

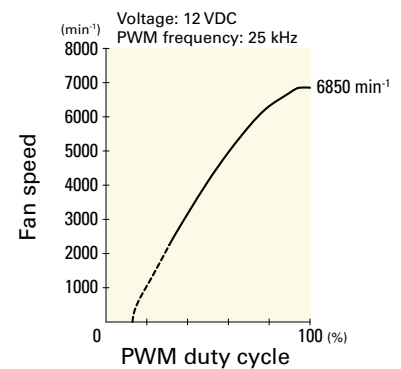

# Airflow - Static Pressure Characteristics / PWM Duty - Speed Characteristics Example

**9GA0612P6S001** With pulse sensor with PWM control function

PWM duty cycle

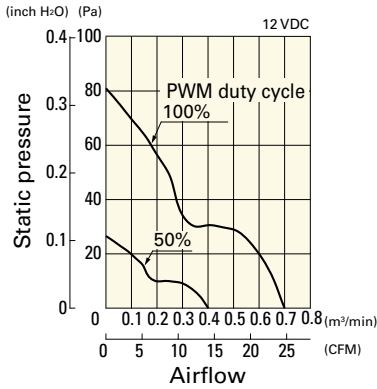

Operating voltage range

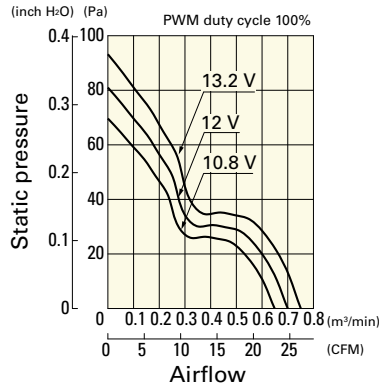

PWM duty - Speed characteristics example

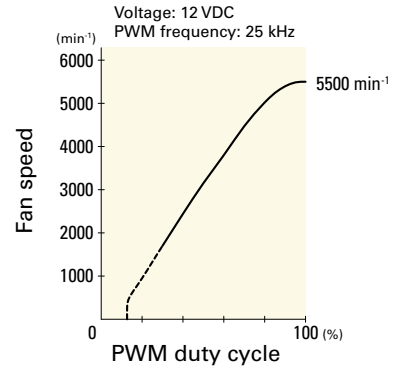

**9GA0624P6G001** With pulse sensor with PWM control function

PWM duty cycle

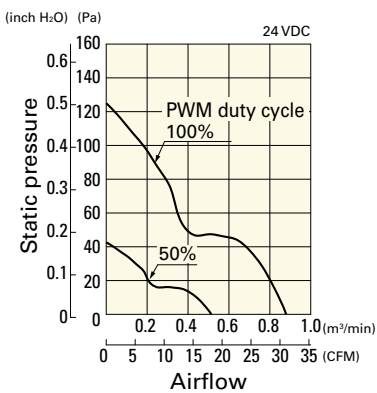

Operating voltage range

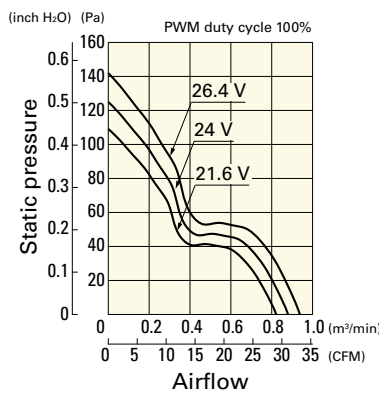

PWM duty - Speed characteristics example

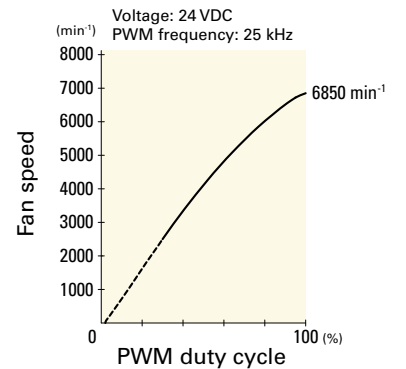

**9GA0624P6S001** With pulse sensor with PWM control function

PWM duty cycle

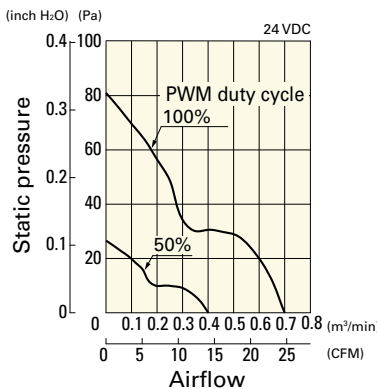

Operating voltage range

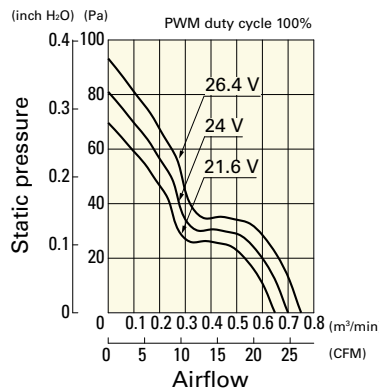

PWM duty - Speed characteristics example

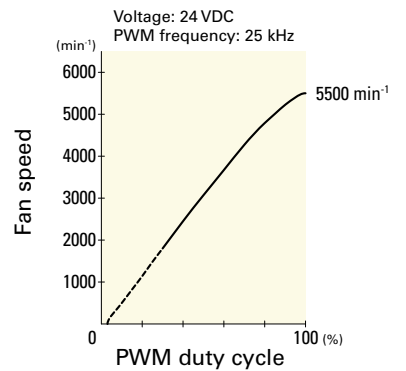

**9GA0612H6001** With pulse sensor

Operating voltage range

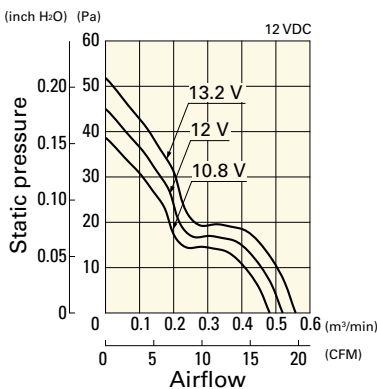

**9GA0612M6001** With pulse sensor

Operating voltage range

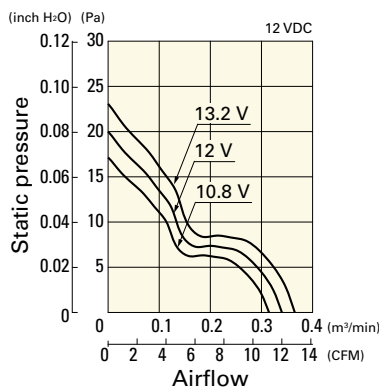

**9GA0624H6001** With pulse sensor

Operating voltage range

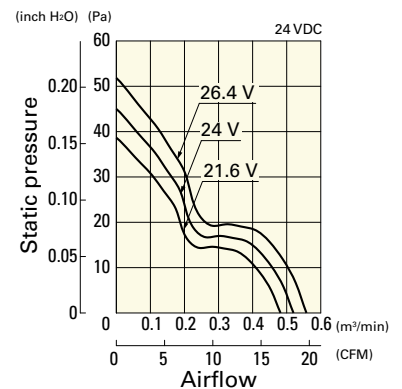

**Airflow - Static Pressure Characteristics**

**9GA0624M6001** With pulse sensor

Operating voltage range

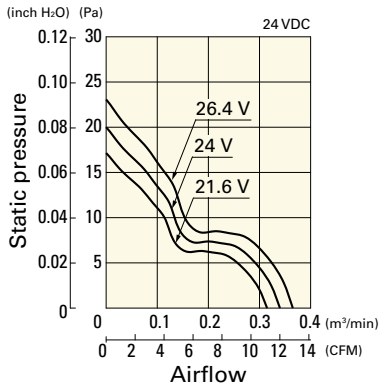

**Dimensions (unit: mm)** (With pulse sensor with PWM control function)

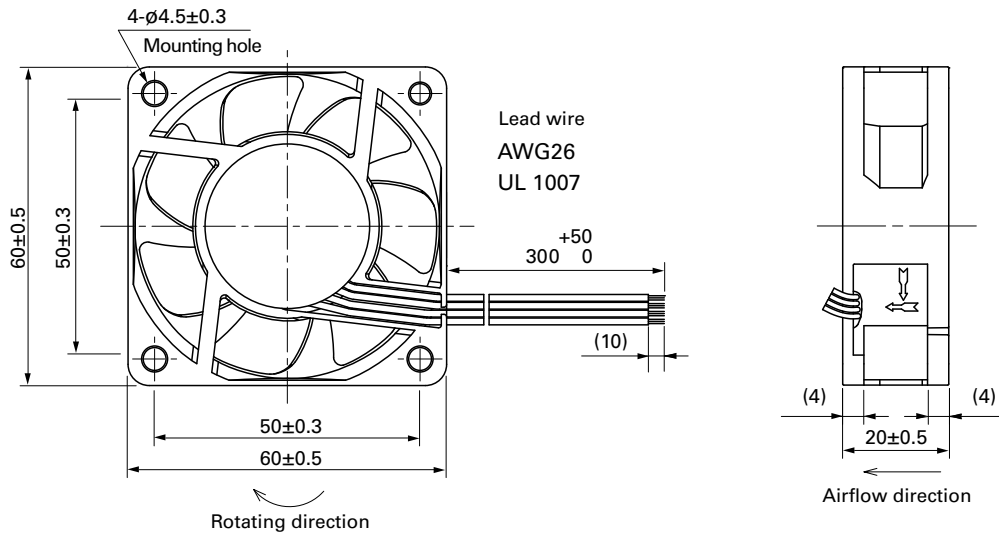

**Reference Dimensions of Mounting Holes and Vent Opening (unit: mm)**

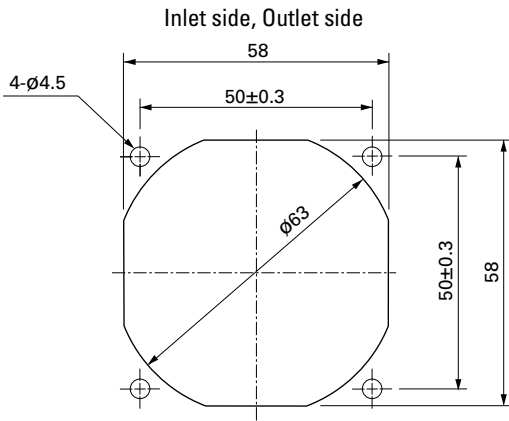

**Options**

Finger guards

page: p. 513

Model no.: 109-139E, 109-139H

Resin finger guards

page: p. 520

Model no.: 109-1003G

Resin filter kits

page: p. 521

Model no.: 109-1003F13 (13PPI), 109-1003F20 (20PPI),  
109-1003F30 (30PPI), 109-1003F40 (40PPI)