

PLEASE CHECK WWW.MOLEX.COM FOR LATEST PART INFORMATION

Part Number: [0432026104](#)
Status: **Active**
Overview: [Modular Jacks and Plugs](#)
Description: Modular Jack, Right Angle, Low Profile, 6/4

Documents:

3D Model	Packaging Specification PK-43202-003 (PDF)
Drawing (PDF)	Test Summary TS-43202-002 (PDF)
Product Specification PS-43202-001 (PDF)	RoHS Certificate of Compliance (PDF)

Agency Certification

CSA	LR19980
UL	E107635

General

Product Family	Modular Jacks/Plugs
Series	43202
Comments	Enhanced panel grounding tabs
Component Type	PCB Jack
Magnetic	No
Overview	Modular Jacks and Plugs
Performance Category	3, 4
Power over Ethernet (PoE)	N/A
Product Name	RJ11
UPC	800753576445

Physical

Color - Resin	Black
Durability (mating cycles max)	500
Flammability	94V-0
Inverted / Top Latch	No
Jack Height	11.58mm
Lightpipes/LEDs	None
Material - Metal	Phosphor Bronze
Material - Plating Mating	Gold
Material - Plating Termination	Tin
Material - Resin	High Temperature Thermoplastic
Net Weight	2.218/g
Orientation	Right Angle (Side Entry)
PCB Retention	Yes
PCB Thickness - Recommended	1.60mm
Packaging Type	Tray
Pitch - Mating Interface	1.02mm
Pitch - Termination Interface	1.27mm
Plating min - Mating	1.270µm
Plating min - Termination	2.540µm
Ports	1
Positions / Loaded Contacts	6/4
Surface Mount Compatible (SMC)	Yes
Temperature Range - Operating	-40°C to +85°C
Termination Interface: Style	Through Hole
Wire/Cable Type	N/A

Electrical

Current - Maximum per Contact	1.5A
Shielded	No
Voltage - Maximum	125V

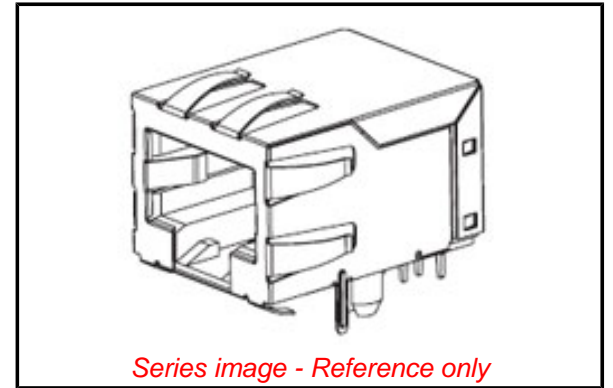

Series image - Reference only

EU ELV

Not Relevant

EU RoHS

Compliant

REACH SVHC

Not Contained Per
-ED/79/2015 (17
December 2015)

Halogen-Free

Status

Not Low-Halogen

Need more information on product environmental compliance?

Email productcompliance@molex.com
Please visit the [Contact Us](#) section for any non-product compliance questions.

China ROHS
ELV

Green Image
Not Relevant

Search Parts in this Series

[43202 Series](#)

Mates With

FCC 68 Plugs

Solder Process Data

Duration at Max. Process Temperature (seconds)	005
Lead-free Process Capability	WAVE
Max. Cycles at Max. Process Temperature	001
Process Temperature max. C	260

Material Info**Reference - Drawing Numbers**

Packaging Specification	PK-43202-003
Product Specification	PS-43202-001, RPS-43202-002
Sales Drawing	SDA-43202
Test Summary	TS-43202-002

This document was generated on 06/10/2016

PLEASE CHECK WWW.MOLEX.COM FOR LATEST PART INFORMATION