

# PE99D Series 3.3 V PECL Clock Oscillators

February 2016



- Pletronics' PE99D Series is a quartz crystal controlled precision square wave generator with a PECL output.
- The package is designed for high density surface mount designs.
- Low cost mass produced oscillator.
- Tape and Reel or cut tape packaging.
- 5 x 7 mm LCC Ceramic Package
- Enable/Disable Function on pad 1
- Output frequency is synthesized.
- Low Jitter

**Pletronics Inc. certifies this device is in accordance with the RoHS 6/6 (2011/65/EC) and WEEE (2002/96/EC) directives.**

Pletronics Inc. guarantees the device does not contain the following:  
 Cadmium, Hexavalent Chromium, Lead, Mercury, PBB's, PBDE's  
 Weight of the Device: 0.16 grams  
 Moisture Sensitivity Level: 1 As defined in J-STD-020D.1  
 Second Level Interconnect code: e4

## Absolute Maximum Ratings:

Parameter	Unit
V <sub>CC</sub> Supply Voltage	-0.5V to +4.6V
V <sub>i</sub> Input Voltage	-0.5V to V <sub>CC</sub> + 0.5V
V <sub>o</sub> Output Voltage	-0.5V to V <sub>CC</sub> + 0.5V
I <sub>o</sub> Output Current	-50mA

## Thermal Characteristics

The maximum die or junction temperature is 155°C  
 The thermal resistance junction to board is 30 to 50°C/Watt depending on the solder pads, ground plane and construction of the PCB.

**Part Number:**

PE99	45	D	E	V	-125.0M	-XX	
							<b>Packaging code or blank</b> <b>T250</b> = 250 per Tape and Reel <b>T500</b> = 500 per Tape and Reel <b>T1K</b> = 1000 per Tape and Reel
							<b>Frequency in MHZ</b>
							<b>Supply Voltage V<sub>CC</sub></b> <b>V</b> = 3.3V ± 10%
							<b>Temperature Range</b> <b>blank</b> = -10 to +70°C <b>C</b> = -20 to +70°C <b>E</b> = -40 to +85°C
							<b>Series Model</b>
							<b>Frequency Stability</b> <b>45</b> = ± 50 ppm <b>44</b> = ± 25 ppm <b>20</b> = ± 20 ppm
							<b>Series Model</b>

**Part Marking:**

**PLE PE99**  
**FF.FFF M**  
**• YMDXX**

**Marking Legend:**

PLE = Pletronics  
 FF.FFF M = Frequency in MHz  
 YMD = Date of Manufacture (year-month-day)  
 All other marking is internal factory codes

**Codes for Date Code YMD**

Code	4	5	6	7	8	Code	A	B	C	D	E	F	G	H	J	K	L	M
Year	2014	2015	2016	2017	2018	Month	JAN	FEB	MAR	APR	MAY	JUN	JUL	AUG	SEP	OCT	NOV	DEC

Code	1	2	3	4	5	6	7	8	9	A	B	C	D	E	F	G
Day	1	2	3	4	5	6	7	8	9	10	11	12	13	14	15	16
Code	H	J	K	L	M	N	P	R	T	U	V	W	X	Y	Z	
Day	17	18	19	20	21	22	23	24	25	26	27	28	29	30	31	

## Electrical Specification for 3.30V $\pm 10\%$ over the specified temperature range and the frequency range of 10.9 MHz to 766 MHz and 876 MHz to 1,175MHz

Item	Min	Max	Unit	Condition	
Frequency Accuracy	"45"	-50	+50	ppm	For all supply voltages, load changes, aging for 1 year, shock, vibration and temperatures
	"44"	-25	+25		
	"20"	-20	+20		
Output Waveform	PECL / ECL				
Output High Level	2.12	2.49	volts	Referenced to Ground, $V_{CC} = 3.3 V$	
	0.82	1.19	volts	Referenced to termination voltage, $V_{CC} = 3.3 V$	
	-1.18	-0.81	volts	Referenced to $V_{CC}$ , $V_{CC} = 3.3 V$	
Output Low Level	1.83	1.99	volts	Referenced to Ground, $V_{CC} = 3.3 V$	
	0.53	0.69	volts	Referenced to termination voltage, $V_{CC} = 3.3 V$	
	-1.47	-1.31	volts	Referenced to $V_{CC}$ , $V_{CC} = 3.3 V$	
Output Peak to Peak Level	0.405	1.076	volts		
Output Symmetry	47	53	%	at 50% point of $V_{CC}$ (See load circuit)	
Jitter	-	0.6	pS RMS	12 KHz to 20 MHz from the output frequency	
	-	2.8	pS RMS	10 Hz to 20 MHz from the output frequency	
Output $T_{RISE}$ and $T_{FALL}$	100	300	pS	$V_{th}$ is 20% and 80% of waveform	
$V_{CC}$ Supply Current ( $I_{CC}$ )	-	90	mA		
Enable/Disable Internal Pull-up	50	-	Kohm	to $V_{CC}$	
V disable	-	0.8	volts	Referenced to pad 3	
V enable	2.00	-	volts	Referenced to pad 3	
Output leakage	$V_{OUT} = V_{CC}$	-50	+50	uA	Pad 1 low, device disabled
	$V_{OUT} = 0V$	-50	+50		
Enable time	-	10	nS	Time for output to reach a logic state	
Disable time	-	10	nS	Time for output to reach a high Z state	
Start up time	-	5	mS	Time for output to reach specified frequency	
Operating Temperature Range	-10	+70	°C	Standard Temperature Range	
	-20	+70	°C	Extended Temperature Range "C" Option	
	-40	+85	°C	Extended Temperature Range "E" Option	
Storage Temperature Range	-55	+125	°C		

Specifications with Pad 1 E/D open circuit or connected to  $V_{CC}$

## Typical Phase-Noise Response

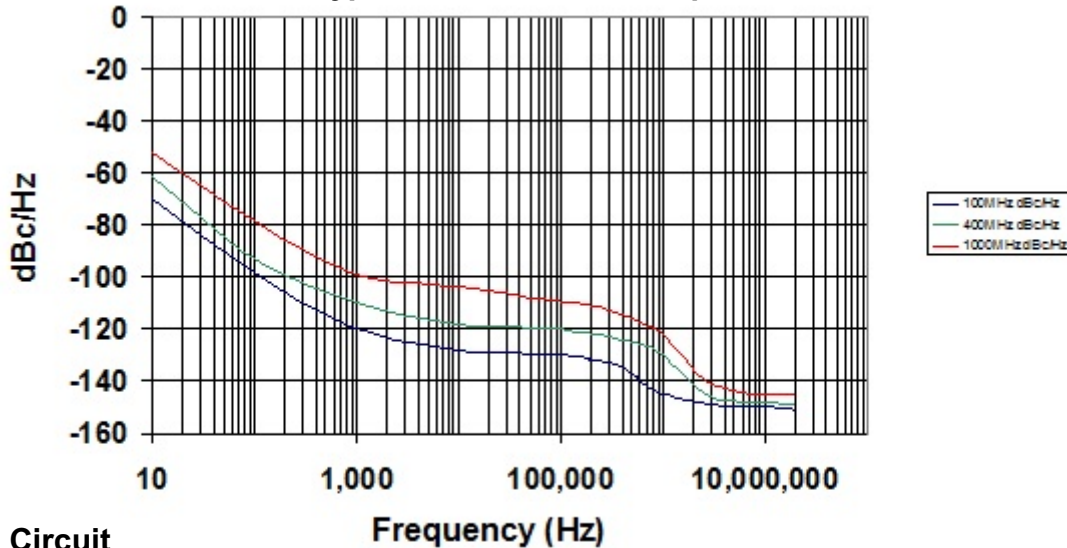

## Load Circuit

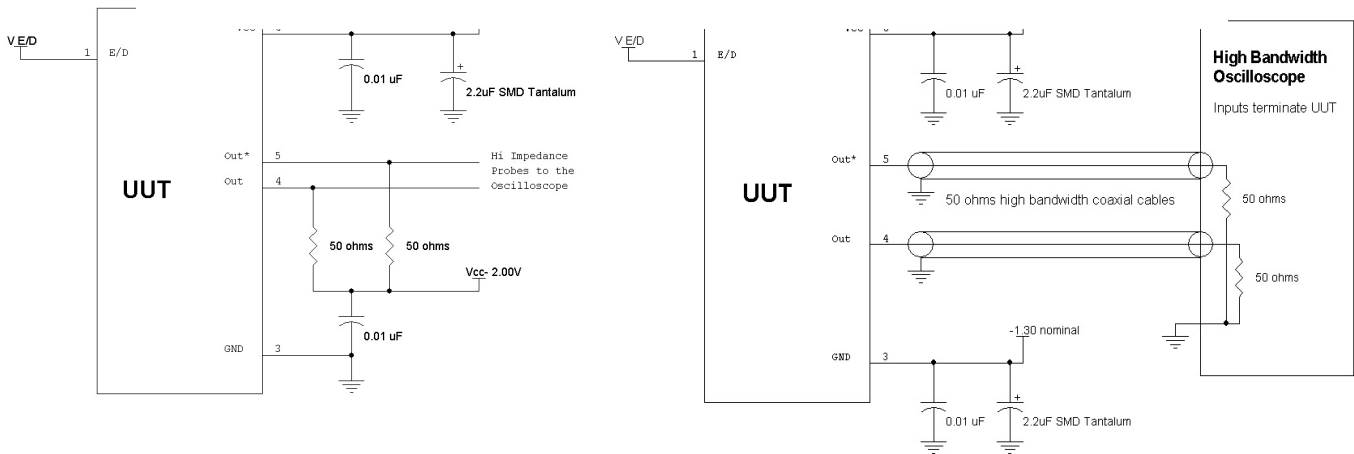

## Test Waveform

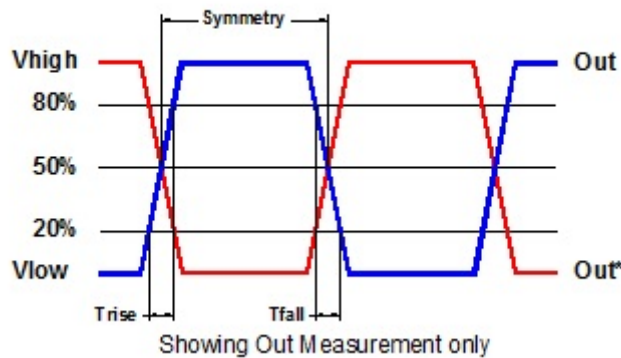

## Reliability: Environmental Compliance

Parameter	Condition
Mechanical Shock	MIL-STD-883 Method 2002, Condition B
Vibration	MIL-STD-883 Method 2007, Condition A
Solderability	MIL-STD-883 Method 2003
Thermal Shock	MIL-STD-883 Method 1011, Condition A





## ESD Rating

Model	Minimum Voltage	Conditions
Human Body Model	2000	MIL-STD-883 Method 3115
Charged Device Model	1500	JESD 22-C101

## Package Labeling

Label is 1" x 2.6" (25.4mm x 66.7mm)  
Font is Courier New  
Bar code is 39-Full ASCII

Label is 1" x 2.6" (25.4mm x 66.7mm)  
Font is Arial

P/N:		
	PE9944DV-312.50M	
Customer P/N:		
	12345678	
Qty:		D/C 
	1000	7AA-BT

### RoHS Compliant

2nd Lvl Interconnect

Category=e4

Max Safe Temp=260C for 10s 2X Max

## Mechanical:

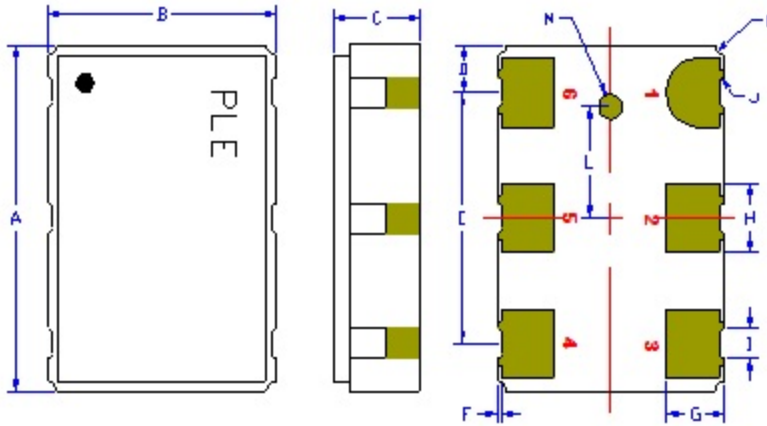

	Inches	mm
A	0.276 $\pm$ 0.006	7.00 $\pm$ 0.15
B	0.197 $\pm$ 0.006	5.00 $\pm$ 0.15
C	0.067 $\pm$ 0.010	1.70 $\pm$ 0.25
D <sup>1</sup>	0.038	0.96
E <sup>1</sup>	0.200	5.08
F <sup>1</sup>	0.004	0.10
G <sup>1</sup>	0.050	1.27
H <sup>1</sup>	0.055	1.40
I <sup>1</sup>	0.024	0.60
J <sup>1</sup>	0.004r	0.10r
K <sup>1</sup>	0.008r	0.20r
L <sup>1</sup>	0.089	2.25
M <sup>1</sup>	0.010r	0.25r

### Contacts:

Gold 11.8 to 39.4  $\mu$ inches (0.3 to 1.0  $\mu$ m)  
over  
Nickel 50 to 350  $\mu$ inches (1.27 to 8.89  $\mu$ m)

<sup>1</sup> Typical dimensions

Not to Scale

Center metallized pad "M" on the base is not internally connected.

Pad	Function	Note
1	Output Enable/Disable	When this pad is not connected the oscillator shall operate. When this pad is <0.80 volts, the output will be inhibited (high impedance state.) Recommend connecting this pad to V <sub>cc</sub> if the oscillator is to be always on.
2	No connect	The pad can be connected to V <sub>cc</sub> , Ground or left open. This pad is internally connected.
3	Ground (GND)	
4	Output	Both outputs must be terminated and biased for proper operation. The ideal termination is 50 ohms connected to 2.0V below the Supply Voltage. The outputs become a High Z when disabled and the voltage level is determined by the termination circuitry.
5	Output*	
6	Supply Voltage (V <sub>cc</sub> )	Recommend connecting appropriate power supply bypass capacitors as close as possible.

## Reflow Cycle (typical for lead free processing)

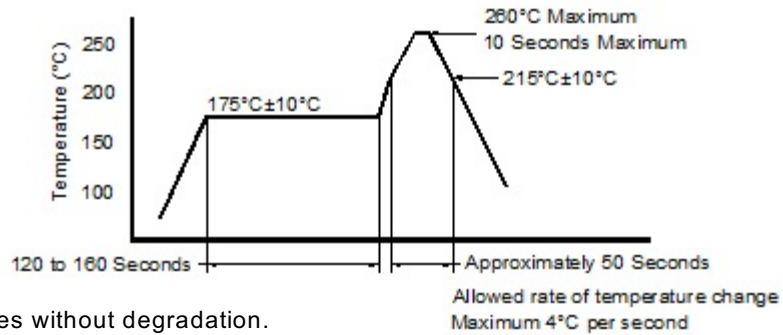

The part may be reflowed 3 times without degradation.

## Tape and Reel: available for quantities of 250 to 1000 per reel, cut tape for < 250

Constant Dimensions Table 1								
Tape Size	D0	D1 Min	E1	P0	P2	S1 Min	T Max	T1 Max
8mm	1.5	1.0	1.75	4.0	2.0 ±0.05	0.6	0.6	0.1
12mm		1.5			2.0 ±0.1			
16mm		+0.1 -0.0			1.5			
24mm		1.5			1.5			

Variable Dimensions Table 2							
Tape Size	B1 Max	E2 Min	F	P1	T2 Max	W Max	Ao, Bo & Ko
16 mm	12.1	14.25	7.5 ± 0.1	8.0 ± 0.1	8.0	16.3	Note 1

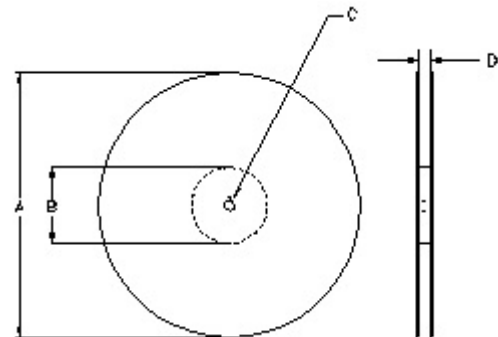

Note 1: Embossed cavity to conform to EIA-481-B      Dimensions in mm      Not to scale

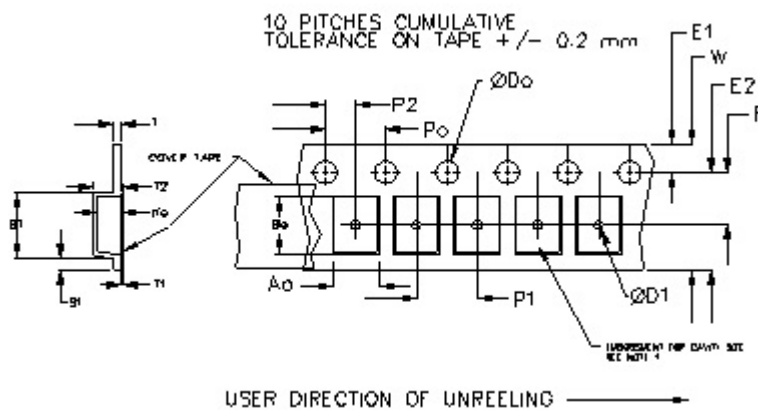

		REEL DIMENSIONS			Tape Width
A	inches	7.0	10.0	13.0	
	mm	177.8	254.0	330.2	
B	inches	2.50	4.00	3.75	
	mm	63.5	101.6	95.3	
C	mm	13.0 +0.5 / -0.2			
D	mm	16.4 +2.0 -0.0	16.4 +2.0 -0.0	16.4 +2.0 -0.0	16.0
	mm	---	---	24.4 +2.0 -0.0	24.0
	mm	---	---	32.4 +2.0 -0.0	32.0

Reel dimensions may vary from the above

## IMPORTANT NOTICE

Pletronics Incorporated (PLE) reserves the right to make corrections, improvements, modifications and other changes to this product at anytime. PLE reserves the right to discontinue any product or service without notice. Customers are responsible for obtaining the latest relevant information before placing orders and should verify that such information is current and complete. All products are sold subject to PLE's terms and conditions of sale supplied at the time of order acknowledgment.

PLE warrants performance of this product to the specifications applicable at the time of sale in accordance with PLE's limited warranty. Testing and other quality control techniques are used to the extent PLE deems necessary to support this warranty. Except where mandated by specific contractual documents, testing of all parameters of each product is not necessarily performed.

PLE assumes no liability for application assistance or customer product design. Customers are responsible for their products and applications using PLE components. To minimize the risks associated with the customer products and applications, customers should provide adequate design and operating safeguards.

PLE products are not designed, intended, authorized or warranted to be suitable for use in life support applications, devices or systems or other critical applications that may involve potential risks of death, personal injury or severe property or environmental damage. Inclusion of PLE products in such applications is understood to be fully at the risk of the customer. Use of PLE products in such applications requires the written approval of an appropriate PLE officer. Questions concerning potential risk applications should be directed to PLE.

PLE does not warrant or represent that any license, either express or implied, is granted under any PLE patent right, copyright, artwork or other intellectual property right relating to any combination, machine or process which PLE product or services are used. Information published by PLE regarding third-party products or services does not constitute a license from PLE to use such products or services or a warranty or endorsement thereof. Use of such information may require a license from a third party under the patents or other intellectual property of the third party, or a license from PLE under the patents or other intellectual property of PLE.

Reproduction of information in PLE data sheets or web site is permissible only if the reproduction is without alteration and is accompanied by associated warranties, conditions, limitations and notices. Reproduction of this information with alteration is an unfair and deceptive business practice. PLE is not responsible or liable for such altered documents.

Resale of PLE products or services with statements different from or beyond the parameters stated by PLE for that product or service voids all express and implied warranties for the associated PLE product or service and is an unfair or deceptive business practice. PLE is not responsible for any such statements.

### Contacting Pletronics Inc.

Pletronics Inc.  
19013 36<sup>th</sup> Ave. West  
Lynnwood, WA 98036-5761 USA

Tel: 425-776-1880  
Fax: 425-776-2760  
E-mail: [ple-sales@pletronics.com](mailto:ple-sales@pletronics.com)  
URL: [www.pletronics.com](http://www.pletronics.com)

Copyright © 2005, 2006, 2008, 2010, Pletronics Inc.