

PLEASE CHECK WWW.MOLEX.COM FOR LATEST PART INFORMATION

Part Number: [0510481400](#)
Status: **Active**
Description: 2.00mm Pitch Cable Holder, Vertical, Low Profile, for Ribbon Cable, 14 Circuits

Documents:

[3D Model](#) [RoHS Certificate of Compliance \(PDF\)](#)
[Drawing \(PDF\)](#)

General

Product Family Ribbon Cable / Wire Trap Connectors
 Series [51048](#)
 Component Type One Piece
 Glow-Wire Capable No
 Product Name Board-in, Cable Holder
 UPC 800753750548

Physical

Circuits (Loaded) 14
 Color - Resin Natural
 Entry Angle Vertical
 Lock to Mating Part None
 Material - Plating Mating N/A
 Material - Resin Nylon
 Net Weight 293.700/mg
 Number of Rows 1
 PCB Retention Yes
 PCB Thickness - Recommended 1.60mm
 Packaging Type Bag
 Pitch - Mating Interface 2.00mm
 Pitch - Termination Interface 2.00mm
 Polarized to Mating Part N/A
 Polarized to PCB No
 Stackable No
 Surface Mount Compatible (SMC) No
 Temperature Range - Operating -40°C to +105°C
 Wire Insulation Diameter 1.60mm max.
 Wire Size AWG 26
 Wire/Cable Type Ribbon Cable

Electrical

Current - Maximum per Contact N/A
 Voltage - Maximum N/A

Material Info

Reference - Drawing Numbers

Sales Drawing SD-51048-001

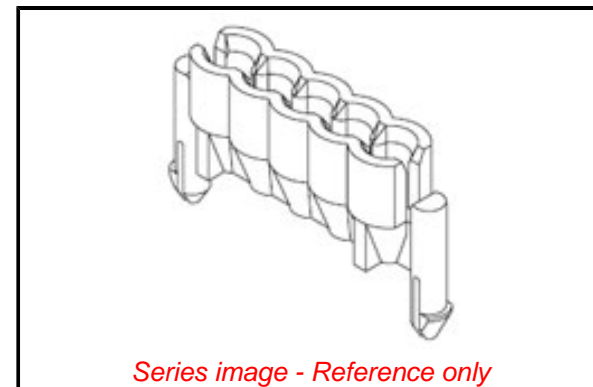

EU ELV

Not Relevant

EU RoHS

Compliant

REACH SVHC

Not Contained Per
 -ED/01/2018 (15
 January 2018)

Halogen-Free

Status

Low-Halogen

**Need more information on product
 environmental compliance?**

Email productcompliance@molex.com
 Please visit the [Contact Us](#) section for any
 non-product compliance questions.

China ROHS	Green Image
ELV	Not Relevant
RoHS Phthalates	Not Contained

Search Parts in this Series

[51048 Series](#)

Mates With

N/A

Use With

Topcoated Ribbon Cable